

Owner's Manual

Covering **The Big Oven**[™] ACF4255A and **The Big Oven**[™] ACF4265A

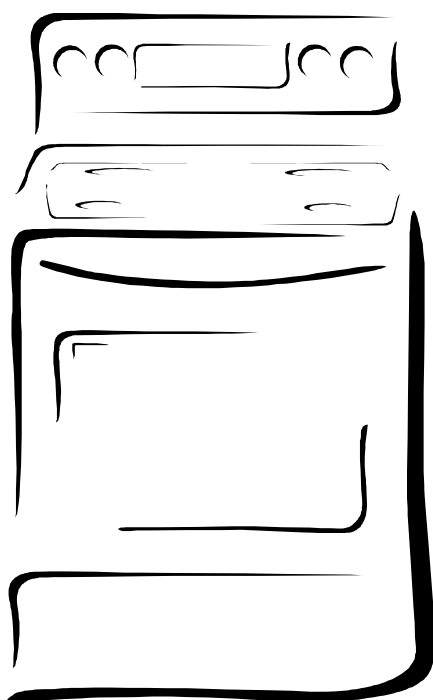

The Big Oven[™]

Electric Smoothtop Range

Keep instructions for future reference.

Be sure manual stays with range.

Contents

Important Safety Information	3
Cooking on the Smoothtop	6
Cookware Suggestions	8
Oven Cooking Methods	9
Before Using the Oven	10
Features	11
Displays and Signals	13
Using the Oven Control	14
Cooking	
Baking	19
Broiling	22
Roasting	23
Braising	24
Care and Cleaning	25
Troubleshooting	29
Amana Warranty	32



Thank you for buying an Amana Range!

Please take the time to complete the registration card and return promptly. If the registration card is missing, call Amana Consumer Affairs Department. When contacting Amana, provide product information from serial plate found on upper right hand corner of storage door opening:

Model Number _____
Manufacturing (P) Number _____
Serial Number (S/N) _____
Purchase Date _____
Dealer Name _____
Dealer Address _____
Dealer Phone _____

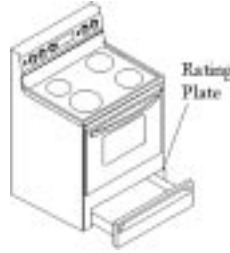

Keep this manual and your sales receipt together in a safe place for future reference or if warranty service is required.

For answers to questions or to locate an authorized servicer, call **1-800-NAT-LSVC (1-800-628-5782) inside USA or 319-622-5511 outside USA. Warranty service must be performed by an authorized servicer.** Amana Appliances also recommends contacting an authorized servicer if service is required after warranty expires.

Asure™ Extended Service Plan

Amana Appliances offers long-term service protection for this new range. Asure™ Extended Service Plan, covering functional parts, labor, and travel charges, is specially designed to supplement a strong warranty. Call 1-800-528-2682 for information.

Parts and Accessories

Purchase replacement parts and additional accessories by phone. To order accessories for your Amana product, call 1-800-843-0304 inside USA or 319-622-5511 outside USA.

Save Time and Money

If something seems unusual, please check “Troubleshooting” section, which is designed to help you solve problems before calling service. If you have a question, call us at **(800) 843-0304** or write us at:

Consumer Affairs Department
Amana Appliances
2800 - 220th Trail
Amana, Iowa 52204

Remember to include model number of your appliance and your phone number.

Questions on cooking, cleaning or usage?

Refer to

Product Assistance at **www.amana.com**

or

call Consumer Affairs at **1-800-843-0304**

What You Need to Know About Safety Instructions

Warning and Important Safety Instructions appearing in this manual are not meant to cover all possible conditions and situations that may occur. Common sense, caution, and care must be exercised when installing, maintaining, or operating range.

Always contact your dealer, distributor, service agent, or manufacturer about problems or conditions you do not understand.

Recognize Safety Symbols, Words, Labels



DANGER

DANGER—Immediate hazards which **WILL** result in severe personal injury or death.



WARNING

WARNING—Hazards or unsafe practices which **COULD** result in severe personal injury or death.



CAUTION

CAUTION—Hazards or unsafe practices which **COULD** result in minor personal injury or product or property damage.

IMPORTANT SAFETY INFORMATION

WARNING

To reduce risk of the appliance tipping, it must be secured by a properly installed anti-tip bracket. To verify bracket has been installed properly, remove the storage drawer or panel and look under the range with a flashlight. Bracket must be engaged in the rear corner of the range.

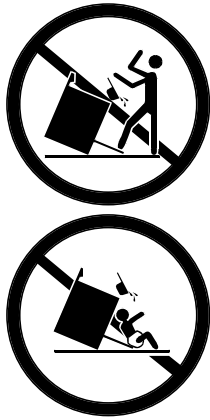

- ALL RANGES CAN TIP
- INJURY TO PERSONS COULD RESULT
- INSTALL ANTI-TIP BRACKET PACKED WITH RANGE
- REFER TO INSTALLATION INSTRUCTIONS

WARNING

To avoid personal injury, do not sit, stand or lean on oven door or oven (storage) drawer.

WARNING

To avoid risk of electrical shock, personal injury, or death, verify your range has been properly grounded and always disconnect it from main power supply before servicing.

California Safe Drinking Water and Toxic Enforcement Act (Proposition 65)

The Governor of California is required to publish a list of substances known to the state of California to cause cancer or reproductive harm and requires businesses to warn customers of potential exposures to such substances.

Some appliances contain or produce a chemical or chemicals which can cause death or serious illness and which are known to the State of California to cause cancer, birth defects, or other reproductive harm. To reduce the risk from substances during the self-clean cycle make sure this appliance is installed, operated, and maintained according to the manufacturer's instructions.

CAUTION

DO NOT TOUCH SURFACE ELEMENTS OR AREAS NEAR ELEMENTS—Surface elements may be hot though they are normal in color. Areas near surface elements may become hot enough to cause burns. During and after use, do not touch, or let clothing or other flammable materials contact surface elements or areas near surface elements until they have had enough time to cool. These areas include the rangetop and backguard.

CAUTION

DO NOT TOUCH HEATING ELEMENTS OR INTERIOR SURFACES OF OVEN—Oven heating elements may be hot though they are normal in color. Interior surfaces of an oven may become hot enough to cause burns. During and after use, do not touch, or let clothing or other flammable materials touch heating elements or interior surfaces of oven until they have had enough time to cool. Other range surfaces that may become hot enough to cause burns are the oven door, oven cavity, and oven vent.

CAUTION

- To avoid fire or smoke damage,
- remove any flammable materials from storage drawer. Items like plastic containers and paper manuals can melt or burn.
 - clean excess spills before starting a self clean cycle.

SAVE THESE INSTRUCTIONS

IMPORTANT SAFETY INFORMATION (cont'd)

ALL APPLIANCES

1. Proper Installation—Be sure your appliance is properly installed and grounded by a qualified technician.
2. Never Use Your Appliance for Warming or Heating the Room.
3. Do Not Leave Children Alone—Children should not be alone or unattended in the area where the appliance is in use. They should never be allowed to sit or stand on any part of the appliance.
4. Wear Proper Apparel—Loose fitting or hanging garments should never be worn while using appliance.
5. User Servicing—Do not repair or replace any part of the appliance unless specifically recommended in the manual. All other servicing should be referred to a qualified technician.
6. Storage in or on Appliance—Flammable materials (including paper and plastic) should not be stored in an oven, its storage drawer or near surface units.
7. Do Not Use Water On Grease Fires—Smother fire or flame, or use dry chemical or foam-type extinguisher.
8. Use Only Dry Potholders—Moist or damp potholders on hot surfaces may result in burns from steam. Do not let potholder touch elements. Do not use a towel or other bulky cloth.



SURFACE COOKING UNITS

1. Use Proper Pan Size—
This appliance is equipped with one or more surface units of different sizes. Select utensils having flat bottoms large enough to cover the surface unit heating element. The use of undersized utensils will expose a portion of the heating element to direct contact and may result in ignition of clothing. Use of oversized utensils concentrates heat on cooking surface and can cause damage to range. Proper relationship of utensil to burner improves efficiency.
2. Never Leave Surface Units Unattended—Boilover causes smoking and greasy spillovers that may ignite.
3. Glazed Cooking Utensils—Only certain types of glass, ceramic, earthenware, or other glazed utensils are suitable for rangetop service without breaking due to sudden change in temperature.
4. Utensil Handles Should Be Turned Inward and Not Extended Over Adjacent Surface Units—To reduce the risk of burns, ignition of flammable materials, and spillage due to unintentional contact with the utensil, the handle of a utensil should be positioned so that it is turned inward, and does not extend over adjacent surface units.

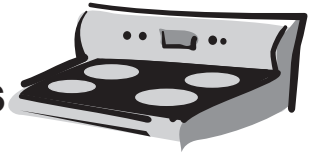

GLASS/CERAMIC COOKING SURFACES

1. Do Not Cook on Broken Cooktop—If cooktop should break, cleaning solutions and spillovers may penetrate the broken cooktop and create a risk of electrical shock. Contact a qualified technician immediately.
2. Clean Cooktop With Caution—If a wet sponge or cloth is used to wipe spills on a hot cooking area, be careful to avoid a steam burn. Some cleaners can produce noxious fumes if applied to a hot surface.



CAUTION

Do not store items of interest to children in cabinets above a range or on the backguard of a range—children climbing on the range to reach items could be seriously injured.

SAVE THESE INSTRUCTIONS

IMPORTANT SAFETY INFORMATION (cont'd)

OVENS

1. Use Care When Opening Door—Let hot air or steam escape before removing or replacing food.
2. Do Not Heat Unopened Food Containers—Build-up of pressure may cause container to burst and result in injury.
3. Keep Oven Vent Ducts Unobstructed.
4. Placement of Oven Racks—Always place oven racks in desired location while oven is cool. If rack is removed while oven is hot, do not let potholder contact hot heating element in oven.
5. Protective Liners—Do not use aluminum foil to line oven racks or oven bottoms. Improper installation of these liners may result in a risk of electrical shock, or fire.

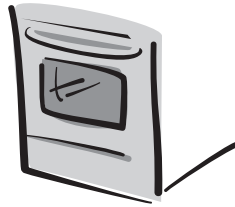

SELF-CLEANING OVENS

1. Do Not Clean Door Gasket—The door gasket is essential for a good seal. Care should be taken not to rub, damage, or move the gasket.
2. Do Not Use Oven Cleaners—No commercial oven cleaner or oven liner protective coating of any kind should be used in or around any part of the liner.
3. Clean Only Parts Listed in Manual
4. Before Self-Cleaning the Oven—Remove broiler pan, oven racks, and other utensils.
5. Remove All Items From Rangetop and Backguard.

VENTILATION HOODS

1. Clean Ventilating Hoods Frequently—Grease should not be allowed to accumulate on hood or filter.
2. When flaming foods under the hood, turn the fan on.

In Case of Fire

Fires can occur as a result of over cooking or excessive grease. Though a fire is unlikely, if one occurs, proceed as follows:



Surface Element Fire

1. Smother the fire with a nonflammable lid or baking soda, or use a Class ABC or BC extinguisher. Not water. Not salt. Not flour.
2. As soon as it is safe to do so, turn the surface controls to *OFF*.
3. As an added precaution, turn off power at main circuit breaker or fuse box.
4. If there is any damage to components, call an authorized Amana servicer before using range.

Oven Fires

1. If you see smoke from your oven, do not open oven.
2. Turn oven off.
3. As an added precaution, turn off power at main circuit breaker or fuse box.
4. Turn on vent to remove smoke.
5. Allow food or grease to burn itself out in oven.
6. If smoke and fire persist, call fire department.
7. If there is any damage to components, call an authorized servicer before using range.



Precautions

- Do not cook food directly on rangetop surface, always use cookware.
- Do not mix household cleaning products. Chemical mixtures may interact with objectionable or even hazardous results.
- Do not put plastic items on warm cooking areas. They may melt and stick.
- Do not lift or move range by grasping oven door handle. This can result in window glass breaking or shattering.
- Do not slide rough metal objects across rangetop surface. Scratching or metal marking can result.
- Do not leave fat heating unless you remain nearby. Fat can ignite if overheated by spilling onto hot surfaces.
- Do not allow pots to boil dry as this can cause damage to cooking surface and pan.
- Do not use rangetop surface as a cutting board.
- Do not use range for storage or as a display counter.

SAVE THESE INSTRUCTIONS

Cooking on the Smoothtop

Cooking Safely with Surface Elements

WARNING

To avoid risk of serious personal injury, property damage, or fire, do not leave surface elements unattended while in operation. Grease and spillovers can ignite causing a fire.

WARNING

To avoid risk of electrical shock or serious personal injury,

- never cook on a broken smoothtop cooking surface. Spillovers can penetrate broken surface and cause electric shock.
- never clean broken cooktop. Cleaners can penetrate broken surface and cause electric shock.

If smoothtop cooking surface breaks, discontinue use, turn off power at circuit breaker or household fuse and notify an authorized servicer immediately.

WARNING

To avoid serious personal injury, do not use a damp or wet cloth to clean up spills on a hot or warm cooktop. Moist or damp cloths on hot surfaces may result in burns from steam.

Setting Surface Element Controls

Push in and turn the surface element control knobs in either direction to turn on the surface elements. Surface elements are located under the ceramic cooking surface and radiate heat through the cooktop. It is normal for the element to cycle on and off during heating. The controls have infinite settings between SIM and HI for fine temperature control.

1. Push in and turn surface element control to desired setting.
2. When finished cooking, turn control to OFF position.
3. It is normal for some cooktops to have a greenish tint while cooling or heating.

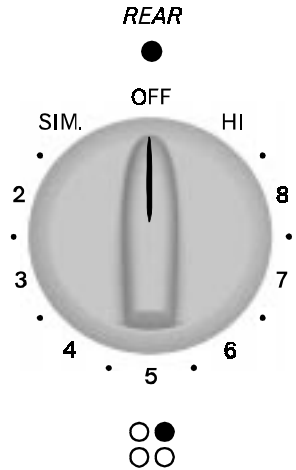

SURFACE ELEMENT CONTROL SETTINGS	WHEN TO USE SETTING
SIM	Use to prepare food at less than boiling temperatures or to simmer.
5	Use to maintain boiling of larger amounts of food, low temperature frying.
HI	Use to bring food to boiling temperatures. When food is boiling temperature setting should be reduced to LO through MED.

Dual Surface Elements

Dual surface elements have an inner and outer element that can be set according to your pan size. The outer edge of your pan should always cover the element graphic, with a maximum overhang of 1 inch. To use inner and outer element simultaneously, press switch to LARGE position. To use inner element only, press switch to SMALL position.

DUAL ELEMENT

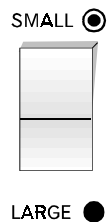

TheBigQueen

Indicator Lights

Surface element operation is indicated by an indicator light that glows when the element is turned on. The location and number of indicator lights vary with each model. **After a surface control is turned off, the surface indicator light will continue to glow until surface elements have cooled to approximately 145°F. The length of time the light remains on will vary. If there is more than one surface element light, do not expect the lights to shut off at the same time.**

After you cook...

...remember to establish a cleaning routine for your smoothtop. Cooktops can be sensitive to certain cooking spillovers. Unlike conventional ranges, smoothtops should not be cleaned with a wet dishcloth when wiping down other counters. Daily care is quick, easy and can prevent damage. To purchase Amana recommended cleaning products, contact our Consumer Affairs department at (800) 843-0304.

Cooking on the Smoothtop (cont'd)

Using the Warming Zone

Your new range is equipped with a convenient warming zone. The warming zone is designed to keep hot foods hot until serving time. When cooking such foods as pancakes, fried chicken, or even stir-fry the warming zone can keep cooked foods hot as other portions are cooked.

All food placed on the warming zone should be covered with aluminum foil or a lid to maintain quality. For best results, when warming pastries or breads, cover should have a vent to allow moisture to escape. **Do not** use plastic wrap to cover food. Plastic wrap could melt onto the surface and be very difficult to clean.

Cookware should be restricted to utensils designed for use with a smoothtop cooktop. Cookware used on the warming zone should also not exceed the pattern of the element by more than one inch, or be taller than six inches to allow easy access to the oven control.

1. Push in and turn surface element control to desired setting. Warming zone element approximate temperatures are:

- 145°F on 1 setting
- 175°F on 3 setting
- 205°F on 5 setting
- 250°F on 7 setting
- 325°F on 9 setting

Temperatures depend on the utensil used and the food being kept warm.

2. When finished with warming zone, turn control to OFF position.

Temperature Selection

To decrease the likelihood of food borne illness, hot foods should be kept at a minimum of 140°F. Use a meat thermometer to verify foods kept on the warming zone are at this temperature. Use the chart below to approximate what heat setting to begin using for a particular food. Adjust as necessary depending on the maintained temperature of the food.

Warming Zone Recommended Settings

Food Item	Heat Setting	Approximate Temperature °F (Element)
Breads/Pastries	1	145
Casseroles	1	145
Dinner Plates with Food	1	145
Eggs	1	145
Mashed Potatoes	1	145
Hamburger Casserole	3	175
Gravies	5	205
Meats	5	205
Sauces	5	205
Cream based soups	5	205
Stews	5	205
Vegetables	9	325
Fried Foods	9	325
Hot Beverages	9	325
Soups	9	325

WARMING ZONE

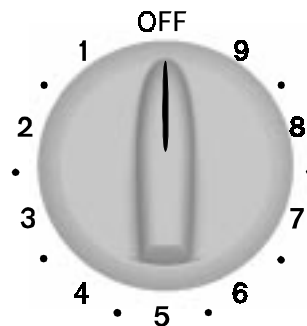

Amana
Self Clean Oven



CAUTION

Always use potholders or oven mitts when removing food from the warming zone as cookware and plates will be hot.

Warming Zone Utensil Recommendations

Because the warming zone is a part of the smoothtop cooktop, it is recommended only to use utensils designed specifically for use on the smoothtop (see Cookware Suggestions section). Using cookware not designed for use with a smoothtop may result in poor cooking performance, damage to the smoothtop, or damage to the cookware. **Cookware should not be wider than 8 inches around or taller than 6 inches in height.**

Indicator Light

The warming zone has its own indicator light. It turns on when the control is set. The indicator light will remain on after the knob is turned to an off position if the surface is still warm. When the glass of the cooktop has cooled down sufficiently (approximately 145 °F), the indicator light will then shut off.

Cookware Suggestions

What Should You Consider in Cookware?

Flat Pan Test

For best cooking results, use a pan with a flat bottom. To determine if pan has a flat bottom.

1. Rotate a ruler along bottom of pan. If pan is not flat, gaps between bottom of pan and edge of ruler can be seen.
2. A small groove or mark on a pan does not affect cooking times. However, if a pan has a gap, formed rings, or an uneven bottom, it does not cook efficiently and in some cases may not boil liquid.

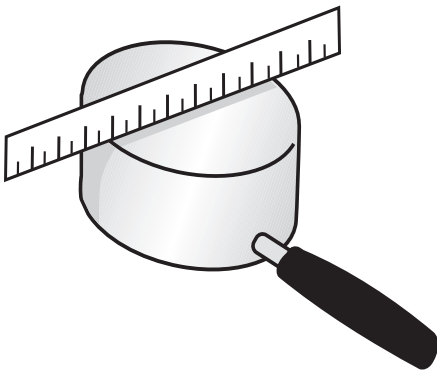

Select	Avoid
Flat bottomed cookware.	Cookware with rounded or warped bottoms.
Pans with aluminum disk bottoms.	Glass, glass-ceramic, enamel porcelain or cast iron cookware, canners or pressure cookers.
Heavy gauge metal cookware.	Light gauge metal cookware.
Handles that are secure, that are not heavy enough to tilt pan.	Cookware with loose or broken handles.
Proper pan size.	Cookware that is smaller than or greater than heating element size by 1 inch.
Flat bottomed wok	Wok with a ringstand on bottom

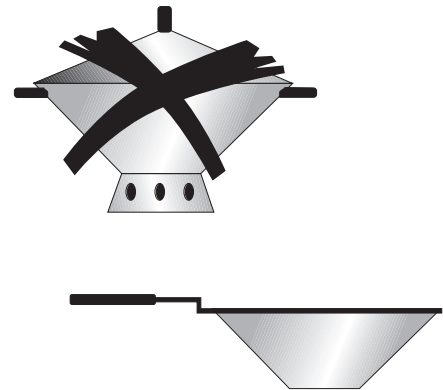
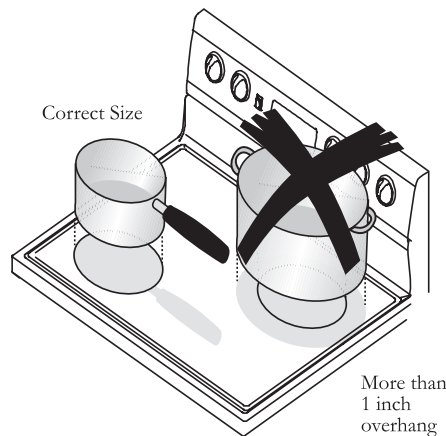

Can I can?

Canning is not recommended with any of the Amana smoothtop ranges or cooktops due to the intense heat and large cookware required to can.

The heat generated by the canning cookware overheats both the elements and the smoothtop of the range. This can cause the smoothtop to crack, cause failure of the heating elements, and can cause damage to the backguard.

Damage incurred by canning, or attempting to can, using the smoothtop cooktop is not covered under warranty.

COOKWARE MATERIAL	USES
Aluminum	Heats and cools quickly. Use for frying, braising, and roasting.
Stainless Steel	Heats and cools at moderate rate. Use for soups, sauces, vegetables, general cooking.
Copper Clad / Tin Lined	Heats and cools quickly. Use for gourmet cooking, wine sauces, egg dishes.

Oven Cooking Methods

Oven Cooking Methods

Bake

Bake (lower) and broil (upper) elements operate during bake. Bake element is not visible on oven bottom. Broil element will cycle on and off during bake and is only used to heat oven quickly and brown top of food. Broil element will not glow red during a bake cycle. Bake can be used to cook foods which are normally baked. Oven should be preheated.

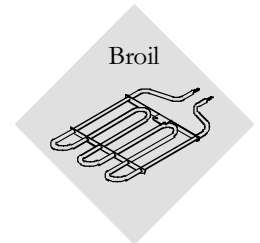
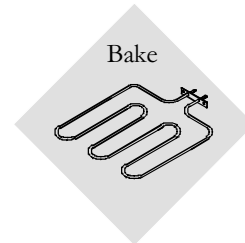

Broil

Upper element operates during broil. Broil can be used to cook foods which are normally broiled. Preheating is not required when using broil. All foods should be turned at least once except fish, which does not need to be turned.

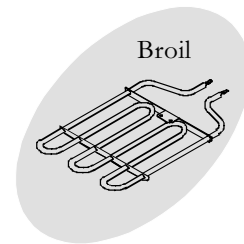

Broiling Hints

- Remove excess fat from meat before broiling. Cut edges of meat to prevent curling.
- Place food on a cold ungreased broiling pan. If pan is hot, food sticks.
- All food except fish should be turned at least one time. Begin broiling with skin side down.
- Season meat after it has browned.
- Broiling does not require preheating.
- Begin cooking using suggested rack levels in *Broiling* section to test broiler results. If food is not brown enough, cook on a higher rack position. If food is too brown, cook on a lower rack position.
- Oven door must be closed during broiling.



WARNING

Never leave oven unattended while broiling. Overcooking may result in a fire.



Need help on how to cook that meat?

For your reference we have provided meat preparation, handling safety and cooking suggestions in this manual. These recommendations are furnished by the USDA as well as several meat producer associations. See the individual sections for the information.

Before Using the Oven

Aluminum Foil

WARNING

To avoid risk of personal injury, property damage or fire, **do not** line oven bottom, racks, or broiler pan and grid with aluminum foil.

When placed on the oven bottom or racks, aluminum foil not only creates a hazard, but also affects cooking performance. To minimize spills in the oven, place a shallow pan or cookie sheet on rack underneath food items that drip or spill. The pan must not touch the oven walls, front, or back. **DO NOT** use aluminum foil, even if it is trimmed to size, as a substitute for a drip pan.



Oven Racks and Rack Positions

Your range has 6 oven rack positions to accommodate many types of cooking and cookware.

Position oven rack before turning oven on.

1. Pull rack forward to stop position.
2. Raise front edge of rack and pull until rack is out of oven.
3. Place rack in new rack position.
 - Curved edge of rack must be toward rear of oven.

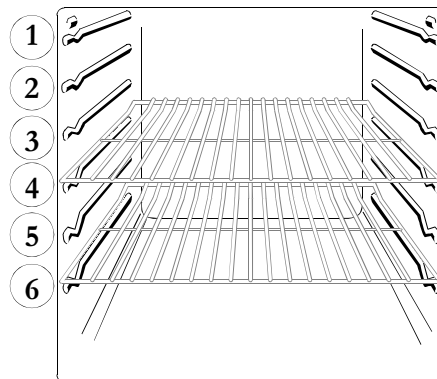

Rack Position Guidelines for Baking, Roasting and Braising

Rack Position	Food Type
2	Puff pastry products, strudels, casseroles, muffins, small pork loin and Eye of Round roast.
3	Halved chickens, whole pork tenderloin, Cornish hens, pot pies, frozen pizzas, quick breads (corn bread, biscuits)
4	Roast tenderloin of beef, whole chicken, whole pork loin, roasted vegetables such as acorn or spaghetti squash.
5	Whole turkey, capons, tip roasts and dressings
6	Large cuts of roast meats such as top round, standing rib roast, crown roast of lamb and boston butts. Baked and sweet potatoes, flat breads and cobblers.

Rack Position Guidelines for Broiling

Rack Position	Food Type
1	Boneless pork chops, boneless skinless chicken breast, fish fillets, tuna steaks.
2	1/2 to 3/4" thick beef or tuna steaks, or pork chops. London Broil.
3	1 to 1 1/2" thick steaks, 1 to 2" thick pork chops. Lobster tails.

12-hour automatic cancel

This safety feature prevents oven from continuing to operate if it has been left on for over 12 hours. If a cooking function continues longer than 12 hours without any options on oven control being touched, this feature turns oven off. Any time an option is touched, 12-hour automatic cancel is reset.

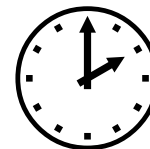

Sabbath mode

Sabbath mode overrides the normal 12-hour automatic cancel function of the oven and allows prolonged oven operation for up to 37 hours. While in Sabbath mode, oven light cannot be turned off or on. To have the oven light on during Sabbath mode, turn it on before activating Sabbath mode. All pads and sounds are deactivated in Sabbath mode. To activate Sabbath mode:

1. Press BAKE pad.
2. Enter desired oven temperature using the digit pads.
3. Press START pad.
4. Press and hold the “8” pad for approximately 3 seconds.
 - The star symbol flashes and **SAB** displays in the temperature reading.
 - After approximately 5 seconds, the star symbol will stop flashing and the temperature will again display.

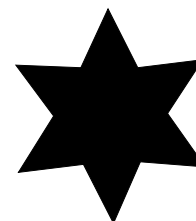

To deactivate Sabbath mode and the bake cycle press OVEN CANCEL pad. To deactivate Sabbath mode but keep the bake cycle running, press and hold the “8” pad for 3 seconds.

Sabbath mode must be reset after a power failure.

Child lockout

This safety feature is used to prevent children from accidentally programming oven by disabling electronic oven control. Child lockout is also useful to prevent accidental programming while cleaning the range control. Press and hold the “7” pad for 3 seconds. The padlock symbol displays in the control and oven emits a single beep to signify the range control is locked. To reactivate control, press and hold the “7” pad for 3 seconds on the oven control. Child lockout must be reset after a power failure.



Reminder tones

This helpful feature prompts for the next input when programming the range control. When setting a delayed bake, timed bake, or delayed self-clean the range control will emit a single beep and prompt for the next entry. If the next input is not made, display returns to time of day and programming information is lost.



Features

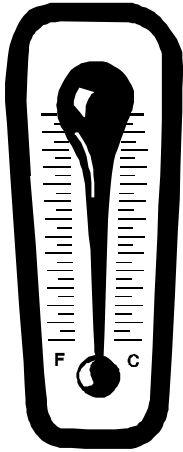

Oven temperature control adjustment

Your range is calibrated at the factory for proper temperature. Due to individual variances and preferences, it may be necessary to adjust ovens once they have been installed.

When first using the oven, follow recipe times and temperatures. Before adjusting oven baking temperature, test a recipe, such as ready-to-bake biscuits, by setting oven temperature higher or lower than the suggested temperature. The baking results should help you to decide how much of a temperature adjustment is required.

An accurate digital thermometer is necessary to calibrate the oven. Store purchased oven thermometers may not accurately measure oven temperature. Oven temperature can be increased or decreased by 35°F. To avoid over adjusting the oven, only adjust the temperature by 5°F each time.

NOTE: DO NOT place aluminum foil on racks and oven bottom as this will alter oven performance. Check for blocked heat vents. If it still appears the oven is not performing as expected, a calibration may be done.

1. Press BAKE pad.
2. Using the digit pads, enter "500".
3. Press and hold BAKE pad for approximately 3 seconds.
4. A double digit offset temperature will display. Factory default is normally 0The e degrees.
 - Press BAKE key to adjust the temperature change in 5° increments.
 - Temperature will wrap around from positive to negative numbers.
 - When temperature is adjusted to a cooler setting, a minus sign (-) will display with the offset temperature.
5. To set the temperature change, press START pad. To cancel the change, press CANCEL pad.
 - Offset temperature change will be retained through a power failure.

F-code	Possible Meaning
F0-0	No error
F1-1	Cooking temperature fault
F1-3	Cleaning temperature fault
F1-5	Cancel key input out of range
F1-7	Keyboard disconnected
F1-8	Shorted key
F1-9	Slave micro not functioning
F1-A	VCC/GNDD lift-off
F1-C	Control not calibrated
F1-E	EEPROM data corruption
F3-1	Sensor or circuit error
F9-1	Auto latch will not lock
F9-2	Auto latch will not unlock

Service codes and tones

The electronic oven control is equipped with a self-diagnostic system. The self-diagnostic system alerts you if there is an error or problem with the unit. If electronic range control sounds a series of short, rapid beeps for over 16 seconds and display shows an F-code, **record** the F-code shown. Some F-codes can be cleared by pressing cancel or disconnecting power to the range for at least 3 minutes. If the code continues to reoccur disconnect electrical supply to range and contact an authorized servicer.





Display and Signals

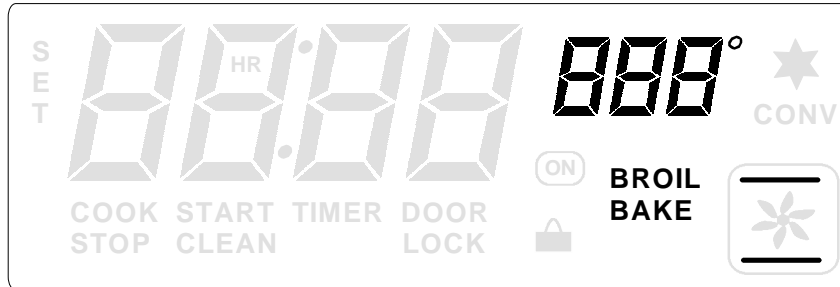

Displays time-of-day, timer and timed or delayed setting. Also displays function for oven.



Displays oven temperature and cooking method.

DISPLAY	DESCRIPTION
SET COOK TIME	Displays when cook time is being set for a timed bake.
SET STOP TIME	Displays when stop time is being set for a delayed bake or delayed self clean cycle.
SET CLEAN TIME	Displays when cycle length for a self clean cycle is being set.
SET TIMER	Displays when the timer is being set.
BROIL	Displays while oven is set to broil.
BAKE	Displays while oven is set to bake.
COOK TIME ON	Displays during an active timed cooking cycle.
	Displays when child lock is on.
	Displays while oven is in Sabbath mode.
LOCK	Displays when door is locked during the self clean cycle.
HR	Displays when setting cook time, clean time, or timer.
	Displays when oven is using broil element.
	Displays when oven is using bake element.

? There are words in the display that never actually display.

The display is used for many different models of ranges. Depending on the model, certain words or symbols may never be highlighted or become visible.

Timer Signal

When time elapses, timer beeps three, one second tones and then one beep approximately every thirty seconds until TIMER ON/OFF pad is pressed. End also displays.

Preheat Signal

After setting oven to bake and selecting a temperature, oven preheats. When oven reaches set temperature, oven signals a single audible beep.

End-of-Cycle Signal

When a timed cooking cycle is complete, the oven will beep three tones approximately one second apart, followed by one second beeps every thirty seconds until OVEN CANCEL is pressed.

Using the Oven Control

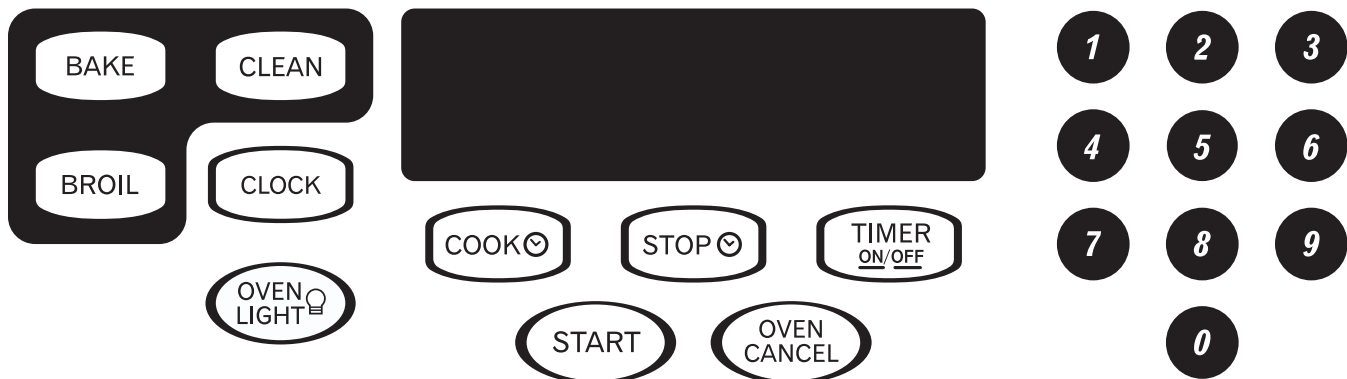

Flashing Display

When power is connected or interrupted, oven display flashes. Press CLOCK to reset display. Clock may need to be reset.

Setting Electronic Clock

12 hour clock does not display AM, PM or military time. When power is connected or restored, display flashes until CLOCK or CANCEL pad is pressed.

1. Press CLOCK pad.
2. Press digit pads (1 through 0) until correct time-of-day displays.
3. Press START pad to set time, or time is set after 5 seconds of no adjustment.



Timer Signal

When time elapses, timer will sound three one-second beeps and then once every 30 seconds. END also displays. Press TIMER ON/OFF pad to stop timer and return to clock display.

Setting Minute Timer

Timer is a timer only. Electronic timer does not control bake, broil or self-clean function. Timer can be set from 1 minute up to 11 hours and 59 minutes.

1. Press TIMER ON/OFF pad.
2. Press digit pads (1 through 0) until desired time displays.
 - Timer begins counting down automatically after time is entered.
 - To view clock while timer counts down, press CLOCK pad. Timer will return after approximately 3 seconds of no input.
3. Press and hold TIMER ON/OFF pad to cancel timer signal.
 - After time elapses, timer beeps three one-second tones, and then once approximately every 30 seconds until CANCEL is pressed. END is also displayed when the timer finishes.



Resetting and Canceling Timer

To reset the time when remaining time is displayed, press TIMER ON/OFF pad, then use the digit pads to enter the new time. To cancel timer when remaining time is displayed or when signal is beeping, press and hold TIMER ON/OFF pad for approximately 3 seconds or press CANCEL pad. CANCEL will stop all cooking functions if the oven is in use.

Using the Oven Control (cont'd)

Baking

While oven is still cool, remove any stored items from the oven cavity.

1. Place racks in desired position and close oven door.
2. Press **BAKE** pad.
 - **SET** and **BAKE** flash in display.
 - Temperature default of 350° displays.
3. Use digit pads (1 through 0) to enter desired oven temperature if it is different than 350°F.
 - Temperature range is 170°F to 550°F.
4. Press **START** pad.
 - Bake mode starts automatically
 - **BAKE, ON** and bake element graphic display.
 - Current oven temperature is displayed during baking cycle.
5. Oven emits a single beep when it has reached baking temperature.
6. Open door carefully and place food in oven.
7. After cooking time elapses, remove food and press **OVEN CANCEL** pad to shut off oven.



WARNING

To avoid risk of personal injury, property damage or fire, do not line oven bottom, racks, or broiler pan and grid with aluminum foil.



WARNING

To avoid risk of personal injury, property damage or fire, never leave oven unattended while broiling.

Preheat Signal

After setting oven to bake and selecting a temperature, oven preheats. When oven reaches set temperature, the preheat signal sounds.

Broiling

Broiling sears in natural juices and provides charbroiled flavor.

To broil, center food on broiling grid and pan and place on proper rack in oven. Do not place aluminum foil over broiling pan, oven rack or oven bottom. **Oven door must be fully closed.** Broiling does not require preheating so you can place food in oven while it is still cool.

1. Adjust oven racks to desired position.
2. Place food on desired rack.
3. Close oven door.
4. Press **BROIL** pad.
 - **SET** and **BROIL** flash in display.
 - Broil temperature setting defaults to HI.
 - To change broil setting, use digits 1 (LO) to 5 (HI).
5. Press **START** pad.
 - Broil begins automatically.
 - **BROIL, ON** and broil element graphic display.
6. **Keep oven door closed.**
 - If oven door is ajar for more than 3 minutes, broil cycle will stop.
 - If broil cycle stops because the door was open too long, close oven door and broil cycle will continue.
7. After broiling, remove food and press **OVEN CANCEL** to turn off broiler.
8. To end broil in mid-cycle press **OVEN CANCEL** pad.



How Do I Change the Temperature?

While the oven is baking, simply press **BAKE**, enter the desired temperature, and then press **START**. Use these steps to change the oven temperature during Timed and Delayed Baking, also. To change cook time during Timed or Delayed Baking, press **COOK TIME**, enter the desired cooking time, and press **START**.

Why is the oven smoking?

With new ovens, some minor smoking is normal when using the oven for first few times. Performing a self-clean cycle should stop further smoking.

Using the Oven Control (cont'd)

What's the difference between TIMED and DELAYED cooking?

When using TIMED cooking, the oven begins to heat immediately after the oven control is set. Then, the oven cooks for the desired length of time set. When using DELAYED cooking, the oven begins to cook later in the day. Set the time that you want to stop cooking and how long you want to cook. The oven calculates the time to begin cooking and cooks for the specified length of time.

How Far Ahead Can I Set the Time?

Cook time and end time can be set up to 11 hours and 59 minutes ahead. When cooking time has elapsed, an end of cycle signal sounds, oven automatically turns off and END displays. Oven signal sounds 4 times, then once every 10 seconds until OVEN CANCEL is pressed. Broil can not be set to Timed or Delayed.

How much time is left?

For a delayed bake cycle, the stop time displays continuously during the delayed bake cycle. For a timed cooking cycle, the amount of time remaining displays continuously. Clock (time of day) cannot be viewed when using timed baking or a delayed baking cycle.



CAUTION

To avoid the risk of food poisoning due to bacterial growth and production of toxins, never hold meat, milk, fish, or eggs for more than 2 hours before cooking.

Timed Baking

Set oven to cook for desired amount of time. Follow recipe directions for preheating the oven.

1. Place racks in desired position, place food in oven, and close oven door.
2. Press COOK TIME pad.
3. Use the digit pads (1 through 0) to enter the desired cook time.
 - Cook time can be set up to 11 hours and 59 minutes.
4. Press BAKE pad.
 - Default temperature is 350°F.
 - Bake temperature can be set from 170°F to 550°F.
 - Use the digit pads to enter desired bake temperature.
5. Press START pad.
 - Oven will automatically begin to heat.
 - Current oven temperature displays.
 - To adjust cook time, press COOK TIME pad while the remaining cook time is displayed. Cook time can then be adjusted.
 - When cooking time has elapsed an end of cycle signal sounds. Oven signal sounds 3 times, then once every 30 seconds until OVEN CANCEL pad is pressed. END also displays.
6. Press OVEN CANCEL pad to cancel baking.



Delayed Baking

Set oven to begin and end baking at a later time. Oven control automatically calculates starting time.

1. Place food in oven.
2. Press STOP TIME button.
 - Default time displayed is current time of day.
3. Use the digit pads (1 through 0) to enter the desired stop time.
 - Stop time can be set up to 11 hours and 59 minutes ahead of current time of day.
4. Press COOK TIME pad.
 - Cook time can be set up to 11 hours and 59 minutes.
 - 1 minute minimum cooking time.
 - Electronic control automatically calculates start time.
6. Press BAKE pad.
 - Bake temperature can be set from 170°F to 550°F.
 - Use the digit pads to enter desired bake temperature.
7. Press START pad.
 - Oven will automatically begin to heat at calculated start time.
 - **ON** displays when oven begins to heat.
 - To adjust cook time, press COOK TIME pad while the remaining cook time is displayed. Cook time can then be adjusted.
 - When cooking time has elapsed an end of cycle signal sounds. Oven signal sounds 3 times, then once every 30 seconds until OVEN CANCEL pad is pressed. END also displays.
6. Press OVEN CANCEL to cancel baking.



Using the Oven Control (cont'd)

Self-cleaning

Self-clean feature uses high oven temperature to clean oven interior. For the oven to operate through a complete self-clean cycle, the self-clean must be set when the oven is cool.

1. Prepare oven for self-cleaning (see below right).
2. Close door.
3. Press CLEAN pad.
 - **SET CLEAN TIME** flashes in display.
 - The default self-clean cycle length of 3 hours displays.
 - Adjust clean cycle length by using digit pads (1 through 0).
 - Clean cycle can be set from two to four hours in one minute increments.
4. Press START pad.
 - **CLEAN, TIME, LOCK, ON** and both bake and broil element graphics display.
 - Surface burners should not be used until completion of self-clean cycle.
 - At the end of self-clean cycle, **END** displays. No signal tone will sound.
 - **ON** no longer displays. Oven will shut off.
 - **LOCK** will remain on until oven reaches a cooler temperature.
 - **LOCK** will shut off when door has unlocked. Oven cavity will be hot to the touch. **DO NOT** attempt to open door prior to LOCK shutting off.

CLEAN

START

Interrupting the self-clean cycle

To stop a self-clean cycle that has already started follow these steps. If the interruption occurs mid cycle, the oven will remain locked, even though the cycle has stopped, until the oven cavity has cooled to a lower temperature.

1. Press OVEN CANCEL.
2. When oven has cooled to a lower temperature, LOCK light turns off. Door can be opened. **DO NOT** force door. This can cause damage to the latch.



CAUTION

- To avoid fire or smoke damage,
- remove any flammable materials from storage drawer. Items like plastic containers and paper manuals can melt or burn.
 - clean excess spills before starting a self-clean cycle.



WARNING

- To avoid risk of personal injury, do not touch range top, door, oven vents, or area around vents, during self-cleaning. These areas can become hot enough to cause burns.

Do I need to prepare?

To get the best results from the self-clean cycle, follow these steps:

- Clean excess spills from oven interior and bottom.
- **Remove birds or animals susceptible to smoke or other fumes from the room or adjoining room.**
- Open window if possible.
- Make sure oven light cover is properly in place. Do not use cleaning cycle if it is not.
- Remove oven racks, pans and all cooking utensils from oven.
- Remove items from range top, storage drawer, and backguard. These areas can become hot during self-cleaning cycle.
- The range vents from the center bottom of the backguard. Make sure this area is unobstructed by removing all items from backguard and range top.

Using the Oven Control (cont'd)



WARNING

To avoid risk of personal injury, do not touch range top, oven door, oven vents, or area around vents, during self-cleaning. These areas can become hot enough to cause burns.



CAUTION

To avoid fire or smoke damage,

- remove any flammable materials from storage drawer. Items like plastic containers and paper manuals can melt or burn.
- clean excess spills before starting a self-clean cycle.

Do I need to prepare?

To get the best results from the self-clean cycle, follow these steps:

- Clean excess spills from oven interior and bottom.
- **Remove birds or animals susceptible to smoke or other fumes from the room or adjoining room.**
- Open window if possible.
- Make sure oven light cover is properly in place. Do not use cleaning cycle if it is not.
- Remove oven racks, pans and all cooking utensils from oven.
- Remove items from range top, storage drawer and backguard. These areas can become hot during self-cleaning cycle.
- The range vents from the center bottom of the backguard. Make sure this area is unobstructed by removing all items from backguard and range top.

Delayed Self-clean Cycle

Self-clean feature uses high oven temperature to clean oven interior. Set oven to begin and end cleaning at later time. Oven control calculates start time automatically.

1. Prepare oven for self-cleaning (see below left).
2. Close door.
3. Press CLEAN pad.
 - **SET CLEAN TIME** flashes in display.
 - The default self-clean cycle length of 3 hours will display.
 - Adjust clean cycle length by using digit pads (1 through 0).
 - Clean cycle can be set from two to four hours in one minute increments.
4. Press STOP pad.
5. Set stop time for the cleaning cycle.
 - Default time is current time of day plus selected clean cycle length.
 - Stop time can be set from current time to current time plus 11 hours and 59 minutes.
6. Press the START pad.
 - Self-clean cycle is set.
 - **STOP, CLEAN** and **TIME** display while oven is in delay mode.
 - Oven cannot be used until completion of the self-clean cycle.
 - Clock (time of day) cannot be viewed when using a delayed self-clean cycle
 - **CLEAN, TIME, LOCK, ON** and both bake and broil element graphics display when self-clean cycle begins.
 - Clean time displays during self-clean cycle..
 - At the end of the self-clean cycle, **END** displays. No signal sounds at end of cycle.
 - **ON** no longer displays and oven shuts off.
 - **LOCK** will remain on until oven reaches a cooler temperature. **LOCK** will flash while door is unlocking, and then shut off when door has unlocked. Oven cavity will be hot to the touch. **DO NOT** attempt to open door prior to LOCK shutting off.



Interrupting the self-clean cycle

To stop a self-clean cycle that has already started follow these steps. If the interruption occurs mid cycle, the oven will remain locked, even though the cycle has stopped, until the oven cavity has cooled to a safe temperature.

1. Press OVEN CANCEL.
2. When oven has cooled to a lower temperature, LOCKED light shuts off. Door can be unlocked. **DO NOT** force door. This can cause damage to the latch.

Baking Guidelines

When baking with a new oven, keep in mind temperatures vary from oven to oven. Store-bought thermometers are generally not accurate and should not be used to calibrate oven temperatures.

Hints for Cookies,

- Shiny, flat cookie sheets should be used. Avoid cookie pans with high sides—this will cause uneven browning on the top.
- **Cookie sheet should not touch the sides of the oven or door.**

Cakes,

- Follow recipe's directions for pan size. Shiny pans work best for cakes.
- Cake baked in too large a pan will be thin and dry. Too small a pan will be undercooked or unevenly cooked and may spill.

Pies

- Pies should be baked in dark or dull pans to increase browning.
- Frozen pies should be heated on an aluminum cookie sheet.

BAKING TIME GUIDELINES

Cake Pan Type	Pan size	Cups of batter	Oven Temp.	Minutes
Oval	7 ¾" x 5 ¾"	2 ½	350°F	25 to 30
	13" x 9 ¾"	8	350°F	25 to 30
Round, 2" layer	6"	2	350°F	25 to 30
	8 "	3	350°F	30 to 35
	14"	10	350°F	50 to 55
Round, 3" layer	8"	5	325°F	60 to 65
	12"	11	325°F	75 to 80
Half Round, 2" layer	18"	9	325°F	60 to 65
Half Round, 3" layer	18"	12	325°F	60 to 65
Square	6"	2	350°F	25 to 30
	10"	6	350°F	35 to 40
	16"	15 1/2	350°F	45 to 50

BAKEWARE GUIDELINES

Dark or dull pans	Absorb more heat and result in darker browning. Recommended for pies and breads.
Shiny pans (no sides)	Recommended for cookies.
Shiny pans (sides)	Recommended for cakes
Glass pans	Lower recommended oven temperature by 25°F.

Bake Pan Placement

- Keep pans and baking sheets 2 inches from oven walls.
- Stagger pans placed on different racks so one is not directly over the other.

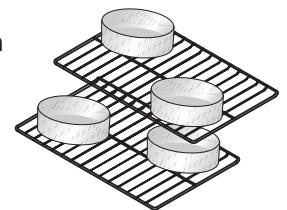

Preheating

In most cases, you should preheat the oven before baking. After the range control is set, the oven temperature will begin to rise until the desired cooking temperature is reached (approximately 8 to 10 minutes). When cooking temperature is reached oven signal beeps. **For delicate baking (such as puff pastries or souffles), preheat approximately 15–20 minutes before placing food inside oven or wait 10 minutes after oven signal beeps before placing food in oven.** The extra time creates a more stable oven temperature.

Cooking (cont'd)

Common Baking Problems

If you begin to notice consistent problems refer to the chart below for possible solutions. If results are still poor, contact **Amana Consumer Affairs at (800) 843-0304**.

Test your cakes for doneness

while they are still in the oven. Because of variances across individual ovens, it is best to test for the proper consistency rather than solely relying on time and visual appearance as an indicator.

It may not be the oven

Cake problems may be in the mixing of the batter. Overbeating can cause cake structure to break down and excessive shrinkage of the cake. Underbeating can result in lumpy cakes that may not be cooked thoroughly. **All ingredients should be at room temperature—not out of the refrigerator.** Make sure to follow the recipes directions for how long the batter should be mixed.

Cake stuck?

Allow cake to cool in cake pan on a rack for 10 minutes before removing. Larger cakes (over 14 inches in diameter) may take 15 minutes. If the cake has cooled too long, reheat in the oven at 250°F for a few minutes.

Better with butter

Make sure to follow recipe directions and use butter or margarine when it is listed. Using a low fat substitute will cause a recipe to fail.

Problem	Cause
Lopsided cakes (bake unevenly)	Pans touching each other or oven walls. Batter spread unevenly in pan. Uneven heat distribution in oven. Oven is not level.
Cakes, cookies, biscuits too brown on bottom or top	Oven not preheated. Pans touching each other or oven walls. Using glass, darkened, warped or dull finish metal pans. Rack position too high or low. Incorrect use of aluminum foil. Oven temperature too high.
Pies don't brown	Incorrect rack position. Using shiny metal pans. Temperature set too low.
Cakes not done in center	Temperature too high. Pan too small. Baking time too short. Pan not centered in oven.
Cakes fall	Too much shortening or sugar. Too much or too little liquid. Temperature too low. Old or too little baking powder. Pan too small. Oven door opened frequently (peeking). Insufficient baking.
Excessive shrinkage	Too little leavening. Mixing batter too long. Pan too large. Oven temperature too high. Baking time too long.
Cakes high in middle or cracked	Temperature set too high. Overmixing. Too much flour. Pans touching each other or oven walls.

Meat Basics

While cooking has always been a talent, it is now becoming a science, also. Amana provides this information as a guide to aid in preparation. For specific questions regarding meat preparation, handling, or storage contact **USDA (United States Department of Agriculture) Meat & Poultry Hotline at (800) 535-4555.**

Handling Hints

- When shopping, put meat in its own separate plastic sack to keep drips off other foods.
- Defrost frozen meats in refrigerator, not at room temperature.
- Keep meat cool and covered until it is time to cook.
- Wash hands with warm soapy water before and after handling meat or raw egg.
- Thoroughly wash any surface or utensil raw meat or egg touched.
- Do not put cooked meat on the same plate that held raw meat.

Cooking Tips

- Marinate meat in the refrigerator. Throw out excess marinade that came into contact with meat.
- Use an oven-proof meat thermometer.
- Cook meat to internal temperature recommended by USDA.
- When reheating foods, heat to an internal temperature of at least 165 °F.
- While cooking meats, turn over at least once.

Storage Safety

- Once carved, refrigerate unused portion immediately.
- Keep hot foods hot and cold foods cold when serving meals.
- Separate cooked foods into small portions for fast cooling.
- Do not store cooked ground meats or meals containing ground meats for longer than 3 to 4 days in the refrigerator.
- Do not allow cooked or uncooked meat juices to come into contact with ready-to-eat foods such as fruits or vegetables.

Tenderizing

Braising is only one way to tenderize less tender cuts. Before cooking, you may pound, cube, marinate, or use commercially prepared meat tenderizers. You may then use a dry method to cook the meat.

- **Marinades** are acidic liquids such as wine, citrus, or vinegar. Marinades soften meat fibers but only penetrate about one-fourth of an inch into the interior of the meat. Do not marinate meat for longer than 24 hours.
- **Pounding** with a heavy meat mallet breaks down the connective tissue to tenderize meat.
- **Cubing** breaks down the structure more than pounding. Cubing is done at the meat counter.
- **Commercial tenderizers** are primarily enzymes that work on the outer fourth inch on a meat cut. Make sure to follow the manufacturer's directions.

Using a Meat Thermometer

When using a meat thermometer, remember to insert it at a slight angle, in the thickest part of the meat, away from fat and bone. The meat should be removed when 5°F below the desired final temperature. While the meat sits before carving, it will continue to cook internally, raising the last 5°F by itself.

A meat thermometer can

- Take the guesswork out of cooking to a desired 'doneness'.
- Help reduce the risk of foodborne illness.

Oven-safe Thermometer

- Inserted before the meat is placed in the oven, this thermometer stays with the meat while it cooks.
- The internal temperature will rise slowly as the meat cooks.

Instant-read Thermometer

- Not oven safe, these thermometers are placed in the meat when it is removed from the oven.
- While times may vary, an accurate temperature is normally displayed within one to two minutes.
- When using an instant-read, remember to clean the thermometer stem with warm, soapy water between readings.

Cooking (cont'd)

Broiling Guidelines

Broiling is a dry heat cooking method that allows a restaurant quality charbroiled flavor. Meat is exposed directly to the heating element at high temperatures.

1. Place meat on rack in broiler pan, with the surface of cuts the specified distance from the heating element (specified below).
2. Broil for half the recommended time, or until the surface is browned.
3. Turn meat and continue broiling to desired internal temperature.
4. Season, if desired.
5. Oven door must be fully closed.

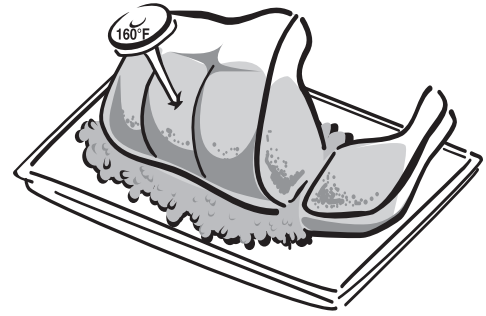

Meat Cut	Recommended Internal Temperature	Thickness (inches)	Weight (pounds)	Distance From Heat (inches)	Approximate Cooking Time (minutes)	
BEEF						
Chuck Shoulder Steak	Very Rare 130°F Rare 140°F Medium Rare 145°F Medium 160°F Well Done 170°F Very Well Done 180°F	¼ 1	¼ to 1 1 to 1 ¼	2 to 3 3 to 4	12 to 14 8 to 12	
Rib Eye Steak		¾ 1 1 ½	½ ½ to ¾ ¾ to 1	2 to 3 3 to 4 4 to 5	8 to 12 10 to 15 20 to 25	
Sirloin Steak		¾ 1 1 ½	1 to 1 ¾ 1 ½ to 3 2 ¼ to 4	2 to 3 3 to 4 4 to 5	10 to 15 16 to 21 21 to 25	
Porterhouse Steak		¾ 1 1 ½	¾ to 1 1 ½ to 2 2 to 3	2 to 3 3 to 4 4 to 5	8 to 12 10 to 15 20 to 25	
Filet Mignon (Tenderloin)		—	¼ to ½	2 to 4	10 to 15	
Flank Steak		—	1 to 1 ½	2 to 3	12 to 14	
Ground Beef Patties		160°F minimum	¾ to 1	1	3 to 4	10 to 15

PORK					
Chops, bone in	All pork must be cooked to an internal temperature of at least 160°F to reduce the likelihood of Trichinosis. Failing to cook the meat to this temperature could result in personal injury or illness.	¾	—	4	6 to 8
Chops, boneless		¾	—	4	6 to 8
Tenderloin		—	½ to 1	4	15 to 25
Kabobs		1 inch cubes	—	4	10 to 20
Lean Ground Pork Patties		½	—	4	8 to 10

LAMB					
Loin Chops	Medium 160°F Well Done 170°F	1	—	3 to 4	10 to 15
Rib Chops		1	—	3 to 4	10 to 15
Sirloin Steaks		1	—	3 to 4	12 to 15
Top Round Steaks		1	—	3 to 4	12 to 15
Center Leg Steaks		1	—	3 to 4	15 to 20
Cubes for Kabobs		1 ¼ pieces	—	3 to 4	10 to 15
Lamb Patties		½ x 4 inches	¼ each	3 to 4	12

All times and recommended temperatures are provided by the USDA, the Beef Industry Council, the National Pork Producer's Council, and the American Sheep Industry Council.

Roasting Guidelines

Tender cuts such as rib and loin cuts are best cooked by dry heat methods, such as roasting. To roast:

1. Heat oven to desired temperature.
2. Place roast directly from refrigerator fat side up in a shallow roasting pan.
3. Insert ovenproof meat thermometer so tip is centered in thickest part of roast. Make sure thermometer does not rest in fat or on bone.
4. Remove roast 5°F below desired degree of finished internal temperature.
5. Transfer roast to carving board and tent loosely with aluminum foil for approximately 15 minutes.

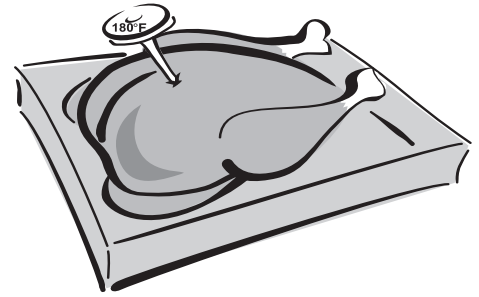

Meat Cut	Recommended Internal Temperature	Oven Temperature	Weight (pounds)	Approximate Cooking Time (minutes)
----------	----------------------------------	------------------	-----------------	------------------------------------

BEEF

Boneless Rump Roast		325°F	4 to 6	25 to 30
Tip Roast	Very Rare 130°F	325°F	3 ½ to 4	30 to 40
Eye Round Roast	Rare 140°F	325°F	4 to 6	20 to 30
Tenderloin Roast	Medium Rare 145°F	425°F	2 to 3 4 to 6	35 to 45 45 to 60
Rib Roast	Well Done 170°F	325°F	4 to 6 6 to 8	26 to 42 23 to 35
Rib Eye Roast	Very Well Done 180°F	350°F	4 to 6	18 to 24

PORK

Loin Roast, bone-in	All pork must be cooked to an internal temperature of at least 160°F to reduce the likelihood of Trichinosis and other food-borne illnesses.	350°F	3 to 5	20 minutes per pound
Rib Roast, boneless		350°F	2 to 4	
Tenderloin		450°F	½ to 1	
Ham bone-in, cook-before-eating		325°F	7 to 8	

LAMB

Shoulder		325°F	3 ½ to 6	35 to 40
Rib Roast		375°F	1 ½ – 2 ½	30 to 35
Rib Crown Roast, not stuffed	Medium-Rare 150°F	375°F	2 to 3	25 to 30
Loin Roast	Medium 160°F	325°F	1 ¼ to 1 ¾	45 to 55
Leg, Frenched Style or Half Shank	Well Done 170°F	325°F	5 to 7 7 to 9	15 to 20 20 to 25

POULTRY (unstuffed)

Capon	To reduce the risk of food-borne illnesses, poultry must be cooked to an internal temperature of 180°F.	325 to 350°F	4 to 8	20 to 30 min/lb.
Cornish Hens, whole		325 to 350°F	1 ¼ to 1 ½	50 to 60 total
Duck, whole		325 to 350°F	—	18-20 min/lb.
Goose, whole		325 to 350°F	—	20 to 25 min/lb.
Pheasant, whole		325 to 350°F	2	30 min/lb.
Quail, whole		325 to 350°F	—	20 minutes total
Turkey		325°F	8 to 16	3 ½ to 5 ½ hours

All times and recommended temperatures are provided by the USDA, the Beef Industry Council, the National Pork Producer's Council, and the American Sheep Industry Council.

Cooking (cont'd)

Braising Guidelines

Less tender cuts such as those from the round, chuck, brisket and shank require moist cooking. A longer cooking time at lower temperatures with moisture helps soften the meat.

1. Brown meat with a small amount of oil in heavy pan.
2. Pour off excessive drippings, season, if desired.
3. Add small amount of liquid (1/2 to 2 cups) and cover tightly.
 - Simmer gently over low heat on top of the range or in a 325°F oven, until meat is fork tender.

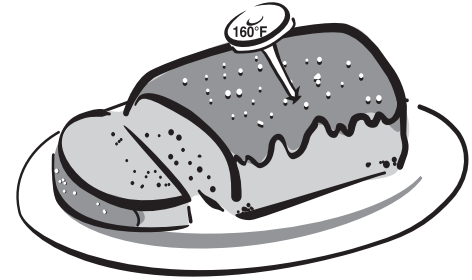

Meat Cut	Recommended Internal Temperature	Oven Temperature	Weight (pounds) OR Thickness	Approximate Cooking Time (hours)
BEEF				
Blade Pot Roast	Meat should be cooked to a temperature of at least 160°F to reduce the likelihood of food-borne illnesses.	325°F	3 to 5	1 ½ to 2
Arm Pot Roast		325°F	3 to 5	2 to 3
Chuck Roast (boneless)		325°F	3 to 5	2 to 3
Short Ribs		325°F	2 inches x 2 inches x 4 inches thick	1 ½ to 2 ½
Round Steak		325°F	¾ to 1 inch thick	1 to 1 ½
Flank Steak		325°F	1 ½ to 2 inches thick	1 ½ to 2 ½
LAMB				
Shoulder Chops, Round Bone or Blade	Meat should be cooked to a temperature of at least 160°F to reduce the likelihood of food-borne illnesses.	325°F	1 inch thick	1 to 1 ¼
Riblets		325°F	3 pounds	1 ½ to 2
Shanks		325°F	3 pounds	1 to 1 ½
Stew Cubes		325°F	1 inch pieces 1 ¼ lbs.	1 ¼ to 1 ½

All times and recommended temperatures are provided by the USDA, the Beef Industry Council, the National Pork Producer's Council, and the American Sheep Industry Council.

Care and Cleaning



CAUTION

To avoid personal injury or property damage, handle oven door with care.

- Do not lift door by handle.
- Remove storage drawer.
- Door is heavy and can be damaged if dropped.
- Screwdriver can scrape or chip range or oven finish.
- Do not scratch or chip glass or twist door. Glass may break

Cleaning Oven Door

Not all areas of the oven are cleaned by the self-clean cycle. The oven door, the gasket and area surrounding the gasket will not be cleaned effectively by the self-clean cycle. **DO NOT** use spray cleaners to clean the outside or inside of the oven door.

DO NOT clean the gasket. Do not wet, rub, soak or use any type of cleaning material to clean the oven gasket. Any damage or defects occurring from attempting to clean or remove the gasket are not covered by warranty.

To clean the area around the gasket make sure oven is cool to the touch. Using a cloth with a mild soap wipe area needing to be cleaned. Avoid gasket. Gasket should not be removed while cleaning. Do not allow water or cleaning solution to spill or drip onto gasket.

Removing Storage Drawer

1. Slide drawer out until it stops.
2. Remove stored items.
3. Grasp drawer sides near back of drawer.
4. Lift up and out. Reverse to reinstall.

Removing Oven Door

1. Fully open oven door.
2. Push hinge locks down toward door frame, to the unlocked position.
 - This may require a flatblade screwdriver.
3. Firmly grasp both sides of top of oven door.
4. Close door to first stop position.
5. Lift door up until hinge arm is clear of the slot.

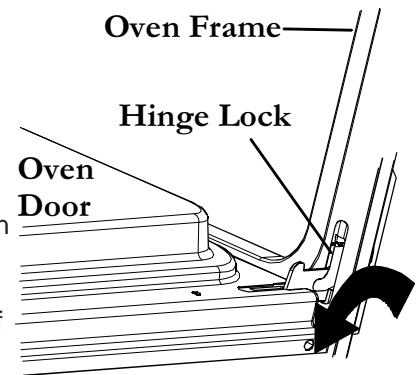

Replacing Oven Door

1. Grasping door top firmly, seat indentation of hinge arm into bottom edge of the hinge slot.
 - Door should be at the first stop position angle.
2. Fully open oven door.
3. Push hinge locks up against the front frame of the oven cavity to locked position.
4. Close oven door.

Door Gasket

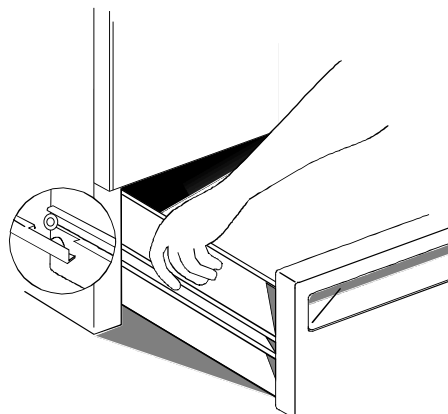
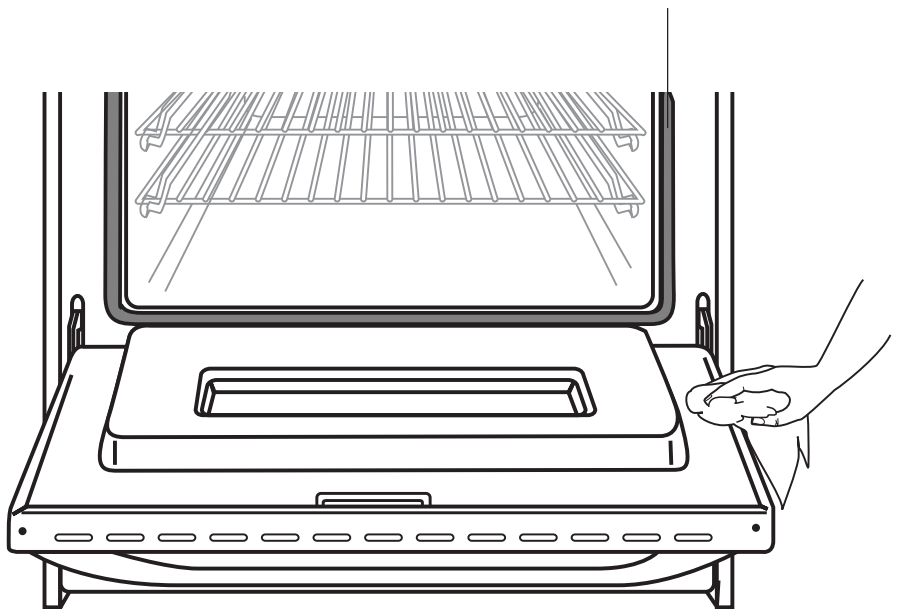

Care and Cleaning (cont'd)

WARNING

To avoid risk of burns or electrical shock:

- disconnect electrical supply to oven before changing light bulb.
- before replacing light bulb make sure oven and bulb are cool.
- Do not operate oven without bulb and cover in place.

CAUTION





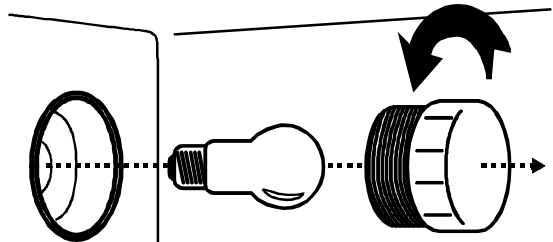

To avoid risk of personal injury, Wear gloves to protect hands from accidental bulb breakage.

Replacing Oven Light

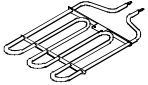
1. Disconnect electrical supply.
2. Remove oven door if desired.
3. While wearing protective gloves, unscrew counter clockwise the light bulb cover located in rear of oven cavity. Then turn light bulb counterclockwise to remove.
4. Replace light bulb with 120-volt, 40-watt appliance bulb. **Do not over tighten bulb or cover or they may be difficult to remove later.**
5. Replace light bulb cover and oven door before use.
6. Reconnect power supply.

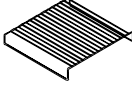

To keep your smoothtop looking like new, Amana recommends routine cleaning. The following general instructions for routine and tough spot cleaning are based on the performance of Amana recommended products. To order these products, contact the Consumer Affairs department at **800-843-0304**.

PART	GENERAL DIRECTIONS
Broil element 	Do not clean broil element. Any soil will burn off when element is heated.
Broiler pan and grid 	Drain fat, cool pan and grid slightly. (Do not stand soiled pan and grid in oven to cool.) Sprinkle with soap. Fill the pan with warm water. Let pan and grid stand for a few minutes
Control knobs 	Pull off knobs. Wash gently with mild soap and water but do not soak. Dry and return knobs to oven, making sure to match flat area on the knob to the flat area on the shaft.
Outside finish 	Wash all glass with cloth dampened in soapy water. Rinse and polish with a dry cloth. If knobs are removed, do not allow water to run down inside surface while cleaning.
Oven racks 	For heavy soil, place oven racks in large plastic bag with ammonia and water in cup. Seal tightly and allow to stand overnight. Wash and rinse, dry thoroughly.
Storage drawer 	For heavy soil, clean by hand and rinse thoroughly. Remove drawer for ease in cleaning. Be sure drawer is dry before replacing.

Care and Cleaning (cont'd)

Caring for the smoothtop

For routine cleaning, allow top to cool before cleansing. Wash surface with a dampened cloth and smoothtop cleaner conditioner. Use another clean damp paper towel to wipe off the cleaner. Use a dry paper towel, buff the smoothtop to make sure all the cleaner conditioner is removed. The smoothtop cleaner conditioner provides a thin layer of protective polish that helps to prevent scratching. Do not use a harsh cleanser or steel wool pad. For specific problems, see below.

PROBLEM	CAUSE	REMOVAL
Brown streaks and specks	Cleaning with sponge or cloth containing soiled detergent water	Normal cleansing (provided above)
Blackened, burnt on spots	Spatters or spillovers on a hot cooking area or accidental melting of plastic like a bread bag	Clean area with smoothtop cleaner conditioner with clean damp paper towel, nonabrasive nylon pad, or scouring brush. If spot is not removed, on cool cooktop carefully scrape area with a safety scraper held at a 30-degree angle.
Fine brown gray lines, fine scratches or abrasions	Course particles, like salt, become embedded in top if trapped under pan. Using abrasive cleaning materials. Scratches from rough ceramic, glass, or ceramic coated cookware.	Fine scratches are not removable but can be minimized by daily use of smoothtop cleaner conditioner.
Smearing or streaking	Using too much smoothtop cleaner conditioner or using a soiled dish cloth.	Follow label instructions carefully. See Routine Cleaning, above.
Metal or silver/gray marks	Sliding or scraping metal utensils across top.	Remove marks before top is used again. If marks are not removed by normal cleaning, use a safety scraper at a 30° angle and cooktop cleaner conditioner to carefully scrape off the mark.
Pitting or flaking	Boilovers of sugar syrup on a hot smoothtop can cause pitting if not removed immediately.	Turn control to LOW setting. Wipe up excess spill with dry cloth. Allow top to cool and carefully scrape area with a safety scraper held at a 30-degree angle.
Hard water spots	Condensation from cooking can cause minerals found in water and acids in food to drip onto smoothtop and cause gray deposits. Spots are often so thin they appear to be in or under smoothtop.	Mix smoothtop cleaner conditioner with water and apply thick paste to stained area. Scrub vigorously. If stain is not removed, reapply cleaner and repeat process OR make sure the surface is cool and put a small amount of white vinegar on the spot and let it sit a few minutes. Using a nonabrasive nylon pad, gently rub the spot. Wipe off any excess with a damp paper towel, then dry.

Care and Cleaning (cont'd)



Cleaning Stainless Steel

Damage to stainless steel finish due to improper use of cleaning products, or using non-recommended cleaning products, is not covered under warranty. For Amana recommended products, call Consumer Affairs at **1(800) 843-0304** or online at www.amana.com.

Our stainless steel appliances have been factory finished for high shine and luster. To maintain this quality appearance:

DO NOT USE:

- Abrasive powders or liquids
- Citrus based cleaners
- Ammonia
- Steel wool pads
- Abrasive cloths
- Oven cleansers
- Acidic or vinegar based cleaners

DO USE:

- Warm soapy water for routine cleaning
- Soft clean cloths to dry or polish
- Stainless steel cleaner designed for appliances such as **Amana Cleaning Polish and Conditioner for Stainless Steel (#31960801)**



Can I use liquid cleaners on my stainless steel?

Just because a cleaner is a liquid does not mean it is non-abrasive. Many liquid cleansers designed to be gentle on tile and smooth surfaces still damage stainless steel. Cosmetic damage from using non-recommended products is not covered under warranty.



Citric Acid

Citric acid permanently discolors stainless steel. To prevent damage to the finish of your stainless steel appliance, do not allow these substances to remain on the steel finish:

- mustard
- tomato juice
- marinara sauce
- citrus based sauces
- citrus based products



For best cleaning results

1. Wash surfaces with warm soapy water and a soft, clean cloth or sponge.
2. Rinse surfaces with warm water. Dry surfaces with a soft, clean cloth.
DO NOT use the following harsh cleaners:
 - abrasive or acidic cleaners (ammonia, chlorine bleach, vinegar-based product, etc.)
 - citrus-based cleaners
 - scouring pads (metal, textured plastic, etc.)These items can scratch, discolor, or permanently tarnish surfaces.
3. Follow up rinsing by immediately drying with a soft, clean cloth. This will avoid water spotting on stainless steel finish.



Questions? Comments?

Concerns? Contact us!

www.amana.com

or call Consumer Affairs at

1-800-843-0304

Troubleshooting

You may save time and money by checking items below before calling for service. List includes common concerns that are not the result of defective workmanship or materials. If your question is not explained below, contact Amana Consumer Affairs Department at **800-843-0304**.

Topic	Possible Cause	Solution
-------	----------------	----------

OPERATION

Appliance not working	Power outage	Make sure appliance is plugged in. Verify that circuit breaker is not tripped. Replace household fuse but do not change fuse capacity.
Frequent cycling of surface element or warming zone	Normal	Element cycles to maintain proper heat and to prevent damage to smoothtop.
Oven not working	Programming error	Shut off power to oven for five minutes by switching off circuit breaker. Reset circuit breaker and try oven again.
Clock and timer not working	Power outage	Make sure appliance is plugged in. Verify that circuit breaker is not tripped. Replace household fuse but do not change fuse capacity.
Oven light not working	Loose bulb Burnt out bulb	Check for loose bulb. Tighten. Check for burnt out bulb. Replace if necessary with an appliance bulb.
Self Clean not working	Programming error	Shut off power to oven for five minutes by switching off circuit breaker. Reset circuit breaker and try oven again.
Oven door will not unlock	Oven is self-cleaning Oven still hot	Allow cycle to complete. Will not unlatch until a cooler temperature has been reached. Do not force door open—will void warranty. May blow cooler air on latch area with hair dryer at cool setting to quicken process.
Oven not clean after a self clean cycle	Too much soil, grime left in oven Soot remains in oven after cycle	Wipe out and remove excess soil prior to running self-clean cycle. Normal.
Locked light displayed	Door locked	If oven is hot, allow to cool rather than trying to force door latch open.
Display flashing	Power failure reset clock	Press CLOCK.
F-(numeric) display	Service code	Shut off power to oven for one to two minutes by switching off circuit breaker. Reset breaker. If continues, contact service department.
Oven smokes the first few times used	Normal	Minor smoking is normal the first few times the oven is used.

COOKING

Food not baking properly	Various causes	See Cooking, Common Baking Problems
Food not roasting properly	Various causes	See Cooking, Roasting
Food not broiling properly	Various causes	See Cooking, Broiling
Oven temperature too hot or cold	Calibrate oven temperature	See Using the Oven Control, Oven Temperature Control Adjustment
Oven has strong odor	Normal	Ovens will have a 'new' odor. Run a self-clean cycle to remove the odor.
Not boiling or cooking fast enough	Improperly sized cooking utensils	Make sure pans fit heating elements. See Cookware Requirements .

Troubleshooting (cont'd)

NOISE

Frequent cycling off and on of oven.	Normal	To maintain a temperature for baking, the oven cycles on and off.
Cracking or popping sound	Normal	Wet cooking utensils or possible spillage. Expansion and contraction of metal components.

APPEARANCE

Scratches	Gritty dirt or rough surface on cooking utensils	Use recommended smoothtop cleaner conditioner.
	Shiny scratches	May be a metal mark. Make sure surface is cool. Use a safety scraper to carefully scrape off the mark. Apply smoothtop cleaner conditioner and gently rub with nonabrasive nylon pad.
Discoloration	Dirt	Use recommended smoothtop cleaner conditioner to remove dirt from smoothtop.
	Water spots/marks	Make sure surface is cool. Put a small amount of white vinegar on the spot and let sit for a few minutes. Rub with nonabrasive nylon pad. Wipe off any excess with damp paper towel.
	Greenish tinge that fades	Surface elements are either heating or cooling down from a heating cycle. This is normal with some types of smoothtop cooktops.
Hot sugar or plastic melted to surface	Items on top of warm cooktop	Warm slightly and remove with safety scraper.
Pattern fading/wearing off	Dirt/film buildup	Use recommended cleaner conditioner to remove build up and dirt from smoothtop.

Amana Warranty

Full ONE Year Warranty

Amana Appliances will repair or replace, including related labor and travel, any part (f.o.b. Amana Iowa) which proves defective as to workmanship or materials.

Limited Warranty

After one year from the date of original retail purchase, Amana will provide a free part, as listed below, to replace any part that fails due to a defect in materials or workmanship. The owner will be responsible for paying all other costs including labor, mileage, and transportation.

Second through Fifth Year

Amana will provide replacement glass/ceramic cooktop, seal, and electric surface elements, part only (f.o.b. Amana Iowa) which prove defective as to workmanship or materials.

What is not covered by these warranties

- Replacement of household fuses, resetting of circuit breakers, or correction to household wiring or plumbing.
- Normal product maintenance and cleaning, including light bulbs.
- Products with original serial numbers removed, altered, or not readily determined.
- Products purchased for commercial, industrial, rental, or leased use.
- Products located outside of the United States or Canada.
- Premium service charges, if the servicer is requested to perform service in addition to normal service or outside normal service hours or area.
- Adjustments after the first year.
- Repairs resulting from the following:
 - Improper installation, exhaust system, or maintenance.
 - Any modification, alteration, or adjustment not authorized by Amana.
 - Accident, misuse, abuse, fire, flood, or acts of nature.
 - Connections to improper electrical current, voltage supply, or gas supply.
 - Use of improper pans, containers, or accessories that cause damage to the product.

To Receive Warranty Service

Service must be performed by an authorized Amana service representative. To schedule service, contact the Amana dealer where you purchased your appliance or contact Amana Appliances Factory Service.

Amana Appliances Factory Service

1-800-628-5782 inside USA

For more information, Amana Appliances Consumer Services

Amana Appliances

2800 220th Trail

Amana, Iowa 52204

1-800-843-0304 inside USA

(319) 622-5511 worldwide

When contacting Amana Appliances please include the following information:

- Your name, address, and telephone number.
- Model number and serial number of your appliance (found on upper left hand corner of storage drawer opening).
- The name and address of your dealer and the date of purchase.
- A clear description of the problem.
- Proof of purchase (sales receipt).

IN NO EVENT SHALL AMANA BE LIABLE FOR INCIDENTAL OR CONSEQUENTIAL DAMAGES.

This warranty gives you specific legal rights, and you may have others which vary from state to state. For example, some states do not allow the exclusion or limitation of incidental or consequential damages, so this exclusion may not apply to you.

Free Manuals Download Website

<http://myh66.com>

<http://usermanuals.us>

<http://www.somanuals.com>

<http://www.4manuals.cc>

<http://www.manual-lib.com>

<http://www.404manual.com>

<http://www.luxmanual.com>

<http://aubethermostatmanual.com>

Golf course search by state

<http://golfingnear.com>

Email search by domain

<http://emailbydomain.com>

Auto manuals search

<http://auto.somanuals.com>

TV manuals search

<http://tv.somanuals.com>