

Amana

Self Cleaning Gas Range Use & Care Manual

TABLE OF CONTENTS

IMPORTANT SAFETY INSTRUCTIONS	1-4
RANGE FEATURES	5
QUICK REFERENCE INSTRUCTIONS.....	6
HOW TO USE THE COOKTOP	7,8
USING THE COOKTOP DURING A POWER FAILURE ...	9
ENERGY CONSERVATION AND HEALTH TIPS	9
USING THE OVEN	10
OVEN BURNER FLAME	10
SETTING THE OVEN FOR BAKING	11
OVEN COOKING GUIDES	12-14
SOLUTIONS TO BAKING PROBLEMS	15
HOW TO USE THE INFRA-RED BROILER	16
BROILING CHART	17
SELF-CLEANING THE OVEN	18,20
TO INTERRUPT THE SELF-CLEANING CYCLE	20
CLEANING OTHER RANGE PARTS	21
CARE AND MAINTENANCE	22-23
COMMONLY ASKED QUESTIONS	24
ADJUSTING THE OVEN TEMPERATURE	25
SERVICE TONES	25
BEFORE YOU CALL A SERVICE PERSON	26
APPLIANCE SERVICE CONTRACT	26

INSTALLER: PLEASE LEAVE THIS INSTRUCTION MANUAL AND LITERATURE WITH THE CONSUMER.

CONSUMER: PLEASE READ AND KEEP THIS MANUAL AND OTHER LITERATURE FOR FUTURE REFERENCE.

Please Read Before Operating Oven

Part No. 36-308798-03-0

WARNING: If the information in this manual is not followed exactly, a fire or explosion may result causing property damage, personal injury or death.

- Do not store or use gasoline or flammable vapors and liquids in the vicinity of this or any other appliance.
- **WHAT TO DO IF YOU SMELL GAS**
 - Extinguish any open flame.
 - Do not try to light any appliance.
 - Do not touch any electrical switch; do not use any phone in your building.
 - Immediately call your gas supplier from a neighbor's phone. Follow the gas supplier's instructions.
 - If you cannot reach your gas supplier, call the fire department.
- Installation and service must be performed by a qualified installer, service agency or the gas supplier.

WARNING: To reduce the risk of the appliance tipping, it must be secured by a properly installed anti-tip device. To make sure the device has been installed properly, remove the drawer and look under the range with a flashlight.

! WARNING



- ALL RANGES CAN TIP
- INJURY TO PERSONS COULD RESULT
- INSTALL ANTI-TIP DEVICES PACKED WITH RANGE
- SEE INSTALLATION INSTRUCTIONS



NOTICE

THE MAXIMUM GAS SUPPLY PRESSURE FOR THESE MODELS MUST NOT EXCEED 14-INCHES W.C.P.

FOR YOUR SAFETY

DO NOT OBSTRUCT THE FLOW OF COMBUSTION AND VENTILATION AIR.

The California Safe Drinking Water and Toxic Enforcement Act of 1986 requires the Governor of California to publish a list of substances known to the State of California to cause cancer, birth defects, or reproductive harm and requires businesses to warn customers of potential exposure to such substances.

WARNING: The burning of gas cooking fuel and the elimination of soil during self cleaning generate some by-products which are on the list of substances known by the state of California to cause cancer, birth defects, or reproductive harm. To minimize exposure to these substances, always operate this appliance according to the instructions contained in this booklet, wipe up excess food spills prior to self cleaning, and provide good ventilation to the room when cooking with gas and during and immediately after self-cleaning the oven.

IMPORTANT SAFETY PRECAUTIONS

CAUTION

To Avoid the Risk of Personal Injury use this appliance only for its intended purpose as described in this manual.

Do not store items of interest to children in cabinets above a range or on the backguard of a range - children climbing on the range to reach items could be seriously injured.

Do not attempt to clean the oven or broiler burner ignitor assembly, the ignitors are electrically operated and the possibility of electrical shock is present.

To Avoid the Risk of Personal Injury: Do not store items of interest to children in cabinets above your range-top. Children climbing on the range to reach items can be seriously injured.

FOR YOUR SAFETY

Do not store or use gasoline or other flammable vapors or liquids in the vicinity of this or any other appliance.

YOUR RANGE MUST BE INSTALLED AND PROPERLY GROUNDED BY A QUALIFIED TECHNICIAN.

Know where your main gas shut off valve is located.

SAVE THESE INSTRUCTIONS

1. For your safety, top burner flame size should be adjusted so it does not extend beyond the bottom edge of the cooking utensil.
2. The appliance must not be used for warming or heating a room.
3. Do not store items on the rangetop. Items stored on the rangetop can become too hot and melt.
4. Do not mix household cleaning products. Chemical mixtures can interact with objectionable or even hazardous results.
5. **Grease** - Grease is flammable and should be handled carefully. Never leave any cooking operation unattended. Let fat cool before attempting to handle it. Do not allow grease to collect around the rangetop. Wipe up spillovers immediately.
6. **Wear Proper Apparel** - Loose-fitting or hanging garments should never be worn while using the appliance.
7. User **Servicing** - Do not repair or replace any part of the range unless specifically recommended in this manual. All other servicing should be referred to a qualified technician.
8. **Storage in or on Appliance** - Flammable materials should not be stored in an oven or near surface units.
9. **Do Not Use Water on Grease Fires** - Smother fire or flame with a non-flammable lid, or use dry chemical or foam-type extinguisher.
10. **Use Only Dry Potholders** - Moist or damp potholders on hot surfaces may result in burns from steam. Do not let pot holder touch hot heating elements. Do not use a towel or other bulky cloth.

IMPORTANT SAFETY INSTRUCTIONS

Surface Cooking Units:

1. **Use Proper Pan Size** - Select utensils having flat bottoms large enough to cover the flame. undersized utensils may expose the flame to direct contact or clothing.
2. **Surface Cooking Units:** Select utensils having flat bottoms large enough to cover the surface unit heating element. The use of undersized utensils will expose a portion of the heating element to direct contact and may result in ignition of clothing.
3. **Never leave Surface Units Unattended at High Heat Settings** - Boilover causes smoking and greasy spillovers that may ignite.
4. **Utensil Handles Should Be Turned Inward and Not extend Over Adjacent Surface Burners** - To reduce the risk of burns, ignition of flammable materials, and spillage due to unintentional contact with the utensil, the handle of a utensil should be positioned so that it is turned inward, and does not extend over adjacent surface burners.
5. **Glazed Cooking Utensils** - Only certain types of glass, glass/ceramic, ceramic, earthenware, or other glazed utensils are suitable for range-top service without breaking due to the sudden change in temperature.
6. Clean the rangetop with caution. To avoid steam burns, do not use a wet sponge or cloth to wipe up spills on a hot cooking area.

Ovens

1. **Use Care When Opening Door** - Let hot air or steam escape before removing or replacing food.
2. **Do Not Heat Unopened Food Containers** - Build up of pressure may cause container to burst and result in an injury.
3. **Keep Oven Vent Ducts Unobstructed.**

4. **Placement of Oven Racks** - Always place oven racks in desired location while oven is cool. If rack must be moved while oven is hot, do not let potholder contact hot heating element in oven.
5. Do not use aluminum foil or place foods packaged in aluminum foil directly on the rangetop for cooking. Do not line the oven bottom or the oven racks with aluminum foil. Aluminum foil can cause a fire and will seriously affect baking results.
6. The bake and broil burners cannot be operated during a power failure and no attempt should ever be made to do so.
7. Do not touch the interior surfaces of the oven. During and after use, do not touch, or let clothing or other flammable materials contact bake or broil burners "ON" or "OFF" these surfaces can be hot enough to cause burns.
8. Other areas of the oven can become hot enough to cause burns - among these surfaces are the vent openings, window, oven door and oven racks.

Self-Cleaning Oven

1. **Do Not Clean Door Gasket** - The door gasket is essential for a good seal. Care should be taken not to rub, damage, or move the gasket.
2. **Do Not Use Oven Cleaners** - No commercial oven cleaner or oven liner protective coating of any kind should be used in or around any part of the oven.
3. **Clean Only Parts Listed In This Manual.**
4. **Before Self-Cleaning the Oven** - Remove broiler pan, other utensils, and oven racks.

Ventilating Hoods

1. **Clean Ventilating Hoods Frequently** - Grease should not be allowed to accumulate on hood or filter.
2. When flaming foods under the hood, turn the fan off. The fan may spread the flame.

TO AVOID THE RISK OF BURNS:

CAUTION

Due to the nature of cooking, fires can occur as a result of overcooking or excessive grease. Although a fire is unlikely, if one occurs proceed as follows:

SURFACE BURNER FIRES:

1. Do not turn on the vent hood. The fan can spread the flame or the flame may be drawn into the fan causing more damage.
2. Smother the fire with a non-flammable lid or baking soda or use a Class "ABC" or "BC" fire extinguisher.

OVEN FIRES:

1. If you see smoke form your oven, do not open the door.
2. Turn the oven controls to "OFF".
3. As an added precaution, turn off the power at the main circuit breaker or fuse box.
4. Allow food or grease to burn itself out in the oven. If you have a fan you can turn it on to remove the smoke.

OF COURSE, IF SMOKE AND FIRE PERSIST, CALL THE LOCAL FIRE DEPARTMENT. If there is any damage to components, call your repair service before using the range or rangetop again. Remember the best prevention is to keep your range and rangetop free from grease.

CONGRATULATIONS!

You have purchased an appliance that when operated correctly, should give you years of top quality performance. Your range was designed with safety in mind to give you cooking convenience and enjoyment. For future reference, record basic range information found on your range serial plate and retain a copy of your sales receipt for proof of purchase. The product serial plate is located on the oven frame below the oven door. (Open the oven drawer to see the serial plate.)

1. Model Number _____ Serial Number _____
Color _____ Manufacturing No. _____
2. Dealer's Name _____ Phone Number _____
Address _____
3. Date Purchased _____ Date Installed _____
4. Installer's Name _____ Phone _____
Address _____
5. Dealer Recommended Service Center _____
Phone _____
Address _____

RANGE FEATURES

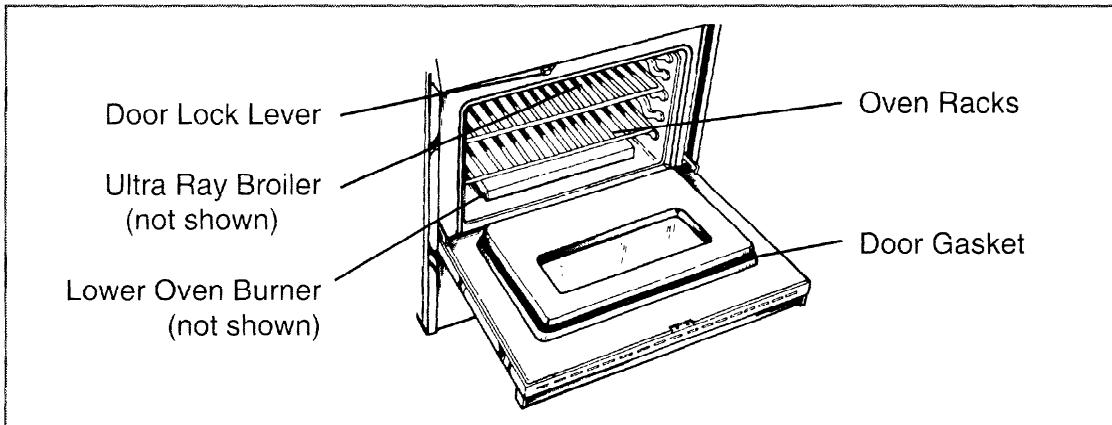

CONTROL PANEL

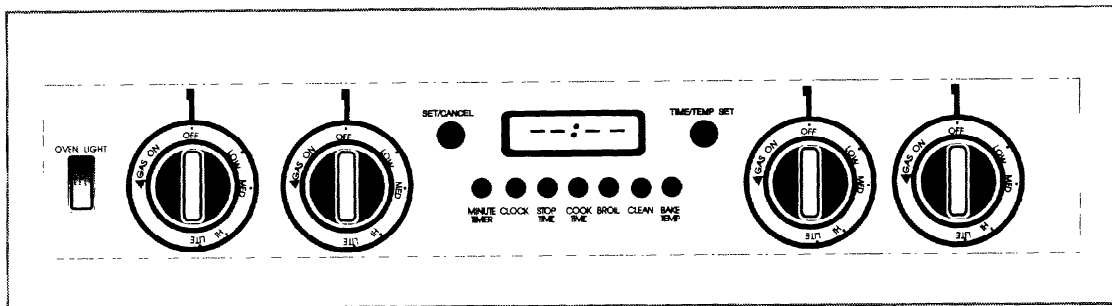

CLOCK DISPLAY

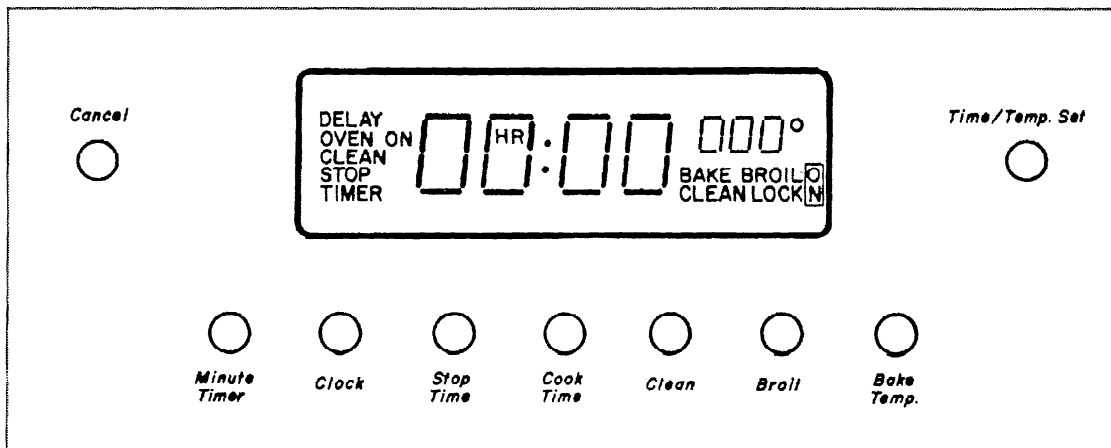

QUICK REFERENCE INSTRUCTIONS

Congratulations on the purchase of your new gas range. We have made every effort to make this range easy to learn and easy to use. To secure the maximum performance from your range it should be installed and used according to the safety instructions. The instructions below have been prepared as a quick reference. If you have any problems or unanswered questions, while using these directions, refer to the detailed sections in your use and care guide.

MAKE SURE YOU HAVE READ ALL OF THE SAFETY INSTRUCTIONS BEFORE YOU BEGIN TO OPERATE YOUR RANGE.

CLOCK AND OVEN CONTROLS

SETTING THE CLOCK

1. Push the Clock Button.
2. Turn the Time/Temp Set knob to the desired time of day.

SETTING THE MINUTE TIMER

1. Push the Minute Timer button.
2. Turn the Time/Temp Set knob to the desired amount of time. The timer can be set from 5 seconds to 11 hours and 59 minutes.
3. To cancel the Minute timer Push the Minute Timer button and hold it down for 3 seconds.

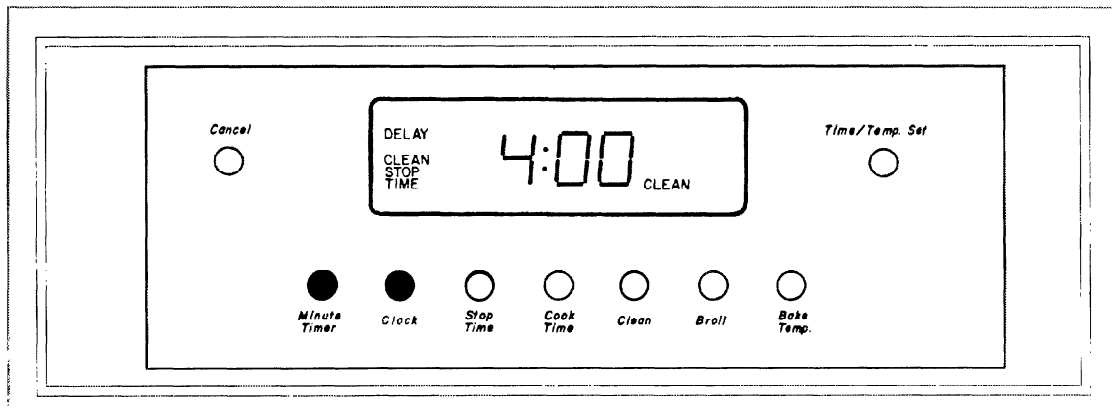

BAKING AND BROILING

1. Push the button that corresponds with the function you desire.
2. Turn the TIME/TEMP set knob to adjust the temperature.
3. After 3 seconds the oven will start.

SETTING DELAYED BAKE OR CLEAN

1. Push the function you desire.
2. Turn the TIME/TEMP knob to the desired temperature.
3. Push the COOK TIME button.
4. Turn the TIME/TEMP set knob to the desired cooking time.
5. Push the STOP TIME BUTTON.
6. Turn the TIME/TEMP knob to the desired stopping time.

HOW TO USE THE COOKTOP

Your Range has been factory set for use with Natural Gas. If you want to use L.P./ Propane Gas, detailed instructions are provided in the Installation Instruction Manual. It is recommended by the manufacturer that the conversion be done by a qualified service technician.

1. USE THE PROPER PAN SIZE

Select utensils that have flat bottoms large enough to cover the flame.

Using undersized utensils will expose a portion of the flame to direct contact with clothing or spillovers. A utensil that is correctly sized will also improve efficiency.

2. NEVER LEAVE SURFACE UNITS UNATTENDED

At high heat settings boilovers can cause smoking or fire.

3. GLAZED COOKING UTENSILS

Only certain types of glass, glass/ceramic, earthenware or other glazed utensils are suitable for use with range top. Due to the sudden change in temperature some glazed cooking utensils may break.

4. UTENSIL HANDLES SHOULD BE TURNED INWARD

A handle that extends away from the range could be unintentionally tipped.

COOKING UTENSILS

GLASS-CERAMIC cookwear responds slowly to temperature changes. It responds best to long and slow heating of liquids.

ALUMINUM responds quickly to temperature changes. It responds best for frying, braising and roasting.

CAST IRON responds slowly to temperature changes. It responds best for long low-heat cooking and pan frying.

STAINLESS STEEL is usually combined with another metal such as copper, to better respond to temperature changes. It may be used for soups, sauces, vegetables and general cooking.

COPPER, TIN-LINED cookware responds quickly to temperature changes. It is excellent for gourmet cooking, wine sauces and egg dishes.

ENAMELWARE is stain resistant porcelain over metal. The cooking time can be determined by the base metal, however,

lower temperatures are usually recommended.

When you select cookware, the pan design is as important as the material. For the best efficiency and results, select pans with the features listed below.

- FLAT BOTTOMS AND STRAIGHT SIDES
- HANDLE WEIGHT THAT DOES NOT TILT THE PAN
- MATCH THE PAN SIZE TO THE BURNER SIZE

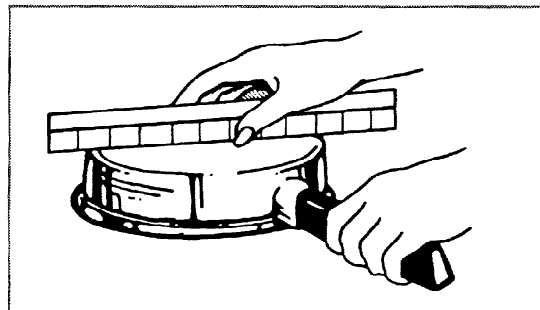

OPERATING THE COOKTOP

TO USE:

1. Push in and Turn the control to LITE. The burner will make a sparking sound.
2. The burner will automatically light.
3. Turn the knob to the desired setting and the burner will stop sparking.

The burner control may be turned to any position between the settings indicated to achieve the desired flame setting.

WHEN FINISHED:

1. Turn the control to OFF.

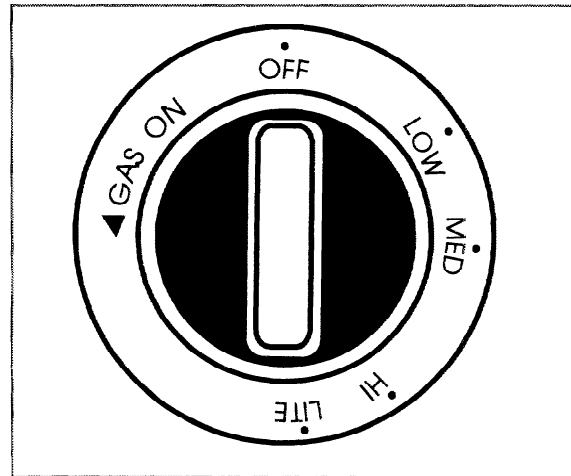

TOP BURNER SETTINGS

When the burner is set on LOW the flame should be adjusted to the minimum steady blue flame (Approx. 1/4" flame length).

Check the adjustment by turning from high to low several times to see that the burner does not go out. The controls have distinct click positions for setting the flame at HIGH, MED and LOW. This flexibility is one of the reasons why good cooks prefer gas. They know temperatures must adjust exactly, and instant changes are necessary for cooking perfection.

Use the Illustrations below as a guide.

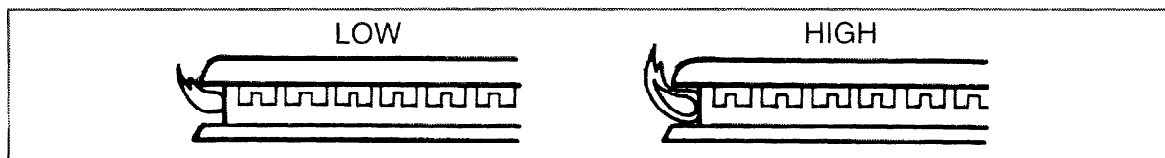

FLAME ADJUSTMENT

If the LOW burner flame is not a steady blue flame approximately 1/4", it can be adjusted using the adjustment screw in the center of the valve stem. The valve stem is located directly behind the control knob. The HIGH flame should be a steady flame with a distinct inner cone.

TO ADJUST THE FLAME:

1. Remove the control knob.
2. Using a small flathead screwdriver turn the screw located in the center of the knob stem until the flame is the proper size.
3. Replace the control knob.
4. Test the flame by turning the control from LOW to HIGH and checking the flame at each setting.

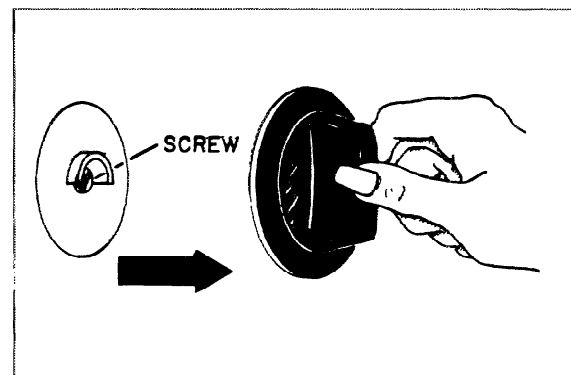

OPERATING THE COOKTOP

OPERATING THE COOKTOP DURING A POWER FAILURE

Although the system used to light the burner is electric, it is possible to use the top burners should a power failure occur. Follow the instructions below in case of a power failure:

1. Hold a lit match at the desired burner head.
2. Push in and Turn the control to LITE.
3. Turn the control to the desired setting when the burner is lit.

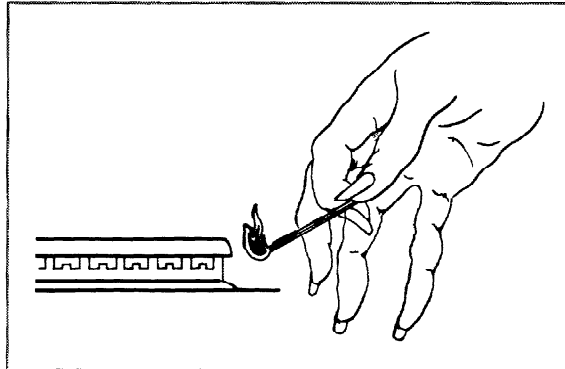

WHEN FINISHED:

1. Turn the control to OFF.

Note: The oven and broil burners should never be used during a power failure

ENERGY CONSERVATION AND HEALTH TIPS

Cooking utensils must cover the entire flame. An undersized utensil will expose the outer portion of the flame wasting heat and energy. The cooking utensils should sit flat on the elements and not be warped. Empty pans should not be left on the flame. Leaving utensils on the flame can cause damage to both the utensils and the range top.

USE OF WATER AND LIQUID

Foods cook faster in small amounts of water. If liquid remains after cooking, serve it with the food or save it. Many vitamins dissolve in cooking water and are lost if the liquid is drained and discarded.

LIDS AND COVERS

A tight fitting lid gives a utensil a more efficient performance. It helps to maintain even temperatures and hold in odors and steam. Covering pans will help foods cook faster and minimize clean-up.

⚠ WARNING

The flame should not extend beyond the edge of the cooking utensil. It may contact clothing or potholders and cause a fire.

USING THE OVEN

OVEN RACKS

Both oven racks may be used for conventional baking and roasting. They will pull to a "stop" position without tipping.

To Remove the Racks:

1. Pull it forward to the first "stop" position.
2. Raise the forward edge of the rack (as show below) and pull it past the second "stop".

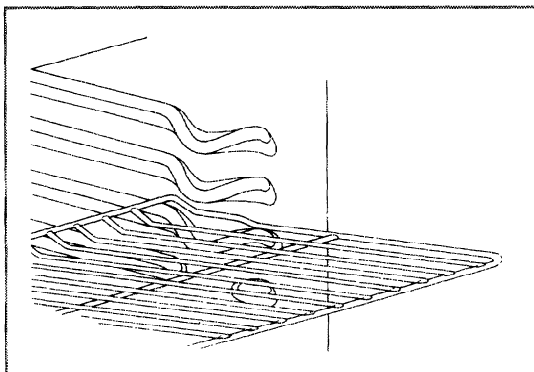

PAN PLACEMENT

When placing baking pans and cookie sheets, the pans should be kept a distance of two inches from the side and rear walls. If roasting or baking pans are placed on different shelves, they should be staggered so that one is not located directly under another. This will assure good distribution of heat and will allow food in both pans to be thoroughly cooked.

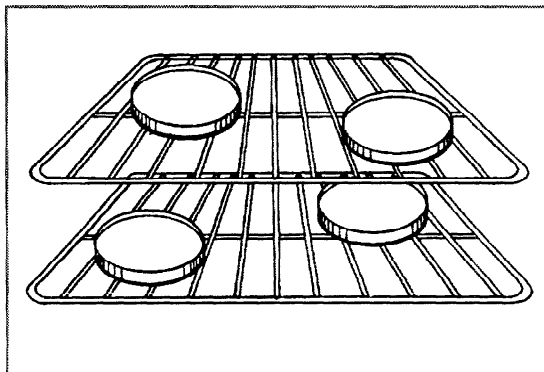

⚠ WARNING

Never attempt to use the oven or broil burners during a power failure.

⚠ IMPORTANT

Never cover the oven racks with aluminum foil. This will seriously affect baking results.

THE OVEN BURNER FLAME

The oven burner flame should be a clean blue flame with distinct inner cones 1/4 to 1/2 inch long. A soft lazy flame without distinct inner cones means the flame needs to be adjusted. A noisy or blowing flame needs to be adjusted. The oven burner flame is factory set and should be checked by the installer. If the flame needs to be adjusted check the installation instructions for steps to follow or call a service person.

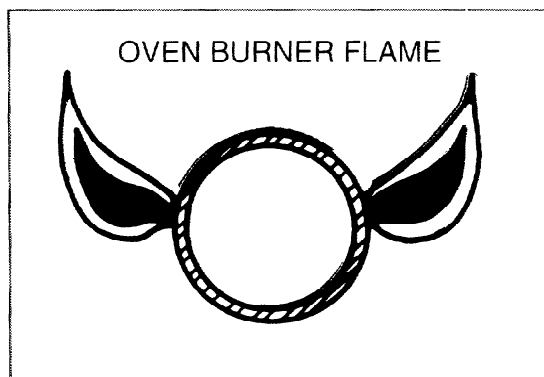

SETTING THE CONTROLS

BAKING / ROASTING

TO USE:

1. Press the Bake Temp button. BAKE and ___° will light in the display.
2. Turn the Temp. Set knob to adjust the temperature.
3. The oven will begin cooking in 3 seconds and ON will light in the display.

ture display will drop to 100°. As the oven heats the temperature will rise on the display until it reaches the set temperature. If you want to adjust the oven temperature while you are cooking, Press the Bake Temp button and adjust the temperature using the Temp Set knob.

WHEN FINISHED:

1. Press the Cancel button.

WHAT TO EXPECT:

When the oven begins to heat the tempera-

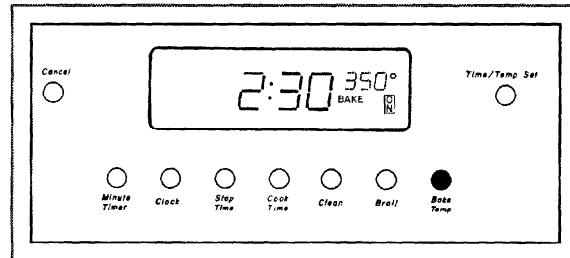

SETTING THE OVEN FOR DELAYED BAKING

1. Press the Cook Time button. OVEN and TIME will light in the display.
2. Turn the Time Set knob until the desired amount of cooking time is displayed.
3. Press the Stop Time button. STOP TIME and the earliest possible stopping time will light in the display.
4. Turn the Time Set knob to the time of day you want the oven to stop. DELAY OVEN will light in the display.
5. Press the Bake Temp button. BAKE will light in the display.
6. Turn the Temp Set knob to adjust the oven temperature. The temperature can be adjusted from 170° to 550°.
7. The oven will begin cooking at the pre-set time and ON will light in the display.
8. When the cycle is complete the oven will "beep" until you Press Cancel.

stopping time. The oven will begin at the pre-determined time. DELAY will disappear from the display and ON will light in the display. The temperature display will drop to 100° and begin to rise with the oven temperature. The oven will automatically stop cooking at the pre-set time. When the oven is finished cooking it will continue to "beep" until you press the Set/Cancel button.

NOTE: You can check any of the pre-set times by pressing the corresponding buttons. For example to check the stop time Press the Stop Time button.

WHAT TO EXPECT:

The control will automatically calculate the starting time based on the cooking and

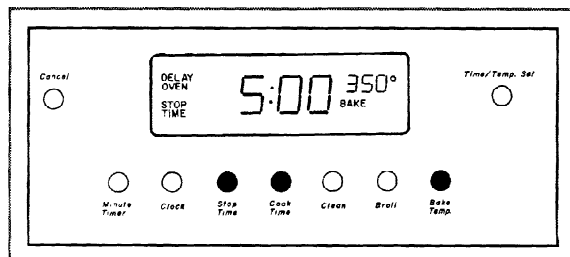

OVEN BAKING GUIDE

Hot Oven 400° - 500°F • Moderate Oven 350° - 375° • Slow Oven 300° - 350°F

Follow this guide for time and temperature unless they are given in the recipe you are using. Baking time will vary with temperature of ingredients and size and type of utensil being used. However, if the oven temperature is correct, the time should not vary more than that given in the guide.

TEMPERATURE		
FOOD	DEGREES	MINUTES
YEAST BREADS		
Bread	400°	45-60
Rolls	375°	25-30
QUICK BREADS		
Baking Powder Biscuits	450°	12-15
Muffins	425°	20-25
Popovers	375°	45-60
Popovers with oven meal	350°	60-75
Nut Bread	400°	50-60
Corn Bread	375°-400°	30
COOKIES		
Drop	350°-375°	20-25
Rolled	375°-400°	8-12
Sliced	375°-400°	8-12
Brownies	350°	25-30
PIES		
Pie Shells	475°	10-15
Custard	400°	35-40
Pumpkin	475°	10-15
Apple	400°	45-60
Berry	425°	45-60
Mince	425°	35-40
CAKES		
8" Layer	375°	25-30
9" Layer	350°	30-35
Cup Cakes	375°	20-25
Loaf Cakes	350°	45-60
Angel Food	350°	40-50
Sponge	350°	40-50
Jelly Roll	425°	12-15
Fruit	250°-275°	2-4 Hrs.
Gingerbread	350°	30-50

CONVENTIONAL ROASTING

For best results, a shallow pan close to the size of the meat is recommended. The broiler pan can be used if necessary.

Place the meat on a rack or grid with the fatty side up. Do not cover or add water.

Place the pan on the oven rack with the center of the meat in the center of the oven.

Set the Oven Control to the desired temperature. Refer to the Roast Guide in this section.

USEFUL INFORMATION

When roasting frozen meats, allow 1/3 to 1/2 more cooking time than for roasts already thawed.

After cooking is complete, allow the roast to stand 15 to 20 minutes before carving.

Rare or medium rare meats can be removed slightly before they are ready; they will continue to cook while the roast is standing to be carved.

Meats and poultry prepared in the dry "roasted" method should not be covered; nor should water be added prior to roasting.

ROAST GUIDE

(An aid for roasting times and temperatures)

FOOD	OVEN TEMP.	MIN./ LBS.
BEEF		
• Roasts	325°	
rare		20-25
medium		26-30
well done		33-35
• Rolled Roasts	325°	
rare		32-36
medium		36-40
well done		43-45
PORK (fresh)	325°	
• Fresh Ham (whole)		22-28
• Loin		35-40
• Shoulder, Butt		40-45
• Shoulder, Picnic		35-40
HAM (smoked mild cure) ...	350°	
• Picnic Shoulder		30-35
FOOD	OVEN TEMP.	APPROX. COOK TIME IN HRS.
CHICKEN*	375°	
• 4 to 5 lbs.		1-1/2 to 1-3/4
• over 5 lbs.		1-3/4 to 2
TURKEY**	325°	
• 6-8 lbs.		3-1/2 to 4
• 8-12 lbs.		4 to 4-1/2
• 12-16 lbs.		5-1/2
• 20-22 lbs.		7 to 8-1/2
DUCK	325°	
• 3-5 lbs.		1-1/2 to 2
GOOSE	325°	
• 6-8 lbs.		3 to 3-1/2

* Small chickens can also be roasted at 400° for darker browning. If so, the cooking time should be shortened.

** For stuffed turkey or duck, cooking time may increase 15 to 20 minutes.

KEEPING FOOD WARM

The Keep-Warm oven can be helpful in many ways.

If you wish to use the Keep-Warm feature immediately after baking at a higher temperature, set the oven to the correct temperature (see chart) and open the oven door for 10 to 15 minutes to allow excess heat to escape.

Arrange the food for serving on the platter. A Warm, setting will not damage china.

NOTE: If you plan to keep food warm on a platter, be sure the oven has cooled after baking before placing the platters in the oven.

TO AVOID THE RISK OF FIRE, DO NOT USE PLASTIC PLATTERS, OR SILVER TRAYS IN THE KEEP-WARM OVEN.

To prevent moist foods such as cooked vegetables, mashed potatoes, gravy, yeast rolls, biscuits, etc. from drying out, they should be covered tightly before being placed in the oven. Aluminum foil is ideal for this.

Meat can be carved ahead of time and then kept warm. Sliced meats must be covered lightly with dampened paper towels or a wet towel to prevent cut surfaces from drying. If you wish to slice rare or medium meats you can do so if you do not allow the cut surfaces to remain exposed to the air. Cut the slices as described but keep the surfaces close together.

THAWING FROZEN FOODS

The oven may be used for thawing frozen foods. Poultry should only be thawed until the giblets can be removed. Thaw cut-up poultry, fish or meat cuts just enough to separate the pieces. Ground meat should be thawed just enough to allow you to mix and form it. Once the food is thawed, cook it immediately. Do not refreeze food that has been thawed.

To thaw and freshen cooked frozen baked goods, use the Warm setting. Wrap food loosely to prevent drying but to permit the evaporation of ice crystals formed during freezing.

KEEP-WARM OVEN CHART

BACON	225°
BEEF	
Rare	170°
Medium	170°
Well Done	170°
FISH	
Baked or Broiled (loosely covered)	170°
HAM	170°
LAMB	170°
PORK	
Fresh	170°
Smoked	170°
POULTRY	
Roasted	170°
Fried	170°
SEAFOOD	
Baked or Fried (loosely covered)	170°
VEGETABLES	
(covered)	170°
BISCUITS/MUFFINS	170°
CASSEROLES	200°
GRAVY	170°
PIZZA	
(loosely covered)	225°
ROLLS	
(tightly wrapped)	170°
DEEP FAT FRIED FOOD	200°
POTATOES	
Baked	200°
potatoes	170°
(loosely covered)	250°
PIES/PASTRY	170°

BAKING PROBLEMS, REASONS WHY, WHAT TO DO:

PROBLEM	REASON WHY	WHAT TO DO
Cookies, biscuits, burn on bottom	Oven preheat time too short.	Allow oven to preheat to desired temperature.
	Oven shelf overcrowded.	Select pan sizes that leave air-space on all sides of pan.
	Pan heats too fast.	Use light colored baking sheets.
Bread does not rise in oven.	Oven is too hot.	Reduced temperature or recheck oven setting.
Bread loaf bakes over pan, poorly shaped.	Oven temperature too low.	Recheck oven temperature
Cakes not baked in center.	Oven too hot.	Set oven temperature 25 degrees, lower and bake recommended time.
	Type and size of pan.	Use suggested pan size, glass baking dishes usually bake at a lower temperature.
Cakes fell.	Underbaked, oven door opened too often.	Keep oven door closed. Bake recommended time.
Cakes not level.	Range or oven shelf not level	Place a marked glass measuring cup, filled to one marking with water, in center of oven rack. If water level is uneven, refer to installation instructions for leveling range.
	Pan too close to oven wall.	Allow minimum of 1-1/2 inches clearance on all sides.
Foods undercooked after recommended cooking time has elapsed.	Oven not up to temperature.	Set oven temperature 25 degrees higher and bake recommended time.
	Improper use of foil.	Foil should not be placed on floor of oven, over a cooking shelf or thermostat bulb.

USING THE INFRA - RED BROILER

The broiler uses infra-red rays that travel in straight lines. These rays will sear the outside of the food while locking in all the flavor and juices. The cooking area of the broiler will get smaller as the food is moved closer to the element. In high rack positions, the rays will not reach the corners of the broiler grid. If you have never used an infra-red broiler, follow this rule of thumb:

Outside Charred and Inside RareHigh Rack position and short time
Outside Charred and inside Well Done Lower Rack position and less time

SPECIFICS

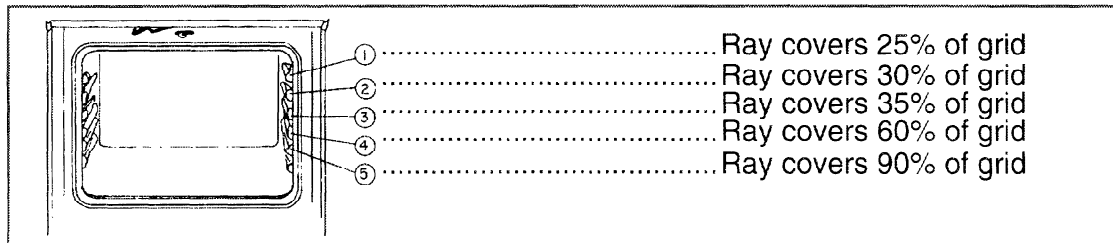

BROILING TIPS

1. The best foods to broil include steaks, hamburgers, chicken, fish, pork or lamb chops and vegetables.
 2. Remove excess fat from the meat and slash the edges to prevent them from curling.
 3. Do not pierce meats before or after broiling. If the meat has been pierced it may lose some juices.
 4. Season the meat after it has browned. Uncooked meat that is seasoned may become tough.
 5. Broiled food, EXCEPT FOR FISH, should be turned at least once.
 6. Fish should be broiled with the skin side down.
 7. Broil hamburgers on shelf position 4.
- NOTE: The broiler does not need to be preheated before using.**

⚠ WARNING

Do not line the broiler pan with foil. Foil will not allow grease and liquids to drain from the food causing smoking or fire.

BROILER PAN POSITION

Position broiler pan with short sides parallel to the back of the oven so that it is directly lined up under the broiler.

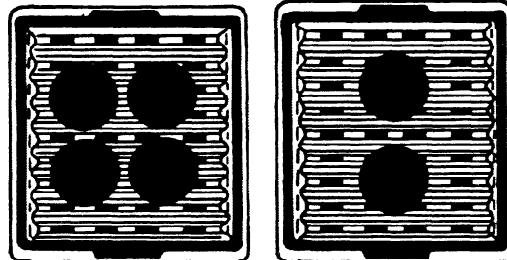

BROILING

TO USE THE BROILER

TO BROIL:

1. Push the Broil button. Broil and $_ _ _$ will appear in the display.
2. Turn the Temp Set knob to "HI" or "LO."
3. BROIL and ON will remain in the display.

WHEN FINISHED:

1. Push the Cancel button

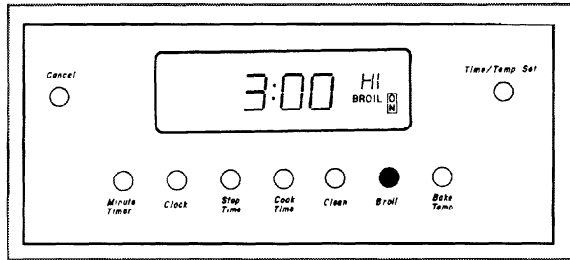

BROILER FLAME

The broiler flame should be a soft hazy flame no larger than 3/8 inch thick. Blowing or lifting of the flame should not occur. If the burner has any other appearance than what is shown it may need to be cleaned or adjusted by a qualified service person.

INFRA - RED BROILER FLAME

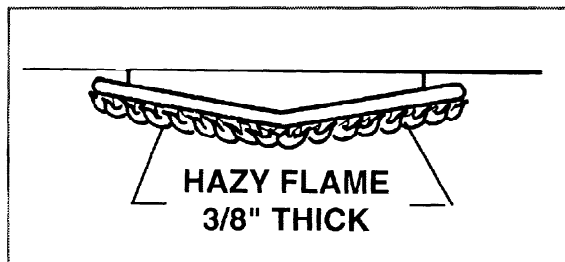

BROILING CHART

FOOD	BROILING TIME(MIN.)
BEEF	
Steaks (1" thick)	
Rare	10
Medium Rare	11
Medium	12-14
Well Done	20
Steaks (1-1/2" thick)	
Rare	15
Medium	20-25
Well Done	30
Steaks (2" thick)	
Rare	20
Medium	30-35
Well Done	40
Ground Beef Patties (3/4" to 1" thick)	8-15
FISH	
Fillets or Steaks	10
LAMB	
Chops or Steaks	
1" thick	8-10
1-1/2" thick	12-14
2" thick	14-16
PORK (cured)	
Bacon	2-6
Ham Slice (cook before eating)	
1/2" thick	19-20
1" thick	20-30
Ham Slice (fully cooked)	
1/2" thick	19-20
1" thick	20-30

SELF CLEANING THE OVEN

STEPS TO FOLLOW BEFORE SELF CLEANING

1. Remove all containers, spoon holders, spices and etc., from the range top.
2. Remove all pots, pans and oven racks from inside the oven. These things will become too hot during the cleaning cycle causing them to warp.
3. Wipe up the excess spills from the oven interior.
4. Remove soil from the oven frame, side of door and door liner.

! WARNING

Do not clean the oven door gasket. The gasket can be damaged as a result of rubbing or moving.

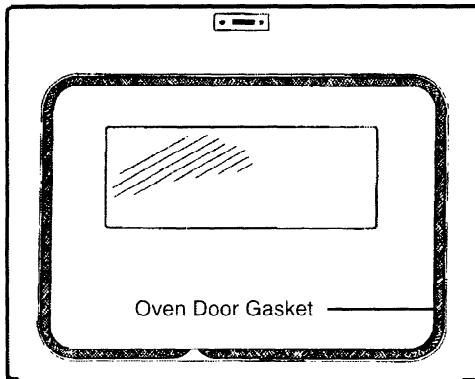

TIPS ON SELF-CLEANING

- The best time to clean your oven is in the evening, when you are finished using it for the day.
- A small amount of smoke is normal, excessive smoke may indicate that there is a faulty gasket or too much food has been left in the bottom of the oven.
- The oven should always be cleaned before it gets too dirty. If you cannot clean your oven in one cycle, repeat the cleaning cycle.
- Never use a chemical oven cleaner. Some chemicals may have a reaction in the oven interior at high temperatures.
- The oven frame and the part of the door liner that is outside the oven seal need to be wiped off before the cleaning cycle. These areas aren't reached during automatic cleaning, but they do get enough heat to bake on soil and make it harder to remove.

! WARNING

To reduce the risk of severe burns, do not obstruct or touch areas near the vents or range surface. These areas become hot during the cleaning cycle.

SUGGESTED SELF CLEANING TIMES

LIGHT TO MODERATE SOIL 2 HOURS
HEAVY SOIL 3-4 HOURS

SELF CLEANING THE OVEN

SETTING THE SELF CLEANING CYCLE

TO CLEAN:

1. Remove everything from inside the oven, and lock the door lock lever as shown above. LOCK will light in the display.
2. Push the Clean button. CLEAN will light in the display.
3. Turn the Time Set knob to 3 hours.
4. The oven will automatically begin to clean in 3 seconds and ON will light in the display.

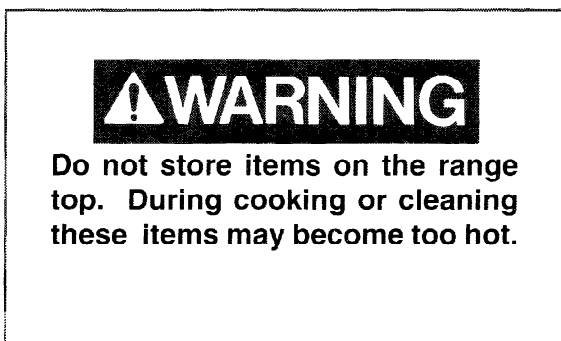
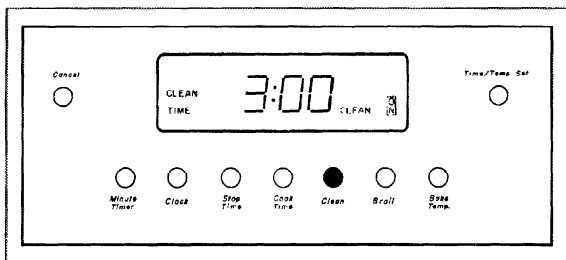
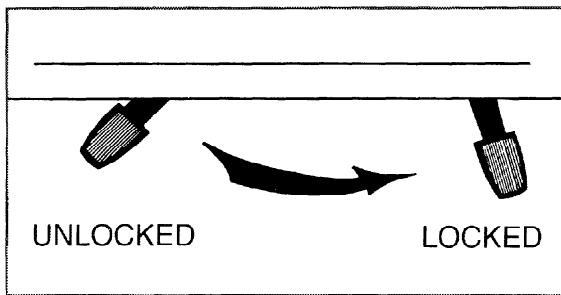

SETTING THE SELF-CLEANING CYCLE TO START AND STOP AUTOMATICALLY

1. Remove everything from the oven and lock the door lock lever as shown above. LOCK will light in the display.
2. Push the Clean button. CLEAN will light in the display.
3. Turn the Time Set knob to 3 hours.
4. Push the Stop Time button. The earliest possible stopping time will appear in the display.
5. Turn the Time Set knob to adjust the stopping time.
6. The control will automatically compute a starting time based on the clean and stop time you entered. DELAY CLEAN STOP TIME and LOCK will appear in the display.
7. When the oven begins, CLEAN and ON will appear in the display.

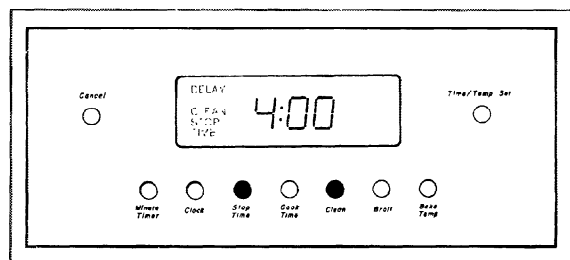

NOTE: If the door is not locked "DOOR" will appear in the display.

SELF CLEANING THE OVEN

WHAT TO EXPECT DURING SELF CLEANING

- The oven and the clean indicator lights will be on until the cleaning cycle is finished.
- The first few times the self-cleaning cycle is used, there may be some minor smoking and slight odor as the oven insulation "cures." This will disappear after the first few cleaning cycles.
- Vapor and warm air will pass through the oven vent. Do Not Obstruct the Air Flow.
- The vapor and smoke that is generated during the self-cleaning cycle is cleaned before it is discharged into the room.
- The outer surfaces of the range will become hot. Do Not Touch The Outer Areas Of The Range During Self Cleaning.

WARNING

Do not store or place any combustible materials, gasoline or other flammable liquids near your range.

TO INTERRUPT THE SELF CLEANING CYCLE

1. Press the Cancel button.
2. Do not attempt to open the door lock lever until the oven has cooled for atleast 30 minutes.

NOTE: Do not use the door lock lever when you are baking. Moving the lever to the right will cancel the bake setting. If you accidentally lock the door, you must unlock it and re-set the cooking function.

CAUTION

Do not try to force the oven door open. This can damage the automatic door locking system.

CLEANING RANGE EXTERIOR

Exterior painted surfaces and trim can be cleaned with cloth and soapy water or a low-abrasive cleaner. No abrasives, gritty cleaners or steel wool should be used.

The glass on the control panel should be cleaned only with a damp cloth, never with scouring powder or steel wool. All control knobs can be pulled off to simplify cleaning.

Be sure to note the position of the knobs so they can be replaced on the proper control in

their original position. **DO NOT** use scouring pads to clean Control Knobs. The numbers can be rubbed off the Knobs by the abrasive action of the pad.

Remove oven racks and wash in hot, soapy water.

Broiling and roasting pans should be washed after every use. Pour off drippings and wash in hot, soapy water. Aluminum foil placed in the bottom of broiling pan will simplify your clean-up.

CLEANING THE RANGE TOP

Make sure your cooktop is cool before you begin cleaning. Sudden temperature changes can cause the enamel burner caps to crack. To prevent the possibility of stains wipe up all spills immediately with a dry cloth. Acids will stain even the most stain-resistant materials and finishes, so take extra care when you are cooking with vinegar, milk, lemon juice and sauces with tomatoes.

CLEANING BURNER CAPS AND GRATES

To clean the burner caps and grates use a damp cloth and warm soapy water. If necessary use a non-abrasive cleaner or pad. **DO NOT USE** harsh powders, scouring pads or steel wool pads. **NEVER** use oven cleaners on the surface of your range.

FOR BURNED OR DRIED ON SOIL soak the burner caps and grates in warm soapy water.

Be sure when you clean the burners that all of the ports are unobstructed.

When cleaning the burners pay close attention to the small slot above the ignitor. (As shown below). If this slot is blocked it will result in poor top burner ignition. Take care when you replace the burner caps. Make sure that they fit securely over the burner body. The caps must fit correctly to operate the burner properly.

WHEN FINISHED:

Make sure you have dried all of the burner components to prevent any rusting that might occur. Allow the ignitors to dry before you attempt to light the burners.

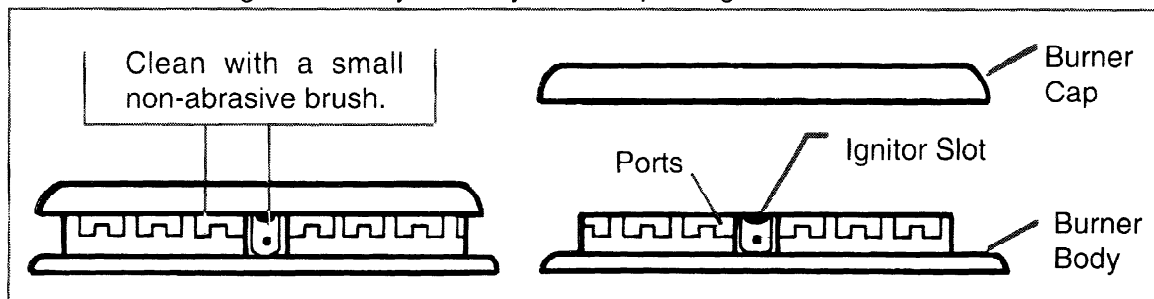

CARE AND MAINTENANCE

REMOVABLE OVEN DOOR

The oven door is removable for convenience when cleaning. Do not immerse the oven door in water.

TO REMOVE OVEN DOOR:

1. Open the door to the first stop position (approximately 5 inches).
2. Grasp the door firmly at each side and lift it upward and off the hinges.

CAUTION

OVEN DOOR IS HEAVY.

TO REPLACE THE OVEN DOOR:

1. Align the door with the hinge arms.
2. Slide the door down and into place. Be sure the door is all the way down on the hinges before closing, to prevent the possibility of chipping porcelain or scratching chrome.

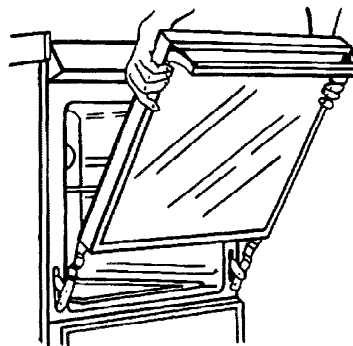

STORAGE DRAWER

The storage drawer is for storing pots and pans. The drawer can be removed to make it easier to clean under the range.

TO REMOVE THE STORAGE DRAWER:

1. Pull the drawer straight out to the first stop. Lift the front and pull out to the second stop.
2. Let the front of the door rest on the floor. Place your hands toward the back of the drawer and lift it out.

TO REPLACE THE STORAGE DRAWER:

1. Place the set of rollers on the drawer behind the set of rollers on the oven. (As shown in figure 2)
2. Align the guides and push the drawer back into position.

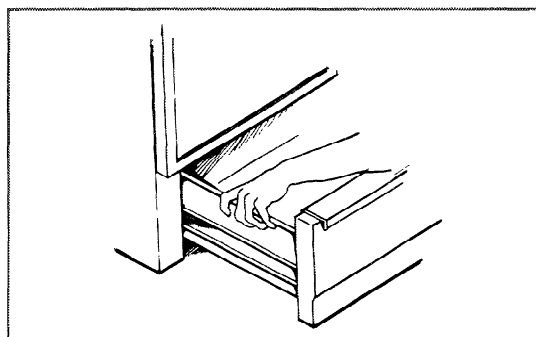

FIGURE 1

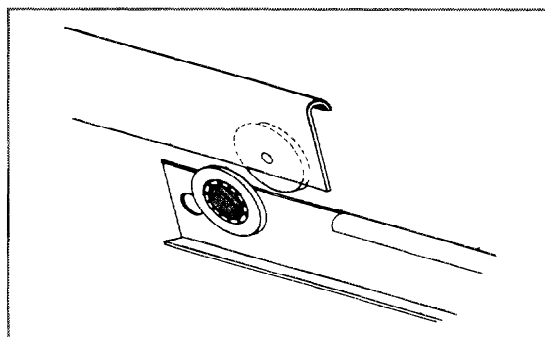

FIGURE 2

REPLACING THE OVEN LIGHT

⚠ WARNING

Make sure the oven, light cover, and bulb are cool before you begin. Be sure the oven power is off. You can turn it off at the main fuse or circuit breaker

DO NOT USE THE OVEN WITHOUT THE BULB COVER PROPERLY IN PLACE.

⚠ WARNING

You must replace the cover after changing the bulb. The cover protects the bulb from becoming too hot. Be careful not to drop the bulb on cover. They are made of glass and can cause serious injuries if broken.

STEPS TO CHANGE THE LIGHT:

1. Disconnect the oven power at the main circuit breaker.
2. Unscrew the glass cover counterclockwise.
3. Unscrew the light bulb counterclockwise.
4. Replace the bulb with a 40-watt appliance bulb.
5. Replace the bulb cover.
6. Reconnect the power to the oven.

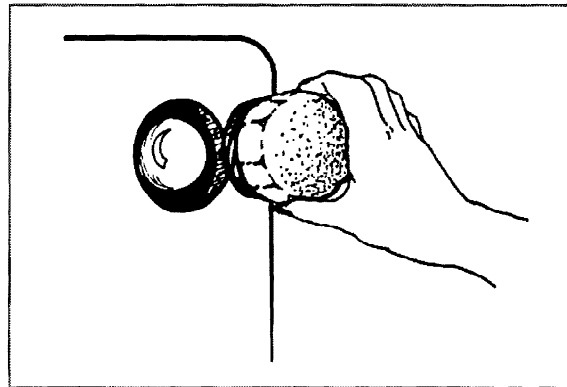

NOTE: Do Not Over Tighten The Bulb Cover. Replace the cover so it is secure but not tight. After repeated use of the oven, a cover that has been over tighten will be very difficult to remove.

HOOD EXHAUST SYSTEMS SAFE OPERATION

⚠ CAUTION

Clean ventilating hoods frequently. Grease should not be allowed to accumulate on hood or filter.

⚠ CAUTION

When flaming foods under the hood, turn the fan off. The fan, if operating, may spread the flame.

COMMONLY ASKED QUESTIONS

Question: I've put an oven thermometer in my oven and noticed it does not maintain a constant temperature. Do I have a problem?

Answer: To maintain a temperature for baking, your oven will cycle off and on. You may see a "swing" in temperature of as much as $\pm 25^{\circ}\text{F}$. This temperature cycling is considered a normal procedure in range operation.

Question: Is it normal for my range-top to get warm during use?

Answer: The porcelain rangetop may become warm to the touch while the range is being used to bake, broil or self-clean. The longer the range is operated, the more the heat can be conducted to the rangetop.

Question: If my range clock is not working can I still self-clean my oven?

Answer: No. Your oven control uses the oven clock to help start and stop your self-clean cycle.

If the oven does not heat: Check to be sure the oven has been set to the correct temperature and/or that the oven is not set for a delayed bake function.

If the clean cycle does not start: Check to see that the oven timer is not set for a delayed start.

Question: Can I use the Timer during oven Cooking?

Answer: The timer can be used during any cooking function and is especially handy when baking or broiling. The Timer can also be used while you are using the automatically timed functions.

Question: Should there be any odor during the cleaning cycle?

Answer: Yes. There may be a slight odor during the first few cleaning cycles. Failure to wipe out excessive soil may also cause an odor when cleaning.

Question: What should I do if excessive smoking occurs during cleaning?

Answer: This is caused by excessive soil, and you should press the CANCEL button to shut the oven off. Open windows to rid room of smoke. When the oven has cooled and the door unlocks, wipe up the excess soil and reset the cycle.

If the latch lever cannot be moved to an unlocked position: The oven must be cool to move latch lever to the left or to an unlocked position. If the latch does not unlock after the oven has cooled call your dealer or an authorized service agency.

DO NOT FORCE THE LATCH LEVER. IF THE LEVER IS FORCED OPEN THE COSTLY SELF-CLEAN MECHANISM WILL BE DAMAGED.

ADJUSTING THE OVEN TEMPERATURE

HOW TO ADJUST OVEN TEMPERATURE

The oven has been calibrated at the point of manufacture. However, if you wish to adjust the oven temperature to make it bake hotter or cooler, follow these steps.

To Adjust The Temperature:

1. Push the Bake Temp button once.
2. Turn the TIME/TEMP SET knob clockwise until an oven temperature greater than 500°F shows in the display.
3. Immediately push and hold the BAKE TEMP button until "00" appears in the display (approximately 5 seconds).
4. **To decrease the oven temperature (for cooler oven):** Turn the TIME/TEMP SET knob clockwise until the negative number (-05 through -35 in five degree increments) that represents the °F you wish to select appears. For example, if you want to decrease the oven temperature 20°F you select -20.
5. **To increase the oven temperature (for hotter oven):** Turn TIME/TEMP SET knob clockwise past the negative numbers until the positive numbers (05 through 35 in five degree increments) appear. Select the number which represents the °F you wish to increase the oven temperature. For example, if you want to increase the oven temperature 15°F you select 15.
6. Push SET/CANCEL button to enter this new oven temperature adjustment. Your oven bake and broil temperatures are now adjusted hotter or cooler as you have selected. This temperature adjustment is retained, even through power interruptions.

SERVICE TONES

If the oven control sounds a series of short, rapid beeps and the display shows a diagnostic service code (F0-F9) service tone for over 16 seconds, disconnect the service breaker and unplug the range. Next, contact your nearest authorized service person and indicate which diagnostic service code has appeared in your display. Each diagnostic service code indicates which part of the control or oven needs to be checked by the service person.

F0 - indicates a problem with the CANCEL button operation.

F1 and F7 - indicate a possible short in the control.

F3, F4, F5 and F8 - The service tone will continue to occur when the oven is used for bake, broil or clean operations. You will need to call a service person.

F6 - the control will not sound a service tone when this code appears in the display, however you will need to call a service person and have it checked.

F9 - the door lock mechanism needs to be checked by a service person.

Fd - bake or broil elements need to be checked by a service person.

Note: If the electronic control should ever flash through the different features, you have probably programmed the sales-demo mode. Press the cancel button to clear the display.

BEFORE YOU CALL A SERVICE PERSON

Make sure you have followed the instructions in your Use and Care Manual. Avoid unnecessary service calls for difficulties that are not a result of defective workmanship or materials. If the problem is not caused by workmanship or materials, or if the component is customer replaceable, you will be charged for a service person's travel expenses and labor, even though the product may be under warranty. The following items are considered customer replaceable: oven racks, light bulbs, control knobs which can be removed by pulling them off the control shaft. The heating elements in the rangetop can be replaced individually by an authorized servicer.

WHEN SERVICE IS REQUIRED

The dealer from whom you purchased the range can give you the name of your nearest Authorized Service Center. Help them give you prompt service by giving them:

1. An accurate description of the trouble.
2. Complete model, serial, and manufacturing numbers located on the oven frame below the oven door. Can be seen by slightly pulling out the storage drawer.
3. Proof of purchase (sales receipt on request)

Repair by an unauthorized servicer that results in subsequent failure will void the warranty. Warranty details are contained in the warranty certificate enclosed with this booklet. Keep an accurate record of any service calls: what was done, who serviced the range, and the date of service.

We have a vast network of Authorized Service Centers in the U.S., however, if you should have a service problem that is not resolved please

**Write: Consumer Affairs Department
Amana Refrigeration, Inc.
Amana, Iowa 52204**

For quicker service or for answers to questions concerning product usage, installation, and warranty, call:

**CONSUMER INFORMATION LINE
TOLL FREE 1-800-843-0304
(Monday through Friday 8 a.m. to 4:30 p.m., Central Time Zone)**

Asure[™]

**Rest assured against unexpected repair bills!
EXTENDED SERVICE PLAN**

We are pleased to offer an important opportunity for long-term service protection on your new appliance. The Asure Extended Service Plan is specially designed to supplement the strong warranty that already accompanies your appliance, and it combines with this standard warranty to provide budget protection coverage on your appliance for up to five full years, covering parts, labor and travel charges.

Your participating dealer has details or you can call or write us using the number or address listed above.

Part No. **36-308798-03-0**
Printed in U.S.A.

Amana
A **Raytheon** Company

©1993 Amana Refrigeration, Inc.
Amana, Iowa 52204

Free Manuals Download Website

<http://myh66.com>

<http://usermanuals.us>

<http://www.somanuals.com>

<http://www.4manuals.cc>

<http://www.manual-lib.com>

<http://www.404manual.com>

<http://www.luxmanual.com>

<http://aubethermostatmanual.com>

Golf course search by state

<http://golfingnear.com>

Email search by domain

<http://emailbydomain.com>

Auto manuals search

<http://auto.somanuals.com>

TV manuals search

<http://tv.somanuals.com>