



DEHUMIDIFIER



CONTENTS

Thank you	3
Safety Instructions	3
How it works	5
Placement	6
Operation	7
Emptying the water tank	8
Cleaning	9
Long term storage	9
Trouble shooting	10
Technical data	10

THANK YOU

Thank you for choosing this innovative Amcor dehumidifier. We suggest that you keep this manual in a safe place for future reference. It describes the many benefits and advanced features this unique product has to offer. Before you use it, you should carefully read these instructions to maximise this product's performance.

For over 50 years Amcor has specialised in complete indoor environmental control, manufacturing and marketing dehumidifiers, portable air conditioners, coolers, air purifiers, ionisers and aromatherapy scent diffusers. These world class products incorporate the latest technological developments.

SAFETY INSTRUCTIONS

- Remove all packaging materials from the unit, keep it away from babies and small children to avoid the danger of suffocation.
- Before inserting the plug make sure that the voltage is within the range indicated on the rating label on the unit.
- The dehumidifier is intended exclusively for the use for which it was created. Amcor is not responsible for any damage caused by improper use.
- The dehumidifier is safe, however as with other electrical appliances, use it with care.

IMPORTANT!

- The unit is designed for indoor operation.
- Rating: This unit must be connected to a 220-240 V / 50 Hz earthed outlet.
- The installation must be in accordance with regulations of the country where the unit is used.

If you are in any doubt about the electrical installation, have it checked and if necessary modified by a qualified electrician.

- Unplug when not in use. Do not unplug by pulling the cord.
- Do not operate this product with wet hands.
- Keep out of the reach of children.
- Do not clean the unit by spraying it or immersing it in water.
- Disconnect it from the mains before cleaning the unit or any of its components.
- Always unplug before changing the carbon filter.
- Do not connect the unit to an electrical outlet using an extension cord. If an outlet is not available, one should be installed by a licensed electrician.

- Never operate this appliance if it is damaged or if it has a damaged cord or plug.
- Do not lead the cord over sharp edges.
- A damaged supply cord should be replaced by the manufacturer, its service agent or a qualified person in order to avoid a hazard.
- Any service other than regular cleaning or replacing the carbon filter should be performed by an authorized service representative. Failure to do so could result in a loss of warranty.

The first time that you use the unit please ensure that it has been standing for 1 hours in an upright position before it is switched on.

IMPORTANT: The unit is not to be used in temperatures under 5 °C.

Do not use your dehumidifier under the following conditions:



If the power cable wires are frayed or cut



When small children may be left unattended

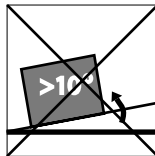

On a slope or uneven surface



Close to a heat source



This product is not made for DIY repair

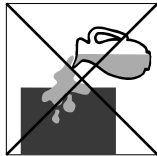

If there is a risk of liquid falling on the unit

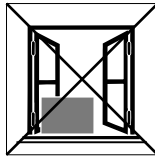

Inside unit exposed to the weather outdoors



In a permanent very humid environment

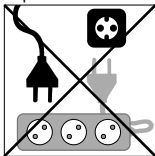

If an extension cord is needed to reach an outlet

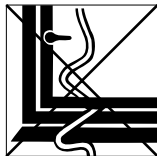

Where the power cable may be damaged



Where it may be damaged by chemicals

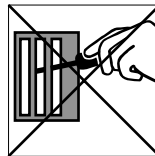

Where there is a risk of interference by foreign objects



Reminder:

Waste electrical products must not be disposed of with household waste.
This product should be taken to your local recycling centre for safe treatment.

HOW IT WORKS

Your Amcor dehumidifier draws air through two filters onto a refrigerated cold coil. As the air in the room passes over the cold surface, moisture condenses and collects into a removable water tank. The drier, slightly warmer air is then expelled through the air outlet with movable louvres on top of the unit into the room.

The dehumidifier controls the moisture level and protects your furniture, precious possessions and decor from the damaging effects of excessive moisture. Your dehumidifier is also great for drying the laundry, but not in permanent humid areas such as the bathroom!

When the water tank is full, a micro switch automatically stops the unit and an indicator light signals the need to empty the tank. If preferred a continuous drainage hose connected to the bottom of the unit can be used to drain the water.

SAVE ENERGY It takes less energy to warm dry air than damp humid air!

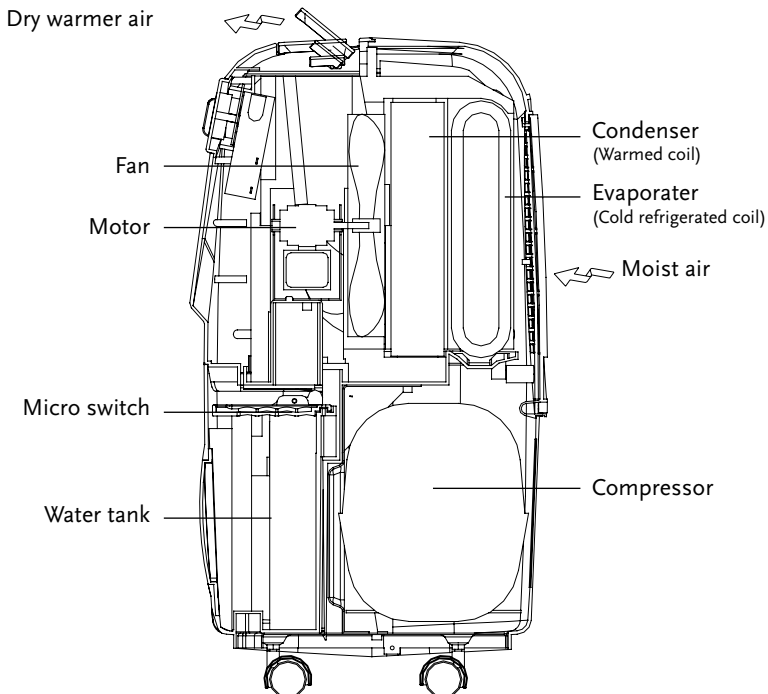

PLACEMENT

Your AMCOR dehumidifier will begin to protect your home from the harmful effects of excessive moisture as soon as it is turned on.

Excess moisture travels throughout your home, in the same way that cooking smells spread to every room in the house. For this reason, the dehumidifier should be positioned in a central and clear location so that it can draw this moist air towards it from all over the home. A warm hallway or landing is an excellent position for your dehumidifier. If possible, leave interior doors ajar to allow air circulation.

Alternatively, if you have a serious problem in one area you can begin by positioning the dehumidifier there and later moving it to a more central point.

For the most effective use, run your dehumidifier with external doors and windows kept closed when the dehumidifier is operating.

Please note the unit should not be placed directly against a radiator or other heat source.

When positioning your AMCOR dehumidifier, ensure that it is placed securely on a level surface clear of any obstacle that may limit the air movement.

Your AMCOR dehumidifier is fitted with 4 wheels for easy movement. Before you move the unit, switch it off and empty the water tank.

CONTROL PANEL AND OPERATION

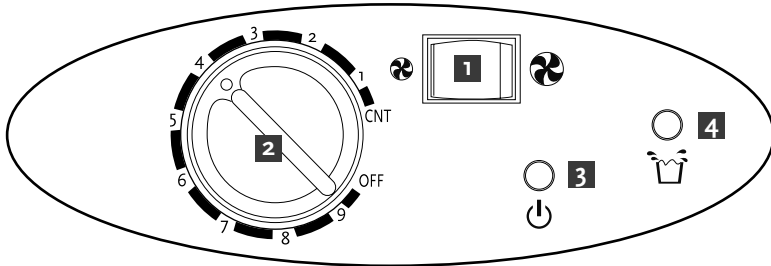

ON and humidity level control [2]

Turn the humidity control knob to the OFF position before connecting to the mains. Set the humidity controller to the required humidity level or fully clockwise to the maximum position for continuous working.

By rotating the knob clockwise the unit will switch off at a lower relative humidity, i.e. it will extract more.

OFF

To turn off the unit, turn the humidity controller fully anticlockwise to OFF. Indicator light [3] will go out.

Fan speed control [1]

This dehumidifier features a twin speed fan. To select required fan speed press fan speed switch as shown.

In normal conditions, set the speed to high . For quieter operation, set the speed to low .

Water container full indicator [4]

When the water container is full the unit will switch off and the indicator  will illuminate (see "Emptying the water tank" how to proceed).

Remarks:

1. The unit does not run when the set humidity level is higher than the relative humidity in the room.
2. To protect the compressor from possible damage, please wait three minutes after turning off the unit before switching back on again.
3. The working temperature is 5 - 35 °C.
4. When the unit runs the expelled air is warmer than the room air.
5. When the unit does not start (indicator light [3] is out), check if cable and electricity function as they should, wait for 10 minutes. If the unit then does not start, call for assistance.

EMPTYING THE WATER TANK

When the water tank is full, the unit will switch off automatically and the  indicator [4] will illuminate.

At this time, please empty the water tank as follows:

- Slowly slide out the tank squarely using the recess at the bottom of the water tank as shown.
- Holding the handle inside the container, pull it slightly up and then pull out gently for easy removal.
- Once emptied, gently push the water tank back into place checking the  indicator light is off.
If the tank is not in the correct position the indicator light will stay on.

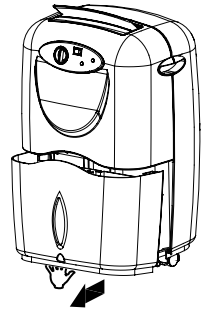

Continuous drainage

Optional: For the continuous drainage facility please refer to the following:

1. Remove the water cap from the tube beneath the unit.
* Please keep the rubber plug safely for future use.
2. Fit a hose with an inside diameter of 11 mm over the drainage spout.
3. Ensure the water will always drain away freely and the hose will remain in place.
4. If you no longer need to drain continuously, take off the water tube and replace the rubber plug. The water will then drain into the container.

Note: In very cold weather conditions, precautions should be taken to prevent the drainage hose from freezing.

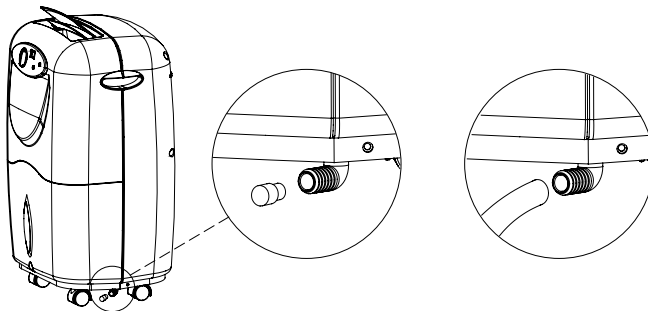

CLEANING

Always unplug the unit from the mains before carrying out any maintenance or cleaning the unit.

Cleaning the body

Only use a soft cloth to wipe the unit clean.

Do not use volatile chemicals, petrol, detergents, chemically treated cloths or other harmful cleansing solutions. These could all possibly damage the cabinet.

Cleaning the air filter

This dehumidifier is equipped with a washable anti-dust filter and an active carbon odour eating filter. These will capture most airborne pollutants like dust, smoke, animal dander, mould spores and pollen and absorb most unwanted stale odours to create a less irritating living environment for your enjoyment.

It is advisable to check the filters on a regular basis (at least monthly and after storage) and clean or change as necessary following the guidelines below.

1. Extract the filter holder.
2. Unclip the frame and remove the washable and carbon filters. Use warm water with a small amount of medium strength detergent to wash the filter and rinse under the cold water tap.
3. Make sure the filter is dry before replacing.
4. The black slim line active carbon filter can be vacuum cleaned only. *To fix the active carbon filter in position, please hook it onto the plastic frame as indicated.

* Replace however every 3-6 months.

Note: Do not expose the filter to sunlight or other sources of direct heat as this may cause the filter and frame to warp.

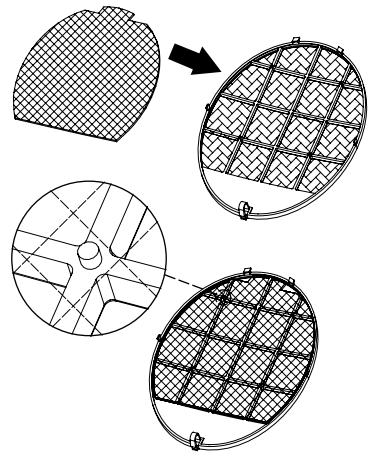

LONG TERM STORAGE

If the dehumidifier is not used for long periods of time, follow these steps:

- disconnect the unit and wrap the power cable.
- if used, empty the water container.
- clean the unit and filter, pack it in its original packaging or cover to protect against dust.
- store the unit in an upright position in a cool, dry place away from access by children.

TROUBLE SHOOTING

Never try to repair or dismantle the unit yourself. Before calling for assistance please check the points below.

The unit doesn't run.	Is the machine plugged in?
	Is the mains power supply on?
	Is the water tank full indicator on? (If so, the water tank is full or it isn't positioned properly).
The unit seems to extract little water.	Are too many windows or doors open?
	Is there something in the room producing lots of heat?
	Is the room cold – the colder the air the less moisture the unit will extract.
	Is the filter dirty?
The unit seems to do nothing.	Is the room humidity already quite low?
	Is the filter dirty?
	Is the air intake or outlet blocked?
	Is the room humidity already quite low?
Too noisy.	Is the room temperature below 5 °C? The fan may run without the compressor.
	Is the machine positioned unevenly so as to create vibration?
	Is the floor underneath the unit uneven or loose fitting?
The unit's fan doesn't seem to be revolving.	Is there any foreign body interfering with the unit?
	Is the filter blocked?
The continuous drainage is not working.	Does the hose have a downward slope throughout its entire length?
	Is there a kink or sharp bend in the hose?

TECHNICAL DATA

Model		QT 120
Power supply		220 - 240 V / 50 Hz
Power consumption (at 27 °C, 90% RH)	W	195
Moisture removal (at 32 °C, 90% RH)	L/24h	12
Refrigerant		R-134A
Refrigerant load	g	180
Working temperature	°C	5 - 35
Dimensions (W x D x H)	cm	33,7 x 28,6 x 53,5
Nett weight	kg	13
Due to our continuous R+D program, specifications may change without prior notice. For current specifications please refer to the rating label on your machine.		

Hong Kong

Amcors Ltd
Suite 2007, Tower 6, The Gateway,
Harbour City, 9 Canton Road,
Tsim Sha Tsui, Kowloon,
Hong Kong
Tel: +852 2997 6865
Fax: +852 2997 6091
Email: amcorhk@amcorgroup.com

United Kingdom

Amcors Ltd
9 Ryan Drive, West Cross Centre,
Great West Road, Brentford,
Middlesex, TW8 9ER,
United Kingdom
Tel: +44 20 8560 4141
Fax: +44 20 8232 8814
Email: amcoruk@amcorgroup.com

USA

Amcors Inc.
685A Gotham Parkway, Carlstadt,
New Jersey 07072,
United States of America
Tel: +1 201 460 8100
Fax: +1 201 460 9481
Email: amcorusa@amcorgroup.com

The Netherlands

Amcors B.V.
Anton Philipsweg 9-11,
1422 AL Uithoorn,
The Netherlands
Tel: +31 297 560 079
Fax: +31 297 523 062
Email: amcorex@amcorgroup.com

Israel

Amcors International Ltd
1 Sapir St.,
P.O. Box 120001,
Hertzelia Pituach,
Israel
Tel: +972 9 951 5351
Fax: +972 9 958 5650
Email: amcoril@amcorgroup.com

Singapore

Amcors Investments (Singapore) Pte Ltd
545 Orchard Road,
#13-02, Far East Shopping Centre,
Singapore 238882
Tel: +65 6297 8881
Fax: +65 6297 8891
Email: amcorsg@amcorgroup.com

China

Shan Xia Industrial Development Zone,
Heng Li Town, Dongguan City,
Guangdong Province, China

Plant One - Amcor (China) Ltd

Tel: +86 769 8372 1090
Fax: +86 769 8372 1790
Email: amcorcn@amcorgroup.com

Plant Two - Amcor Appliances Ltd

Tel: +86 769 8372 1970
Fax: +86 769 8372 1790
Email: amcorappl@amcorgroup.com



Free Manuals Download Website

<http://myh66.com>

<http://usermanuals.us>

<http://www.somanuals.com>

<http://www.4manuals.cc>

<http://www.manual-lib.com>

<http://www.404manual.com>

<http://www.luxmanual.com>

<http://aubethermostatmanual.com>

Golf course search by state

<http://golfingnear.com>

Email search by domain

<http://emailbydomain.com>

Auto manuals search

<http://auto.somanuals.com>

TV manuals search

<http://tv.somanuals.com>