

American Audio® Operating Instructions

CDS-1

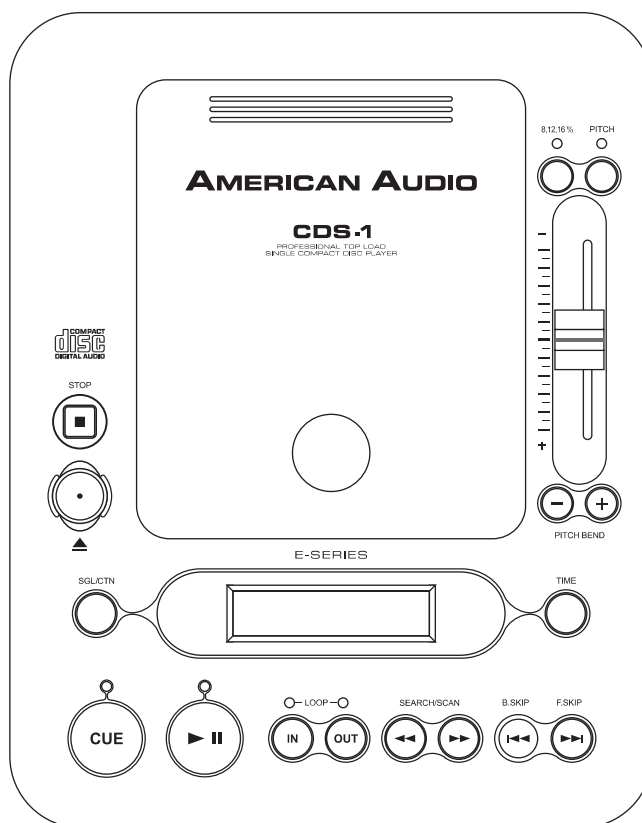

Featuring:



Q-Start



American Audio®
4295 Charter Street
Los Angeles Ca. 90058
Revised 11/05

CONTENTS

WARRANTY REGISTRATION.....	2
ELECTRICAL SAFETY PRECAUTIONS.....	3
ELECTRICAL PRECAUTIONS.....	4
PRODUCT INFORMATION	5
CUSTOMER SUPPORT.....	6
SET-UP.....	6
FEATURES.....	7
HANDLING COMPACT DISC.....	7
FUNCTIONS AND CONTROLS.....	8
LIQUID CRYSTAL DISPLAY.....	11
BASIC OPERATION	
LOADING DISC.....	12
SELECTING TRACKS.....	12
STARTING PLAYBACK.....	12
STOPPING PLAYBACK.....	13
FRAME SEARCH.....	13
SCANNING TROUGH TRACKS.....	14
ADJUSTING TIME DISPLAY.....	14
MAKING PITCH CHANGES	15
CREATING LOOPS.....	17
SINGLE/CONTINUOUS PLAYBACK.....	19
CUE PLAY.....	20
ADVANCED OPERATIONS	
Q-START.....	21
FLIP-FLOP.....	21
WARRANTY.....	22
SPECIFICATIONS.....	23

WARRANTY REGISTRATION

The CDS-1™ carries a one year (365 days) limited warranty. Please fill out the enclosed warranty card to validate your purchase. All returned service items whether under warranty or not, must be freight pre-paid and accompany a return authorization (R.A.) number. The R.A. number must be clearly written on the outside of the return package. A brief description of the problem as well as the R.A. number must also be written down on a piece of paper and included in the shipping container. If the unit is under warranty, you must provide a copy of your proof of purchase invoice. You may obtain a R.A. number by contacting customer support at (800) 322-6337.

ELECTRICAL SAFETY PRECAUTIONS

NOTE: This CD player uses a semiconductor laser. It is recommended for use in a room at the following temperature: 41°F - 95°F / 5°C - 35°C

CAUTION:

1. Handle the power supply cord carefully. Do not damage or deform; it may cause electric shock or malfunction when used. Hold plug attachment when removing from wall outlet. Do not pull on the cord.
2. To avoid electric shock, do not open the top cover when the unit is plugged in. If problems occur with the unit, call your local American Audio® dealer.
3. Do not place metal objects or spill liquid inside the CD player. Electric shock or malfunction may occur.

The serial and model number for this unit is located on the rear panel. Please write down the numbers here and retain for future reference.

Model No. _____

Serial No. _____

NOTE: This product satisfies FCC regulations when shielded cables and connectors are used to connect the unit to other equipment. To prevent electromagnetic interference with electrical appliances such as radios and televisions, use shielded cables and connectors for connections.

CAUTION:

USE OF CONTROLS OR ADJUSTMENTS OTHER THAN THOSE SPECIFIED HEREIN MAY RESULT IN HAZARDOUS RADIATION EXPOSURE

THE COMPACT DISC PLAYER SHOULD NOT BE ADJUSTED OR REPAIRED BY ANYONE EXCEPT PROPERLY QUALIFIED SERVICE PERSONNEL.

CAUTION: TO PREVENT ELECTRIC SHOCK DO NOT USE THIS (POLARIZED) PLUG WITH AN EXTENSION CORD, RECEPTACLE, OR OTHER OUTLET UNLESS THE BLADES CAN BE CAREFULLY INSERTED TO PREVENT BLADE EXPOSURE

ATTENTION: POUR PREVENIR LES CHOCS ELECTRIQUES NE PAS UTILISER CETTE FICHE POLARISEE AVEC UN PROLONGATEUR, UNE PRISE DE COURANT OU UNE AUTRE SORTIE DE COURANT, SAUF SI LES LAMES PEUVENT ETRE INSEREES A FOND SANS EN LAISSER AUCUNE PARTIE A DECOUVERT.

WARNING: TO PREVENT FIRE OR SHOCK HAZARD, DO NOT EXPOSE THIS UNIT TO WATER OR MOISTURE

This equipment has been tested and found to comply with the limits for a Class B digital device, pursuant to Part 15 of the FCC Rules. These limits are designed to provide reasonable protection against harmful interference in a residential installation. This equipment generates, uses, and can radiate radio frequency energy and, if not installed and used in accordance with the instructions, may cause harmful interference to radio communications. However, there is no guarantee that interference will not occur in a particular installation. If this equipment does cause harmful interference to radio or television reception, which can be determined by turning the equipment off and on, the user is encouraged to try to correct the interference by one or more of the following measures:

- Reorient or relocate the receiving antenna.
- Increase the separation between the equipment and receiver.
- Connect the unit into an electrical outlet on a circuit different from that to which the receiver is connected.
- Consult the dealer or an experienced radio/TV technician for help.

ELECTRICAL SAFETY PRECAUTIONS

ELECTRICAL PRECAUTIONS



The lightning flash with arrowhead symbol, within an equilateral triangle, is intended to alert the user to the presence of uninsulated "dangerous voltage" within the product's enclosure that may be of sufficient magnitude to constitute a risk of electric shock to persons.

CAUTION

RISK OF ELECTRIC SHOCK
DO NOT OPEN



CAUTION: TO REDUCE THE RISK OF ELECTRIC SHOCK, DO NOT REMOVE THE COVER (OR BACK). THERE ARE NO USER SERVICEABLE PARTS INSIDE. REFER SERVICE TO YOUR AUTHORIZED AMERICAN AUDIO® SERVICE TECHNICIAN.

The exclamation point within an equilateral triangle is intended to alert the user to the presence of important operating and maintenance (servicing) instructions in the literature accompanying the appliance.

IMPORTANT SAFETY INSTRUCTIONS

READ INSTRUCTIONS — All the safety and operating instructions should be read before the product is operated.

RETAIN INSTRUCTIONS — The safety and operating instructions should be retained for future reference.

HEED WARNINGS — All warnings on the product and in the operating instructions should be adhered to.

FOLLOW INSTRUCTIONS — All operating and use instructions should be followed.

CLEANING — The product should be cleaned only with a polishing cloth or a soft dry cloth. Never clean with furniture wax, benzene, insecticides or other volatile liquids since they may corrode the cabinet.

ATTACHMENTS — Do not use attachments not recommended by the product manufacturer as they may cause hazards.

WATER AND MOISTURE — Do not use this product near water — for example, near a bathtub, wash bowl, kitchen sink, or laundry tub; in a wet basement; or near a swimming pool; and the like.

ACCESSORIES — Do not place this product on an unstable cart, stand, tripod, bracket, or table. The product may fall, causing serious injury to a child or adult, and serious damage to the product. Use only with a cart, stand, tripod, bracket, or table recommended by the manufacturer, or sold with the product. Any mounting of the product should follow the manufacturer's instructions, and should use a mounting accessory recommended by the manufacturer.

CART — A product and cart combination should be moved with care. Quick stops, excessive force, and uneven surfaces may cause the product and cart combination to overturn.



VENTILATION — Slots and openings in the cabinet are provided for ventilation and to ensure reliable operation of the product and to protect it from overheating, and these openings must not be blocked or covered. The openings should never be blocked by placing the product on a bed, sofa, rug, or other similar surface. This product should not be placed in a built-in installation such as a bookcase or rack unless proper ventilation is provided or the manufacturer's instructions have been adhered to.

POWER SOURCES — This product should be operated only from the type of power source indicated on the marking label. If you are not sure of the type of power supply to your home, consult your product dealer or local power company.

LOCATION — The appliance should be installed in a stable location.

NONUSE PERIODS — The power cord of the appliance should be unplugged from the outlet when left unused for a long period of time.

GROUNDING OR POLARIZATION

- If this product is equipped with a polarized alternating current line plug (a plug having one blade wider than the other), it will fit into the outlet only one way. This is a safety feature. If you are unable to insert the plug fully into the outlet, try reversing the plug. If the plug should still fail to fit, contact your electrician to replace your obsolete outlet. Do not defeat the safety purpose of the polarized plug.

- If this product is equipped with a three-wire grounding type plug, a plug having a third (grounding) pin, it will only fit into a grounding type power outlet. This is a safety feature. If you are unable to insert the plug into the outlet, contact your electrician to replace your obsolete outlet. Do not defeat the safety purpose of the grounding type plug.

POWER-CORD PROTECTION - Power-supply cords should be routed so that they are not likely to be walked on or pinched by items placed upon or against them, paying particular attention to cords at plugs, convenience receptacles, and the point where they exit from the product.

OUTDOOR ANTENNA GROUNDING — If an outside antenna or cable system is connected to the product, be sure the antenna or cable system is grounded so as to provide some protection against voltage surges and built-up static charges. Article 810 of the National Electrical Code, ANSI/NFPA 70, provides information with regard to proper grounding of the mast and supporting structure, grounding of the lead-in wire to an antenna discharge unit, size of grounding conductors, location of antenna-discharge unit, connection to grounding electrodes, and requirements for the grounding electrode. See Figure A.

LIGHTNING — For added protection for this product during a lightning storm, or when it is left unattended and unused for long periods of time, unplug it from the wall outlet and disconnect the antenna or cable system. This will prevent damage to the product due to lightning and power-line surges.

POWER LINES — An outside antenna system should not be located in the vicinity of overhead power lines or other electric light or power circuits, or where it can fall into such power lines or circuits. When installing an outside antenna system, extreme care should be taken to keep from touching such power lines or circuits as contact with them might be fatal.

OVERLOADING — Do not overload wall outlets, extension cords, or integral convenience receptacles as this can result in a risk of fire or electric shock.

OBJECT AND LIQUID ENTRY - Never push objects of any kind into this product through openings as they may touch dangerous voltage points or short-out parts that could result in a fire or electric shock. Never spill liquid of any kind on the product.

SERVICING — Do not attempt to service this product yourself as opening or removing covers may expose you to dangerous voltage or other hazards. Refer all servicing to qualified service personnel.

DAMAGE REQUIRING SERVICE - Unplug this product from the wall outlet and refer servicing to qualified service personnel under the following conditions:

- When the power-supply cord or plug is damaged.
- If liquid has been spilled, or objects have fallen into the product.
- If the product has been exposed to rain or water.
- If the product does not operate normally by following the operating instructions. Adjust only those controls that are covered by the operating instructions as an improper adjustment of other controls may result in damage and will often require extensive work by a qualified technician to restore the product to its normal operation.
- If the product has been dropped or damaged in any way.
- When the product exhibits a distinct change in performance — this indicates a need for service.

REPLACEMENT PARTS — When replacement parts are required, be sure the service technician has used replacement parts specified by the manufacturer or have the same characteristics as the original part. Unauthorized substitutions may result in fire, electric shock, or other hazards.

SAFETY CHECK - Upon completion of any service or repairs to this product, ask the service technician to perform safety checks to determine that the product is in proper operating condition.

WALL OR CEILING MOUNTING — The product should not be mounted to a wall or ceiling.

HEAT — The product should be situated away from heat sources such as radiators, heat registers, stoves, or other products (including amplifiers) that produce heat.

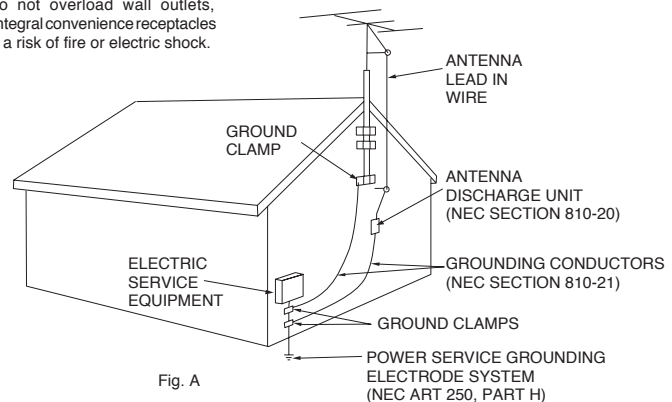

Fig. A

NEC — NATIONAL ELECTRICAL CODE

PRODUCT INFORMATION

1. Heat - The CD player should be situated away from heat sources such as radiators, heat registers, stoves, or other appliances (including amplifiers) that produce heat.
2. Do not let insecticides, benzene, or thinner come in contact with the surface of the unit.
3. Never disassemble or modify your unit in any way, doing so will void your manufacturer's warranty.
4. Never plug this unit in to a dimmer pack
5. Do not attempt to operate this unit if it becomes damaged in any way.
6. This unit is intended for indoor use only, use of this product outdoors voids all warranties.
7. Always mount this unit in safe and stable matter.
8. Disconnect from main power before making any type of connection.
9. Cleaning -
 - The CD Player should be cleaned only as recommended by the manufacturer. Use a soft cloth to wipe down the outside of the unit. For stubborn stains moisten a soft cloth with glass cleaner or other mild detergent to wipe away any stains. Use a soft cloth to wipe any residual cleaner. Never use volatile cleaners such as benzene, solvent, or thinner to clean your unit, these cleaners will damage the unit's surface.
 - Cleaning the pick-up lens - The pick-up lens should not become dirty under normal use. If the lens does become dirty, contact American Audio Technical Support for further instructions. Third party lens cleaners are available but not highly recommended. Use of some of these cleaners may damage the pick-up lens, be sure to follow extreme caution when using these types of cleaners.

Introduction

Thank you for purchasing the CDS-1 by American Audio®. This unit has been thoroughly tested and has been shipped in perfect operating condition. Carefully check the shipping carton for damage that may have occurred during shipping. If the carton appears to be damaged, carefully inspect your unit for any damage. Be sure all accessories needed to operate the unit have arrived intact. In the event damage has been found or parts are missing, please contact our toll free customer support number for further instructions. Please do not return the unit to your dealer without first contacting customer support at the number listed on the next page.

LINE VOLTAGE SELECTION

- The desired voltage may be set with the VOLTAGE SELECTOR switch on the rear panel (using a flat head screw driver).
- Do not force the VOLTAGE SELECTOR switch as this may cause damage
- If the VOLTAGE SELECTOR switch does not move smoothly, please contact a qualified service technician.

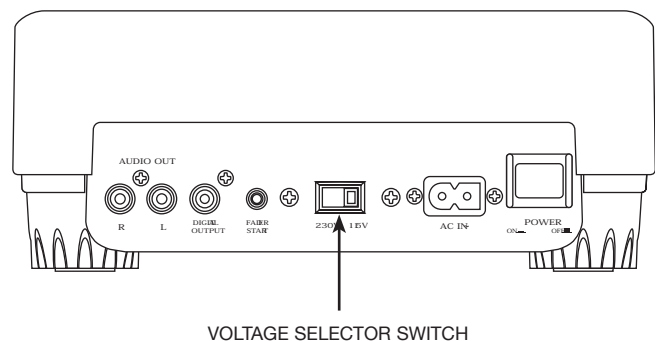

CUSTOMER SERVICE

Customer Support: American Audio® provides a toll free customer support line, to provide set up help and to answer any question should you encounter problems during your set up or initial operation. You may also visit us on the web at www.AmericanAudio.us for any comments or suggestions. For service related issue please contact American Audio®. Service Hours are Monday through Friday 9:00 a.m. to 5:00 p.m. Pacific Standard Time.

Voice: (800) 322-6337
Fax: (323) 582-2610
E-mail: support@AmericanAudio.us

To purchase parts online visit <http://parts.americandj.com>

Warning! To prevent or reduce the risk of electrical shock or fire, do not expose this unit to rain or moisture.

Caution! There are no user serviceable parts inside this unit. Do not attempt any repairs yourself, doing so will void your manufactures warranty. In the unlikely event your unit may require service please contact customer support. Please do not return to your dealer without first contacting customer support.

SET-UP

1. Checking the Contents:

Be sure your CDS-1™ was shipped with the following:

- | | |
|-----------------------------------|---|
| 1) CDS-1™ Professional CD player. | 1) Operating instructions (this booklet). |
| 1) One dual stereo RCA cable. | 1) One male to male 1/8" mini plug. |
| 1) Warranty card. | |

2. Installing the Units

- 1) Place your unit on a flat surface or mount it in a secure case.
- 2) Be sure the player is mounted in a well ventilated area where it will not be exposed to direct sunlight, high temperatures, or high humidity.
- 3) Try to place the unit as far as possible from TVs and tuners, as the unit may cause undesirable interference.

3. Connections

- 1) Be sure main power is connected last to prevent any electrical damage.
- 2) AUDIO CONNECTIONS: Use the included RCA cable to connect the CDS-1™ outputs to the line inputs of a mixer. Never connect a CD player's output to a mixers "phono" inputs.
- 3) CONTROL JACK CONNECTIONS: Use the supplied 1/8" mini plug cable to connect your CDS-1™ to a mini jack connection (A or B) on a compatible American Audio "Fader Q Start" mixer. (This will enable the Fader "Q" Start function - See "Q" start control page 7)

CAUTION: Be sure to use the supplied control cables. Using different types of cables may result in unit damage. To avoid server unit damage, be sure main power is off when connecting the control cables.

CAUTION:

- The player will work normally when the main unit is mounted with the front panel within 15 degrees of the vertical plane. If the unit is tilted excessively, discs may not be loaded or unloaded properly. (Figure 1)

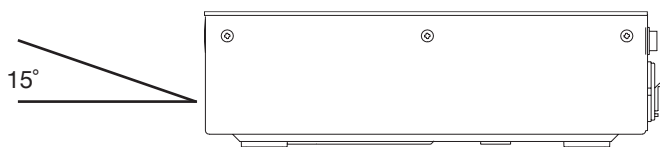

Figure 1

CAUTION:

- The LCD is designed to be clearly visible within the angles shown in Figure 2. Mount the control unit so that the visual angle is within this range.

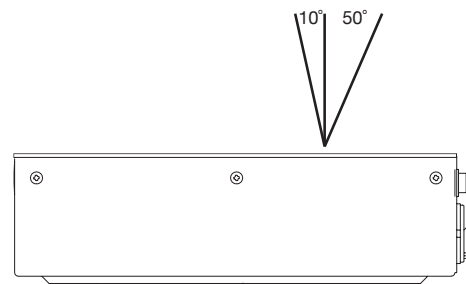

Figure 2

MAIN FEATURES

- 8 times over sampling 1 bit D/A converter
- Selectable Time Display
- Fader “Q” Start Control **(a)**
- Sleep Mode **(e)**
- Selectable Pitch: +/-8%, +/-12% or +/-16%
- Pitch Display
- Real-Time Cue
- Durable Polyurethane Case
- Large bright LCD Screen can be viewed from wide angles.
- Instant Start within 10 msec (sound is produced immediately when the PLAY button is pressed)
- Auto cue Function (Sensitive to -48dB)
- S/PDIF Digital Audio RCA Coaxial Output
- Flip-Flop (Relay Playback) **(c)**
- Memory Backup, Defaults to last setting **(f)**
- Loop
- Top Loading Transport System
- 4 Different Speed Scans
- Selectable Voltage
- Single/Continuous/Repeat Play Modes
- 1/75 Frame Search

(a) FADER “Q” START CONTROL: This feature is used in conjunction with American Audio® mixers that also feature “Fader Q Start” control. For best results use this feature with two CDS-1 players. By moving the mixer’s crossfader from left to right you can start and pause your CDS-1's playback functions. For Example, when using two CDS-1 units and a Fader “Q” Start mixer, if your mixer’s crossfader is all the way to the left (player one is playing, player two is in cue or pause mode), and you move the fader at least 20% to the right, player two will begin to play and player one will return to cue mode. When the crossfader is to the right, and you move it 20% to the left, player one will begin to play and player two will return to its’ cue point. You can create great effects similar to scratching with this feature. “Q” Start control is easy to use and mastering this feature will help you create amazing effects with your music.

(b) FLIP-FLOP: This feature is used in conjunction with American Audio® mixers that also feature Fader “Q” Start. For FLIP-FLOP results you must use two CDS-1 players. Connect your CDS-1’s as described in the set-up section of this manual. This feature will start the next player once one player has ended. For example, if player one is playing a disc and it ends, player two will instantly begin to play. You may set FLIP-FLOP to play track to track or disc to disc. For more information on this feature, see FLIP-FLOP™ on page 23.

COMPACT DISCS

1. PRECAUTIONS ON HANDLING COMPACT DISCS

Compact disc are constructed of the same types of plastic record are. To avoid severe damage to you valuable disc please observe the following guide lines. Following the these guide lines will ensure long disc life.

- Do not allow fingerprints, oil or dust to get on the surface of the disc. If the disc is dirty, wipe it off with a soft dry cloth.
- Do not use benzene, thinner, water, record spray, electrostatic-proof chemicals, or silicone-treated cloths to clean discs.
- Always handle discs carefully to prevent damaging the surface; in particular when removing a disc from its case.
- Do not bend the disc.
- Do not apply heat.
- Do not enlarge the hole in the center of the disc.
- Do not write on the label (printed side) with a hard tipped implement such as a pencil or ball point pen.
- Condensation will form if a disc is brought into a warm area from a colder one, such as outdoors in winter. Do not attempt to dry the disc with a hair dryer, etc.

2. PRECAUTION ON STORAGE

- After playing a disc, always unload it from the unit.
- Always store the compact disc in the jewel case, protecting from dirt or damage.
- Do not place discs in the following areas:
 - a) Areas exposed to direct sunlight for a considerable time.
 - b) Areas subject to accumulation of dust or high humidity.
 - c) Areas affected by heat from indoor heaters, etc.

GENERAL FUNCTIONS AND CONTROLS

Figure 3

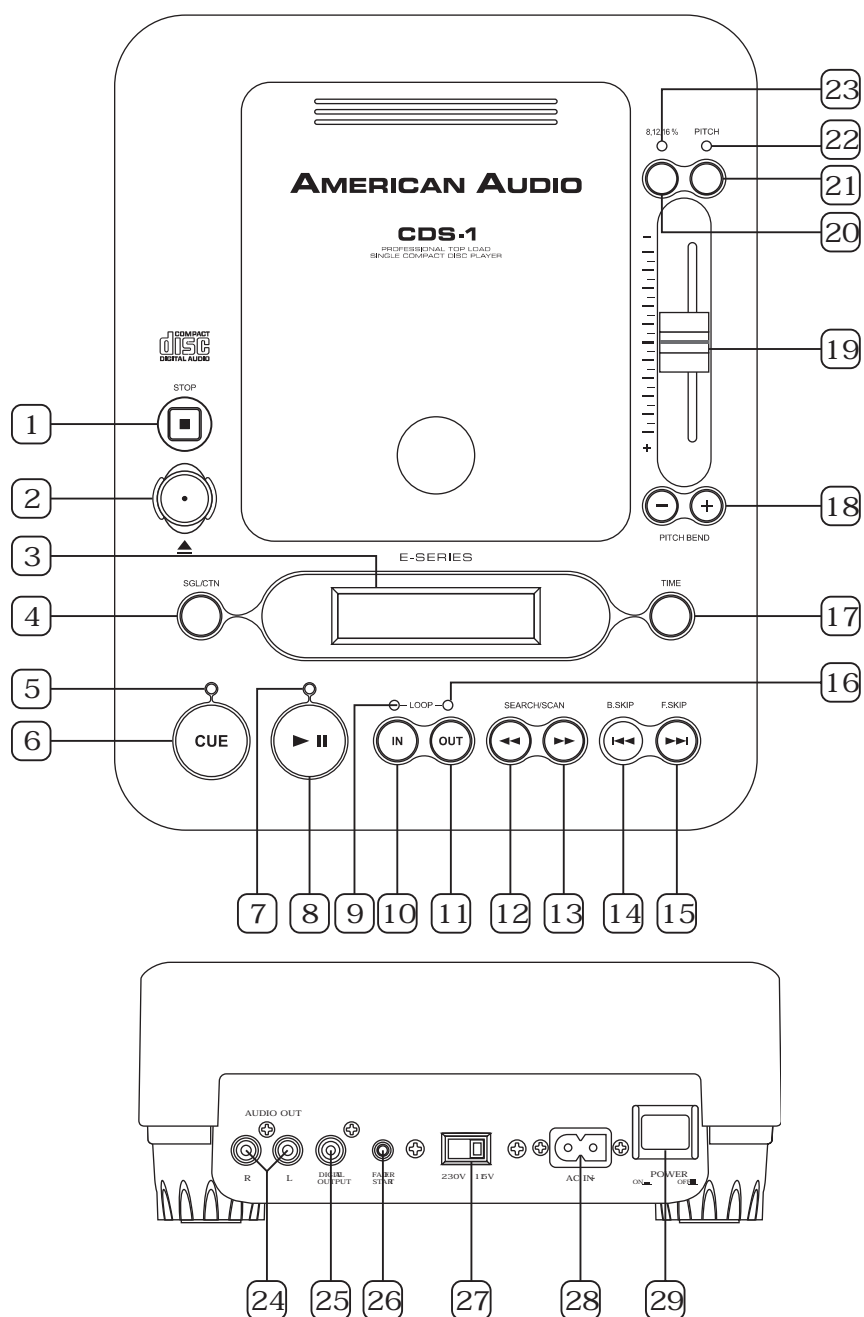

A. TOP UNIT CONTROLS (FIGURE 3)

1. STOP - The stop button is used to stop CD playback. Never open the transport door without stopping playback first.

2. OPEN (Transport Tray Open) - This button is used to open the disc transport tray door. **NOTE:** When a disc is loaded, the tray will not open unless the unit is in pause or cue mode.

3. LIQUID CRYSTAL DISPLAY (LCD) - This high quality LCD Indicates all the functions (play,

pause, etc...), as they occur. This display is view-able at several comfortable angles as described on page 11. The LCD will be described in the next section.

4. SGL/CTN - This button changes the play mode between Single and Continuous. In single mode the unit will play a single track and return to cue mode. In continuous mode the unit continues to play track by track and returns to cue mode after all tracks have played. This function

GENERAL FUNCTIONS AND CONTROLS (Cont.)

also operates in *FLIP FLOP* modes. When using two units in Flip-Flop mode, each unit may be set up to run in either single or continuous. In single mode a unit will play a single track and jump to the next unit. If the next unit is in continuous mode, that unit will play all tracks and jump back to next unit, and so on.

5. CUE LED - The red CUE LED will glow when the unit is in cue mode The LED will also flash every time a new CUE POINT is set.

6. CUE - Pressing the *CUE* button during playback immediately pauses playback and returns the track to the last set cue point (see setting a CUE POINT, page 14). The CUE button can be held down to momentarily play the CD. When you release the CUE button it instantly returns to the last set CUE POINT.

7. PLAY/PAUSE LED - While in play mode the green play LED will glow, and while in pause mode the green play LED will flash.

8. PLAY/PAUSE BUTTON - Each press of the *PLAY/PAUSE BUTTON* causes the operation to change from play to pause or from pause to play.

9. LOOP IN LED - This LED will flash each time the loop "IN" button is pressed indicated the cue point or loop starting point has been set.

10. LOOP IN BUTTON - "CUE ON THE FLY" - This button allows you to set a CUE POINT (see CUE POINT page 14) without music interruption ("on the fly"). This button also sets the starting point of a loop (see LOOP on page 17).

11. OUT - This button serves three functions. This button is used to set the a loops ending point, to exit a loop once engaged, or restart a loop once it has been exited. For more information, see looping on page 17.

12. ◀◀ SEARCH/SCAN BUTTON - This button is user to reverse scan or fast-reverse a track. Holding down the button for a prolonged amount of time will increase the scanning speed. Tapping the button is the preferred method for locating a specific cue point.

13. ▶▶ SEARCH/SCAN BUTTON - This button is user to forward scan or fast-forward a track. Holding down the button for a prolonged amount of time will increase the scanning speed. Tapping the button is the preferred method for locating a specific cue point.

14. |◀◀ TRACK BUTTON - This buttons is used to select a track. Tapping this button will back-skip to the previous track, holding down this button will rapidly back-skip through the tracks on a CD.

15. ▶▶| TRACK BUTTON - This buttons is used to select your desired track. Tapping this button will forward skip to the next track, holding down this button will rapidly forward skip through the tracks on your CD.

16. LOOP OUT LED - This LED will flash each time the loop "OUT" button is pressed indicated the cue point or loop starting point has been set.

17. TIME - The TIME button is used to changed the displayed time values. Time can be displayed as elapsed track time, remaining track time, and total disc remaining time. See page 14 for more information.

18. (+) & (-) PITCH BEND -

A. (+) PITCH BEND - The (+) pitch bend function creates a momentary "BUMP" in the CD's pitch speed (Beats per minute - BPM) when the *PITCH (21)* function is activated. This functions allows the beats between two CD's or any other music source to match. This is a momentary function. When the button is depressed the pitch speed will automatically return to *PITCH SLIDER'S (19)* selected pitch. Holding down this button down yields a maximum of +16% pitch. Be sure to remember that this function is a momentary pitch adjustment, for a more precise adjustment use the *PITCH SLIDER'S (19)* to match the BPM's with another playing music source.

B. (-) PITCH BEND BUTTON - The (-) pitch bend function creates a momentary "Slow Down" in the CD's pitch speed (Beats per minute - BPM) when the *PITCH (21)* function is acti-

GENERAL FUNCTIONS AND CONTROLS (Cont.)

vated. This function allows the beats between two CD's or any other music source to match. This is a momentary function. When the button is depressed the pitch speed will automatically return to *PITCH SLIDER'S (19)* selected pitch. Holding down this button down yields a maximum of -16% pitch. Be sure to remember that this function is a momentary pitch adjustment, for a more precise adjustment use the *PITCH SLIDER'S (19)* to match the BPM's with another playing music source.

19. PITCH SLIDER - This slider is used to adjust the playback pitch percentage when the *PITCH (21)* function is activated. The slider is a set adjustment and will remain set until the pitch slider is moved or the *PITCH (21)* function has been turned off. This adjustment can be made with or without a CD in the drive. The pitch adjustment will remain even if a disc has been removed, and will reflect on any other disc loaded into the unit. That is to say, if you set a +2% pitch on one disc, remove that disc and insert another, that disc too will have a +2% pitch. The amount of pitch being applied will be displayed in the *LCD (3)*. Use this slider to match the BPM's of this unit to that of another music source. By changing the pitch of one disc with respect to the other in this way, the beats can be matched.

20. PITCH SELECT - This button changes the pitch value. The pitch percentage can be changed between 8%, 12%, and 16%. 8% yields the least amount of pitch manipulation and 16% will yield the most amount of pitch manipulation. To adjust to the different values tap this button. The LED above this button will indicate which pitch percentage mode is activated. See *PITCH LED (23)*. The pitch values will immediately reflect the amount of pitch being applied to a music source in the CD drive. The pitch value is adjusted by sliding the *PITCH SLIDER (19)* up and down.

21. PITCH BUTTON - This button is used to turn the pitch function on and off. The pitch functions of the *PITCH SLIDER (19)*, and *PITCH BEND BUTTONS (18)* will not function without this function being activated. The pitch percentage value

can be changed from (+/- 8%), (+/- 12%) or (+/- 16%). The *PITCH SELECT LED (23)* will indicate the maximum pitch value.

22. PITCH LED - This red LED will glow when the pitch function is active

23. PITCH SELECT LED - This LED serves as a visual reminder of the selected pitch percentage mode. A flashing red LED will indicate 8% pitch manipulation, a solid glowing red LED will indicate 16% pitch manipulation, and when the LED is off 12% pitch manipulation will be applied to the *PITCH SLIDER (19)*.

24. AUDIO OUT R & L - These jacks send a left and right analog mono output signal. Use these jacks to send standard audio to a mixer or receiver.

25. DIGITAL OUT - This jack sends a digital stereo out signal. Use this connection to create near perfect copies of your disc to a Mini disc, CD-R, or any other recording device with a digital input.

26. CONTROL - These control jacks are only used for the "Q" function. Only use these jacks in conjunction with a compatible "Q" series American Audio® mixer or CD unit. Connect the supplied mini-plug from the *CONTROL* jack on the rear of your unit to the control jack on a compatible mixer or CD unit.

27. VOLTAGE SELECTOR - Because power supplies vary from location to location a voltage selector switch has been incorporated in the unit's design. This switch can select a voltage input of 120v or 220v to accommodate the two major power source. Always be sure to disconnect the power plug before changing the voltage.

28. POWER CONNECTOR - This is the main power connection. Only use the supplied polarized power cord. Use of any other power may result in severe damage to the unit. Be sure the local power matches the unit's required power.

29. POWER SWITCH - This switch controls the unit's main power.

LIQUID CRYSTAL DISPLAY (LCD)

LCD DISPLAY

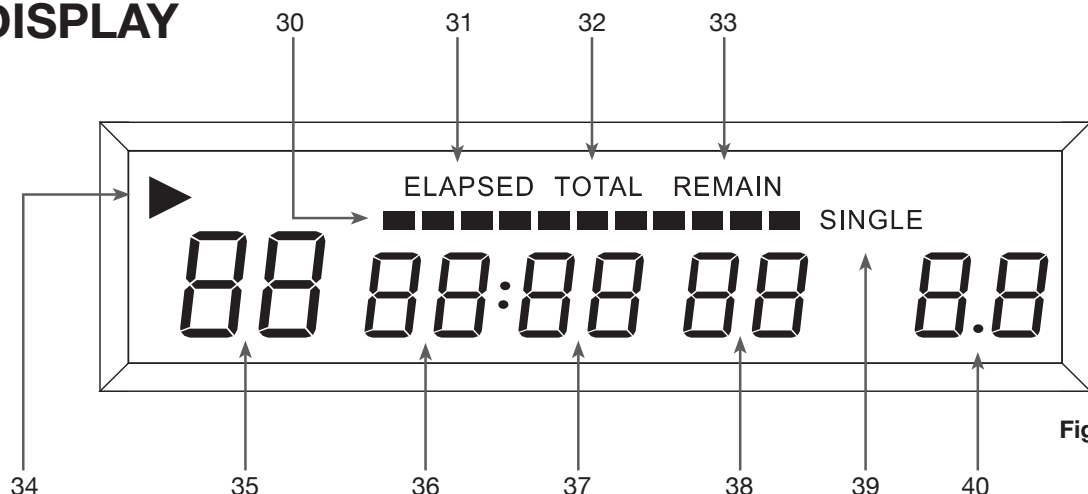

Figure 4

B. LCD DISPLAY (FIGURE 6)

30. TIME BAR INDICATOR - This bar visually details the time defined in the *TIME METER* (36, 37, & 38). As with the *TIME METER* (36, 37, & 38), this bar is also dependent on the selected time function (*TOTAL REMAIN* (32), *REMAIN* (33) OR *ELAPSE* (31). This bar will begin to flash when 15 seconds of a track remain and will begin to rapidly flash when three seconds of a track remain. The flashing bar is a great visual reminder a track is about to end. The flashing bar will function regardless of which time mode the unit is in.

31. ELAPSE INDICATOR - This indicator is in direct reference to the *TIME METER* (36, 37, & 38). When the *ELAPSE* indicator is displayed in the LCD, the time defined will refer to a single track's elapsed time. The time mode is changed by the tapping on the *TIME button* (17).

32. TOTAL REMAIN INDICATOR - This indicator is in direct reference to the *TIME METER* (36, 37, & 38). When the *TOTAL REMAIN* indicator is displayed in the LCD, the time defined will refer to a disc's total remaining time. The time mode is changed by tapping on *TIME button* (17).

33. REMAIN INDICATOR - This indicator is in direct reference to the *TIME METER* (36, 37, & 38). When the *REMAIN* indicator is displayed in the LCD, the time defined will refer to a single track's remaining time. The time mode is changed by tapping on *TIME button* (17).

34. PLAY INDICATOR - This indicator will glow when the unit is in play mode.

35. TRACK INDICATOR - This double digit indicator details a current track. The number displayed in the track indicator is a direct reference to a track being selected for programming or a track in play, pause, or cue mode.

36. MINUTES METER - This meter will display the elapse, total, or remaining time in minutes. The display time will be indirect reference to the current time mode.

37. SECONDS METER - This meter will display the elapse, total, or remaining time in seconds. The display time will be indirect reference to the current time mode.

38. FRAME METER - This meter will display the elapse, total, or frames. The displayed frames will be indirect reference to the current time mode.

39. SINGLE INDICATOR - This indicates the unit is in single play mode, the unit will play a single and return to CUE mode. If the single indicator is not displayed the unit is in continuous mode. In continuous mode the drive will play through all the tracks on the disc. Once all the tracks have ended the unit will return to cue mode.

40. PITCH METER - This meter displays the pitch percentage being applied to playback by the *PITCH SLIDER* (21). If the meter read zero regardless of the *PITCH SLIDER'S* (21) position, the *PITCH* (27) function is not activated.

BASIC OPERATIONS

1. OPENING THE DISC TRAY/LOADING DISCS

Caution: Never open the tray door when a disk is spinning - Always stop playback before opening the tray door. Press the OPEN BUTTON (2) to open the disc tray.

2. LOADING DISCS

The CDS-1 can play both 3 inch (8 cm) and 5 inch (12 cm) compact discs (CD's). Odd shaped and oval CD's are not compatible. When loading a CD into the unit always hold the disc by its' edges and place it in the disc tray. Never touch the signal surface (the glossy side).

CAUTION:

- NEVER insert any foreign objects in the disc tray.
- NEVER attempt to insert more than one disc in the disc tray at a time. Doing so may result in severe damage to the unit.

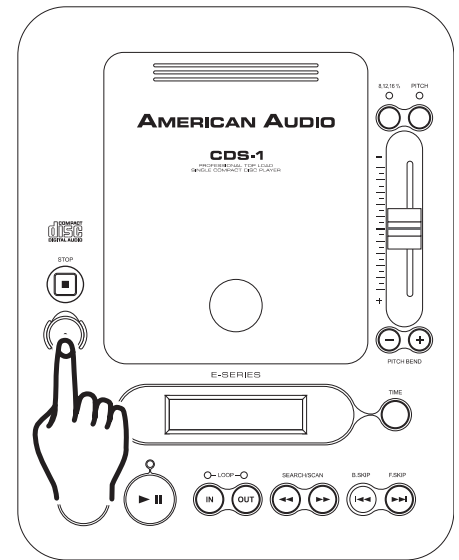

Figure 4



Figure 5

3. SELECTING TRACKS

Select a desired track by using either of the two *TRACK BUTTONS* (14 & 15). Tapping the *TRACK BUTTONS* (14 & 15) once will select either a higher or lower track. You may hold down the *TRACK BUTTONS* (14 & 15) to change tracks continuously at a higher speed. If you are using the *TRACK BUTTONS* (14 & 15) to select a new track during playback (a track already playing) the new track you selected will immediately begin playback as soon as the search operation is completed.

4. STARTING PLAYBACK

Insert an audio CD as describe above (loading discs). Pressing the *PLAY/PAUSE BUTTON* (8) with an audio CD inserted will immediately start playback. The *PLAY INDICATORS* (7 & 34) will glow as soon as playback begins. The point at which playback starts (cue point) will automatically be stored in the memory as the cue point. The unit will return to this cue point (the point at which playback started) when the *CUE BUTTON* (6) is pressed.

AUTO CUE

"Cueing" is the action of preparing for playback. When the unit is in cue mode the *CUE INDICATOR* (5) will glow. The unit is designed to automatically cue at the first audible signal on of a disc when a disc is inserted. If a track is selected before a disc is inserted, the unit will automatically cue to the first audible signal for the selected track.

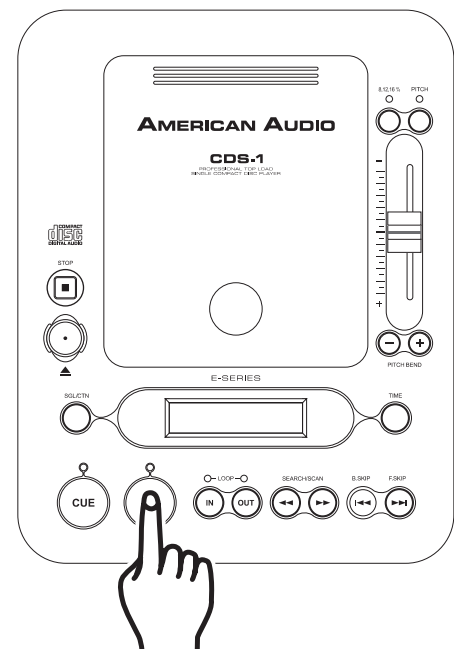

Figure 6

BASIC OPERATIONS

5. STOPPING PLAYBACK

Stopping playback will stop the drive mechanism allowing you to safely remove the CD from the transport drive. Pressing the *STOP BUTTON (1)* during any function will immediately stop the unit.

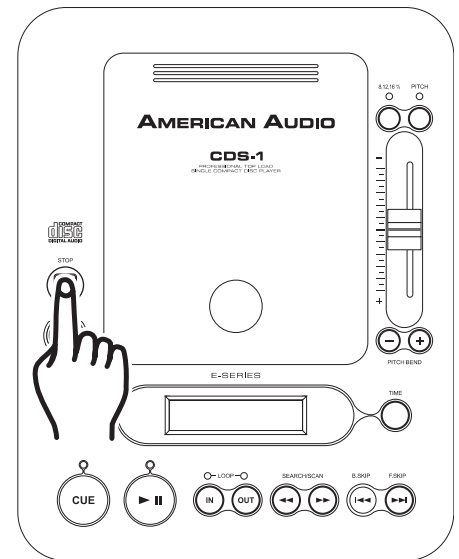

Figure 7

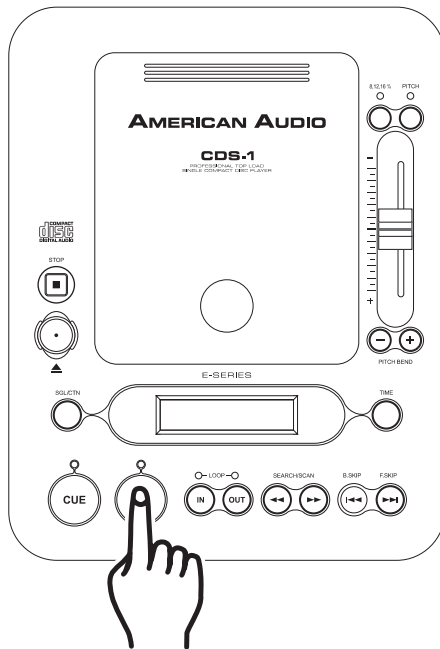

Figure 8

6. PAUSING

Pausing temporarily stops playback but does not stop the drive mechanism. Pressing the *PLAY/PAUSE BUTTON (8)* changes the operating mode between play and pause. The *PAUSE INDICATOR (7 & 34)* will glow when pause mode is activated or when a track is in cue mode.

7. FRAME SEARCH/SETTING CUE POINTS

This feature allows you to search through a track to set a cue or the beginning of a loop point. To use the search function you must first be in Pause or Cue mode. Once you are in Pause or Cue mode, use your finger to tap on either the *FORWARD SEARCH/SCAN BUTTON (13)* or the *REVERSE SEARCH/SCAN BUTTON (12)* depending on which direction you want to search (figure 9). Holding down on the button will increase the speed the search function will scan. Once you reach your desired starting point you can set a cue (starting) point by pressing the *PLAY/PAUSE BUTTON (19)* as in figure 9. Pressing the *CUE BUTTON (6)* will return the disc to the cue point just set.

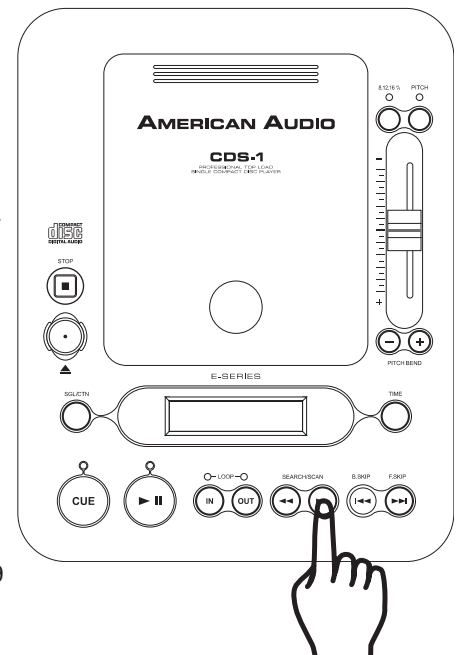
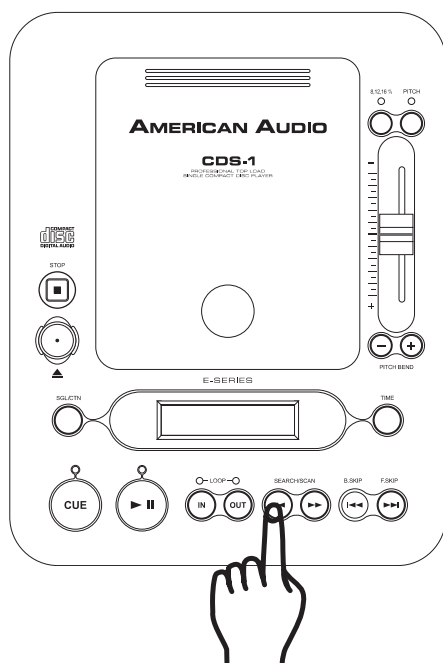

Figure 9

BASIC OPERATIONS (CONT.)



8. SCANNING (FAST FORWARD / FAST REVERSE)

This function gives you a fast search through a disk or track. For faster scanning speeds hold down either the *FORWARD SEARCH/SCAN BUTTON (13)* or the *REVERSE SEARCH/SCAN BUTTON (12)* depending on which direction you want to search. You can scan in 3 different forward and 3 different reverse speeds depending on how long the buttons are held down.

Figure 10

9. CHANGING THE TIME DISPLAY (31, 32, & 33)/TIME BAR (30):

The time may be displayed in three different modes; *Elapsed, Remain, and Total Remain*. During normal playback, pressing the *TIME BUTTON (17)* as in figure 11, will change the time display information (31, 32, 33, & 30) in the LCD. The following is a break down of the time settings and their definitions:

- 1) **ELAPSED** (31) - This details the time in the LCD (36, 37, & 38) as the current tracks' elapsed running time. The elapsed function only details a tracks elapsed time and not the entire disc.
- 2) **REMAIN** (33) - This details the time in the LCD (36, 37, & 38) as the current tracks' remaining running time.
- 3) **TOTAL REMAIN** (32) - This details the time in the LCD (36, 37, & 38) as the total disc remaining time.

TIME BAR INDICATOR - The time bar in the LCD visually details the time defined in the *TIME METER* (36, 37, & 38). This bar is also dependent on the selected time function (*TOTAL REMAIN* (32), *REMAIN* (33) or *ELAPSE* (31)). This bar will begin to flash when 15 seconds of a track remain and will begin to rapidly flash when three seconds of a track remain. The flashing bar is a great visual reminder a track is about to end. The flashing bar will function regardless of which time mode the unit is in.



Figure 11

BASIC OPERATIONS (CONT.)

10. PITCH ADJUSTMENTS:

This function will increase or decrease a tracks playback speed or "PITCH," this is not a momentary change as in "PITCH BENDING" (see page 16). The maximum pitch bend percentage allowed is +/-16%. The *PITCH SLIDER* (19) is used to decrease or increase the playback pitch. If the slider is move up (towards the top of the unit) the pitch will decrease, if the slider is moved down (towards the bottom of the unit) the pitch will increase. The *PITCH SLIDER* (19) adjustment can be changed to range from +/-8%, +/-12%, or +/-16% (See changing "PITCH SLIDER PERCENTAGE RANGE" figure 14/page 16). The pitch adjustments will effect playback, reverse playback, and loops.

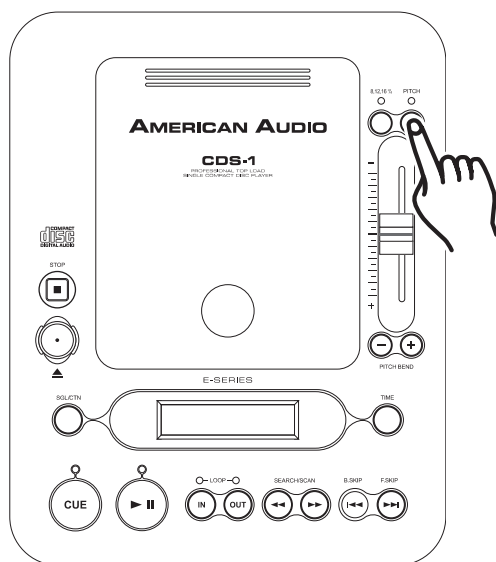

Figure 12

Activating the Pitch Slider (19): To activate the *PITCH SLIDER* (19), turn the pitch function on. Press the *PITCH BUTTON* (21) to turn on the pitch function, when the pitch function is activated the *PITCH LED* (22) will begin to glow. If the pitch function is not activated neither the *PITCH SLIDER* (19) nor the *PITCH BEND BUTTONS* (18) will not function.

Using the Pitch Slider (19): To use the *PITCH SLIDER* (19) slide the slider up and down. Down will increase the pitch and up will decrease the pitch. The *PITCH PERCENTAGE INDICATOR* (40) in the LCD (3) will detail the amount of pitch being applied to the track. When the slider is in the center position, zero pitch is being applied to the track and the *PITCH PERCENTAGE INDICATOR* (40) will read zero.

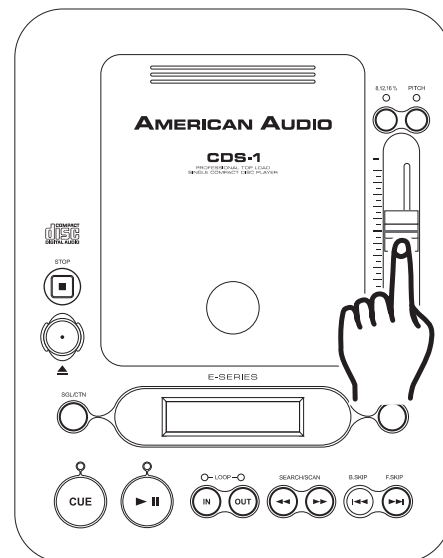

Figure 13

BASIC OPERATIONS (CONT.)

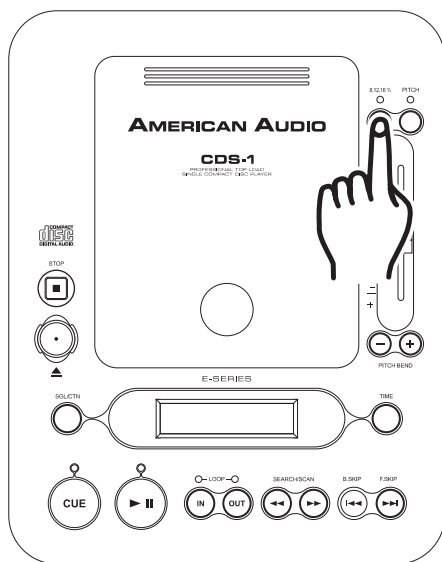

Figure 14

Adjusting the Pitch Slider's Range (19): You may change the *PITCH SLIDER'S* (19) operating range. To change the operating range be sure the pitch function is turned on, see figure 12 on the previous page. The pitch percentage can be changed between +/-8%, +/-12%, and +/-16%. +/-8% will allow the least amount of pitch manipulation and +/-16% will allow the most amount of pitch manipulation. To adjust to the different values tap the *P.S. BUTTON* (23). The *Pitch Select LED* (23) will indicated the current pitch level. Flashing red for +/-8%, off +/-12%, or glowing solid red for +/-16%. Note, the pitch function must be activated for a LED reading.

11. PITCH BEND:

This function will momentarily increase or decrease a tracks playback speed. Use the (-) & (+) *PITCH BENTONS* (18) for this function. The maximum pitch bend percentage allowed is +/- 16%. The pitch bend function will work in conjunction with the *PITCH SLIDER* (19) pitch setting. For example, if the *PITCH SLIDER* (19) is set to a 2% pitch gain the pitch bending process will begin at 2% and will continue to the maximum of -/+16% and then return to the original 2% pitch when the button is released.

PITCH BEND BUTTONS (18):

The (+) *PITCH BEND BUTTON* (18) will provide a speed bump and the (-) *PITCH BEND BUTTON* (18) will provide a slow down. The extent to which the speed changes is proportionate to the amount of time either button is held down. For example, if the (+) *PITCH BEND BUTTON* (18) is held down continuously, the disc speed will increases and will continue to increase until reaches a maximum of 16% speed gain. When you release the (+) *PITCH BEND BUTTON* (18) the disc speed will automatically return to it's previous speed.

Holding down or tapping on the (+) *PITCH BEND BUTTON* (18) will provide a speed bump in the playback pitch.

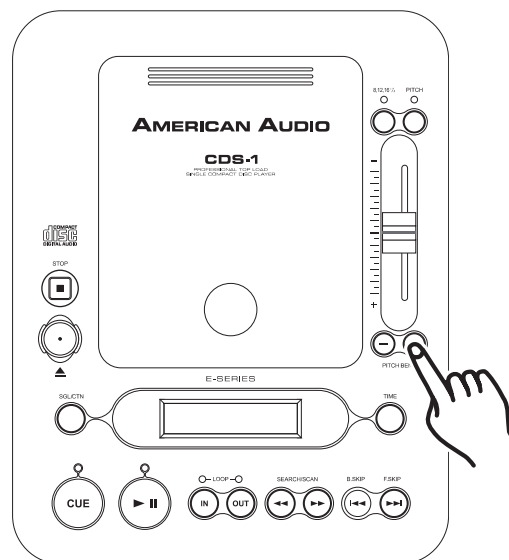

Figure 15

BASIC OPERATIONS (CONT.)

Holding down or tapping on the (-) *PITCH BEND BUTTON* (18) will provide a slow down in the playback pitch.

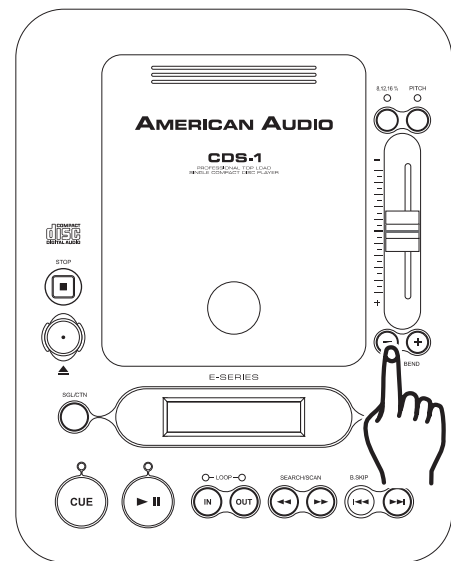

Figure 16

12. CREATING AND PLAYING A LOOP

A loop is a sound clip that plays continuously between two points. You can use this loop to create dramatic effect in your mixing. This loop has no time limit and you could actually loop the entire disc length. You create a loop between two continuous points of a disc. The following steps illustrate the procedures for creating a loop:

- 1) Press the *PLAY/PAUSE BUTTON* (8) to activate playback mode.

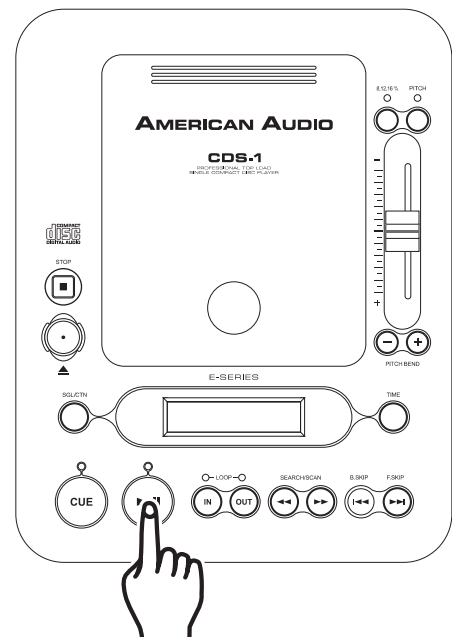
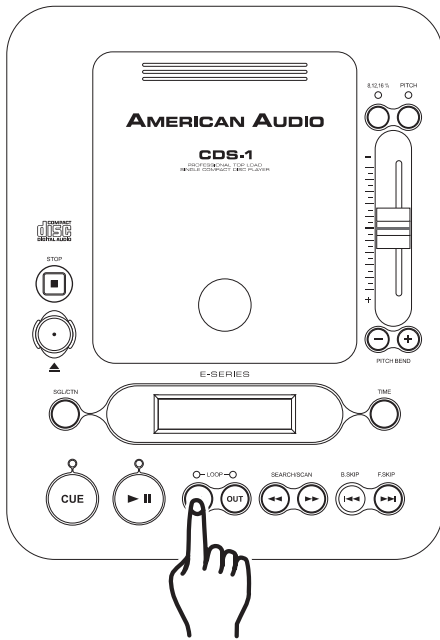

Figure 17

BASIC OPERATIONS (CONT.)



2) Press the *IN BUTTON* (6). This will set a loops starting point. The *IN BUTTON* (6) LED will briefly indicating a starting point has been set.

Figure 18

3) Press the *OUT BUTTON* (11) to set the ending point for your LOOP (Figure 19). The *IN BUTTON LED* (9) and *OUT BUTTON LED* (16) will begin to flash indicating the LOOP mode has been activated.

LOOP INDICATORS - During a loop, the *IN BUTTON LED* (9) and *OUT BUTTON LED* (16) will begin to flash indicating the LOOP mode has been activated.

A loop will remain in memory until a new loop is made or the unit has been powered down. When a loop remain in memory but has been deactivated (exited) the *IN BUTTON LED* (9) and *OUT BUTTON LED* (16) will glow solid red.

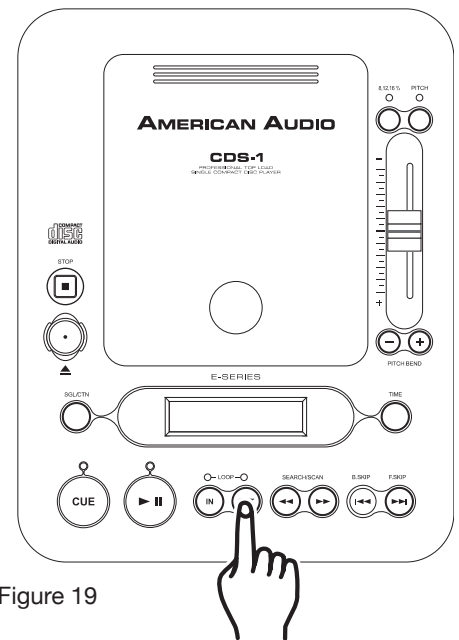
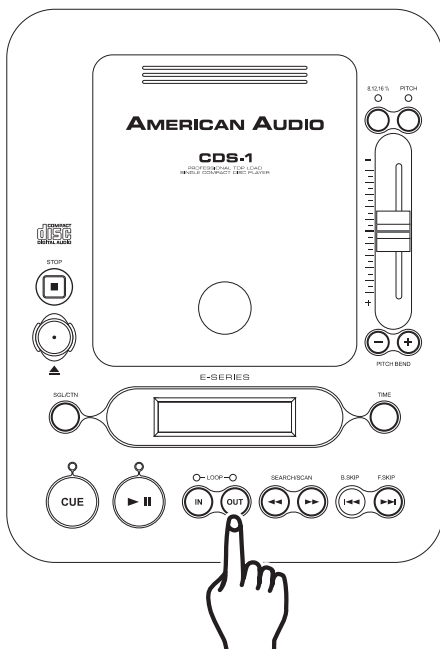

Figure 19



EXITING A LOOP - To exit a LOOP when a loop is active, press the *OUT BUTTON* (11) (Figure 20). The *IN BUTTON* (10) and *OUT BUTTON* (11) LEDs will remain on, but will stop flashing. Music playback will resume normal play. The *IN BUTTON* (10) and *OUT BUTTON* (11) LEDs will remain on to remind you that a loop is stored in memory.

Figure 20

BASIC OPERATIONS (CONT.)

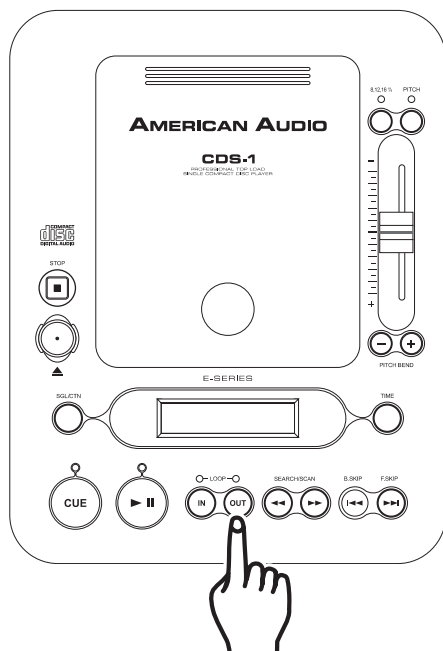

REACTIVATING LOOP - To reactivate a LOOP that is stored in memory but is not playing, press the **OUT BUTTON (11)** (Figure 21). The **IN BUTTON LED (9)** and **OUT BUTTON LED (16)** will begin to flash indicating the LOOP has been activated.

Figure 21

13. SWITCHING BETWEEN SINGLE AND CONTINUOUS PLAY MODES:

This unit allows you to select your play mode between single and continuous. Continuous mode allow the seamless CD playback without interruption, much the same way a typical consumer CD player operates. Single mode will play a track and cue to the next track when the previous track has ended. In certain situations this may be a useful to in preventing unintentional playback of an undesired track. To toggle back and forth between the playback modes press the **SGL/CTN Button (4)**.

Mode Indicator: The "SINGLE" INDICATOR (39) will appear in the LCD (3) when the unit is in playback mode (figure 23). When the unit is in continuous playback mode the "SINGLE" INDICATOR (39) will turn off.

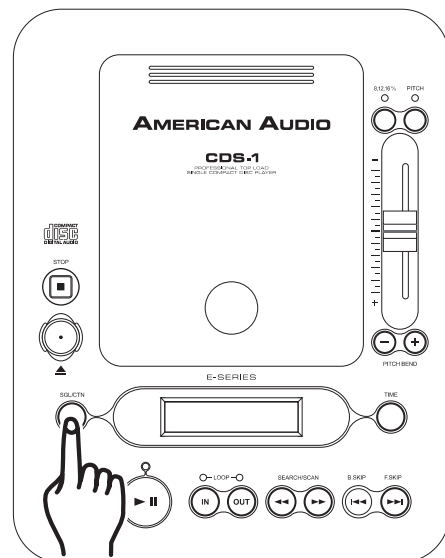

Figure 22

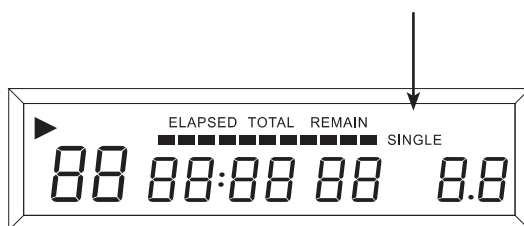
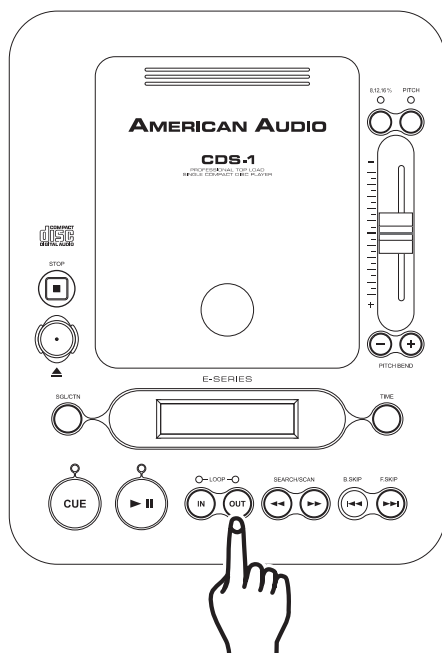

Figure 23

BASIC OPERATIONS (CONT.)



CUE PLAY - This functions allows you to momentary playback from the last cue point when a track is in Cue mode. Simply press and hold down the **CUE BUTTON (6)** when the unit is in cue mode and the unit will begin to playback. Playback will continue until the **CUE BUTTON (6)** is released. Use this function to create mixing and playback effects with other audio sources.

Figure 24

ADVANCED OPERATIONS

FLIP-FLOP™

This feature is kind of "auto pilot." "Flip-Flop" mode can only function with the use of two CDS-1 units. The "Flip-Flop" function may be used with or without an American Audio "Q" deck mixer, you can have one unit begin playback when the other ends. You can "Flip Flop" single tracks, the entire disc, a combination of the two, or you can even "Flip-Flop" your programmed tracks.

To FLIP-FLOP single tracks or programmed tracks:

- 1) Connect your system as described in the set up section on page 6.
- 2) Set your mixer's crossfader to the center position.
- 3) Be sure your two units are single mode. *SINGLE (39)* should be indicated in the *LCD (3)*.
- 4) Load your two CDS-1 with audio disc.
- 5) After they have both cued, press the *PLAY/PAUSE BUTTON (8)* on one of your drive to begin playback.
- 6) After the first unit's single track has ended the second unit's track will immediately begin playback.
- 7) FLIP FLOP will continue until you stop it or power is interrupted.

To FLIP-FLOP entire CDs:

To FLIP-FLOP an entire disc, be sure both drives are in continuous play mode. The *SINGLE ICON (39)* should not be displayed in the *LCD (3)*. When both drives are in continuous play mode, follow the directions for single track FLIP-FLOP as detailed above. When one the disc in one unit ends the other unit will immediately begin playback.

Combining FLIP-FLOP modes:

Flip-Flop modes may combined. One unit may run in single mode and the other in continuous mode. When the units are arranged in this fashion, the unit in single mode will play a single track and flip to the next unit. The next unit will then play the entire disc and flip back to the other. The other will then play the next track and flip back to the other unit, and so on.

Fader Q-Start™

This function works in conjunction with a compatible American Audio "Q-Start" DJ mixer. When used with a compatible CD player, you can use the crossfader to start and stop the CD Player with the slide of the fader.

Connecting your CDS-1 to a Fader "Q" Start mixer for "Flip Flop" control: Be sure to connect 1/8" mini plugs from the control connection on the rear your CDS-1 to the 1/8" control jack on the rear of American DJ or American Audio "Q" series mixer. That's it, you'll be set for FLIP FLOP!

WARRANTY

1-YEAR LIMITED WARRANTY

A. American Audio® hereby warrants, to the original purchaser, American Audio® products to be free of manufacturing defects in material and workmanship for a period of 1 Year (365 days) from the date of purchase. This warranty shall be valid only if the product is purchased within the United States of America, including possessions and territories. It is the owner's responsibility to establish the date and place of purchase by acceptable evidence, at the time service is sought.

B. For warranty service, send the product only to the American Audio® factory. All shipping charges must be pre-paid. If the requested repairs or service (including parts replacement) are within the terms of this warranty, American Audio® will pay return shipping charges only to a designated point within the United States. If the entire instrument is sent, it must be shipped in its original package. No accessories should be shipped with the product. If any accessories are shipped with the product, American Audio® shall have no liability whatsoever for loss of or damage to any such accessories, nor for the safe return thereof.

C. This warranty is void if the serial number has been altered or removed; if the product is modified in any manner which American Audio® concludes, after inspection, affects the reliability of the product; if the product has been repaired or serviced by anyone other than the American Audio® factory unless prior written authorization was issued to purchaser by American Audio®; if the product is damaged because not properly maintained as set forth in the instruction manual.

D. This is not a service contract, and this warranty does not include maintenance, cleaning or periodic check-up. During the period specified above, American Audio® will replace defective parts at its expense, and will absorb all expenses for warranty service and repair labor by reason of defects in material or workmanship. The sole responsibility of American Audio® under this warranty shall be limited to the repair of the product, or replacement thereof, including parts, at the sole discretion of American Audio®. All products covered by this warranty were manufactured after January 1, 1990, and bear identifying marks to that effect.

E. American Audio® reserves the right to make changes in design and/or improvements upon its products without any obligation to include these changes in any products theretofore manufactured.

F. No warranty, whether expressed or implied, is given or made with respect to any accessory supplied with products described above. Except to the extent prohibited by applicable law, all implied warranties made by American Audio® in connection with this product, including warranties of merchantability or fitness, are limited in duration to the warranty period set forth above. And no warranties, whether expressed or implied, including warranties of merchantability or fitness, shall apply to this product after said period has expired. The consumer's and or Dealer's sole remedy shall be such repair or replacement as is expressly provided above; and under no circumstances shall American Audio® be liable for any loss or damage, direct or consequential, arising out of the use of, or inability to use, this product.

G. This warranty is the only written warranty applicable to American Audio® Products and supersedes all prior warranties and written descriptions of warranty terms and conditions heretofore published.

SPECIFICATIONS

GENERAL

Model: American Audio® CDS-1™ - Professional Compact Disc Player

System: Single, Top Loading, Digital Compact Disc Audio Player.
 Disc type: Standard compact discs (5 in / 12cm and 3in/8cm discs)
 Dimensions: 3 1/4" ~ 4 1/2" H x 8 1/2" W x 10 3/8" L
 Installation: Place on flat surface or mount in flat case
 Weight: 3.5 Lbs. / 1.6 kgs
 Power supply: AC 115v/230v, 50/60Hz
 Power consumption: 15W
 Pitch control range: +/-8%, +/-12%, +/-16%
 Pitch bend: +/-16%
 Pitch accuracy: +/- 0.1%
 Environmental conditions: Operational temperature: 5 to 35°C (41 to 95°F)
 Operational humidity: 25 to 85% RH (non-condensation)
 Storage temperature: -20 to 60°C (4 to 140°F)
 Accessories: Dual RCA Cable (for left and right channels)
 Control 1/8" miniplug type (3 feet)

AUDIO SECTION

Quantization: 16 bit linear per channel
 Sampling rate: 44.1 kHz at normal pitch
 Over sampling rate: 8 times over sampling 1 bit D/A converter
 D/A conversion: 16 bit
 Frequency response: +/- 1 dB 20 Hz to 20,000 KHz
 Output level: 2.0V +/- 1dB
 Load impedance: 47k ohm or more

AUDIO CHARACTERISTICS (TEST DISC: TCD-782, LOAD=47Kohm)

ITEM	NOMINAL	LIMIT	CONDITION
Output level	2.0Vrms+/-1dB	2.0V+/-1dB	1KHz,0dB
Channel balance	0.5dB	1.0dB	1KHz,0dB
Frequency response	+/-0.5dB	+/-1.0dB	20Hz-20KHz,0dB
De-emphasis response	+/-2.5dB	+/-3dB 16KHz, -20dB	
Channel separation*	82dB	75dB	1KHz,0dB
T.H.D. + NOISE*	0.02%	0.025%	1KHz,0dB
S/N ratio (IHF-A)*	84dB	75dB	1KHz,0dB

NOTE: *With 20KHz low pass filter.

SEARCHING TIME (TEST DISC: TCD-792)

ITEM	NOMINAL	LIMITS	CONDITION
Short access time	1.7 sec	4 sec	Play next track
Long access time	3 sec	6 sec	Track 1 ->Track 20 / Track 20 ->Track 1
CD recover time	1 sec	2 sec	CD play interrupted by mechanical shock

PLAYABILITY

ITEM	NOMINAL	LIMIT	CONDITION
Interruption	1000um	700um	TCD-725
Black dot	1000um	600um	TCD-725
Finger prints	75um	65um	TCD-725
Eccentricity	210um	140um	TCD-712,713 NO TRACK JUMP
Vertical deviation	1mm	0.54mm	TCD-731R

PICK-UP

System: Object lens drive system optical pick-up
 Object lens drive system: 2 dimensional parallel drive
 Tracking detection: 3 spot beam detection
 Optical source: Semiconductor laser
 Wave length: 780nm

NOTES:

**The specifications are subject to change to any improvement by negotiations in advance.
 The parts are subject to change to any improvement within the range of the specifications.**





©American Audio
A Division of the American DJ Group of Companies
American Audio World Headquarters:
4295 Charter Street
Los Angeles, CA 90058 USA
Tel: 323-582-2650 Fax: 323-582-2610
Web: www.AmericanAudio.us E-mail:

Free Manuals Download Website

<http://myh66.com>

<http://usermanuals.us>

<http://www.somanuals.com>

<http://www.4manuals.cc>

<http://www.manual-lib.com>

<http://www.404manual.com>

<http://www.luxmanual.com>

<http://aubethermostatmanual.com>

Golf course search by state

<http://golfingnear.com>

Email search by domain

<http://emailbydomain.com>

Auto manuals search

<http://auto.somanuals.com>

TV manuals search

<http://tv.somanuals.com>