

AD-15/AD-24/AD-25/AD-30/AD-285/AD-50

Installation Manual

(Gas / Electric / Steam)

Phase 3 Coin / Phase 4 Coin / Phase II Non-Coin

WARNING: For your safety the information in this manual must be followed to minimize the risk of fire or explosion or to prevent property damage, personal injury or death.

— Do not store or use gasoline or other flammable vapors and liquids in the vicinity of this or any other appliance.

— WHAT TO DO IF YOU SMELL GAS:

- Do not try to light any appliance.
- Do not touch any electrical switch; do not use any phone in your building.
- Clear the room, building or area of all occupants.
- Immediately call your gas supplier from a neighbor's phone. Follow the gas supplier's instructions.
- If you cannot reach your gas supplier, call the fire department.

— Installation and service must be performed by a qualified installer, service agency or the gas supplier.

AVERTISSEMENT: Assurez-vous de bien suivre les instructions données dans cette notice pour réduire au minimum le risque d'incendie ou d'explosion ou pour éviter tout dommage matériel, toute blessure ou la mort.

— Ne pas entreposer ni utiliser d'essence ni d'autres vapeurs ou liquides inflammables à proximité de cet appareil ou de tout autre appareil.

— QUE FAIRE SI VOUS SENTEZ UNE ODEUR DE GAZ:

- Ne pas tenter d'allumer d'appareils.
- Ne touchez à aucun interrupteur. Ne pas vous servir des téléphones se trouvant dans le bâtiment.
- Évacuez la pièce, le bâtiment ou la zone.
- Appelez immédiatement votre fournisseur de gaz depuis un voisin. Suivez les instructions du fournisseur.
- Si vous ne pouvez rejoindre le fournisseur de gaz, appelez le service des incendies.

— L'installation et l'entretien doivent être assurés par un installateur ou un service d'entretien qualifié ou par le fournisseur de gaz.



American Dryer Corporation
88 Currant Road
Fall River MA 02720-4781 USA
Telephone: (508) 678-9000 / Fax: (508) 678-9447
e-mail: techsupport@amdry.com

www.amdry.com

ADC Part No. 112100

Retain This Manual In A Safe Place For Future Reference

American Dryer Corporation products embody advanced concepts in engineering, design, and safety. If this product is properly maintained, it will provide many years of safe, efficient, and trouble free operation.

ONLY qualified technicians should service this equipment.

OBSERVE ALL SAFETY PRECAUTIONS displayed on the equipment or specified in the installation manual included with the dryer.

The following “**FOR YOUR SAFETY**” caution **must be** posted near the dryer in a prominent location.

FOR YOUR SAFETY

Do not store or use gasoline or other flammable vapors and liquids in the vicinity of this or any other appliance.

POUR VOTRE SÉCURITÉ

Ne pas entreposer ni utiliser d'essence ni d'autres vapeurs ou liquides inflammables à proximité de cet appareil ou de tout autre appareil.

We have tried to make this manual as complete as possible and hope you will find it useful. **ADC** reserves the right to make changes from time to time, without notice or obligation, in prices, specifications, colors, and material, and to change or discontinue models. The illustrations included in this manual may not depict your particular dryer **exactly**.

Important

For your convenience, log the following information:

DATE OF PURCHASE _____ **MODEL NO.** _____

RESELLER'S NAME _____

Serial Number(s) _____

Replacement parts can be obtained from your reseller or the **ADC** factory. When ordering replacement parts from the factory, you can FAX your order to **ADC** at (508) 678-9447 or telephone your order directly to the **ADC** Parts Department at (508) 678-9000. Please specify the dryer **model number** and **serial number** in addition to the **description** and **part number**, so that your order is processed accurately and promptly.

“IMPORTANT NOTE TO PURCHASER”

Information **must be** obtained from your local gas supplier on the instructions to be followed if the user smells gas. These instructions **must be** posted in a prominent location near the dryer.

IMPORTANT

YOU MUST DISCONNECT AND LOCKOUT THE ELECTRIC SUPPLY AND THE GAS SUPPLY OR THE STEAM SUPPLY BEFORE ANY COVERS OR GUARDS ARE REMOVED FROM THE MACHINE TO ALLOW ACCESS FOR CLEANING, ADJUSTING, INSTALLATION, OR TESTING OF ANY EQUIPMENT PER OSHA (Occupational Safety and Health Administration) STANDARDS.

“Caution: Label all wires prior to disconnection when servicing controls. Wiring errors can cause improper operation.”

«Attention: Au moment de l'entretien des commandes, étiquetez tous les fils avant de les débrancher. Des erreurs de câblage peuvent entraîner un fonctionnement inadéquat et dangereux.»

CAUTION

DRYERS SHOULD NEVER BE LEFT UNATTENDED WHILE IN OPERATION.

WARNING

CHILDREN SHOULD NOT BE ALLOWED TO PLAY ON OR NEAR THE DRYER(S).
CHILDREN SHOULD BE SUPERVISED IF NEAR DRYERS IN OPERATION.

FOR YOUR SAFETY

DO NOT DRY MOP HEADS IN THE DRYER.

DO NOT USE DRYER IN THE PRESENCE OF DRY CLEANING FUMES.

WARNING

UNDER NO CIRCUMSTANCES should the door switch or the heat circuit devices ever be disabled.

WARNING

The dryer *must never be* operated with any of the back guards, outer tops, or service panels removed. **PERSONAL INJURY OR FIRE COULD RESULT.**

WARNING

DRYER *MUST NEVER BE* OPERATED WITHOUT THE LINT FILTER/SCREEN IN PLACE, EVEN IF AN EXTERNAL LINT COLLECTION SYSTEM IS USED.

IMPORTANT

PLEASE OBSERVE ALL SAFETY PRECAUTIONS displayed on the equipment and/or specified in the installation manual included with the dryer.

Dryers *must not be* installed or stored in an area where it **will be** exposed to water or weather.

The wiring diagram for the dryer is located in the front electrical control box area.

Table of Contents

SECTION I

INTRODUCTION.....	4
Phase 3 Features	4

SECTION II

INSTALLATION PROCEDURES	7
A. Installation	7
B. Location of the Dryer	7
C. Dryer Enclosure	8
D. Air Intake	8
E. Exhaust Ducting	8
F. Common Main Duct	9
G. Electric Dryers	9
H. Gas Dryers	10
I. Gas Flame Adjustment	10
J. Steam Dryers (Low-Pressure)	10
K. Steam Dryers (High-Pressure)	11
L. Basket (Tumbler)	11
M. Grounding	11

SECTION III

L.E.D. DISPLAY AND CODES	12
---------------------------------------	-----------

SECTION IV

OPERATING INSTRUCTIONS.....	13
A. Timed Mode	13
B. Automatic Mode	13
C. Free Dry Mode	14

SECTION V

PROGRAM SELECTIONS	15
Temperature Display Mode	15
Right Coin Count (rCC)	15
Left Coin Count (LCC)	15
PL01 - Temperature Conversion Status	15
Automatic Mode	15
Timed Mode (tInE)	16
Antiwrinkle Program (Grd)	16
Buzzer/Tone (bUZ)	16
Free Dry Mode (FrEE)	16
Coin Mode (Coin)	16

Flash Display Status (FLS)	16
Bad Coin Lockout Status (bCLO)	17
Bad Coin Reset (bCrS)	17
Accumulative Time (AtIn)	17
Accumulative Coin (ACOn)	19
PL02 - Dryness Level (drYL)	20
PL03 - High Temperature (HI°F)	20
PL04 - High Cool Down Temperature/Time (HICd)	20
PL05 - Low Temperature (LO°F)	20
PL06 - Low Cool Down Temperature/Time (LOCd)	20
PL07 - Permanent Press (PP°F)	20
PL08 - Perm Press Cool Down Temperature/Time (PPCd)	20
PL09 - Left Coin Slot Denomination (LCdE)	21
PL10 - Right Coin Slot Denomination (rCdE)	21
PL11 - Time Per Left Coin (tPLC)	21
PL12 - Amount To Start (AtSt)	21
PL13 - Minimum Amount For Additional Time (AFAt)	21
PL14 - Maximum Automatic Dryness Time (Adrt)	21
PL15 - Antiwrinkle Timing	22
PL16 - Active Guard Time (AGt)	22

SECTION VI

INTRODUCTION TO PROGRAMMING	23
--	-----------

SECTION VII

PROGRAMMING	25
--------------------------	-----------

A. Temperature Display Mode	25
B. Right Coin Count (rCC)	26
C. Left Coin Count (LCC)	27
D. Program Location 01 (PL01)	28
E. Program Location 02 (PL02)	32
F. Program Location 03 (PL03)	33
G. Program Location 04 (PL04)	34
H. Program Location 05 (PL05)	35
I. Program Location 06 (PL06)	36
J. Program Location 07 (PL07)	37
K. Program Location 08 (PL08)	38
L. Program Location 09 (PL09)	39
M. Program Location 10 (PL10)	40
N. Program Location 11 (PL11)	41
O. Program Location 12 (PL12)	42
P. Program Location 13 (PL13)	43
Q. Program Location 14 (PL14)	44
R. Program Location 15 (PL15)	45
S. Program Location 16 (PL16)	46

SECTION VIII	
FACTORY PRESET PROGRAMS	47
Dual Coin	47
Single Coin	48
SECTION IX	
NON-COIN COMPUTER DRYER.....	49
Non-Coin Features	49
Non-Coin Computer Dip Switch Features	50
Operating Instructions - Non-Coin Computer Dryer	51
A. Computer Display Codes	51
B. Automatic Only (Non-Reversing Dryers)	52
C. Automatic/Manual Program Selectable (“Auto” Selected, Non-Reversing Dryers)	52
D. Automatic/Manual Program Selectable (“Manual” Selected, Non-Reversing Dryers)	53
E. Microprocessor Reversing Dryer	53
SECTION X	
SERVICE/PARTS INFORMATION	55
A. Service	55
B. Parts	55
SECTION XI	
REPLACEMENT PARTS LIST	56
SECTION XII	
WARRANTY INFORMATION.....	58
A. Returning Warranty Cards	58
B. Warranty	58
C. Returning Warranty Parts	58
SECTION XIII	
ROUTINE MAINTENANCE	60
A. Cleaning	60
B. Adjustments	61
C. Lubrication	61
SECTION XIV	
TROUBLESHOOTING	62
SECTION XV	
OPTIONAL 9 VOLT BATTERY BACKUP	66

SECTION I

INTRODUCTION

The Phase 3 computerized system is a fully programmable, highly sophisticated dryer control system. **ADC** has designed the Phase 3 to be the most versatile and reliable coin-op control system available.

To eliminate as many moving parts as possible, **ALL** Phase 3 programming is done through the membrane switch on the front of the control panel. The switch (PS) that puts the computer into the program mode is a single, sealed, military specification toggle switch. This toggle switch (PS) eliminates the possibility of switch failure due to an accumulation of lint or moisture.

PHASE 3 FEATURES

Programmable

Changes in programs are made at the temperature selection keyboard (touch pad), and actual programs are displayed for verification.

Adjustable Time

Programmable from a minimum of 1 minute to a maximum of 99 minutes in 1 minute increments.

Coin Acceptor Denominations

Values of the coin acceptors are programmable from a minimum of 1 to a maximum value of 9999 for any U.S. or foreign coin denomination.

Amount To Start

Programmable from a minimum value of 1 to a maximum value of 9999 in increments of one (1).

Accumulative Time

This program yields a specific value of time for any coin entry made after the "Amount To Start" has been inserted.

Accumulative Coin

This program selection requires that a specific value of coin(s) be inserted for additional time, programmable for any minimum amount.

Coin Count

The number of coins inserted, including a separate display program for optional dual coin acceptors, can be viewed through the Phase 3 computer's light emitting diode (L.E.D.) display.

Bad Coin Lockout

Each coin entry is monitored. Should someone tamper with the coin acceptor or attempt to insert a foreign object, the microprocessor controller (computer) will “LOCK UP” and will not accept any entries until the reset time has elapsed (approximately 15-seconds). Once the reset time has expired, the microprocessor controller (computer) will automatically reset itself for the next coin entry.

Temperature Conversion

When the temperature conversion status is changed (i.e., from °F to °C), the microprocessor controller (computer) will automatically convert **ALL** temperature related programs/parameters from Fahrenheit to Celsius and vice versa. The microprocessor controller (computer) will perform this conversion within 2° Celsius. The programs affected are:

1. Temperature Display Mode
2. Temperature Selections
3. Cool Down Temperatures

Drying Temperatures

Any of the three (3) temperature selections (HI/LO/PP) are programmable from a minimum of 100° F (38° C) to a maximum of 190° F (88° C) in ten-degree increments or from a minimum 35° C (95° F) to a maximum of 90° C (194° F) in five-degree increments. Actual temperature programs are displayed at time of programming for verification.

Cool Down Time

ALL three (3) temperature selections are programmable from a minimum of 0 to a maximum of 9 minutes in 1 minute increments.

Cool Down Temperatures

In the automatic or free dry modes, the cool down cycle termination is programmable from a minimum of 100° F (38° C) to a maximum of 190° F (88° C) in ten-degree increments or, from a minimum of 35° C (95° F) to a maximum of 90° C (194° F) in five-degree increments.

Automatic Mode

This program will cycle the dryer off when the preprogrammed dryness level (1 to 99) or maximum cutoff time (Adrt) (1 to 99 minutes) has been reached, whichever comes first.

Antiwrinkle

This program selection helps keep permanent press items wrinkle free, when they are not removed from the dryer promptly at the end of the drying and cooling cycle. The owner programs the dryer to automatically restart in the cool down cycle, if the clothes are not removed in a preprogrammed amount of time. The Antiwrinkle Program settings are:

1. Guard Delay Time ----- 1 to 9 minutes
2. Guard On Time ----- 1 to 99-seconds
3. Active Guard Time ----- 1 to 99 minutes

Free Dry Mode

In this program mode, the computer automatically reverts to the automatic mode. However, no coins are required to start the dryer.

Light Emitting Diode (L.E.D.) Flash Display

Programmable to allow the L.E.D. readout to display a choice of "FILL" (no cycle in progress), "Amount To Start" (i.e., 25¢), or in the case of free dry, "FrEE." This program selection also allows the L.E.D. display to flash back and forth every 2-seconds from "FILL" to "Amount To Start" or, in the case of free dry, from "FILL" to "FrEE."

Audible Tone

In this program selection, a buzzer (tone) will sound for each coin inserted, program entry, or at the end of the drying cycle and cooling cycle for a period of 5-seconds to indicate that the cycle is complete. Additionally, when in the Antiwrinkle program, the buzzer (tone) will sound for 5-seconds at the end of the "Guard On Time."

Temperature Display

This program selection enables the temperature in the dryer to be viewed (°F or °C) either while the dryer is off or running. This service feature shows that the dryer is maintaining the selected temperature.

Diagnostics

ALL major circuits, including door, microprocessor temperature sensor, heat, and motor circuits are monitored.

Battery Backup (Optional)

This feature allows the microprocessor controller (computer) to maintain its operating status should a momentary power interruption occur while the dryer cycle is in progress.

SECTION II

INSTALLATION PROCEDURES

A. INSTALLATION

The dryer is mounted on a skid by four (4) bolts. The front two (2) bolts are located on the floor of the lint compartment. The other two (2) are located on the base at the rear of the dryer.

NOTE: Always keep the dryer in an upright position.

B. LOCATION OF THE DRYER

Approximately 2 feet (0.609 meters) **should be** allowed at the rear of the dryer for the duct and for ease of maintenance. The dryer **should be** level. The four (4) legs are adjustable. (Refer to the **illustration below** for details). Other factors to keep in mind include the following:

1. The main duct of the dryer **must be** tapered.
2. The minimum increase in cross section area for each 6-inch (15.24 cm) duct added is 45 square inches (290.32 square centimeters) and 75 square inches (483.87 square centimeters) for each 8-inch (20.32 cm) duct added.
3. Ducts should enter the main duct at the bottom or on the side at no more than a 45° angle.
4. Each exhaust duct should enter the main duct at least 34-inches (86.36 cm) apart.
5. The dryer **must be** installed with a proper exhaust duct connection to the outside.
6. The dryer **must be** installed with provisions for adequate combustion and make-up air supply.

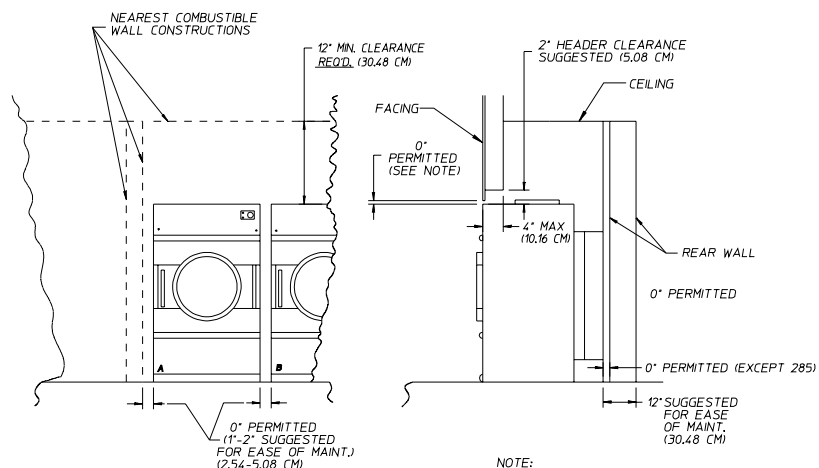

- NOTE:
1. 0" DIMENSION PERMITTED ON HEAT RECLAIMER MODELS AFTER INSTALLATION.
 2. BONNET EXTENDS UP 1 3/4" ABOVE DRYER ON ALL MODELS EXCEPT 285.
 3. 285 EXHAUST DUCT COLLAR EXTENDS ABOVE DRYER 1 7/8".

INSTALLATION: DRYER CLEARANCE TO ADJACENT WALL STRUCTURES.

MAN2753

CAUTION: This dryer produces combustible lint and *must be* exhausted to the outdoors. Every 6 months, inspect the exhaust ducting and remove any lint build up.

C. DRYER ENCLOSURE

Bulkheads and partitions **should be** made of noncombustible materials.

D. AIR INTAKE

Make-up air will effect drying time, efficiency, and fire safety margins. Make-up air openings from an outside source **should be** two (2) to three (3) times the cross section area of the exhaust on gas and electric dryers, and four (4) to five (5) times the area for steam dryers. The dryer **must be** installed with provisions for adequate combustion and make-up air supply.

E. EXHAUST DUCTING

Whenever possible, exhaust each dryer separately. Never reduce the air outlet diameter of the dryer.

Avoid 90° right angle turns in the ducting. Where turns are necessary, use 45° or 30° angles instead.

Avoid any screw or object that would protrude inside the exhaust duct and create a lint build up.

DO NOT use screws or caps on exhaust.

If the exhaust duct goes through the roof, it may be protected from the weather by using a 180° turn to point the opening downward. If it goes through the wall, use a 90° turn to point the opening downward. (Refer to the **illustration below.**) The dryer **must be** installed with a proper exhaust duct connection to the outside.

CAUTION: This dryer produces combustible lint and *must be* exhausted to the outdoors.

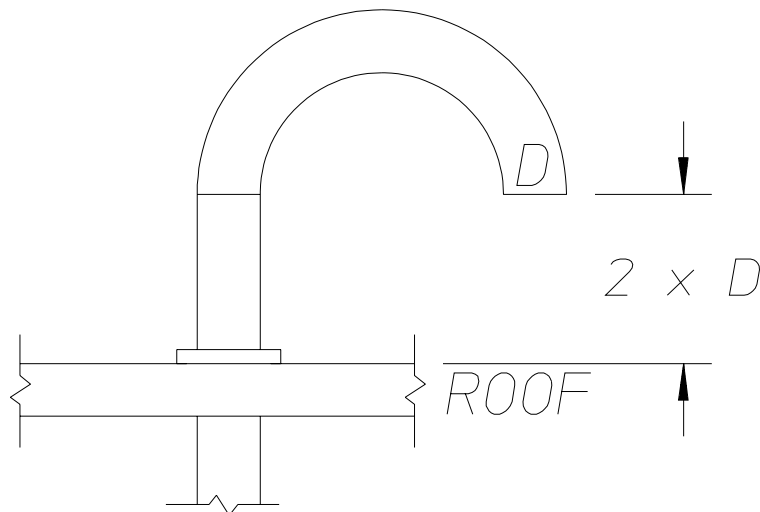

MAN2748

F. COMMON MAIN DUCT

When individual exhaust is impossible, a common main duct may be used. However, strict attention **must be** given to the construction of the duct to insure proper exhaust and to prevent restrictions in the airflow. (Refer to the **illustrations below.**)

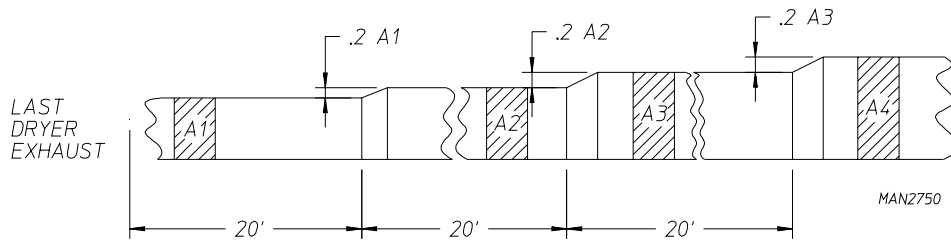

INCREASE OF DUCT AREA FOR LONG EXHAUST DUCT INSTALLATIONS.

DUCT DIA. FROM DRYER	MINIMUM CROSS-SECTION AREA IN SQ. IN. & SQ. CM.											
6" DIA 152 M.M.	530	485	440	390	350	315	270	225	180	135	90	45
	3419	3129	2839	2547	2257	2031	1741	1451	1161	870	580	290
8" DIA 203 M.M.	900	825	750	675	600	525	450	375	300	225	150	75
	5806	5322	4838	4354	3871	3387	2903	2418	1935	1451	967	483

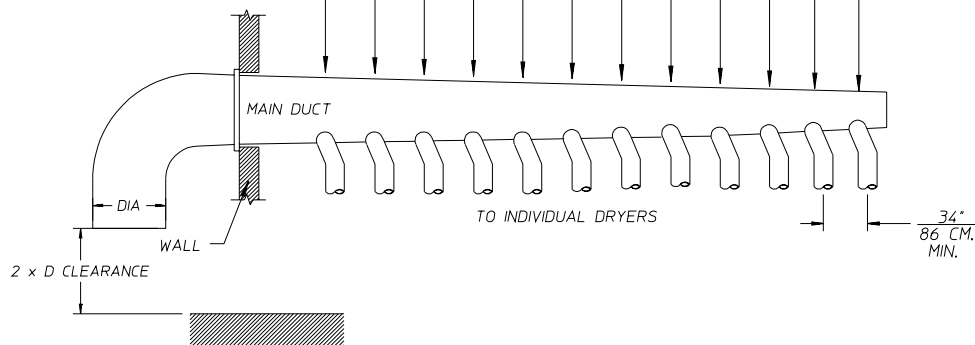

NOTE: FOR $\frac{6"}{152}$ DIA AND $\frac{8"}{203}$ DIA DUCTS FROM DRYER, ADD $\frac{45}{290}$ SQ. M. TO CROSS

SECTIONS OF MAIN DUCT INTRODUCED AND $\frac{75}{483}$ SQ. M. FOR EACH

$\frac{8"}{203}$ DIA DUCTS INTRODUCED.

MAN2749

G. ELECTRIC DRYERS

Insure that the power supply is sufficient to operate the dryer. Low voltage and amperage will cause poor drying, overheated motors, poor relay function, and reduced fire safety margins.

Electrical connections **should only be** made by qualified personnel.

NOTE: Only copper cable of proper size **should be** used on these dryers. The use of aluminum wire **VOIDS THE WARRANTY.**

H. GAS DRYERS

ALL dryers are provided with 1/2" gas lines. Consult your local gas supplier for correct line size and pressure. The built in regulator provides 3.5 inches (8.7 mb) water column (W.C.) at the manifold for natural gas. Liquid propane (L.P.) gas **must be** regulated in line by the supplier to 10.5 inches (26.1 mb) water column. A shutoff valve **should be** installed at the rear of the dryer for easy servicing and safety. Gas connections **should only be** made by qualified personnel.

I. GAS FLAME ADJUSTMENT

Dryers are equipped at the factory with the correct orifice and are adjusted for proper performance. Should further adjustment be needed, rotate the air adjustment plate until yellow flame is at a minimum.

IMPORTANT: Test **ALL** connections for gas leaks by brushing on a soapy solution (liquid detergent works well).

WARNING: NEVER TEST FOR GAS LEAKS WITH A FLAME!!!

J. STEAM DRYERS (LOW-PRESSURE)

Low-pressure steam (10-15 psig [0.69-1.03 bars]) has a minimum push through the systems, therefore, the following is recommended for 3 to 7 dryers:

1. 3" main steam line
2. 2" return line
3. 1" line from main line to each dryer
4. 1" line from dryer to return lines

Piping **should be** installed with good commercial steam system practices. (Refer to the **illustration below.**)

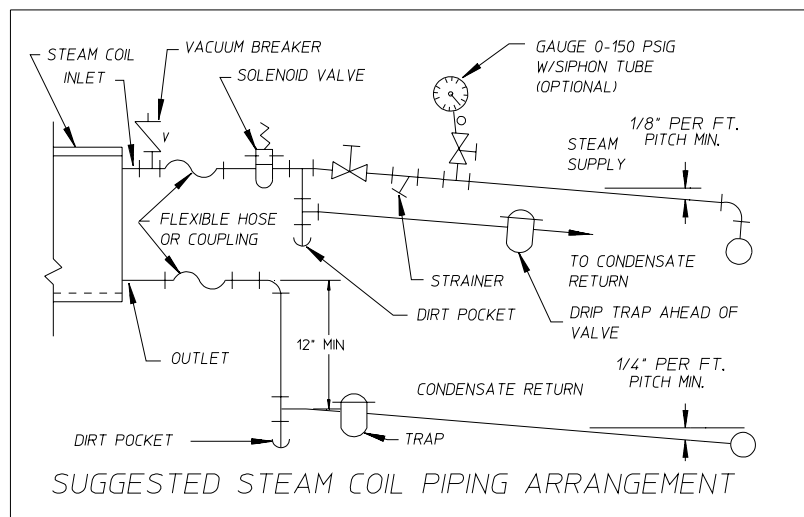

MAN2752

An impulse trap and filter **should be** installed at each dryer. After 1 or 2 days of operation, the following maintenance **should be** performed:

1. Pressure **should be** 10-15 psig (0.69-1.03 bars).
2. Filter and traps **should be** clean and operational.
3. There **should be** proper flow of steam and condensate.
4. There **should be** sufficient make-up air to the heat exchanger.
5. The dryer **should be** properly exhausted.

K. STEAM DRYERS (HIGH-PRESSURE)

A high-pressure steam dryer is similar to a low-pressure one, but has a 125 psig (8.6 bars) maximum. Maintenance is the same. Each coil is supplied by a 1" inlet and the outlet is a 1-2" line.

L. BASKET (TUMBLER)

The basket (tumbler) is adjusted at the factory. However, handling in shipment could cause misalignment. If adjustment is necessary, follow the instructions in the service manual.

BASKET (TUMBLER) COATING

The basket (tumbler) is treated with a protective coating. We suggest dampening old garments or cloth material with a solution of water and nonflammable mild detergent and tumbling them in the basket (tumbler) to remove this coating.

M. GROUNDING

Computer dryers **should be** individually grounded. A copper or brass stake driven into the ground is the best grounding method.

The dryer and its individual shutoff valve **must be** disconnected from the gas supply piping system during any pressure testing of that system at test pressures in excess of 1/2 psig (3.5 kPa).

The dryer **must be** isolated from the gas supply piping system by closing its individual manual shutoff valve during any pressure testing of the gas supply piping system at test pressures equal to or less than 1/2 psig (3.5 kPa).

SECTION III

L.E.D. DISPLAY AND CODES

ACOn	Accumulative Coin
Adrt	Maximum Auto Dryness Time
AFAt	Amount For Additional Time
AGt	Active Antiwrinkle Guard Time
AtIn	Accumulative Time
AtSt	Amount To Start
AUtO	Automatic Mode
bCLO	Bad Coin Lockout
bCrS	Bad Coin Reset
bUZ	Buzzer (Tone)
°CEL	Degree in Celsius
CLCC	Clear Left Coin Count
Coin	Coin Mode
CrCC	Clear Right Coin Count
donE	Drying and Cooling Cycles Complete or Dryer is in Antiwrinkle Cycle
door	Door Circuit is Open
drYL	Dryness Level
dSFL	Dryer Sensor Circuit Failure
°FAr	Degree in Fahrenheit
FILL	No Cycle in Progress
FLS	Flash Display Active
FrEE	Free Dry Mode
GdLY	Antiwrinkle Delay Time
Gont	Antiwrinkle On Time
Grd	Antiwrinkle Program Active
HICd	High Cool Down
LCC	Left Coin Count
LCdE	Left Coin Denomination
LOCd	Low Cool Down
nbUZ	No Buzzer (Tone)
nFLS	No Flash Display
nGrd	No Antiwrinkle
OFF	Bad Coin Lockout Program Tripped
PL	Program Location
PPCd	Permanent Press Cool Down
PUSH	Amount To Start has been Inserted, Make Temperature Selection
rCC	Right Coin Count
rCdE	Right Coin Denomination
tInE	Timed Mode
tPLC	Time Per Left Coin

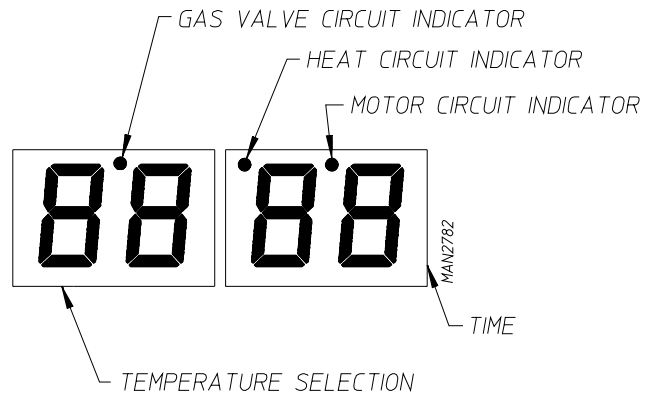

SECTION IV

OPERATING INSTRUCTIONS

NOTE: Unless otherwise specified at the time of ordering, the Phase 3 microprocessor controller (computer) has been programmed by the factory with the parameters shown on **page 47** and **page 48**. Should program changes be found necessary, please read this manual carefully to thoroughly familiarize yourself with the Phase 3 programming characteristics.

A. TIMED MODE

1. When turning on power or when no cycle is in progress, the light emitting diode (L.E.D.) display will read "FILL" and/or "Amount To Start" ("AtSt").
2. Insert coin(s). Once the correct "Amount To Start" has been inserted, the L.E.D. display will read "PUSH."
3. Select temperature by pushing "HI TEMP," "LO TEMP," or "PERM PRESS." The dryer will start, and the L.E.D. display will read the temperature cycle selected and the drying time.
4. The dryer will continue through the drying and cooling cycles, showing time counting downward.

NOTE: If the door is opened during a cycle, both the heat and motor will stop. However, the Phase 3 microprocessor controller (computer) will continue to count down in time. Continuation of the cycle will resume only after the door has been closed and any one of three (3) temperature selection buttons is again depressed.

5. Upon completion of the drying and cooling cycles, the buzzer (tone) will sound, and the L.E.D. display will read "donE" for 5-seconds, at which time the dryer will shut off.

NOTE: If the Antiwrinkle Program is active ("Grd"), the L.E.D. display will remain reading "donE," and the Phase 3 microprocessor controller (computer) will proceed through the Antiwrinkle Program until the maximum "Guard On Time" has expired or until the door is opened, whichever comes first. The L.E.D. display will read "FILL" and/or "Amount To Start" ("AtSt").

NOTE: If the Antiwrinkle Program **is not** active ("nGrd"), the L.E.D. display will read "donE" until the main door is opened, at which time the L.E.D. display will read "FILL" and/or "Amount To Start" ("AtSt").

B. AUTOMATIC MODE

1. When turning on power or when no cycle is in progress, the L.E.D. display will read "FILL" and/or "Amount To Start" ("AtSt").
2. Insert coin(s). Once correct "Amount To Start" has been inserted, the L.E.D. display will read "PUSH."

3. Select temperature by pushing “HI TEMP,” “LO TEMP,” or “PERM PRESS.” The dryer will start, the light emitting diode (L.E.D.) display will read the temperature cycle selected, and the drying time portion of the L.E.D. display will read “00” and count upward as time elapses.

NOTE: If the door is opened during a cycle, both the heat and motor will stop. However, the Phase 3 microprocessor controller (computer) will continue to count upwards in time. Continuation of the cycle will resume only after the door has been closed and any one of the three (3) temperature selection buttons is again depressed.

4. Once the preprogrammed dryness level and cool down period have been reached or the maximum automatic time has expired, whichever comes first, the buzzer (tone) will sound, and the L.E.D. display will read “donE” for 5-seconds, at which time the dryer will shut off.

NOTE: If the Antiwrinkle Program is active (“Grd”), the L.E.D. display will remain reading “donE,” and the Phase 3 microprocessor controller (computer) will proceed through the Antiwrinkle Program until the maximum “Guard On Time” has expired or until the door is opened, whichever comes first. The L.E.D. display will read “FILL” and/or “Amount To Start” (“AtSt”).

NOTE: If the Antiwrinkle Program **is not** active (“nGrd”) the L.E.D. display will read “donE” until the main door is opened, at which time the L.E.D. display will read “FILL” and/or “Amount To Start.”

C. FREE DRY MODE

1. When turning on power or when no cycle is in progress, the L.E.D. display will read “FILL” and/or “FrEE.”
2. Select temperature. The dryer will start, the L.E.D. display will read the temperature cycle selected, and the drying portion of the L.E.D. display will read “00” and count upwards as time elapses.

NOTE: If the door is opened during a cycle, both the heat and motor will stop. However, the Phase 3 microprocessor controller (computer) will continue to count upwards in time. Continuation of the cycle will resume only after the door has been closed and any one of the three (3) temperature selection buttons is again depressed.

3. Once the preprogrammed dryness level and cool down period has been reached or the maximum automatic time has expired, whichever comes first, the buzzer (tone) will sound, and the L.E.D. display will read “donE” for 5-seconds, at which time the dryer will shut off.

NOTE: If the Antiwrinkle Program is active (“Grd”), the L.E.D. display will remain reading “donE,” and the Phase 3 microprocessor controller (computer) will proceed through the Antiwrinkle Program until the maximum “Guard On Time” has expired or until the door is opened, whichever comes first. The L.E.D. display will read “FILL” and/or “Amount To Start” (“AtSt”).

NOTE: If the Antiwrinkle Program **is not** active (“nGrd”) the L.E.D. display will read “donE” until the main door is opened, at which time the L.E.D. display will read “FILL” and/or “Amount To Start.”

SECTION V

PROGRAM SELECTIONS

NOTE: Programs are stored in the computer memory and are cataloged as program locations (PL).

Temperature Display Mode

By closing the Program Switch (PS), the display will read the temperature in the dryer in either Fahrenheit or Celsius, depending on how the **PL01** temperature conversion status is set. The temperature display mode can be activated while the dryer is in the operating cycle or off. While in the operating cycle, the circuit indicators are visible for troubleshooting purposes.

NOTE: The dryer **cannot** be started while the computer program switch (PS) is closed unless the cycle was already in progress.

Right Coin Count (rCC)

For models equipped with the optional dual coin acceptor, by closing the program switch and pushing the “HI TEMP” keyboard (touch pad) selection button, the amount of coins inserted through the right coin slot of the coin acceptor can be viewed through the light emitting diode (L.E.D.) display. The computer memory will retain a running count of up to 9999 coins and can be cleared (CrCC) by following the program procedure on **page 26**.

Left Coin Count (LCC)

The number of coins inserted for a single coin acceptor dryer or in the case of a dual coin acceptor, the left coin slot can be viewed through the L.E.D. display by closing the program switch and pushing the “LO TEMP” keyboard (touch pad) selection button. The computer memory will retain a running count of up to 9999 coins and can be cleared (CLCC) by following the procedure on **page 27**.

PL01 - Temperature Conversion Status

This program controls whether the temperature-related programs will be operated in Fahrenheit or Celsius. Programs affected are:

1. Temperature display mode
2. Selection cycling temperatures
3. Cool down temperatures

Automatic Mode

When this parameter (“AUtO”) is selected, the dryer will run for a preset level of dryness (**PL02**) or until the programmed automatic maximum time (**PL14**) has expired.

At the end of the drying cycle, the dryer will go into the cool down cycle for the time period programmed (**PL04**, **PL06**, or **PL08**) or until the temperature has dropped to the programmed cool down temperature (**PL04**, **PL06**, or **PL08**).

NOTE: Due to humidity, atmospheric pressure, percentage of extraction, etc., the desired dryness level may vary. It is suggested that the owner determine which level of dryness (90% to 100%) is best suited for his/her application by experimenting with a few test loads.

Timed Mode (tInE)

When this parameter is selected (“tInE”) and the Phase 3 microprocessor controller (computer) has been activated, the dryer will continue to run until the preset time, including the cool down period (**PL04**, **PL06**, or **PL08**), has elapsed, at which time the dryer will cycle off or go into the optional Antiwrinkle Program.

Antiwrinkle Program (Grd)

This feature can be used in conjunction with any of the three (3) operating modes (Coin Mode, Auto Mode, or the Free Dry Mode). In this program (“Grd”), when the drying and cooling cycles are completed, the dryer will shut off, the tone will sound, and the light emitting diode (L.E.D.) display will read “donE.” If the door is not opened, the Phase 3 microprocessor controller (computer) will wait until the “Guard Delay Time” (**PL15**) has expired, at which time the clothes will be tumbled (without heat) for the programmed “Guard On Time” (**PL15**). The Phase 3 microprocessor controller (computer) will repeat the process until the programmed “Active Guard Time” (**PL16**) has expired or until the dryer door is opened, at which time the L.E.D. display will read “FILL” and/or “Amount To Start” (“AtSt”), or “FILL” and/or “FrEE.”

Buzzer/Tone (bUZ)

With the Antiwrinkle Program active, the option is available to have the buzzer/tone (“bUZ”) sound for a period of 5-seconds at the end of each “Guard On Time” cycle.

Free Dry Mode (FrEE)

The Phase 3 microprocessor controller (computer) can be programmed to run without the insertion of coins. When the Phase 3 microprocessor controller (computer) is set in the “FrEE” dry mode, it reverts to the “AUtO” (Automatic) Mode.

Coin Mode (Coin)

In this program (“Coin”), coins are required to start the dryer, even if the Phase 3 microprocessor controller (computer) is set in the Automatic Mode.

Flash Display Status (FLS)

When the Phase 3 microprocessor controller (computer) is set in this program status (“FLS”), it allows the L.E.D. readout to display “FILL” (no cycle in progress), and the “Amount To Start” (**PL12**) or, in the case of free dry, “FrEE.” The programming allows the L.E.D. readout to flip-flop back and forth every 2-seconds from “FILL” to “Amount To Start,” or in the case of free dry, from “FILL” to “FrEE.”

Bad Coin Lockout Status (bCLO)

In this program status, the computer counts in milliseconds the amount of time required for a coin entry signal. If someone should tamper with the coin acceptor or attempt to insert a foreign object, the Phase 3 microprocessor controller (computer) will lock up, shut the dryer down, and the display will read "OFF." This condition will be evident, even if coins are inserted, until the program is manually reset by closing and reopening the program switch (PS).

Bad Coin Reset (bCrS)

When set in this program ("bCrS"), the Phase 3 microprocessor controller (computer) counts in milliseconds the amount of time required for a coin entry signal. If someone should tamper with the coin acceptor or attempt to insert a foreign object, the Phase 3 microprocessor controller (computer) will not accept the entry and will automatically reset itself immediately for the next entry.

Accumulative Time (AtIn)

Single Coin

In this program mode ("AtIn"), each coin inserted has a specific value in time, which is determined by the "Time Per Left Coin" ("tPLC") program (**PL11**).

Example No. 1: If the dryer is equipped with a 25¢ coin acceptor and the desired time is 12 minutes, each additional coin inserted would yield 12 minutes.

Settings: PL09 (LCdE) 25
 PL11 (tPLC) 12
 PL12 (AtSt) 25

Example No. 2: If the dryer is equipped with a 25¢ coin acceptor and the "Amount To Start" ("AtSt") is 50¢ for 30 minutes, the insertion of each additional coin would yield 15 minutes. In this application the "Time Per Left Coin" ("tPLC") is determined by dividing the "Total Vend Time" (30) by the "Amount To Start" ("AtSt") (i.e. 50¢) and then, multiplying by the Left Coin Denomination ("LCdE").

Formula: (Total Vend Time/AtSt)(LCdE) = tPLC
(30/50)(25) = 15 minutes

Settings: PL09 (LCdE) 25
 PL11 (tPLC) 15
 PL12 (AtSt) 50

Dual Coin

In the time accumulation mode, when using a dual coin acceptor, once the “Amount To Start” (“AtSt”) has been inserted, the addition of a coin(s) yields more time. The amount of time accumulated for each additional coin inserted is determined by the “Time Per Left Coin” (“tPLC”) program (**PL11**).

The “Time Per Left Coin” (“tPLC”) is determined by taking the “Total Vend Time” divided by the “Amount To Start” (“AtSt”) (**PL12**) and then, multiplying by the “Left Coin Denomination” (“LCdE”).

Formula: (Total Vend Time/AtSt)(LCdE) = tPLC

Example No. 1: Using a 10¢/25¢ dual coin acceptor with the desired “Amount To Start” (“AtSt”) being 25¢ for 15 minutes, each additional 10¢ would yield 6 minutes:

Formula: (15/25)(10) = 6 minutes (tPLC)

Settings: **PL09 (LCdE)** 10
PL10 (rCdE) 25
PL11 (tPLC) 6
PL12 (AtSt) 25

Example No. 2: If the dryer is equipped with a 10¢/25¢ dual coin acceptor and the “Amount To Start” (“AtSt”) is 35¢ for 14 minutes, each additional 10¢ inserted would yield 4 minutes, and each additional 25¢ would yield 10 minutes.

Formula: (14/35)(10) = 4 minutes (tPLC)

Settings: **PL09 (LCdE)** 10
PL10 (rCdE) 25
PL11 (tPLC) 4
PL12 (AtSt) 35

Example No. 3: If the dryer is equipped with a 10¢/25¢ dual coin acceptor and the desired “Amount To Start” (“AtSt”) is 55¢ for 33 minutes, each additional 10¢ inserted would yield 6 minutes, and each additional 25¢ would yield 15 minutes.

Formula: (33/55)(10) = 6 minutes (tPLC)

Settings: **PL09 (LCdE)** 10
PL10 (rCdE) 25
PL11 (tPLC) 6
PL12 (AtSt) 55

NOTE: If the Total Vend Time cannot be divided evenly by the “Amount To Start” (“AtSt”), the “Time Per Left Coin” (“tPLC”) *must be* rounded off.

Formula: (33/55)(10) = 6.36 - Round off to 6 minutes.

Accumulative Coin (ACOn)

When this program mode (“ACOn”) is selected, additional time can only be achieved when the “Amount For Additional Time” (“AFAt”) (**PL13**) has been inserted.

Single Coin Acceptor

Example No. 1: Using a 25¢ coin acceptor with the desired “Amount To Start” (“AtSt”) being 50¢ for 24 minutes, the Phase 3 microprocessor controller (computer) would yield more time (24 minutes) only when an additional 50¢ is inserted. For this application, the “Time Per Left Coin” (“tPLC”) program (**PL11**) is determined as follows:

Formula: $(\text{Total Vend Time}/\text{AtSt})(\text{LCdE}) = \text{tPLC}$
 $(24/50)(25) = 12 \text{ minutes (tPLC)}$

Settings: **PL09 (LCdE)** **25**
PL10 (rCdE) **12**
PL11 (tPLC) **50**
PL12 (AtSt) **50**

Dual Coin Acceptor

With dual coin acceptor the “Time Per Left Coin” (“tPLC”) is determined as follows:

Formula: $(\text{Total Vend Time}/\text{AtSt})(\text{LCdE}) = \text{tPLC}$

Example No. 1: Using a 10¢/25¢ dual coin acceptor and the desired “Amount To Start” (“AtSt”) is 50¢ for 20 minutes and the “Amount For Additional Time” (“AFAt”) is set for 20¢, each additional 20¢ would yield 8 minutes.

Formula: $(20/50)(10) = 4 \text{ minutes (tPLC)}$

Settings: **PL09 (LCdE)** **10**
PL10 (rCdE) **25**
PL11 (tPLC) **4**
PL12 (AtSt) **50**
PL13 (AFAt) **20**

Example No. 2: If the dryer is equipped with a 10¢/25¢ dual coin acceptor and the “Amount To Start” (“AtSt”) is 35¢ for 14 minutes and the “Amount For Additional Time” (“AFAt”) is set for 25¢, each additional 25¢ inserted would yield 10 minutes.

Formula: $(14/35)(10) = 4 \text{ minutes (tPLC)}$

Settings: **PL09 (LCdE)** **10**
PL10 (rCdE) **25**
PL11 (tPLC) **4**
PL12 (AtSt) **35**
PL13 (AFAt) **25**

PL02 - Dryness Level (drYL)

When in the automatic mode or free dry mode, the dryer will run until the preset level of dryness (Number of Auto Peaks) has been reached. The dryness level is programmable from a minimum of 1 to a maximum of 99.

NOTE: Due to humidity, atmospheric pressure, water retention in the garment etc., the desired dryness level may vary. It is suggested that the owner determine which level of dryness is best suited for his application by experimenting with a few test loads.

PL03 - High Temperature (HI°F)

The high operating temperature is programmable from a minimum of 100° F (38° C) to a maximum of 190° F (88° C) in ten-degree increments or from a minimum of 35° C (95° F) to a maximum of 90° C (194° F) in five-degree increments.

PL04 - High Cool Down Temperature/Time (HICd)

The first part of this program controls the cool down temperature when the Phase 3 microprocessor controller (computer) is used in the automatic or free dry mode. The cool down temperature is programmable from a minimum of 100° F (38° C) to a maximum of 190° F (88° C) in ten-degree increments or from a minimum of 35° C (95° F) to a maximum of 90° C (194° F) in five-degree increments.

The second part of this program controls the cool down time for both the automatic and timed modes. The cool down time can be programmed from a minimum of 0 minutes to a maximum of 9 minutes.

NOTE: When the Phase 3 microprocessor controller (computer) is used in the automatic or free dry mode, at the end of the drying cycle, the Phase 3 microprocessor controller (computer) then starts the automatic cooling cycle for the cool down time programmed or until the temperature has dropped to the programmed cool down temperature, whichever of the two (2) comes first.

PL05 - Low Temperature (LO°F)

Same as **PL03** but for Low Temperature program.

PL06 - Low Cool Down Temperature/Time (LOCd)

Same as **PL04** but for Low Cool Down Temperature/Time.

PL07 - Permanent Press (PP°F)

Same as **PL03** but for Permanent Press.

PL08 - Perm Press Cool Down Temperature/Time (PPCd)

Same as **PL04** but for Permanent Press Cool Down Temperature/Time.

PL09 - Left Coin Slot Denomination (LCdE)

In the case of a single coin acceptor, this program setting is determined by the value of the coin acceptor (i.e., 25¢).

When a dual coin acceptor is used, this program setting is determined by the left coin slot acceptor value (lower coin value). Program settings are from a minimum of 1 to a maximum of 9999.

PL10 - Right Coin Slot Denomination (rCdE)

This program needs only to be set when a dual coin acceptor is used. The program setting is determined by the value of the right coin acceptor slot (higher value). Program settings are from a minimum of 1 to a maximum of 9999. When used in conjunction with the Left Coin Slot Denomination program, the Phase 3 microprocessor controller (computer) automatically calculates the ratios necessary for coin insertion time values.

PL11 - Time Per Left Coin (tPLC)

This program sets a specific value in time for each coin inserted. In the case of a dual coin acceptor, the Time Per Right Coin is automatically calculated by the left and right coin slot denomination ration.

PL12 - Amount To Start (AtSt)

This program sets the “Amount To Start” the dryer and can be programmed from a minimum of 1 to a maximum of 9999.

PL13 - Minimum Amount For Additional Time (AFAt)

This program needs only be set when the Phase 3 microprocessor controller (computer) is set in the “Accumulative Coin” (“ACOn”) mode (**PL01**). The value set for this program is what will have to be inserted for more time after the “Amount To Start” (“AtSt”) has been inserted.

Example No. 1: “Amount To Start” (“AtSt”) is 50¢ for 30 minutes and an additional 50¢ is required for more time. In this example, **PL13 should be** set for 50¢.

PL14 - Maximum Automatic Dryness Time (Adrt)

This program is used only when the Phase 3 microprocessor controller (computer) is set in the automatic mode or free dry mode. This program controls the maximum time the dryer will run even if the Dryness Level program (**PL02**) has not been reached.

PL15 - Antiwrinkle Timing

1. Guard Delay Time (GdLY)

This program controls the dwell (stop) time and activation of the antiwrinkle “Guard On Time” (“Gont”). The dwell (stop) time can be programmed from a minimum of 1 minute to a maximum of 9 minutes in 1 minute increments.

2. Guard On Time (Gont)

This setting controls the amount of time that the basket (tumbler) will turn, without heat, when the antiwrinkle is active (“Grd”). The “Guard On Time” (“Gont”) is programmable from a minimum of 1-second to a maximum of 99-seconds in 1-second increments.

PL16 - Active Guard Time (AGt)

This program controls the maximum time that the Antiwrinkle Program will be active and is programmable from a minimum of 1 minute to a maximum of 99 minutes in 1 minute increments.

SECTION VI

INTRODUCTION TO PROGRAMMING

ALL programming is done through the keyboard (touch pad) selection buttons on the front of the control panel. To change programs or to put the computer in the temperature or coin count display modes, the program switch (PS) located on the back side of the computer **must be** put into the closed position (PSC).

The following instructions explain how to enter the program locations:

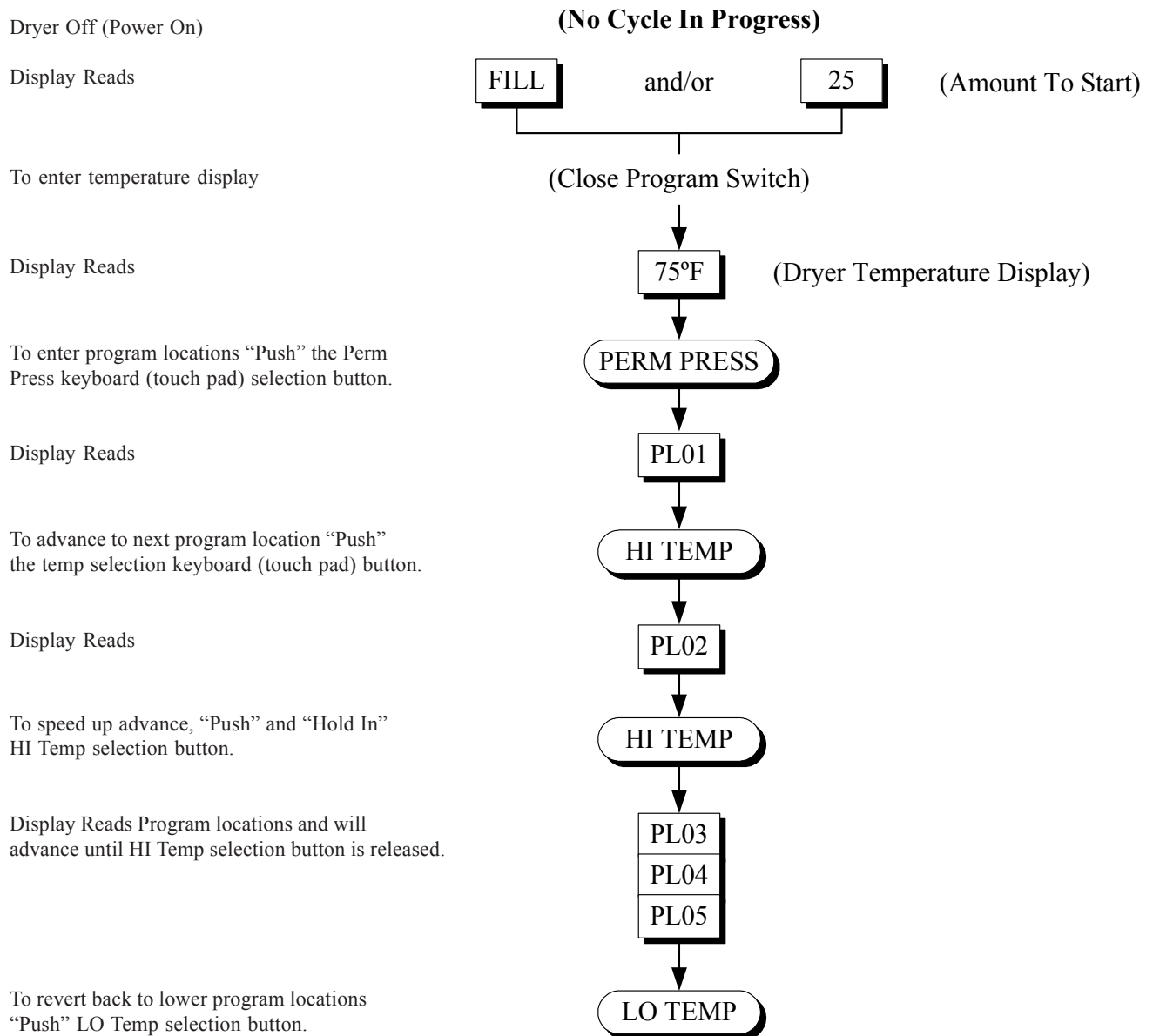

Display Reads

To speed up, “Push” and “Hold In” LO Temp selection button.

Display reads program locations and will advance downward until LO Temp selection button is released.

To enter a specific program location (i.e. **PL01**) “Push” the Perm Press selection button.

Display Will Read specific program location called up.

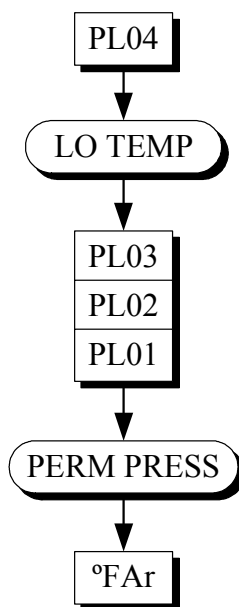

(Example)

SECTION VII

PROGRAMMING

A. TEMPERATURE DISPLAY MODE

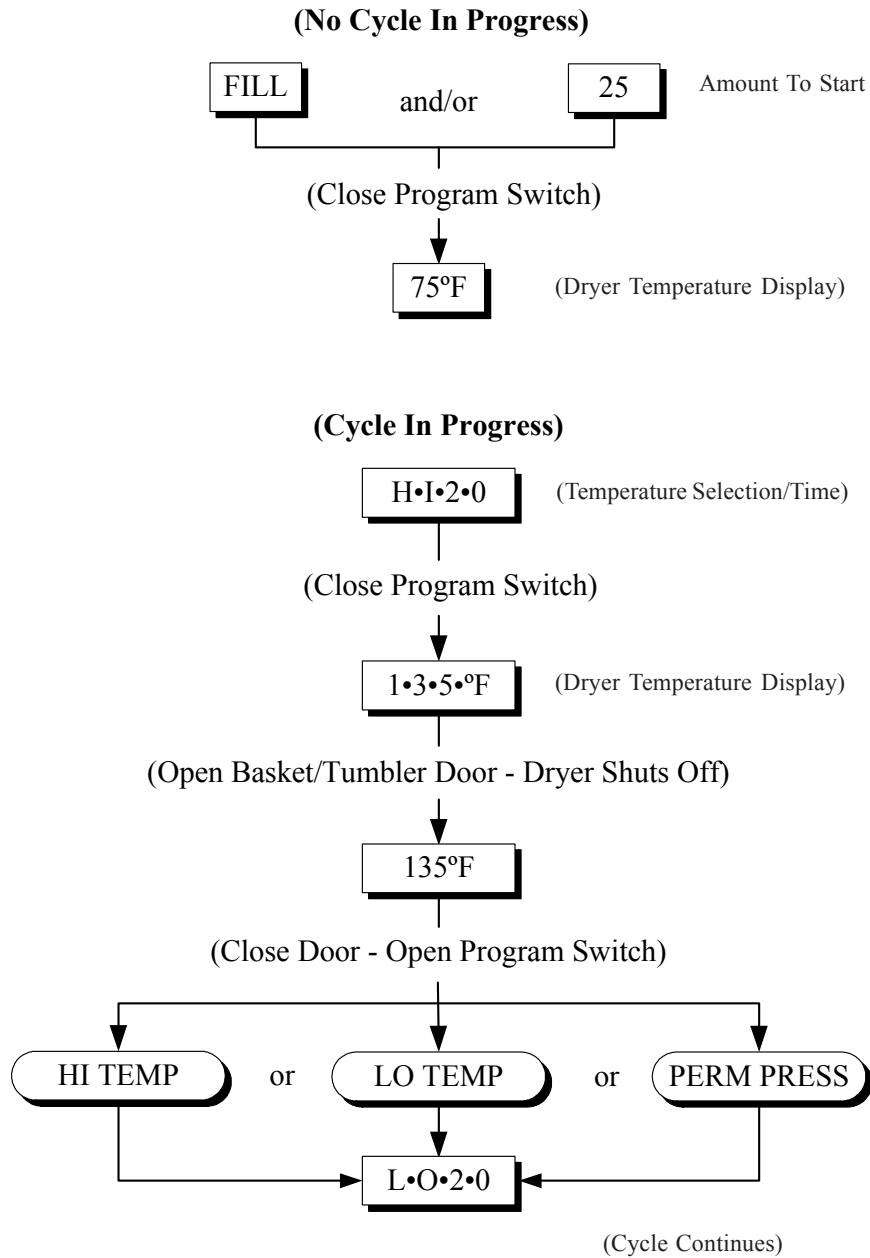

B. RIGHT COIN COUNT (rCC)

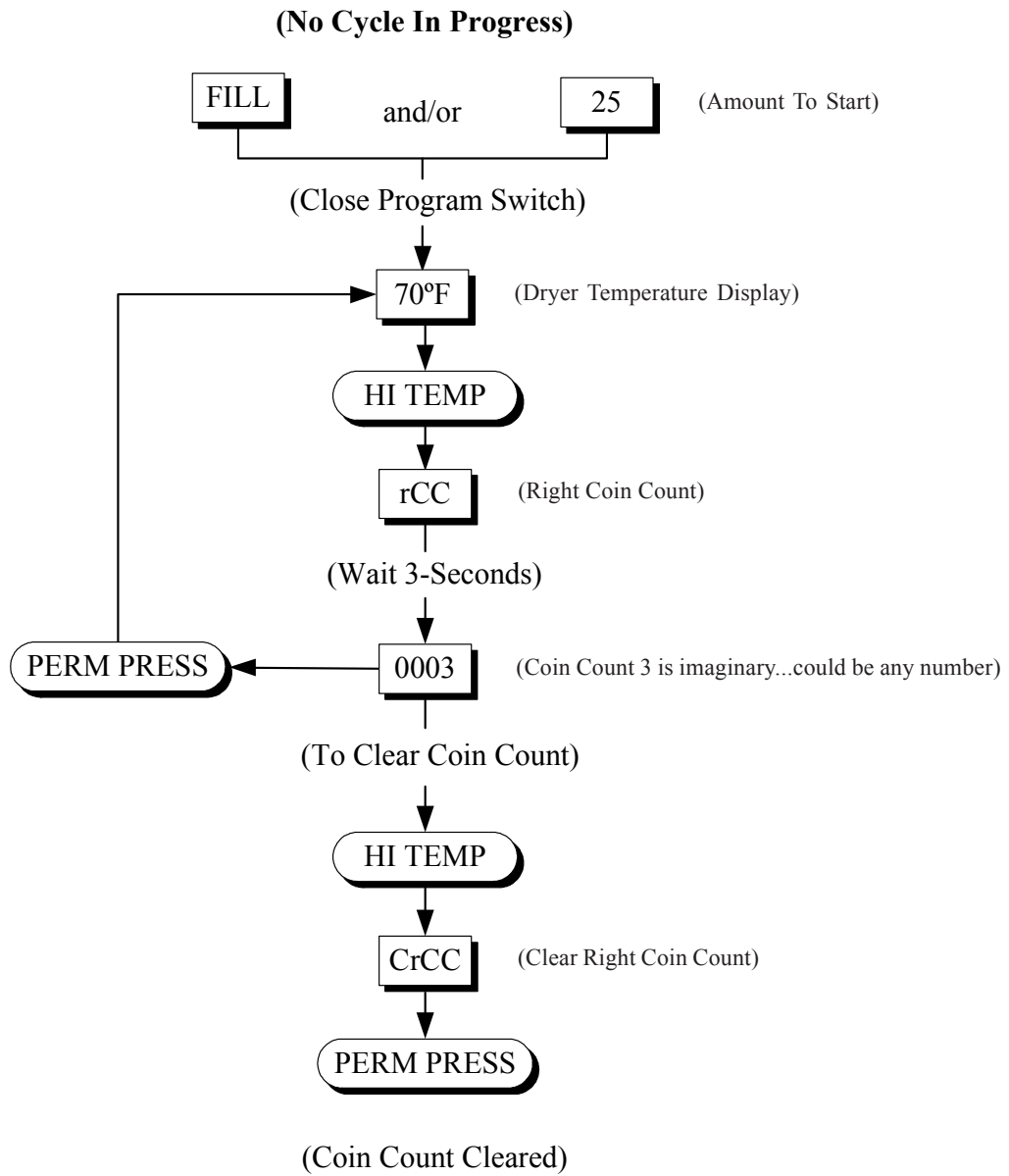

(Open program switch [PS] to exit out of display mode)

C. LEFT COIN COUNT (LCC)

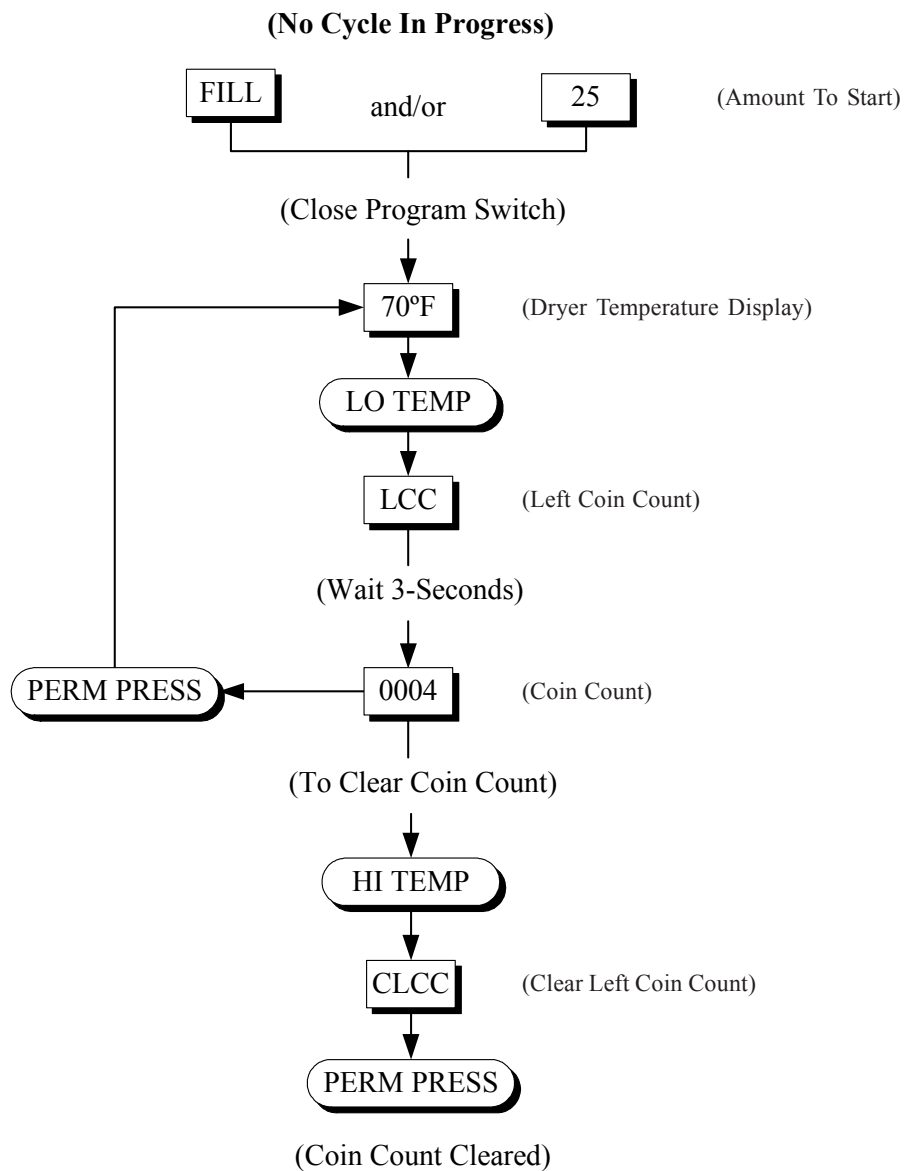

(Open program switch [PS] to exit out of display mode)

D. PROGRAM LOCATION 01 (PL01)

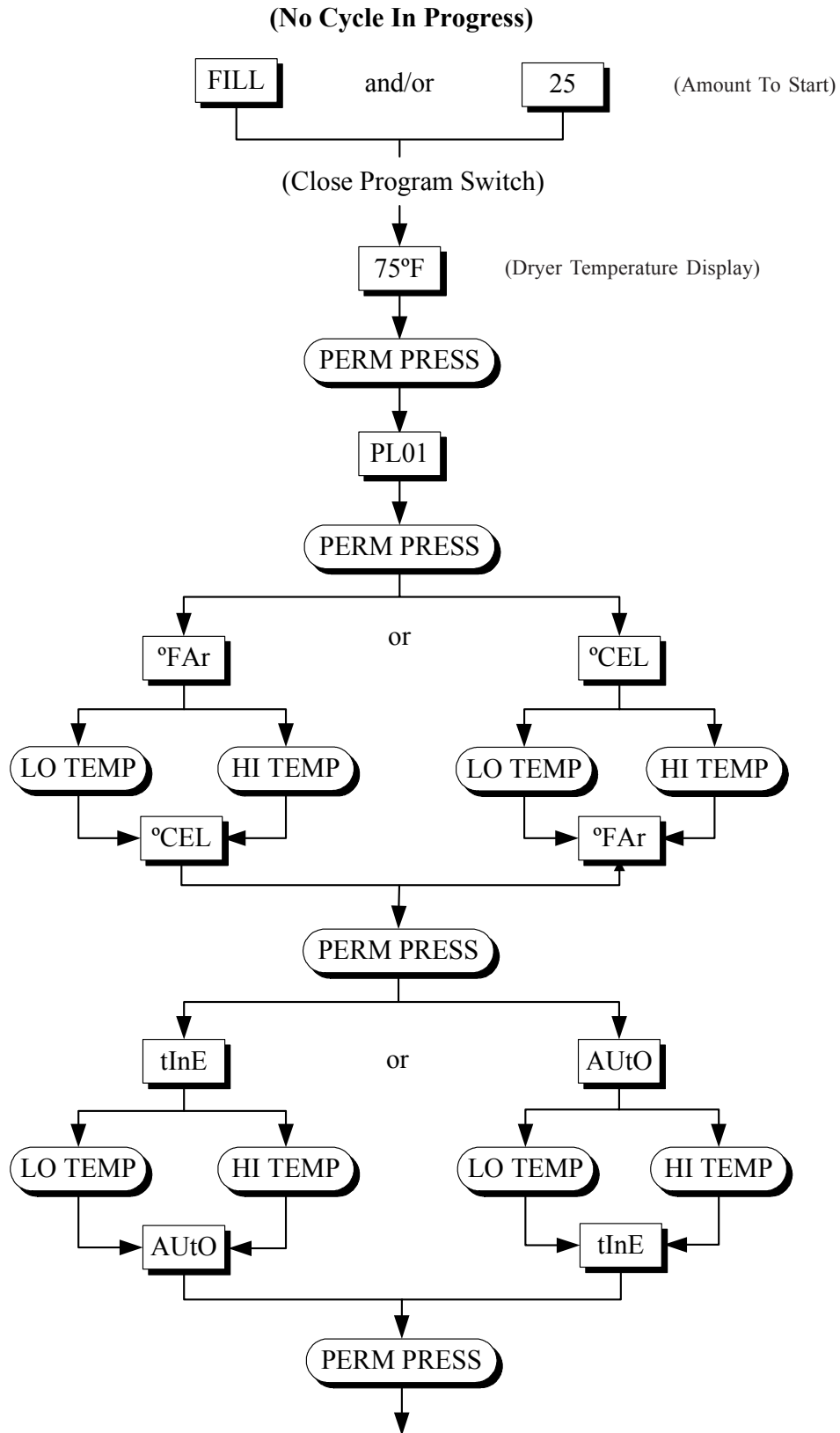

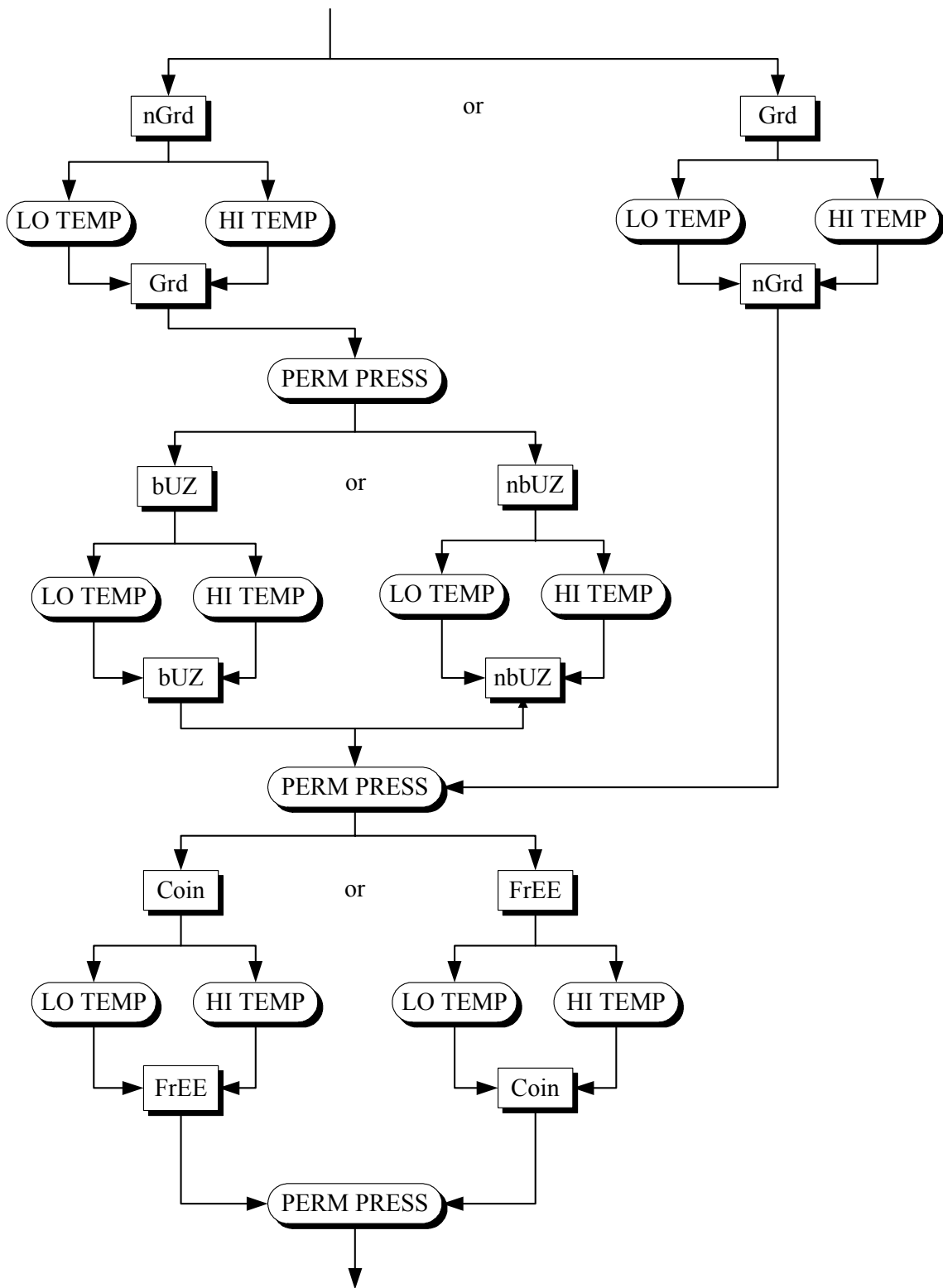

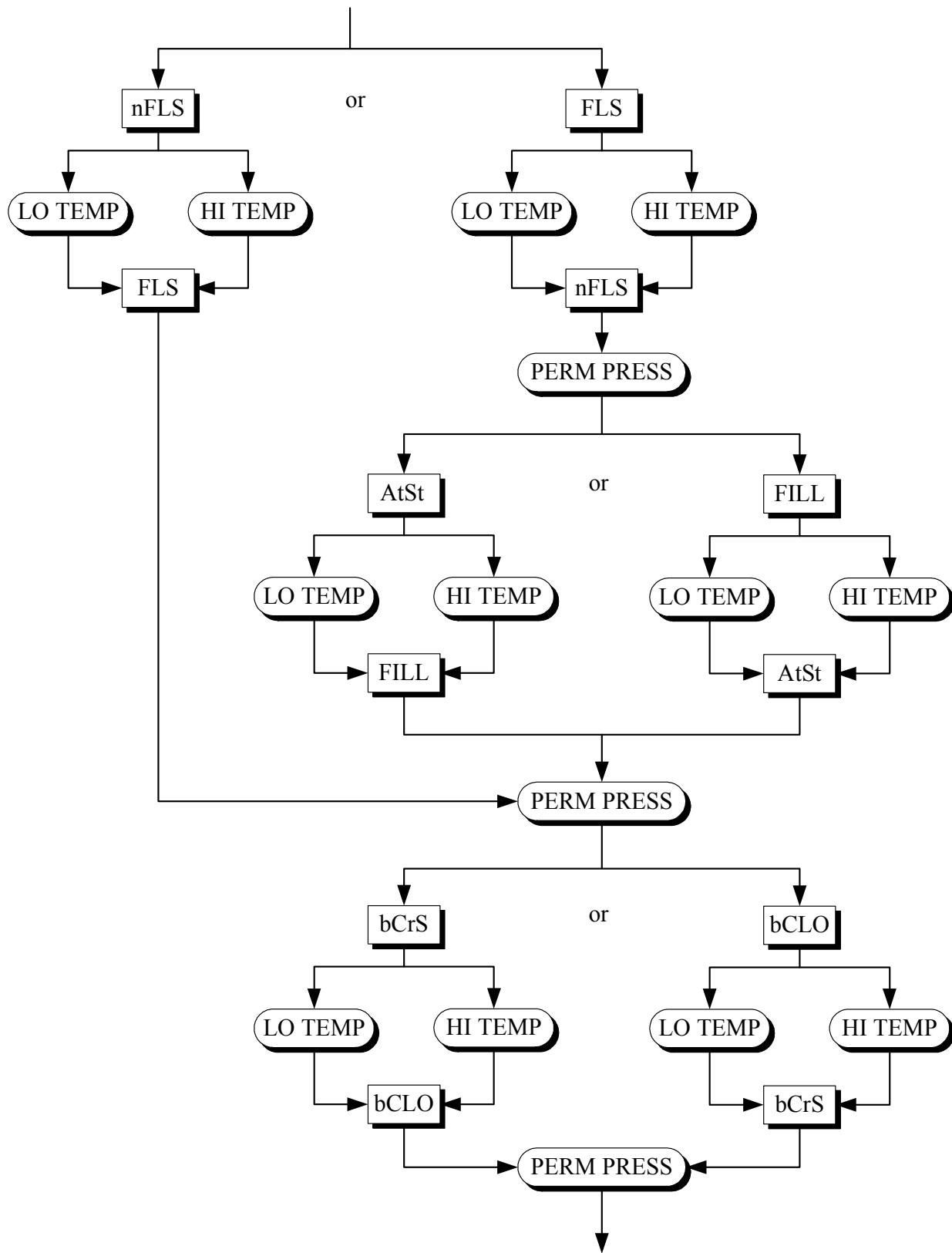

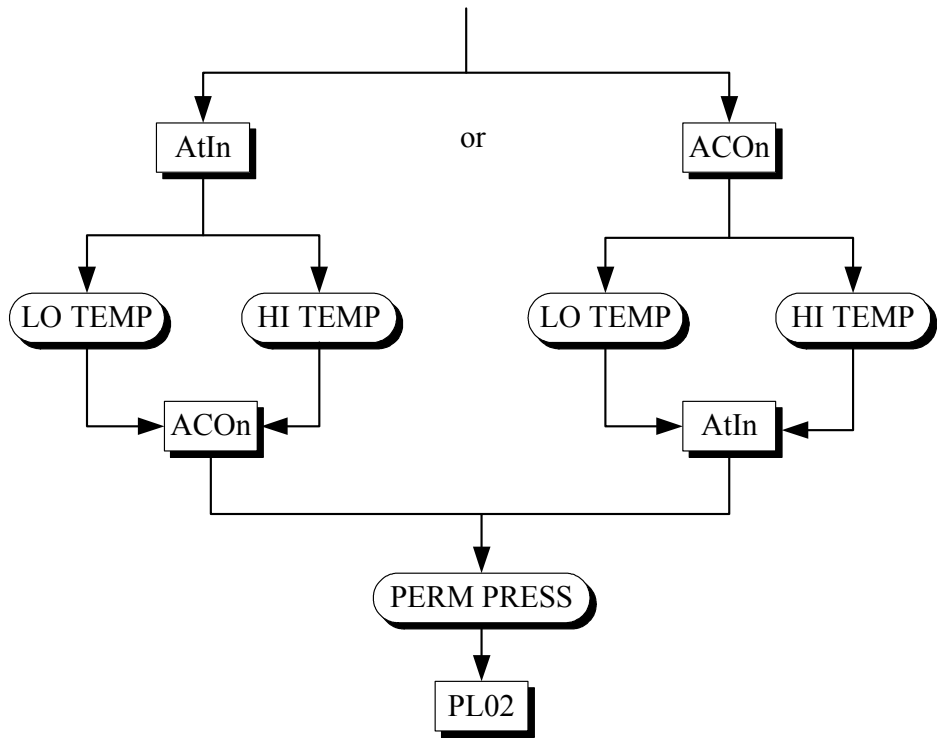

E. PROGRAM LOCATION 02 (PL02)

Number of Auto Peaks (Dryness Level)

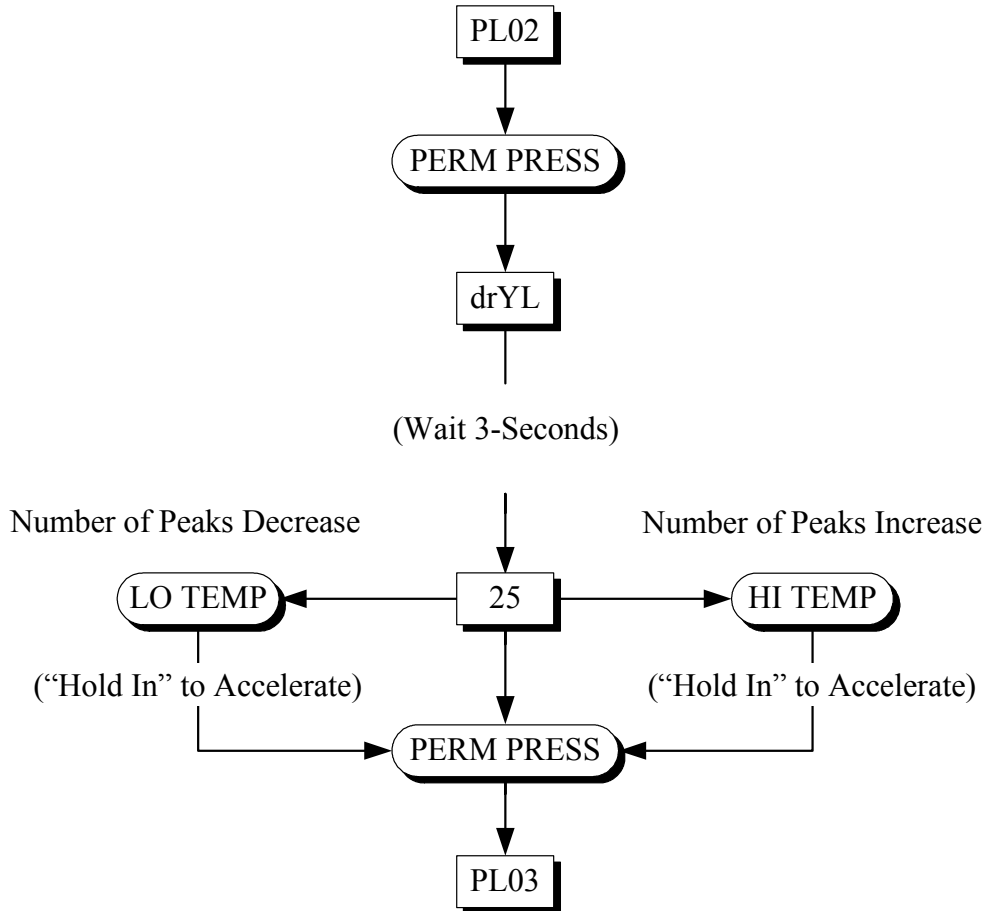

Summary: The dryness level is programmable from a minimum of 1 to a maximum of 99.

F. PROGRAM LOCATION 03 (PL03)

HI temp

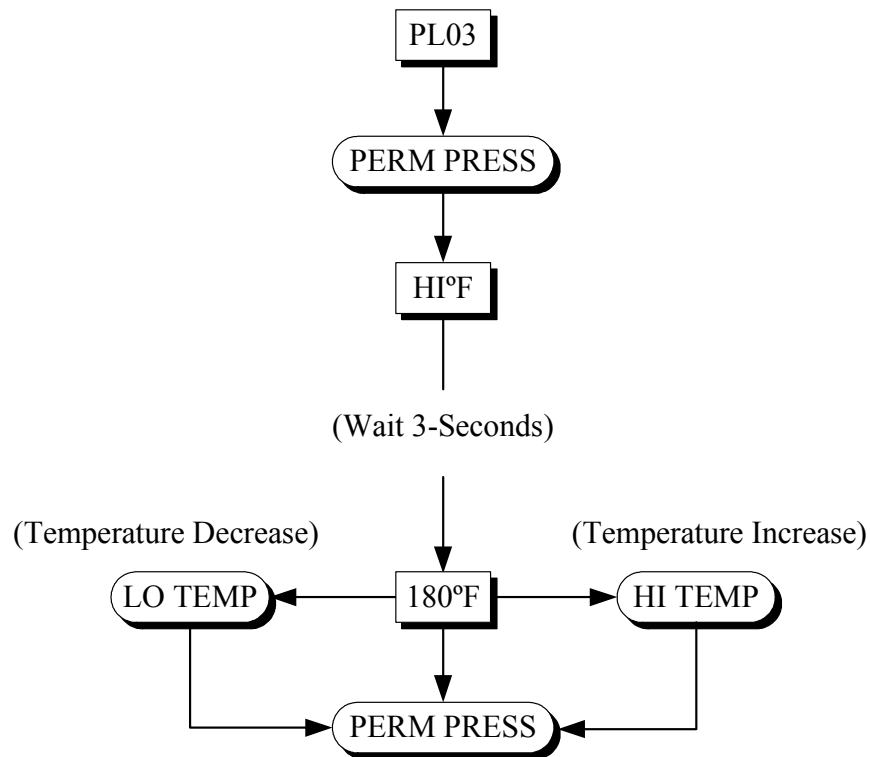

(Automatically goes into PL04 Program without PL04 Display Mode)

Summary: HI temp is programmable from a minimum of 100° F (38° C) to a maximum of 190° F (88° C) in ten-degree increments or from a minimum of 35° C (95° F) to a maximum of 90° C (194° F) in five-degree increments.

G. PROGRAM LOCATION 04 (PL04)

HI Temp Cool Down Temperature/Time

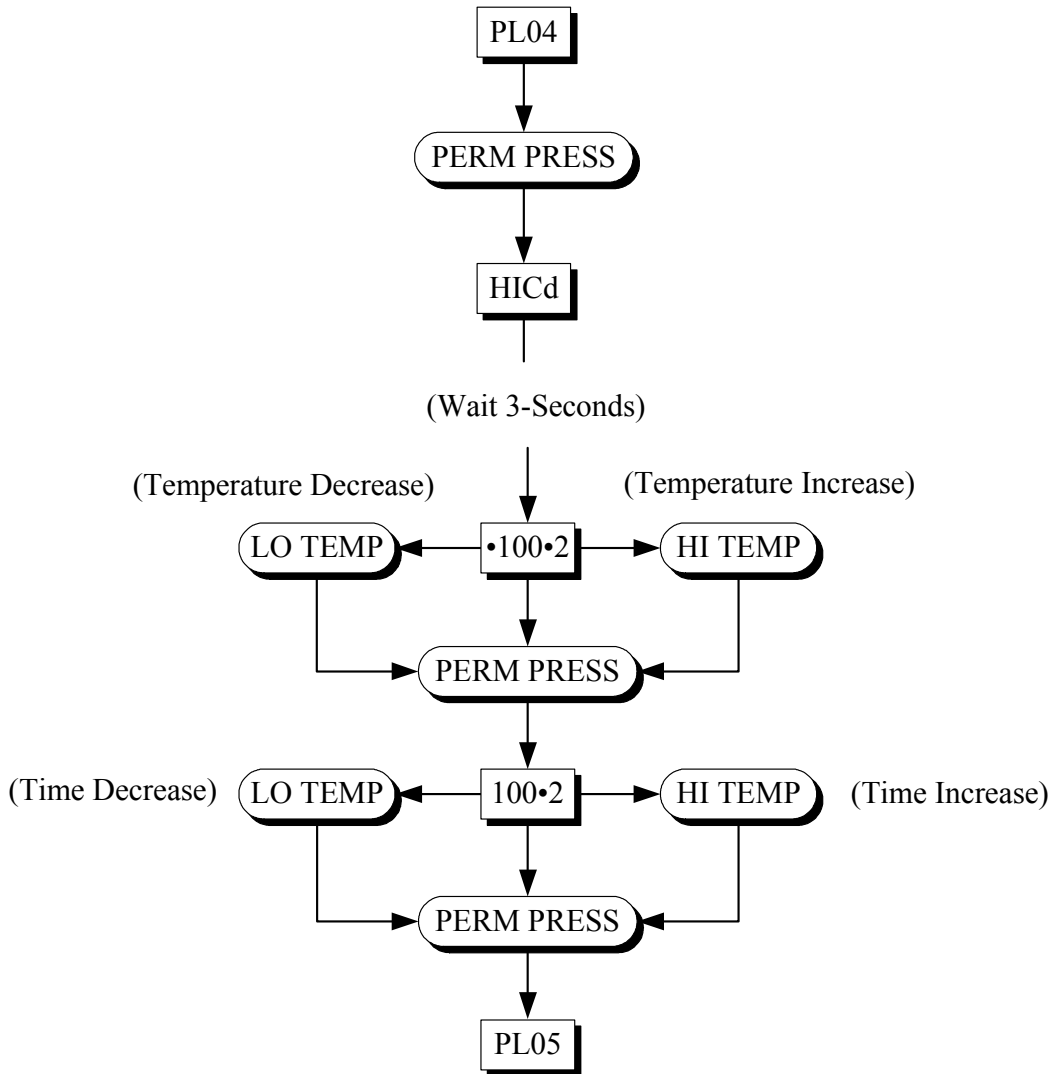

Summary: Cool down temperature is programmable from a minimum of 100° F (38° C) to a maximum of 190° F (88° C) or from 35° C (95° F) to a maximum of 90° C (194° F). Cool down time is programmable from 0 to 9 minutes.

H. PROGRAM LOCATION 05 (PL05)

LO temp

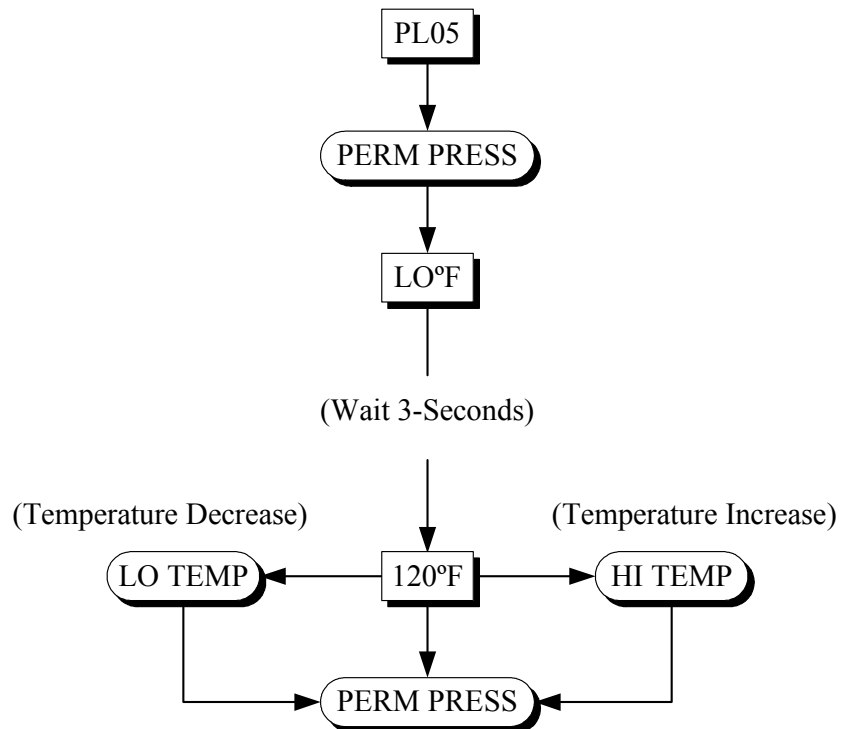

(Automatically goes into PL06 Program without PL06 Display Mode)

Summary: LO temp is programmable from a minimum of 100° F (38° C) to a maximum of 190° F (88° C) in ten-degree increments or from a minimum of 35° C (95° F) to a maximum of 90° C (194° F) in five-degree increments.

I. PROGRAM LOCATION 06 (PL06)

LO Temp Cool Down Temperature/Time

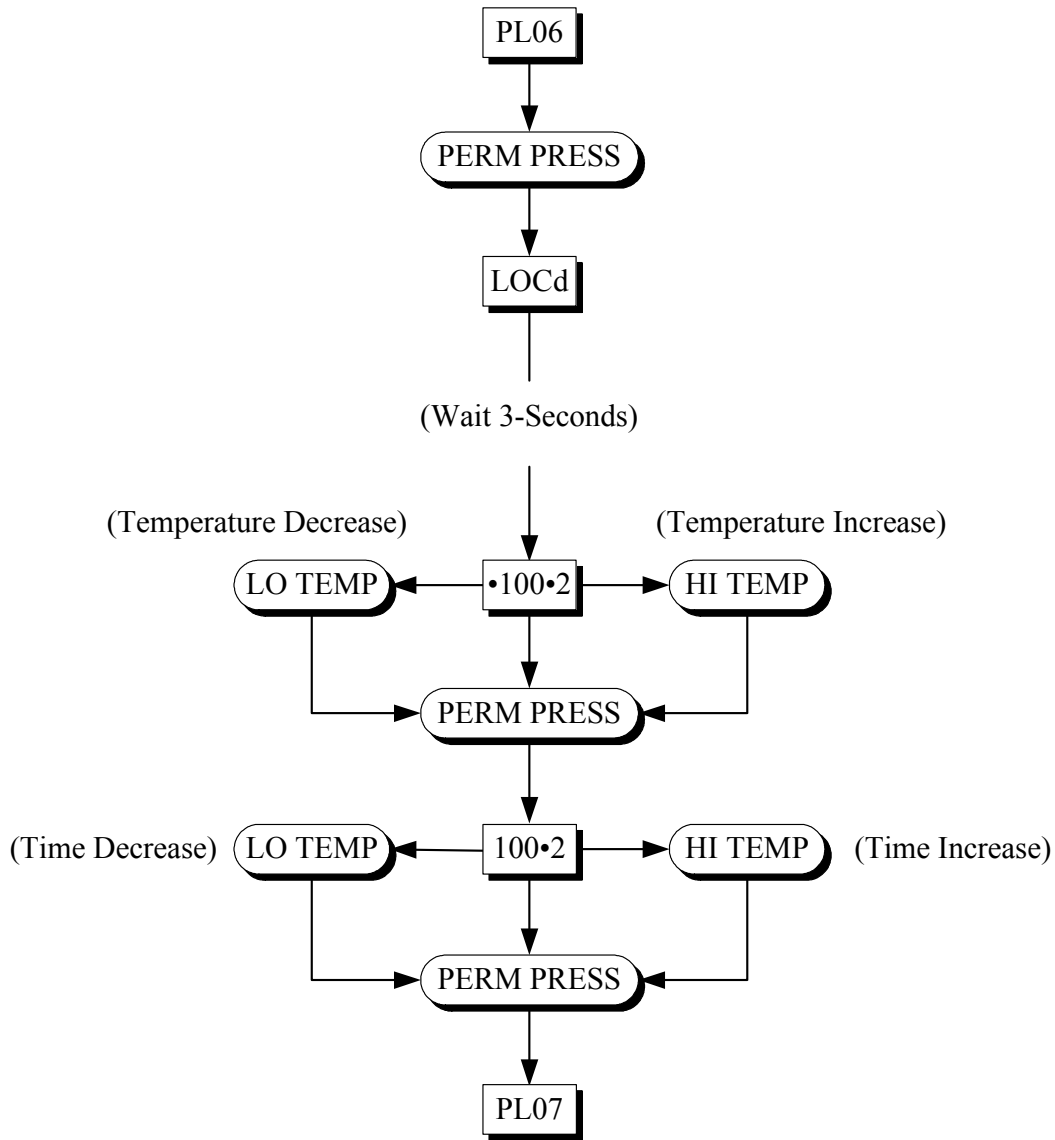

Summary: Cool down temperature is programmable from a minimum of 100° F (38° C) to a maximum of 190° F (88° C) or from 35° C (95° F) to a maximum of 90° C (194° F). Cool down time is programmable from 0 to 9 minutes.

J. PROGRAM LOCATION 07 (PL07)

Perm Press Temperature

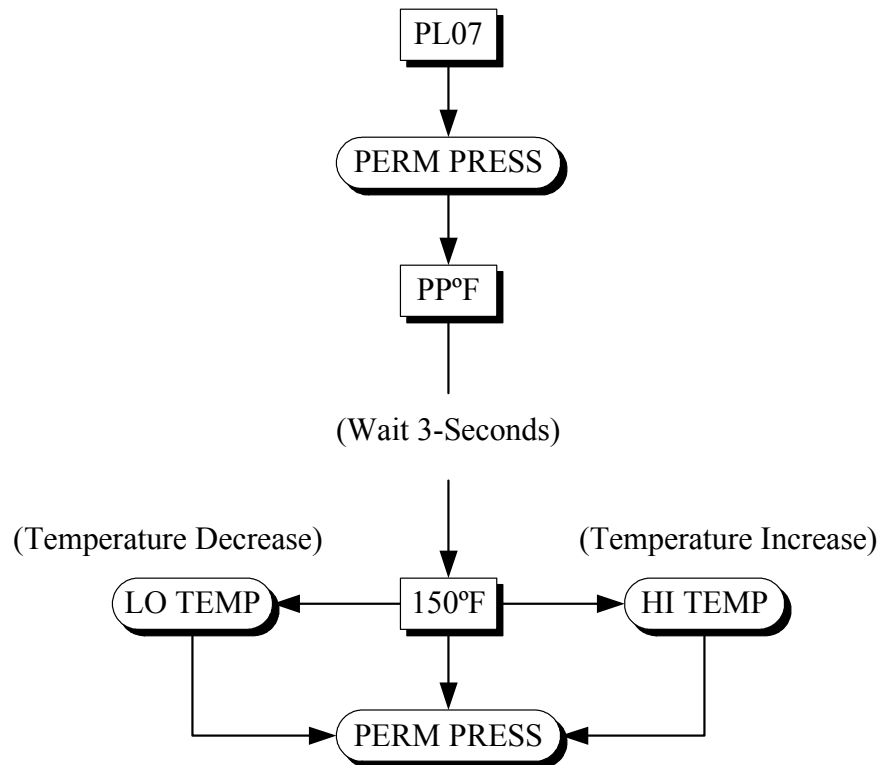

(Automatically goes into PL08 Program without PL08 Display Mode)

Summary: Perm Press is programmable from a minimum of 100° F (38° C) to a maximum of 190° F (88° C) in ten-degree increments or from a minimum of 35° C (95° F) to a maximum of 90° C (194° F) in five-degree increments.

K. PROGRAM LOCATION 08 (PL08)

Perm Press Cool Down Temperature/Time

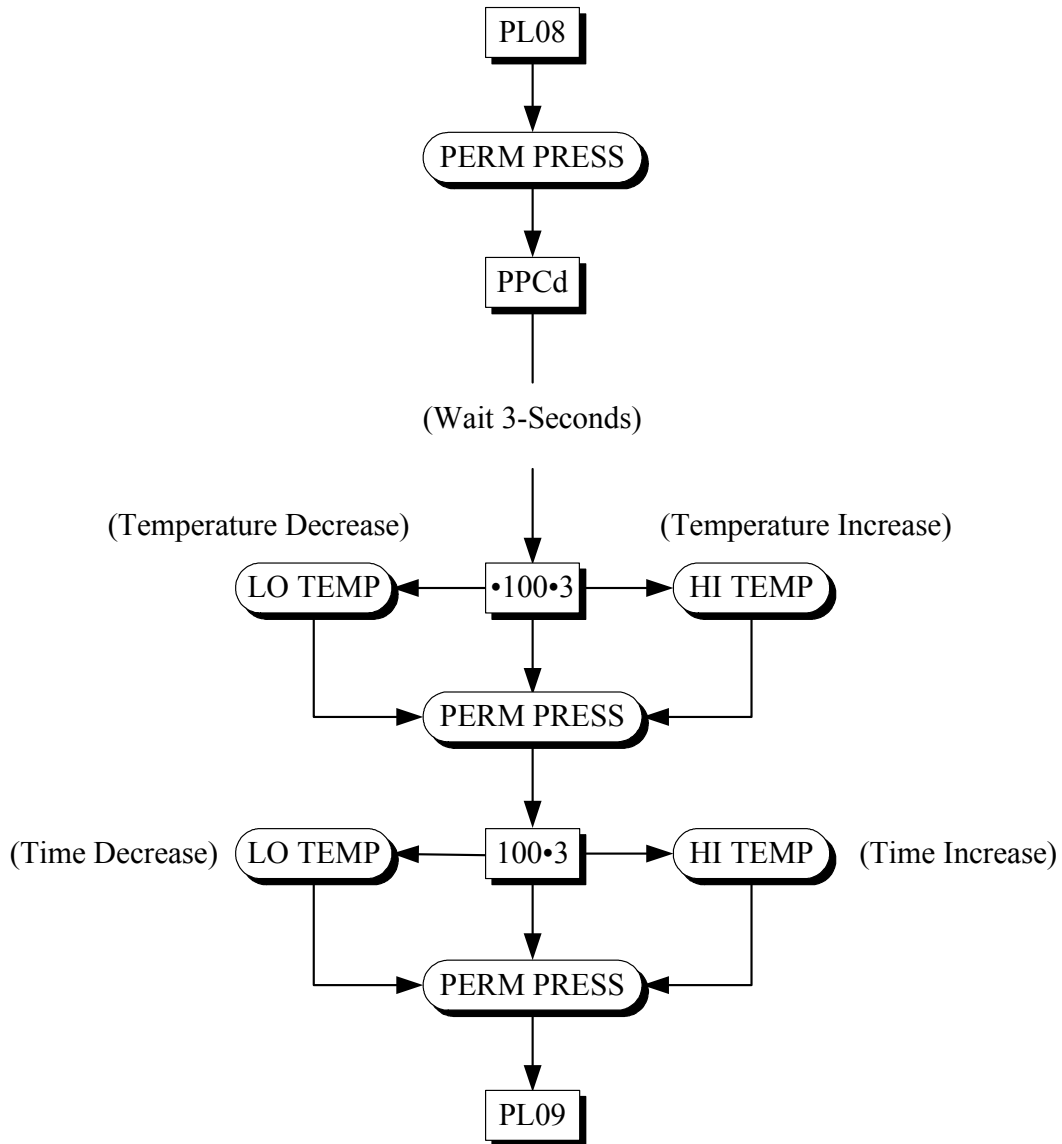

Summary: Cool down temperature is programmable from a minimum of 100° F (38° C) to a maximum of 190° F (88° C) or from 35° C (95° F) to a maximum of 90° C (194° F). Cool down time is programmable from 0 to 9 minutes.

L. PROGRAM LOCATION 09 (PL09)

Left Coin Denomination

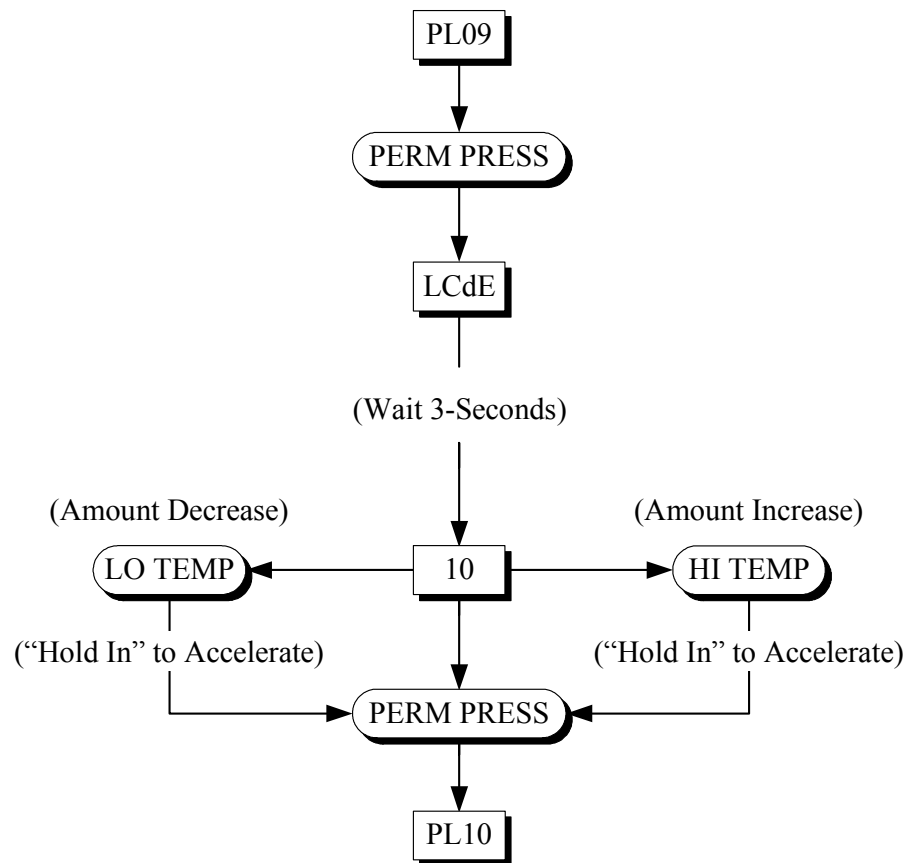

Summary: The left coin denomination is programmable from 1 to 9999.

M. PROGRAM LOCATION 10 (PL10)

Right Coin Denomination

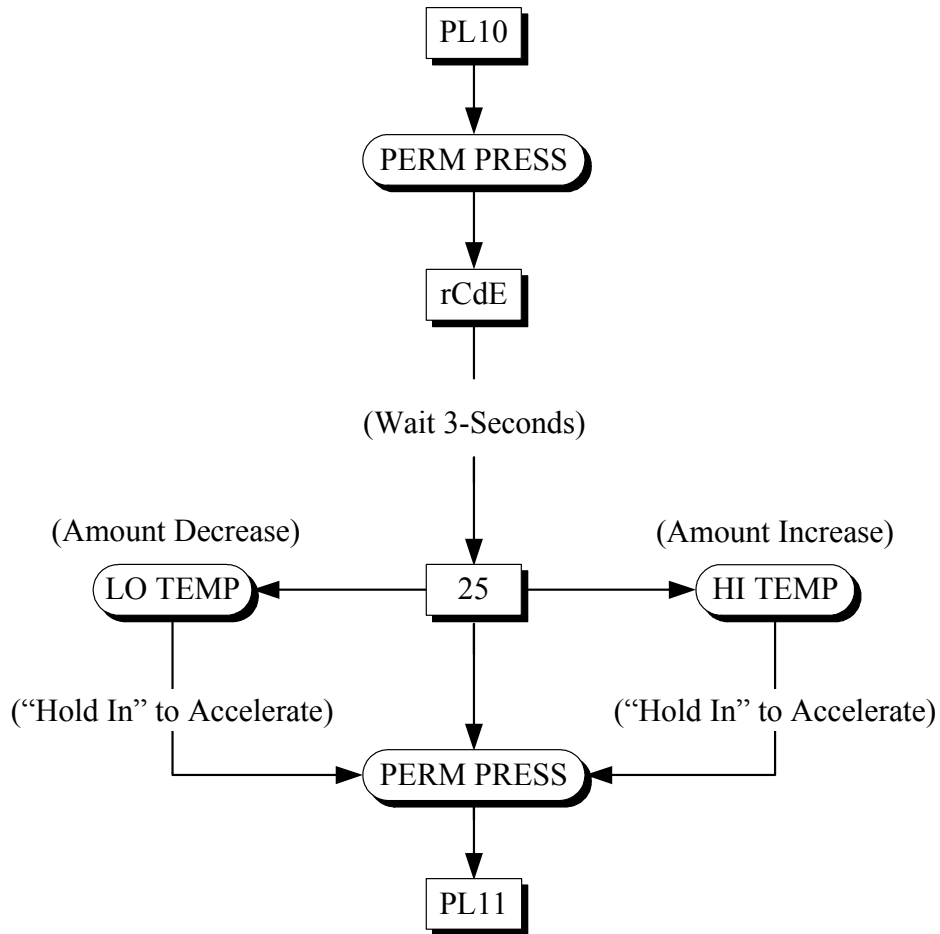

Summary: The right coin denomination is programmable from 1 to 9999.

N. PROGRAM LOCATION 11 (PL11)

Time Per Left Coin

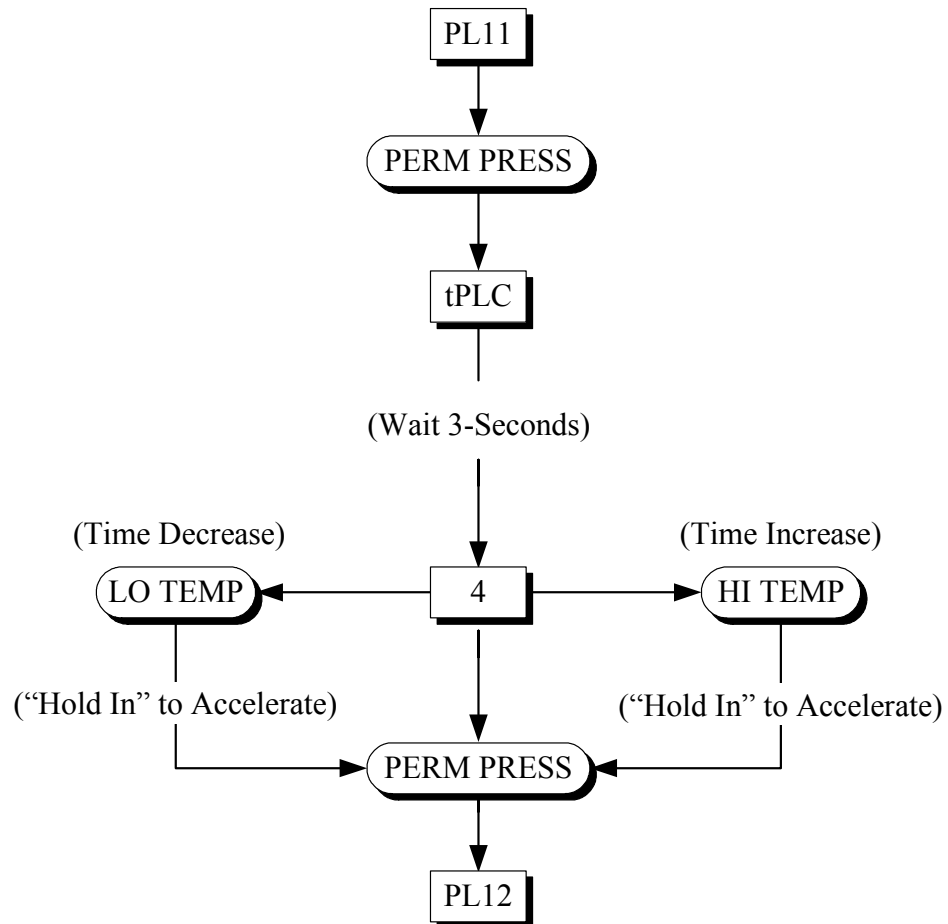

Summary: The time per left coin is programmable from 1 to 99 minutes.

O. PROGRAM LOCATION 12 (PL12)

Amount To Start

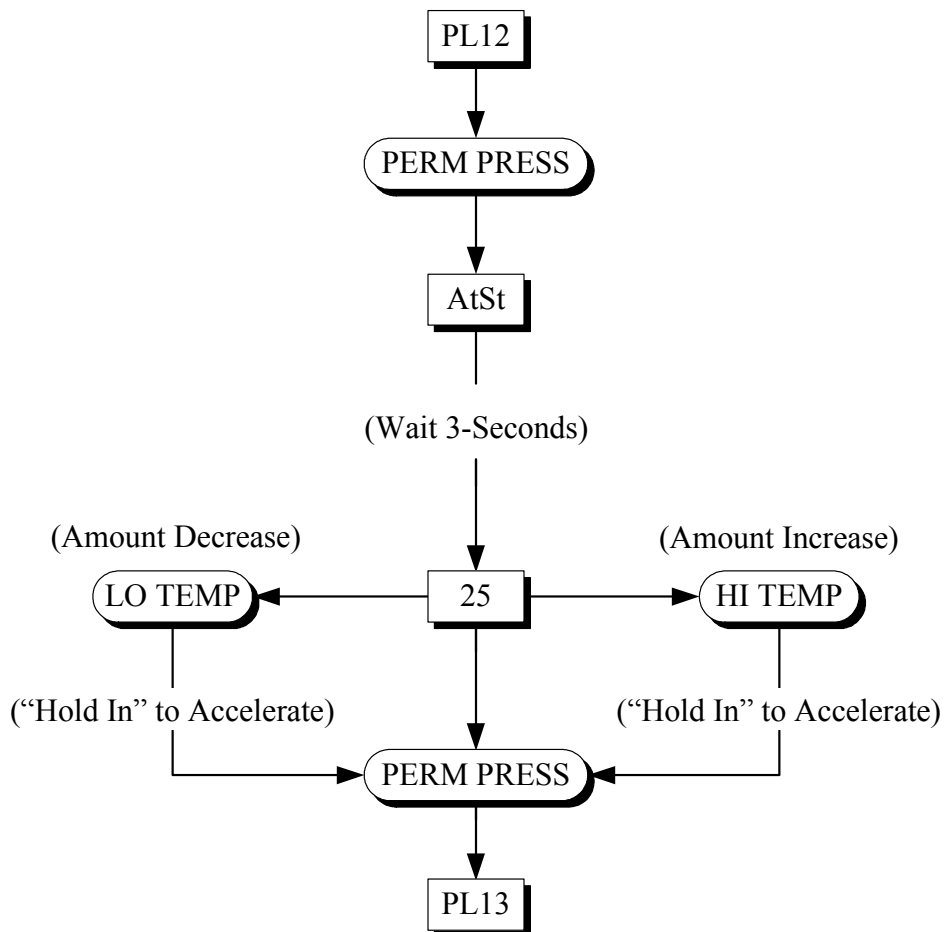

Summary: The amount to start is programmable from 1 to 9999.

P. PROGRAM LOCATION 13 (PL13)

Coin Accumulation Minimum Amount for More Time

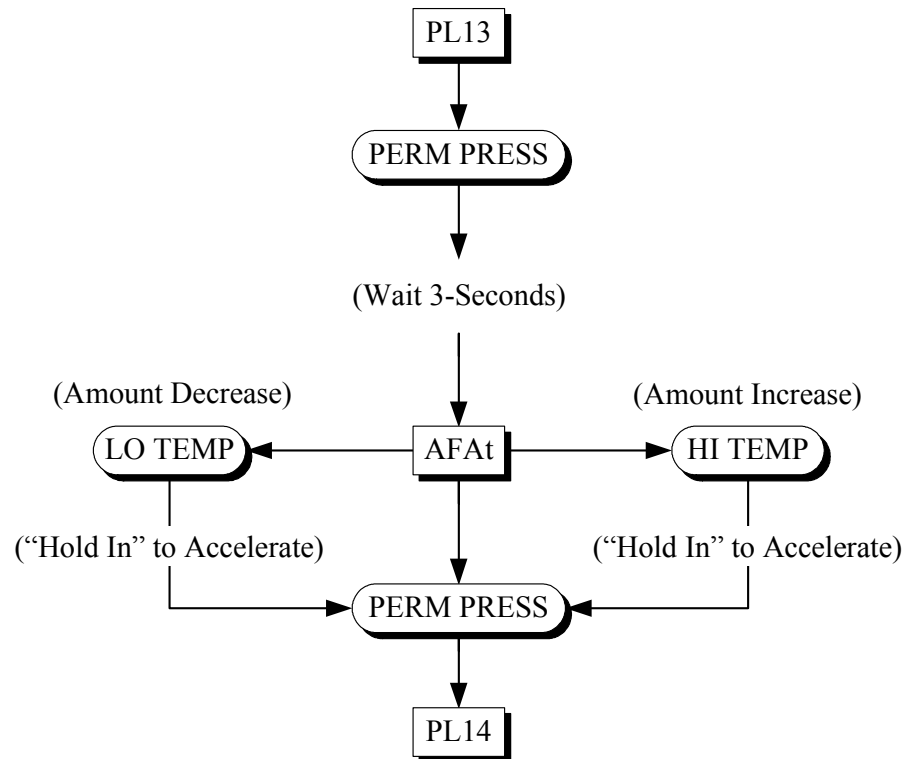

Summary: The amount for additional time is programmable from 1 to 9999.

Q. PROGRAM LOCATION 14 (PL14)

Maximum Time for Auto Dry

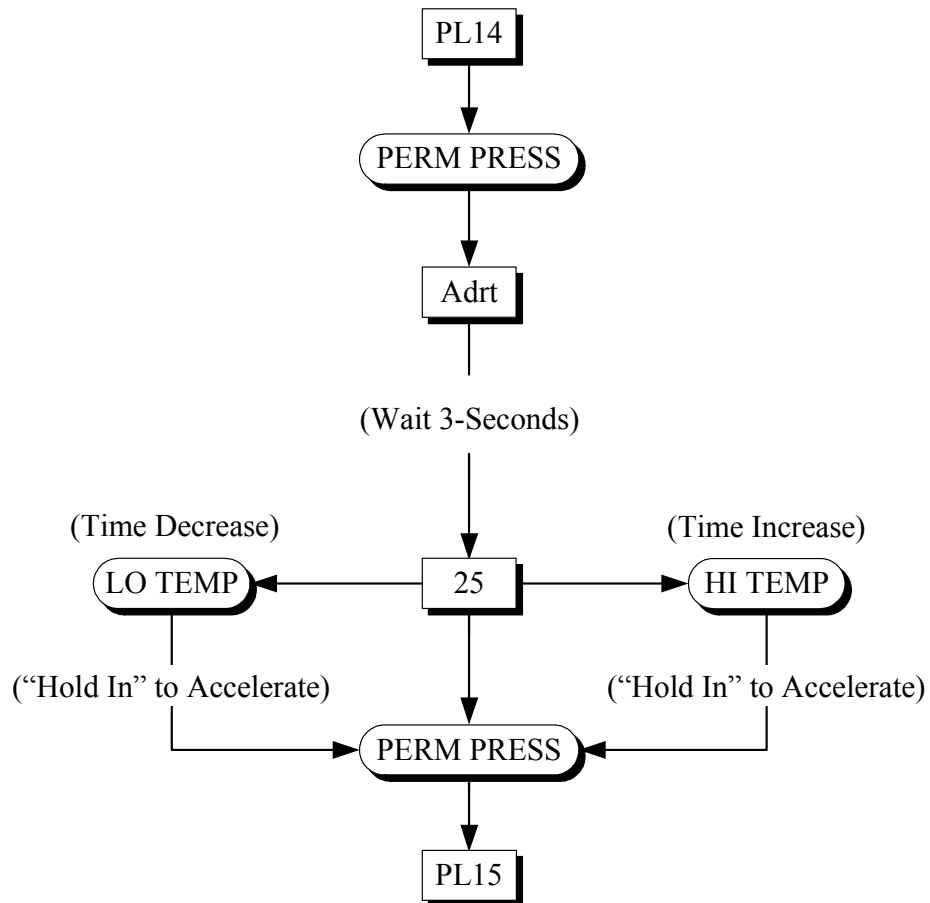

Summary: The maximum auto dryness time is programmable from 1 to 99 minutes.

R. PROGRAM LOCATION 15 (PL15)

Antiwrinkle Timing

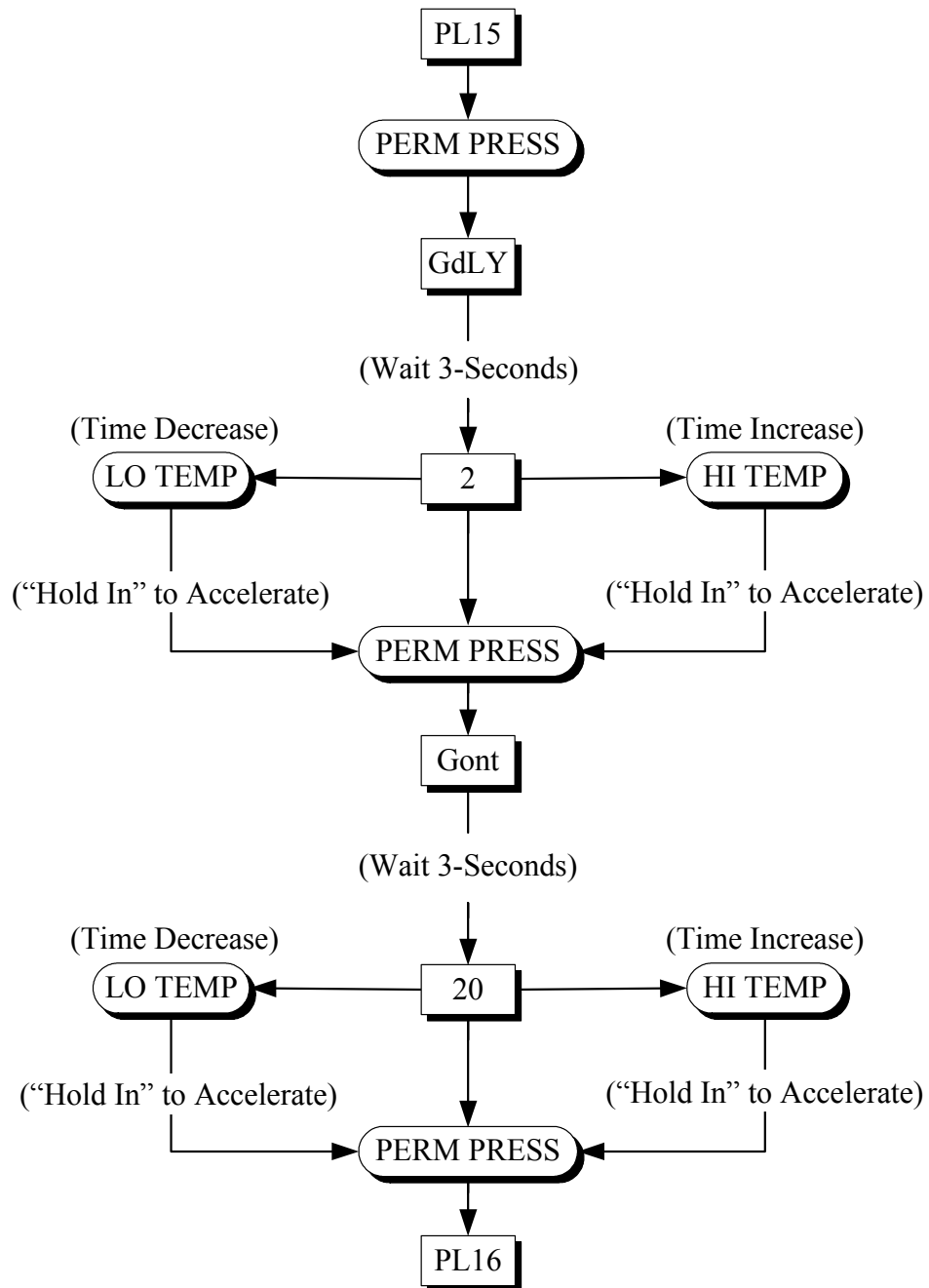

Summary: Guard delay time is programmable from 1 to 9 minutes. Guard on time is programmable from 1 to 99-seconds.

S. PROGRAM LOCATION 16 (PL16)

Maximum Active Antiwrinkle Time

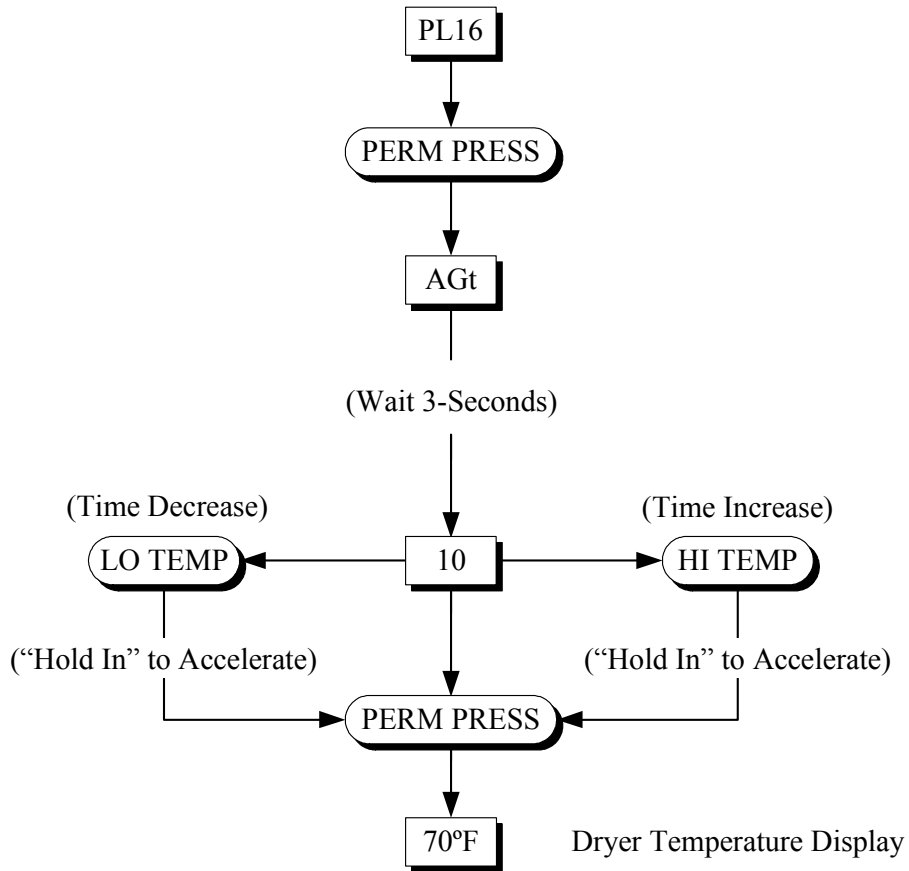

Summary: The maximum active guard time is programmable from 1 to 99 minutes.

SECTION VIII

FACTORY PRESET PROGRAMS

Unless otherwise specified at the time of ordering, the Phase 3 microprocessor controller (computer) has been preprogrammed by the factory with the following parameters. Should changes be found necessary, please read this manual carefully to thoroughly familiarize yourself with the Phase 3 programming characteristics.

Dual Coin		
PL01	°FAr tInE Grd bUZ Coin FLS bCrS AtIn	Temperature in Fahrenheit Timed mode Antiwrinkle guard on Antiwrinkle guard buzzer (tone) on Coin(s) required to start Display will flash in intervals between "FILL" and "Amount To Start" Bad coin reset Accumulative time
PL02	drYL	Dryness level set at 25
PL03	HI° F	180°
PL04	HICd	Temperature - 100° Time - 2 minutes
PL05	LO° F	120°
PL06	LOCd	Temperature - 100° Time - 2 minutes
PL07	PP° F	150°
PL08	PPCd	Temperature - 100° Time - 3 minutes
PL09	LCdE	Left coin denomination - 10
PL10	rCdE	Right coin denomination - 25
PL11	tPLC	Time per left coin - 4 minutes
PL12	AtSt	Amount to start - 25
PL13	AFAt	Amount for additional time - 10
PL14	Adrt	Automatic dry maximum time - 30 minutes
PL15	GdLY Gont	Antiwrinkle guard off delay - 2 minutes Antiwrinkle guard on time - 20-seconds
PL16	AGt	Active Antiwrinkle guard time - 10 minutes

Single Coin Only

PL01	°FAr tInE Grd bUZ Coin FLS bCrS AtIn	Temperature in Fahrenheit Timed mode Antiwrinkle guard on Antiwrinkle guard buzzer (tone) on Coin(s) required to start Display will flash in intervals between "FILL" and "Amount To Start" Bad coin reset Accumulative time
PL02	drYL	Dryness level set at 25
PL03	HI° F	180°
PL04	HICd	Temperature - 100° Time - 2 minutes
PL05	LO° F	120°
PL06	LOCd	Temperature - 100° Time - 2 minutes
PL07	PP° F	150°
PL08	PPCd	Temperature - 100° Time - 3 minutes
PL09	LCdE	Left coin denomination - 25
PL10	rCdE	Right coin denomination - 25
PL11	tPLC	Time per left coin -10 minutes
PL12	AtSt	Amount to start - 25
PL13	AFAt	Amount for additional time - 10
PL14	Adrt	Automatic dry maximum time - 30 minutes
PL15	GdLY Gont	Antiwrinkle guard off delay - 2 minutes Antiwrinkle guard on time - 20-seconds
PL16	AGt	Active Antiwrinkle guard time - 10 minutes

SECTION IX

NON-COIN COMPUTER DRYER

Non-Coin Features

Automatic Operation

The user selects fabric and level of dryness desired. The dryer automatically turns the heat off when the level of dryness has been reached, and goes into cool down for 5 minutes or until a temperature of 100° F (38° C) is reached.

Manual Operation

The user selects drying time and cooling time (up to 99 minutes each) and type of fabric that is being dried.

Nine Fabric Selections

The temperature range is from 110° F (43° C) to 190° F (88° C).

Temperature Display

This feature is available in either Fahrenheit or Celsius.

Troubleshooting

The microprocessor controller (computer) can detect trouble in the door circuit, temperature circuit, motor circuit, and heat circuit.

Audible Tone

A buzzer (tone) will sound for each command entry such as temperature or dryness. Additionally, it will sound for 5-seconds at the end of a cycle.

Automatic Cycle Adjustment

The microprocessor controller (computer) automatically adjusts for a 50 cycle or 60 cycle operation.

Dryness Level

The dryness level is adjustable from 1 (less dry) to 9 (more dry) with a range tripler, which allows a total dryness level of 27 to be reached.

Reversing Dryers (Optional)

Reversing dryers have the option to select reversing or single direction drum rotation. The number of reverses per minute is selectable (1 or 2 reverses per minute). Reversing stop time is adjustable from 6 to 18-seconds in 4-second increments.

Non-Coin Computer Dip Switch Features

The dip switch (refer to the **illustration below**) is an 8-position red and white SPST switch mounted on the back of the computer. It has the following capabilities:

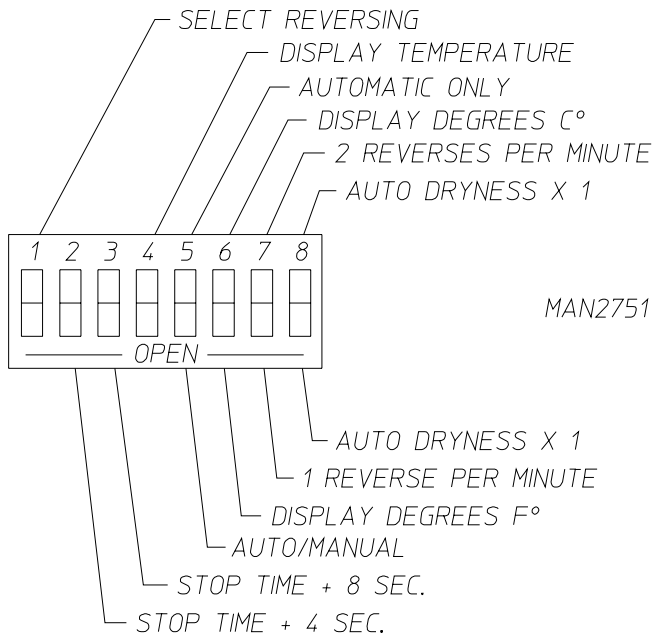

No.	Open	Closed
1		Select Reversing
2	Stop Time + 4-Seconds	
3	Stop Time + 8-Seconds	
4		Display Temperature
5	Auto/Manual	Auto Only
6	Display F	Display C
7	1 Reverse/Minute	2 Reverse/Minute
8	Dryness x 3	Dryness x 1

Switch #1 - On dryers equipped with the reversing basket (tumbler) option, by putting this switch into the closed position, the operator can select either reversing or non-reversing basket (tumbler) action when programming the computer at the start of each drying load. When this dip switch is put into the open position, the basket (tumbler) will always have reverse action. On non-reversing dryers, this switch **should be** opened. Display will show "Sr." Press "Enter/Start" for reversing action or press "0" for non-reversing.

Switch #2 and 3 - It is important on reversing dryers that the basket (tumbler) come to a complete stop before it changes its rotational direction. These two (2) switches control this stop time. When both switches are in the closed position, the stop time is 6-seconds. When switch #2 is opened and #3 is closed, the stop time is 10-seconds. When switch #2 is closed and switch #3 is opened, the stop time is 14-seconds. When both switches are opened, the stop time is 18-seconds. On non-reversing dryers, these switches **should be** closed.

Switch #4 - If switch #4 is closed, the computer will display the operating temperature of the dryer. This is only used for servicing the dryer. This switch **should be** closed only after the dryer is running. For normal dryer operation, this switch **must be** in the open position.

Switch #5 - By placing this switch into the closed position, the dryer will only operate in the automatic mode. On dryers equipped with the optional automatic/manual keyboard (touch pad), this switch **should be** put into the opened position.

Switch #6 - When the dryer is being serviced, the operating temperature of the dryer can be displayed (dip switch #4 is closed) in either Fahrenheit (switch #6 open) or Celsius (switch #6 closed).

Switch #7 - On dryers equipped with the optional reversing basket (tumbler), the number of reverses per minute can be set up by this dip switch. The basket (tumbler) will reverse once per minute if this switch is opened, or twice per minute if this switch is closed. On non-reversing dryers, the position of the switch is unimportant.

Switch #8 - When the computer is being programmed in the automatic mode, a dryness level of 1 through 9 **must be** selected. In some cases, a dryness level of more than 9 is required. If this switch is opened, the computer will triple the dryness level selected (for a maximum level of 27).

The dip switches have been factory set for the customer's requirements. These switches **should only be** changed if the dryer's operational requirements change.

Operating Instructions - Non-Coin Computer Dryer

The door **must be** closed for **ALL** data entries. During data entry, pressing "Clear/Stop" once will clear the present entry. Pressing it twice in succession resets the computer to its initial position. If the door is opened during a cycle, both basket (tumbler) and heat will stop. The cycle will continue only after the door is closed and "Enter/Start" is pressed. However, the computer will continue to count the time while the door is open.

A. COMPUTER DISPLAY CODES

FILL	Empty Dryer Prior to Data Entry (Auto/Manual Mode)
Fd	Display Prior to Data Entry When Auto Cycle is Selected, or Indicates Empty Dryer for Auto Only Dryer
Ld	Load Drying Time (Manual Mode)
LC	Load Cooling Time (Manual Mode)
F	Fabric Selection (Manual Mode)
Sr	Select Reversing (Reversing Dryers with Reverse/Non-Reverse Selectability)
Dr	Dryer is Operating in Drying Mode
CL	Dryer is Operating in Cool Down Mode
CC	Cycle Complete, Dryer has Finished a Complete Cycle and Shut Off
dSFL	Dryer Sensor Circuit Failure
door	Door Switch Failure, or Attempted Start has been made with Door Open

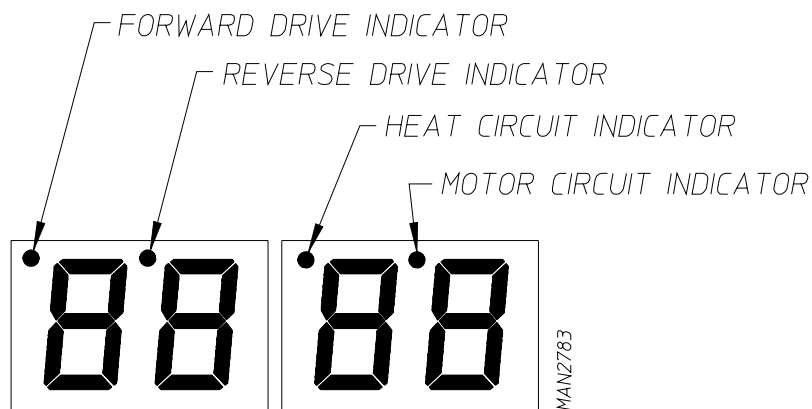

The non-coin computer dryer is available in an automatic only mode, or an automatic/manual selectable mode. It can also have the reversing basket (tumbler) option.

B. AUTOMATIC ONLY (NON-REVERSING DRYERS)

Dip switch settings - Switch #1 - open
Switch #2 - closed
Switch #3 - closed
Switch #4 - open
Switch #5 - closed
Switch #6 - unimportant
Switch #7 - unimportant
Switch #8 - closed (open for dryness level tripler)

1. Display shows “F_d_.”
2. Enter fabric selection; “1-9” selection appears after the letter “F_” in display.
3. Enter desired dryness level; “1 (less dry) through 9 (more dry)” selection appears after the letter “d_” in display.
4. Press “Enter/Start.”
5. Display reads “dr00” and will count upward until preset dryness level is reached.
6. At the end of the drying cycle, the dryer then starts the cooling cycle for 5 minutes, or until the temperature drops to approximately 100° F (38° C). During the cooling cycle, the display shows “CL” in the left two (2) digits, while the elapsed time from the initial start is displayed in the right two (2) digits.
7. At the end of the cooling cycle, an audible tone will sound, and the display will show “CC00” meaning the cycle is complete. Door **must now be** opened to cancel “CC00” display.

C. AUTOMATIC/MANUAL PROGRAM SELECTABLE (“AUTO” SELECTED, NON-REVERSING DRYERS)

Dip switch settings - Switch #1 - open
Switch #2 - closed
Switch #3 - closed
Switch #4 - open
Switch #5 - open
Switch #6 - unimportant
Switch #7 - unimportant
Switch #8 - closed (open for dryness level tripler)

1. Display shows “FILL.”
2. Enter auto selection, press AUTO 3 .
3. Display shows “F_d_.”
4. Refer to **Section B** “Auto Only” for instructions.

D. AUTOMATIC/MANUAL PROGRAM SELECTABLE (“MANUAL” SELECTED, NON-REVERSING DRYERS)

Dip switch settings - Switch #1 - open
Switch #2 - closed
Switch #3 - closed
Switch #4 - open
Switch #5 - open
Switch #6 - unimportant
Switch #7 - unimportant
Switch #8 - unimportant

1. Display shows “FILL.”
2. Enter manual selection, press .
3. Display shows “Ld_.”
4. Enter drying time (1 through 99 minutes).
5. Press “Enter/Start.”
6. Display shows “LC_.”
7. Enter cooling time (1 through 99 minutes).
8. Press “Enter/Start.”
9. Display shows “F_.”
10. Enter fabric (Temp) (1 through 9).
11. Press “Enter/Start.”
12. Display shows “dr and drying time entered,” display will then count down until selected time reaches zero.
13. Display shows “CL and cool down time entered,” display will then count down until selected time reaches zero.
14. At the end of the cooling cycle, an audible tone will sound, and the display will show “CC00” meaning cycle is complete. Door **must now be** opened to cancel display.

E. MICROPROCESSOR REVERSING DRYER

1. For dryers equipped with reversing option, dryer will always have reversing action if dip switch #1 is in the open position.
2. For dryers equipped with reversing option and programmed for reverse action selectability, (dip switch #1 is in the closed position).

- a. “Auto” selected - follow steps 1 through 4 under “Auto Only” instructions of **Section B**. After completing step 4, display will show “Sr_.”
 - 1) Press “Enter/Start” if reversing action is desired.
 - 2) Press “0” for non-reversing.

- b. “Manual” selected - follow steps 1 through 11 for “Manual Selected” operation of **Section D**. After completing step 11, display will show “Sr_.”
 - 1) Press “Enter/Start” if reversing action is desired.
 - 2) Press “0” for non-reversing.

Dip switches 2, 3, and 7 **must be** set for basket (tumbler) stop time and reverses per minute.

SECTION X

SERVICE/PARTS INFORMATION

A. SERVICE

1. Service **must be** performed by a qualified trained technician, service agency, or gas supplier. If service is required, contact the reseller from whom the **ADC** equipment was purchased. If the reseller **cannot** be contacted or is unknown, contact the **ADC** Service Department for a reseller in your area.

NOTE: When contacting the **ADC** Service Department, be sure to give them the correct **model number** and **serial number** so that your inquiry is handled in an expeditious manner.

B. PARTS

1. Replacement parts **should be** purchased from the reseller from whom the **ADC** equipment was purchased. If the reseller **cannot** be contacted or is unknown, contact the **ADC** Parts Department for a reseller in your area. Parts may also be purchased directly from the factory by calling the **ADC** Parts Department at (508) 678-9000 or you may FAX in your order at (508) 678-9447.

NOTE: When ordering replacement parts from the **ADC** reseller or the **ADC** factory be sure to give them the correct **model number** and **serial number** so that your parts order can be processed in an expeditious manner.

SECTION XI

REPLACEMENT PARTS LIST

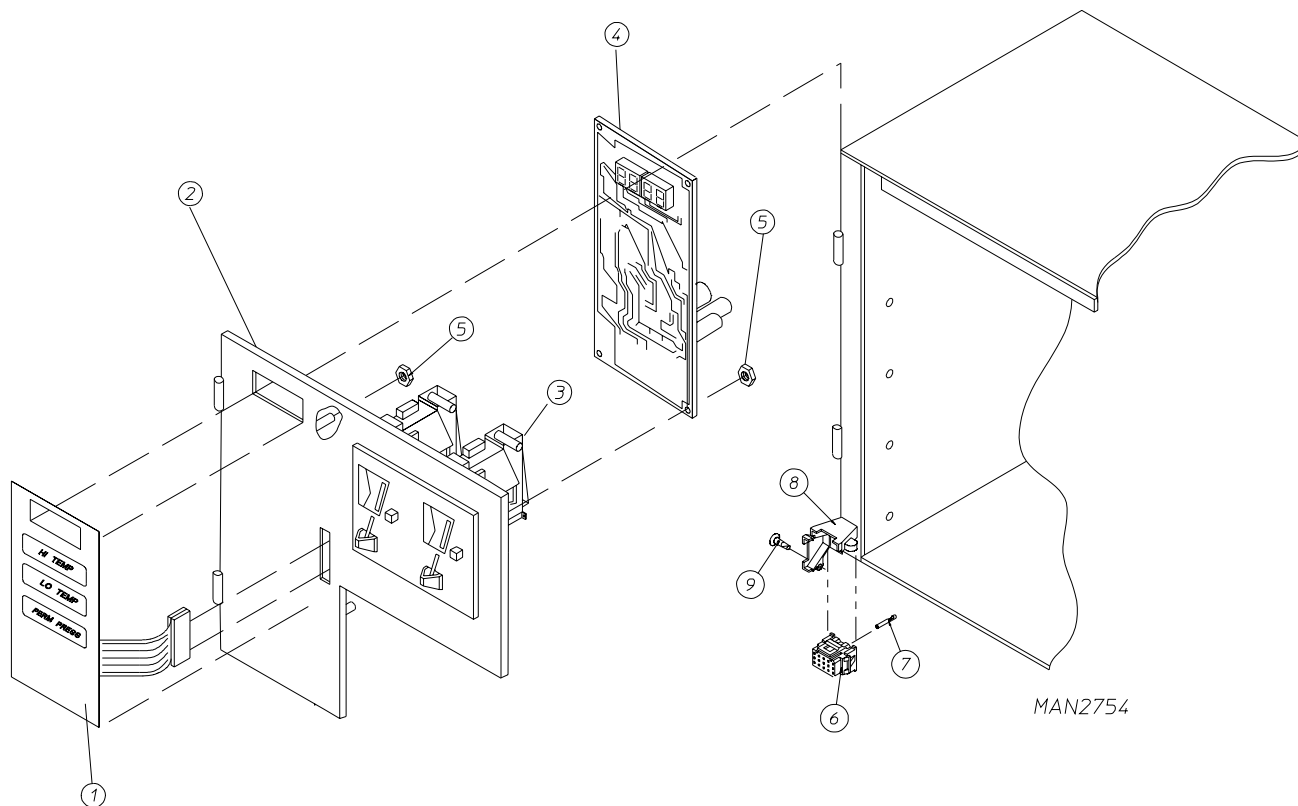

NOTE: The above illustration may not depict your particular dryer exactly. This illustration is a composite of the various dryer models. Be sure to check the descriptions of the parts thoroughly before ordering.

Replacement Parts For Phase 3

<u>Illus. No.</u>	<u>Part No.</u>	<u>Qty.</u>	<u>Description</u>
1	112526	1	Phase 3 Coin Keyboard (touch pad) Label
2	800040	1	Control Panel ONLY
	800087	1	Phase 3 Coin Control Panel Complete (Less Acceptor)
3*	865460	1	25¢ Single Coin Optic Acceptor
	865476	1	10¢/25¢ Dual Coin Optic Acceptor
4	137075	1	Phase 3 Coin Controller
5	152001	4	#8-32 Hex Nut
6	137020	1	15-Pin Connector ONLY
7	137021	15	Microprocessor Socket
8	137022	1	Strain Relief
9	150301	1	#8-18 x 7/16" Phillips TEK Screw

* Consult **ADC** factory for coin acceptors not listed.

Additional Parts Available But Not Illustrated

<u>Part No.</u>	<u>Qty.</u>	<u>Description</u>
136052	2	4-Amp Fuse
122800	1	Microprocessor Pin Extractor Tool
137056	1 or 2	Optical Switch ONLY
401020	1	Adhesive for Mounting Optical Switch
137023	1 or 2	Optical Switch Connector ONLY
865050	1	Single Coin Field Replacement Optical Switch Harness
865051	1	Dual Coin Field Replacement Optical Switch Harness

SECTION XII

WARRANTY INFORMATION

A. RETURNING WARRANTY CARDS

1. Before any dryer leaves the **ADC** factory test area, a warranty card is placed on the back side of the main door glass. These warranty cards are intended to serve the customer where we record the individual installation date and warranty information to better serve you should you file a warranty claim.
 - a. If a warranty card did not come with your dryer, contact the **ADC** Warranty Department or the **ADC** Service Department at (508) 678-9000.

IMPORTANT: A separate warranty card *must be* completed and returned for each individual dryer.

NOTE: Be sure to include the installation date when returning the warranty card(s).

B. WARRANTY

For a copy of the **ADC** commercial warranty covering your particular dryer(s), contact the **ADC** reseller from whom you purchased the equipment and request a dryer warranty form. If the reseller **cannot** be contacted or is unknown, warranty information can be obtained from the factory by contacting the **ADC** Warranty Department at (508) 678-9000.

NOTE: Whenever contacting the **ADC** factory for warranty information, be sure to have the dryer's **model number** and **serial number** available so that your inquiry can be handled in an expeditious manner.

C. RETURNING WARRANTY PARTS

ALL dryer or parts warranty claims or inquires **should be** addressed to the **ADC** Warranty Parts Department. To expedite processing, the following procedures **must be** followed:

1. No parts are to be returned to **ADC** without prior written authorization ("Return Material Authorization" [R.M.A.]) from the factory.

NOTE: An R.M.A. is valid for only thirty (30) days from date of issue.

- a. The R.M.A. issued by the factory, as well as any other correspondence pertaining to the returned part(s), **must be** included inside the package with the failed merchandise.

2. Each part **must be** tagged with the following information:
 - a. **Model number** and **serial number** of the dryer from which part was removed.
 - b. Nature of failure (be specific).
 - c. Date of dryer installation.
 - d. Date of part failure.
 - e. Specify whether the part(s) being returned is for a replacement, a credit, or a refund.

NOTE: If a part is marked for a credit or a refund, the invoice number covering the purchase of the replacement part **must be** provided.

NOTE: Warranty tags (ADC Part No. 450064) are available at “no charge” from ADC upon request.

3. The company returning the part(s) must clearly note the complete company name and address on the outside of the package.
4. **ALL** returns **must be** properly packaged to insure that they are not damaged in transit. *Damage claims are the responsibility of the shipper.*

IMPORTANT: No replacements, credits, or refunds **will be** issued for merchandise damaged in transit.

5. **ALL** returns **should be** shipped to the ADC factory in such a manner that they are insured and a proof of delivery can be obtained by the sender.
6. **Shipping charges are not the responsibility of ADC. ALL returns should be “prepaid” to the factory. Any “C.O.D.” or “COLLECT” returns will not be accepted.**

IMPORTANT: No replacements, credits, or refunds **will be** issued if the claim **cannot** be processed due to insufficient information. The party filing the claim **will be** notified in writing, either by “FAX” or “CERTIFIED MAIL - Return Receipt Requested,” as to the information necessary to process claim. If reply **is not** received by the ADC Warranty Department within thirty (30) days from the FAX/letter date, then no replacements, credits, or refunds **will be** issued, and the merchandise **will be** discarded.

SECTION XIII

ROUTINE MAINTENANCE

A. CLEANING

A program and/or schedule **should be** established for periodic inspection, cleaning, and removal of lint from various areas of the dryer, as well as throughout the ductwork system. The frequency of cleaning can best be determined from experience at each location. Maximum operating efficiency is dependent upon proper air circulation. The accumulation of lint can restrict this airflow. If the guidelines in this section are met, an ADC dryer will provide many years of efficient, trouble free, and most importantly, safe operation.

WARNING: LINT FROM MOST FABRICS IS HIGHLY COMBUSTIBLE. THE ACCUMULATION OF LINT CAN CREATE A POTENTIAL FIRE HAZARD.

WARNING: KEEP DRYER AREA CLEAR AND FREE FROM COMBUSTIBLE MATERIALS, GASOLINE, AND OTHER FLAMMABLE VAPORS AND LIQUIDS.

WARNING: TO AVOID THE HAZARD OF ELECTRICAL SHOCK, DISCONTINUE ELECTRICAL POWER TO THE DRYER.

NOTE: Suggested time intervals shown are for average usage, which is considered six (6) to eight (8) operational (running) hours per day.

IMPORTANT: Dryer produces combustible lint and *must be* exhausted to the outdoors. Every 6 months, inspect the exhaust ducting and remove any lint build up.

SUGGESTED CLEANING SCHEDULE

DAILY (BEGINNING OF EACH WORK SHIFT)

Clean lint from lint trap, screen, bottom, and walls of the lint chamber. Inspect lint screen and replace if torn.

90 DAYS

Remove lint accumulation from lint chamber, thermostats, sensor, and also from the motor air vents and surrounding area.

120 DAYS

Remove lint from gas burner area with a dusting brush or vacuum cleaner attachment.

NOTE: To prevent damage, avoid cleaning or touching ignitor (Globar®).

6 MONTHS

Inspect and remove lint accumulation in customer furnished exhaust ductwork system. Clean lint/dust accumulation from between fins of steam coil.

WARNING: THE ACCUMULATION OF LINT IN THE EXHAUST DUCTWORK CAN CREATE A POTENTIAL FIRE HAZARD.

NOTE: When cleaning dryer cabinet(s), avoid using harsh abrasives. A product intended for the cleaning of appliances is recommended.

B. ADJUSTMENTS

7 DAYS AFTER INSTALLATION AND EVERY 6 MONTHS THEREAFTER

Inspect bolts, nuts, screws, (bearing setscrews), grounding connections, and nonpermanent gas connections (unions, shutoff valves, and orifices). Inspect motor and drive belts. Cracked or seriously frayed belts **should be** replaced. Tighten loose belts when necessary and check alignment. Complete operational check of controls and valves. Complete operational check of **ALL** safety devices (door switch, lint drawer switch, sail switch, burner, and lint chamber thermostats).

C. LUBRICATION

The motor bearings, idler bearings, and basket (tumbler) bearings are permanently lubricated, and no lubrication is necessary. Some basket (tumbler) bearings are equipped with grease fittings. Should lubrication ever be found necessary, use a general purpose lithium-based grease. (**DO NOT** use animal or vegetable-based lubricants.) **DO NOT** overgrease. Be sure grease fitting is thoroughly cleaned of **ALL** foreign material before greasing.

SECTION XIV

TROUBLESHOOTING

IMPORTANT: YOU MUST DISCONNECT AND LOCKOUT THE ELECTRIC SUPPLY AND THE GAS SUPPLY OR THE STEAM SUPPLY BEFORE ANY COVERS OR GUARDS ARE REMOVED FROM THE MACHINE TO ALLOW ACCESS FOR CLEANING, ADJUSTING, INSTALLATION, OR TESTING OF ANY EQUIPMENT PER OSHA (Occupational Safety and Health Administration) STANDARDS.

The information provided is a quick reference to help isolate the most probable component(s) associated with the difficulty described. The experienced technician realizes, however, that a loose connection or broken or shorted wire may be at fault where electrical components are concerned...not necessarily the suspect component itself. Electrical parts **should always be** checked for failure before being returned to the factory. The information provided **should not be** misconstrued as a handbook for use by an untrained person in making repairs.

IMPORTANT: When replacing blown fuses, the replacement *must be* of the exact rating as the fuse being replaced.

WARNING: ALL SERVICE AND TROUBLESHOOTING SHOULD BE PERFORMED BY A QUALIFIED PROFESSIONAL.

WARNING: WHILE MAKING REPAIRS, OBSERVE ALL SAFETY PRECAUTIONS DISPLAYED ON THE DRYER AND/OR SPECIFIED IN THIS MANUAL.

A. The dryer will not start...

1. Open fuse box or circuit breaker switch or blown fuses.
2. Improper power supply voltage.

B. The basket (tumbler) motor runs, but the basket (tumbler) will not revolve. The heating unit is operating...

1. Broken, damaged, or loose V-belts.
2. Belts are contaminated (oil, grease, etc.).

C. The dryer starts, but the heating unit is not running...

1. The hi-limit thermostat is defective.
2. The lint door is open.
3. The sail switch is out of adjustment or is defective.
4. A defective control relay.
5. A defective relay contactor coil (416/480V ELECTRIC DRYERS).
6. The manual reset thermostat has tripped.
7. A defective gas or steam valve solenoid.

D. The dryer operates, but is taking too long to dry load...

1. An inadequate exhaust system.
2. Insufficient make-up air openings.
3. One of the relay contactor coils is defective (208/240V ELECTRIC DRYERS).
4. Clean lint drawer and check exhaust ducts for blockage.
5. Make-up air openings are closed.
6. Extractors are not performing properly.
7. An exceptionally cold/humid or low barometric pressure atmosphere.
8. The supply gas may have a low heating value. Check with gas supplier.

E. The dryer will not stop...

1. Defective motor contactor.

F. The basket (tumbler) is not reversing...

1. Defective microprocessor controller (computer).
2. Defective reversing contactor coil.

G. One of the motors keeps overheating...

1. Either an exceptionally low or high voltage supply.
2. Motor bearing failure.
3. Motor overload control is defective.

4. An idler bearing or basket (tumbler) drive bearing failure.
5. Motor air vents are blocked with lint.
6. Defective motor.

H. An excessive noise or vibration in the dryer...

1. The basket (tumbler) is out of adjustment.
2. The V-belts are too loose or too tight.
3. Loose basket (tumbler) rod.
4. Basket (tumbler) bearing or idler bearing failure.
5. Basket (tumbler) adjustment bolts are loose.
6. Loose motor mount.
7. Loose hardware.

I. The dryer is cycling on the hi-limit switch...

1. Blower motor failure.
2. An insufficient air supply.
3. Lint trap (basket) needs cleaning.
4. Insufficient exhaust system size or duct restriction.
5. Lint door open.

J. The impellor motor or the drive motor will not operate...

1. Motor relay coil is defective.
2. Motor is defective.

K. The dryer does not start, display shows “door”...

1. Door switch failed. Check for continuity with button depressed.
2. Check gray colored wires.
3. Check connectors.
4. Replace door switch.

L. Display shows “dSFL”...

1. Dryer sensor failed. Check if sensor is missing from holder.
2. Check wires leading to sensor from connector to connector.
3. Replace temperature sensor.

M. Dryer does not respond to command at keyboard (touch pad)...

1. Disconnect power.
2. Check flexible cable from keyboard (touch pad) to microprocessor controller (computer).
3. Dryer sensor missing from holder.

N. Dryer motor starts, but gas valve and Global[®] DO NOT operate...

1. Manual reset thermostat is open...reset.
2. Sail switch is open...readjust.
3. Hi-limit switch is open. Remove the connectors and then shut it. Make a test. Replace switch and reconnect wiring. Be sure to reconnect wires to switch if switch is not defective.
4. No voltage supply to gas valve...open connection. Trace circuit with volt or ohm meter. Repair connection or wire.

O. Dryer motor starts, gas valve’s primary coil operates, but Global[®] does not heat up...

1. Broken Global[®]...replace.
2. Faulty wire connection to either Global[®] or IR sensor.

P. Dryer motor starts, gas valve and Global[®] operate, but gas does not come on...

1. Defective flame switch...replace.
2. Defective gas valve...replace.
3. Very low voltage. Contact your local utility service.

Q. ALL components are operating, but gas is not ignited...

1. Improper position of Global[®]...adjust. Position Global[®] closer to the burner.
2. Low gas pressure...check manifold pressure.
3. Adverse air disturbance around front of burner could cause failure of ignition. Determine cause of draft and eliminate it.

SECTION XV

OPTIONAL 9 VOLT BATTERY BACKUP

Dryers ordered from the factory with the 9 volt battery option (battery is not included) allows the microprocessor controller (computer) to maintain its operating status should a momentary power interruption occur while the dryer cycle is in progress.

It is suggested that the battery be replaced at least once a year or as found necessary. The battery life will depend on the age of the battery, the amount of power interruptions, and backup time used.

IMPORTANT: For proper operation use alkaline batteries only. Suggest Eveready, Energizer, Duracell, or its equivalent. ***DO NOT USE CARBON TYPE BATTERIES.***



Free Manuals Download Website

<http://myh66.com>

<http://usermanuals.us>

<http://www.somanuals.com>

<http://www.4manuals.cc>

<http://www.manual-lib.com>

<http://www.404manual.com>

<http://www.luxmanual.com>

<http://aubethermostatmanual.com>

Golf course search by state

<http://golfingnear.com>

Email search by domain

<http://emailbydomain.com>

Auto manuals search

<http://auto.somanuals.com>

TV manuals search

<http://tv.somanuals.com>