

Owners Guide for the

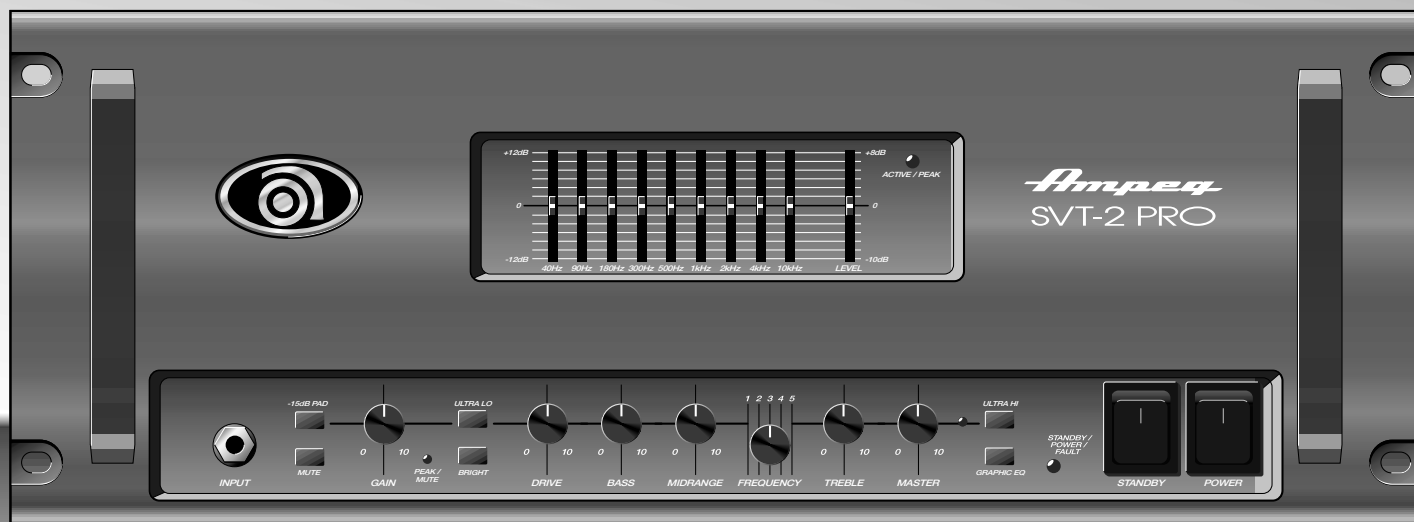

SVT-2 PRO

Bass Amplifier



Ampeg® is Proudly Made in America



TABLE OF CONTENTS

- Important Safeguards and Precautions2
- Introduction3
- Features3
- System Block Diagram3
- The Front Panel Controls and Their Use4
- The Rear Panel5
- Some Suggested Settings6
- Changing the Tubes7
- Setting Tube Bias7
- Troubleshootingback cover
- Technical Specificationsback cover

Important Safeguards and Precautions:

All Ampeg products are designed for continuous safe operation, as long as common sense is used and steps are taken to help avoid certain problems. Abiding by the following rules can help prevent damage to your preamp, yourself and others.

- The amplifier is equipped with a three-pronged AC power cord. To reduce the risk of electrical shock, **NEVER** remove or otherwise attempt to defeat the ground pin of the power cord.
- Connect the amplifier **ONLY** to a properly grounded AC outlet of the proper voltage for your amp.
- Avoid sudden temperature extremes, rain and moisture. Also, avoid sudden and intense impact. (If the unit has been subjected to any of the preceding abuses, have it looked at by an authorized service center.)
- **Never** set the amplifier on a support that might give out under its weight.
- When using tall or stacked speaker cabinets, use them **ONLY** on a level surface. **NEVER** set tall or stacked cabinets on a surface with more than a five degree incline since tipping or falling could occur, possibly causing serious injuries.
- Always keep the total speaker impedance at or above the rated load.
- Unplug the amplifier before cleaning it. **NEVER** spray liquid cleaners onto the amp. Wipe it with a slightly dampened, lint-free cloth to remove dirt and film.
- Don't use the amplifier if it has sustained damage to the chassis, controls, or power cord. Refer the unit to an authorized service center for inspection.
- Amplifiers capable of producing high volume levels are also capable of inflicting permanent hearing loss or damage, if the exposure to such levels is prolonged. Such damage is progressive and irreversible!

CAUTION

RISK OF ELECTRIC SHOCK
DO NOT OPEN

CAUTION: TO REDUCE THE RISK OF ELECTRIC SHOCK, DO NOT REMOVE COVER. NO USER-SERVICEABLE PARTS INSIDE. REFER SERVICING TO QUALIFIED SERVICE PERSONNEL.

ATTENTION

RISQUE D'ELECTROCUTION
NE PAS OUVRIR

ATTENTION: POUR REDUIRE D'ELECTROCUTION NE PAS ENLEVER LE COUVERCLE. AUCUNE PIECE INTERNE N'EST REPRABLE PAR L'UTILISATEUR. POUR TOUTE REPARATION, S'ADRESSER A UN TECHNICIEN QUALIFIE.

VORSICHT

ELEKTRISCHE SCHLAGGEFAHR
NICHT OFFENEN

VORSICHT: ZUR MINIMIERUNG ELEKTRISCHER SCHLAGGEFAHR NICHT DEN DECKEL ABENHMEN. INTERNE TEILE KONNEN NICHT VOM BENUTZER GEWARTET WERDEN. DIE WARTUNG IS QUALIFIZIERTEM WARTUNGSPERSONAL ZU UBERLASSEN.

THIS EQUIPMENT HAS BEEN DESIGNED AND ENGINEERED TO PROVIDE SAFE AND RELIABLE OPERATION. IN ORDER TO PROLONG THE LIFE OF THE UNIT AND PREVENT ACCIDENTAL DAMAGES OR INJURY, PLEASE FOLLOW THESE PRECAUTIONARY GUIDELINES:

WARNING: TO REDUCE THE RISK OF ELECTRIC SHOCK, DO NOT OPEN CHASSIS; DO NOT DEFEAT OR REMOVE THE GROUND PIN OF THE POWER CORD; CONNECT ONLY TO A PROPERLY GROUNDED AC POWER OUTLET.

CAUTION: TO REDUCE THE RISK OF FIRE OR ELECTRIC SHOCK, DO NOT EXPOSE THIS EQUIPMENT TO RAIN OR MOISTURE.

CAUTION: NO USER-SERVICEABLE PARTS INSIDE. REFER SERVICING TO QUALIFIED SERVICE PERSONNEL.

CAUTION: OUR AMPLIFIERS ARE CAPABLE OF PRODUCING HIGH SOUND PRESSURE LEVELS. CONTINUED EXPOSURE TO HIGH SOUND PRESSURE LEVELS CAN CAUSE PERMANENT HEARING IMPAIRMENT OR LOSS. USER CAUTION IS ADVISED AND EAR PROTECTION IS RECOMMENDED IF UNIT IS OPERATED AT HIGH VOLUME. The chart below shows the U.S. Government Occupational Safety and Health Administration (OSHA) regulations which were in effect at the time of this publication for permissible noise exposure, per 29CRF1910, Table G-16.

SOUND LEVEL dBA SLOW RESPONSE	DURATION PER DAY IN HOURS	SOUND LEVEL dBA SLOW RESPONSE	DURATION PER DAY IN HOURS
90	8	102	1-1/2
92	6	105	1
95	4	110	1/2
97	3	115	1/4 or less
100	2		

According to OSHA, any exposure in excess of those listed above could result in some hearing loss.

EXPLANATION OF GRAPHICAL SYMBOLS:



"DANGEROUS VOLTAGE"
"DANGER HAUTE TENSION"
"GEFAHRLICHE SPANNUNG"



"IT IS NECESSARY FOR THE USER TO REFER TO THE INSTRUCTION MANUAL"
"REFERREZ-VOUS AU MANUAL D'UTILISATION"
"UNBEDINGT IN DER BEDIENUNGSANLEITUNG NACHSCHLAGEN"



An Introduction to your new Ampeg SVT-2 PRO Bass Amplifier

The harmonically rich sound and legendary performance of the AMPEG SVT are redefined in the SVT-2 PRO. This dynamically powerful bass amplifier delivers a thundering 300 watts of unsurpassed quality, reliability and tonal flexibility, offering the classic vibrancy of tubes as well as contemporary features.

All of the features and controls of your SVT-2 PRO are covered in detail within the pages of this owner's guide. We recommend going over them before you use the amplifier.

Features

In the world of high performance bass amps, Ampeg's SVT amplifiers stand alone. Keeping with true Ampeg tradition, the SVT-2 PRO Bass Amplifier offers you more performance and flexibility than any other amplifier in its class. Listed below are some of the outstanding features of your new preamp - features which set it apart from the competition! Additional information on these features can be found on the pages indicated.

- **ATTENUATOR:** A switchable input pad, this feature is perfect for basses with active electronics or very "hot" pickups (page 4).
- **MUTE SWITCH:** Lets you cut the sound from the amp, letting you tune your bass in private (page 4).
- **ULTRA LOW, ULTRA HIGH AND BRIGHT SWITCHES:** Lets you tailor your sound in many different ways "with the touch of a button" (page 4).
- **5-POSITION MIDRANGE SELECTOR:** Take your pick from the five center frequency points available to get just the right midrange voice (page 4).
- **9-BAND GRAPHIC EQ:** Use as a "second channel" for bass solos, or to shape your sound to your own exacting standards. An independent level control lets you adjust the Graphic EQ volume. Switchable at front panel or with a footswitch (page 4).
- **BIAS ADJUSTMENT CONTROLS:** Let you adjust the tube bias for proper operation (pages 5,7).
- **SLAVE OUT:** Use for powering another amp from the SVT-2 PRO's preamp (page 5).

System Block Diagram

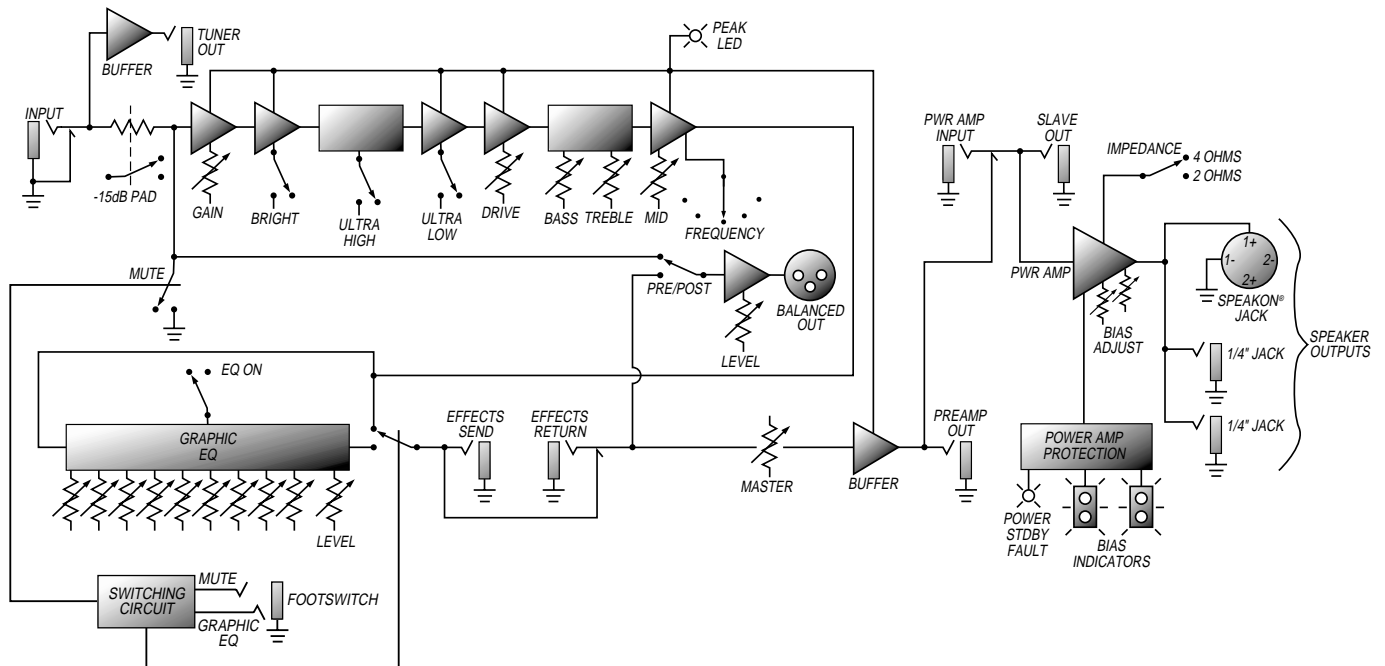



The Front Panel Controls and Their Use

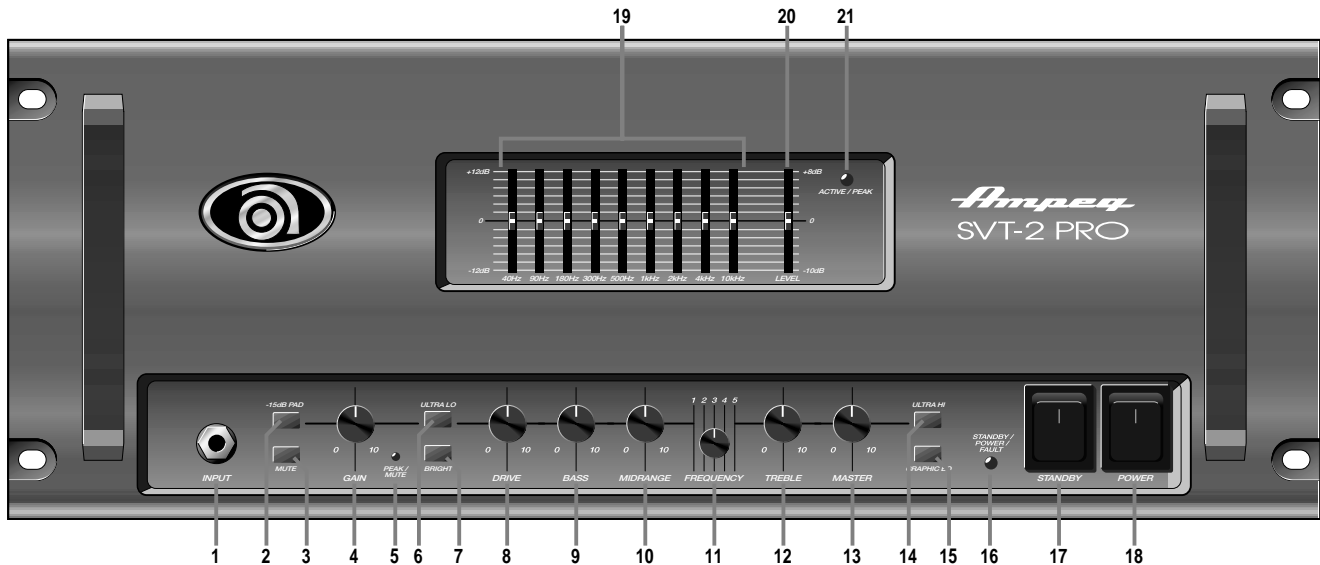

1. INPUT: This jack accepts a passive or active instrument or a line level signal through a shielded instrument cable.

2. PAD: This switch attenuates the input signal by 15dB. Attenuation allows the Gain control (4) to be used in a more usable (higher) position. If clipping is indicated even with the Gain control all the way down, attenuation is needed.

3. MUTE: This switch kills the input to everything except the Tuner Out (34) to allow silent tuning.

4. GAIN: This control, along with the Attenuator switch (2), adjusts the basic level of signal in the preamp. To get the best signal to noise ratio, set this control so that, on the loudest passages, the Peak LED (5) flashes occasionally.

5. PEAK/MUTE LED: This LED flashes when the signal level in the preamp (excluding the Graphic EQ) approaches clipping. When the Mute switch (3) is engaged, this LED stays on as a visual indicator that Mute is active.

6. ULTRA LOW: This switch, when engaged, provides emphasis to the low frequencies by boosting the low frequencies and selectively cutting the mid frequencies.

7. BRIGHT: This switch, when pushed IN, boosts upper mid and high frequencies.

8. DRIVE: This control is used to overdrive the preamp in order to get various distortion sounds. In the fully counterclockwise position the preamp is in the cleanest, traditional SVT condition. As the control is rotated clockwise, signal level is increased to drive the preamp harder (into distortion). The tone of the signal is also changed to provide a smoother overdrive. The tone controls may have to be readjusted to obtain the overall desired tone. The Gain control (4) and Attenuator switch (2) interact with the Drive control. For greater overdrive, the Attenuator switch should

be out and the Drive control fully clockwise. Use the Gain control to set the amount of overdrive desired. The Peak LED (5) will glow a steady red when the amp is used in this manner.

9. BASS: This is the primary low frequency control. It allows for 12dB of cut or boost at 40Hz.

10. MIDRANGE: This is the primary midrange control. It allows for 15dB of cut or 12dB boost at the center frequency selected by the Frequency control (11).

11. FREQUENCY: Allows you to select the center frequency for the Midrange control (10), giving you a choice of five "voices" for the Midrange. The center frequencies are (from left to right) 220Hz, 450Hz, 800Hz, 1.6kHz and 3kHz.

12. TREBLE: This is the primary high frequency control. It allows for 12dB of cut or boost at 4kHz.

13. MASTER: This controls the signal to the power amp and therefore the overall listening level. It also controls the level to the Preamp Out jack (27).

14. ULTRA HIGH: This switch boosts higher frequencies than those affected by the Bright switch (7).

15. GRAPHIC EQ: This switch places the Graphic EQ circuitry in or out of the signal path. The switch must be pushed IN for the Graphic EQ footswitch to function. In the OUT position, there is no solid state circuitry in the signal path from input to power amp out.

16. STANDBY/POWER/FAULT INDICATOR LED: This is a multi functional LED. In Standby mode, it glows red. In the On mode (when the high voltage comes on) it glows green. If it does not turn green in the On mode, there is no high voltage present and the unit needs servicing. If the amp detects a fault in the power tube circuit, the high voltage is turned off and the LED flash-

es between red and green. This usually indicates a bad power tube. The amp will remain in this condition until the unit is turned off.

17. STANDBY: The Standby mode allows the tubes to warm or remain warm without high voltage being applied to them. This extends tube life. During short periods of non-use, the amp should be put into Standby mode. When the amp is first turned on, it is automatically in Standby mode, regardless of the switch position. After approximately 20 seconds, the amp is in the mode selected by the switch.

18. POWER: This supplies AC power to the unit. This switch must be turned off to reset the amp after a Fault condition.

GRAPHIC EQ SECTION

The Graphic EQ can be used in two ways: 1) To fine tune your sound, make small adjustments at the desired frequencies and leave the EQ on throughout the entire session. (This is great for adapting to varying room acoustics when going from club to club, etc.) 2) For a completely different sound, make larger adjustments and only activate the EQ when you want a "second channel" sound (such as during bass solos).

19. FREQUENCY SLIDERS: These control the nine frequencies of the Graphic EQ section at the points indicated over each slider.

20. LEVEL: This adjusts the level of the signal to compensate for boosts or cuts, or for a desired level change when using the Graphic EQ.

21. ACTIVE LED: This LED glows green when the EQ section is enabled by the proper combination of Graphic EQ switch (15) and footswitch (35). It flashes red when the signal gets close to clipping.



The Rear Panel

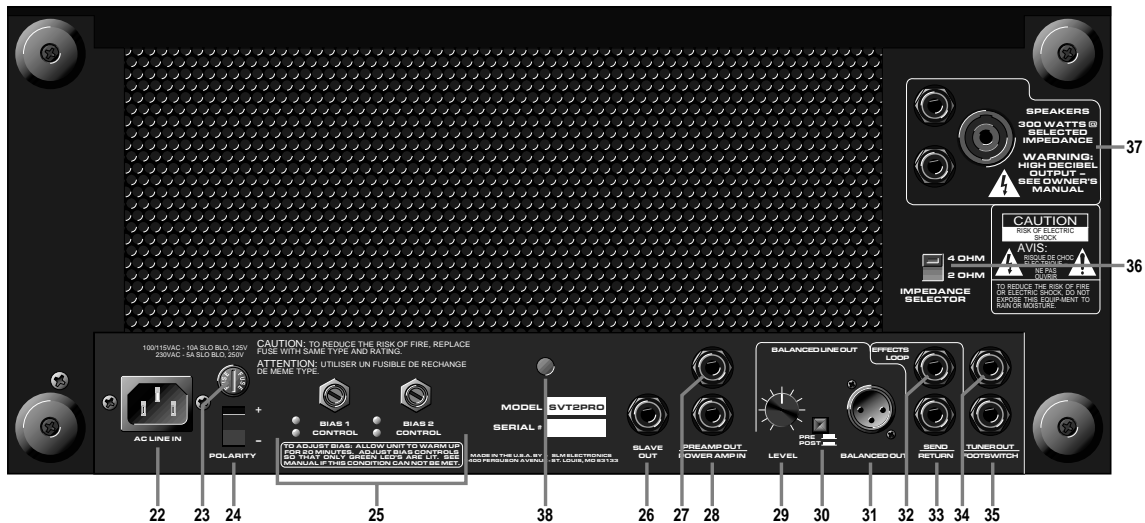

22. AC LINE IN: Firmly plug the supplied AC power cord into this socket, pushing it in until it is fully seated. Plug the male end of the cord into a grounded AC outlet. **DO NOT DEFEAT THE GROUND PRONG OF THE AC PLUG!**

23. FUSE: The fuse protects the amplifier from damage due to line current faults and other conditions. If the fuse blows, replace it only with the same size and type as listed on the amplifier.

24. POLARITY: Place this switch in the position that provides the least electrical buzz from the unit.

25. BIAS SECTION: These controls and LEDs allow the user to properly bias the power amp.

26. SLAVE OUT: This jack receives the same signal that is being sent to the power amp. It is useful for powering another amp (slave) from this unit's preamp.

27. PREAMP OUT: This jack carries the post-Master (13) signal. It does not break the path to the power amp. This signal can be used to feed an external power amplifier, mixing console, or house PA system.

28. POWER AMP IN: This jack accepts a signal to be sent to the power amp and the Slave Out jack (26). It does break the path from the Preamp Out jack (27). This can be used as a post-Master (13) patch point.

29. LEVEL: This control adjusts the level of the signal at the Balanced Out jack (31).

30. PRE/POST: This switch selects a direct out from the bass (Pre) in the OUT position and the

preamp signal just before the Master (Post) in the IN position to be sent to the Balanced Out jack (31).

31. BALANCED OUT: This XLR-type jack is the output as selected by the Pre/Post switch and adjusted by the Level control (29). This signal can be used to feed an external power amplifier, mixing console, or house PA system.

32. EFFECTS LOOP SEND: This is a post-EQ, pre-Master (13) patch point send jack. It does not break the path through the preamp. When using an external signal processor, connect the INPUT of the effect to this jack using a shielded instrument cable to send the signal to the effect for processing.

33. EFFECTS LOOP RETURN: This is a pre-Master (13) patch point return jack. It breaks the path through the preamp. When using an external signal processor, connect the OUTPUT of the effect to this jack using a shielded instrument cable to feed the processed signal into the power amp section.

34. TUNER OUT: This is a direct output from the instrument which can be routed to a tuner. It is the only output that stays active when the Mute switch (3) is engaged.

35. FOOTSWITCH: This is a stereo jack which will operate with a standard dual footswitch. The tip of the plug controls the Mute operation, the ring controls the Graphic EQ operation, while the sleeve acts as a ground common to both. With the footswitch inserted, both the front panel and the footswitch Mute switches are active. The

front panel Graphic EQ switch (15) must be IN for the Graphic EQ footswitch to operate.

36. IMPEDANCE SELECTOR: Use this switch to match the output impedance of the amp to the speaker(s) being used (2 or 4 ohms). For help in deciding the impedance of your system, consult the chart below.

Cabinet Impedance	# of Cabs	Total Impedance
4Ω	2	2Ω
8Ω	2	4Ω
8Ω	4	2Ω

37. SPEAKERS: These jacks are provided for connecting speakers to the unit. While the 1/4" jacks are convenient, the Speakon® connector is preferred for carrying the heavy current from this amplifier.

NOTE: In some areas the 1/4" speaker jacks are not acceptable for use on amplifiers capable of high output power levels. For this reason your amplifier may have been shipped with the 1/4" jacks sealed – use only the Speakon® jack for connecting your speakers.

38. This is a 1/4-20 weld-nut which can be used to provide additional support for the rear of the unit.



Some Suggested Settings*

ROCK:

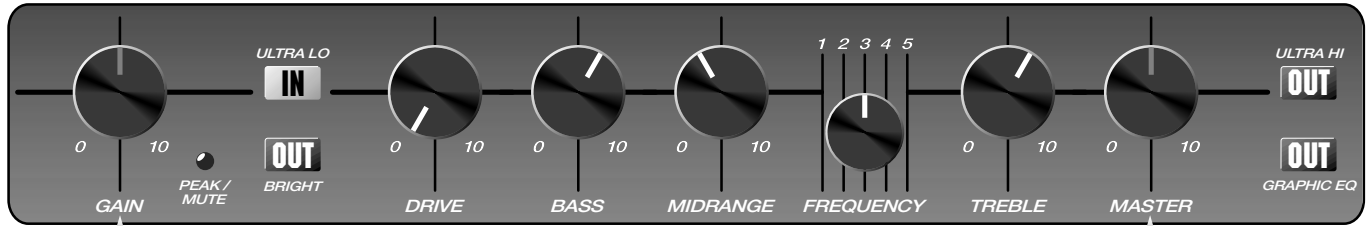

AS NEEDED

AS NEEDED

JAZZ:

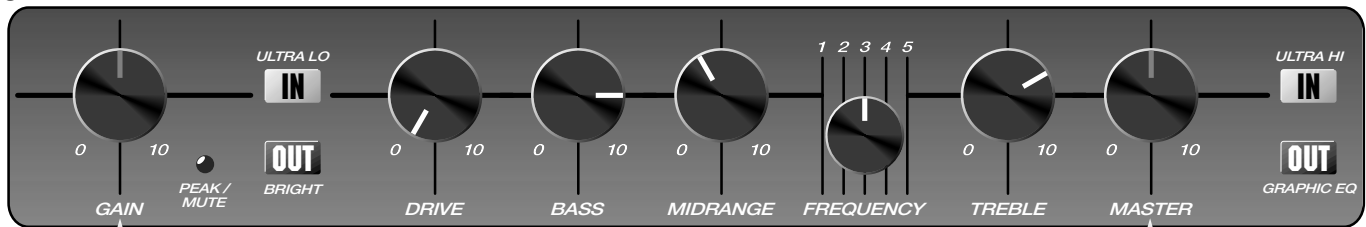

AS NEEDED

AS NEEDED

COUNTRY:

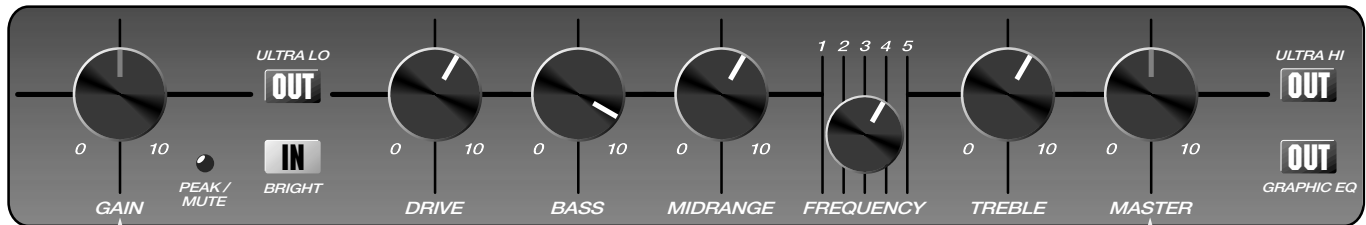

AS NEEDED

AS NEEDED

FUNK "POPPING":

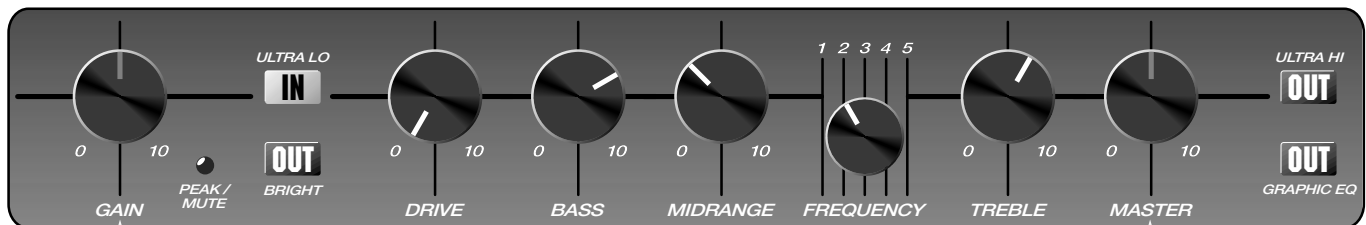

AS NEEDED

AS NEEDED

*A Note About The Graphic EQ:

The Graphic EQ can be used in two ways:

- 1) To fine tune your sound, make small adjustments at the desired frequencies and leave the EQ on throughout the entire session. (This is great for adapting to varying room acoustics when going from club to club, etc.);
- 2) For a completely different sound, make larger adjustments and only activate the EQ when you want a "second channel" sound (such as during bass solos).



Changing the Tubes

Tubes wear out in direct proportion to how often and how hard you play the amplifier. Power tubes should be checked at least once a year – more frequently if you use the amplifier nearly every day. When the power tubes wear out, the amplifier will begin to grow weak, lack punch, fade up and down, or lose highs and lows. Power tubes work together in a push/pull configuration and should all be replaced at the same time with matched or balanced tubes. Your dealer can recommend the best replacement tubes for your amplifier.

Preamp tubes aren't worked as hard as power tubes and typically last longer. When a preamp tube wears out, the amplifier may squeal, get noisy, lose gain and sensitivity, or just quit working. A service center can determine which tube(s) may need replacing.

To get to the tubes in the SVT-II PRO, the rear screen must be removed and the tube retainer(s) must be moved out of the way. **Qualified service persons** may follow these steps to change the tubes:

- Turn the amp off, unplug it and let it cool for at least 5 minutes.
- Remove the screws which hold the four large plastic feet to the rear of the chassis. Set the feet and their screws aside.
- Taking care not to stretch or disconnect any wiring, gently set the perforated metal screen aside.
- Remove the tube retainer(s) by lifting them off the tube and moving them to one side.
- Grasp the tube at its top and gently work it out of its socket by rocking it slightly back and forth as you lift up on it.
- When inserting new output tubes, align the tab in the tube's plastic base with the slot in the socket and press the tube gently but firmly into place by pushing down on its top. Preamp tubes have a "missing pin" which corresponds with the "missing hole" in the socket – line up the missing pin and hole before pressing the tube into its socket.
- Replace the tube retainer(s) on the tube(s).
- Replace the perforated screen, the four large plastic feet, and tighten their screws.
- Power up the amplifier and let it sit for at least 20 minutes. Bias the amplifier as directed in the section below.

Setting Tube Bias

Allow the unit to warm up at proper AC line voltage for at least 20 minutes. With no input signal present, adjust each control so that only the associated green LED is lit. The controls may be slightly interactive. If neither LED is lit, the amp is overbiased. This will result in some distortion in the power amp and a generally thin sound. If the green and red LED are lit, the amp is underbiased and too much current is flowing in the power tubes. This will give a big, full sound but will also reduce the life of the power tubes. Once set, the controls should not have to be changed except as needed for tube replacement, or to compensate for tube aging. Note that the AC line voltage may vary from place to place and the LEDs will read slightly different. There is no need to fiddle with this every other day. Note that it is normal for the red LEDs to light when there is a signal present. Bias 1 Control adjusts the three left (as seen from the rear) power tubes. Bias 2 Control adjusts the three right power tubes. By observing the LEDs as the Bias Controls are slowly rotated clockwise, a number of tube problems can be diagnosed by the user:

<u>Condition</u>	<u>Problem</u>	<u>Solution</u>
Green comes on, then red	No problem	(The longer the green LED is on before the red LED comes on, the better matched the tubes are.)
Red comes on, then green	Tubes not properly matched	Set slightly before green comes on, obtain matched tubes when possible.
Red comes on, no green	One or more tubes are non-functioning	Check to make sure tubes are all seated properly; if so, find and replace bad tube(s).
None on	Possibly no high voltage or bad Bias Control or bad tube(s)	Have unit checked by a service technician.
Both on all the time	Possible bad Bias Control or bad tubes	Have unit checked by a service technician.

If the tubes are bad enough to cause damage to the unit, the Fault Indicator (#16, front panel) will signal and the unit will shut down.



SVT-2 PRO Bass Amplifier

Technical Specifications

OUTPUT POWER RATING	300 Watts RMS minimum continuous @ <3% THD into 2 or 4 ohms, 0.4VRMS input
TOTAL SYSTEM GAIN	76dB, @1kHz w/levels up, tones flat; -3dB @30Hz, 15kHz
TONE CONTROL RANGE	<p>Bass: ±12dB @ 40Hz</p> <p>Midrange: +12dB, -15dB @ Frequency selected (220, 450, 800, 1.6k or 3kHz)</p> <p>Treble: ±12dB @ 4kHz</p> <p>Ultra Low: +3dB @ 40Hz, -12dB @ 500Hz</p> <p>Ultra High: +8dB @ 8kHz</p> <p>Bright: +7dB @ 2kHz</p>
GRAPHIC EQ RANGE	±12dB @ 40Hz, 90Hz, 180Hz, 300Hz, 500Hz, 1kHz, 2kHz, 4kHz, 10kHz
GRAPHIC EQ LEVEL	+8dB, -10dB
SIGNAL TO NOISE RATIO	80dB typical
TUBE COMPLEMENT	12AX7 (5), 12AU7 (3), 6550 (6)
POWER REQUIREMENTS	<p>Domestic: 120VAC, 60Hz, 460VA</p> <p>Export: 100/115VAC 50/60Hz, 460VA</p> <p>230VAC, 50/60Hz, 460VA</p>
SIZE AND WEIGHT	19"W x 3.75"H x 15.75"D; 70 lbs

Ampeg reserves the right to change specifications without notice.

Troubleshooting

In the unlikely event that your SVT-2 PRO should stop working properly (or just stop working), take a few minutes to troubleshoot it before you call for service. You can save yourself a lot of time and sometimes money by doing it yourself, and often the cure for the problem is something quite simple. If you think the problem may be worn out tubes, see page 7 for symptoms of tube failure.

If the problem isn't covered here, or if the steps led you to "Service Amp", then contact your Ampeg dealer for service information. Also, you should refer your amp for servicing if it gets dropped, has liquid spilled into it, or sustains damage to its power cord.

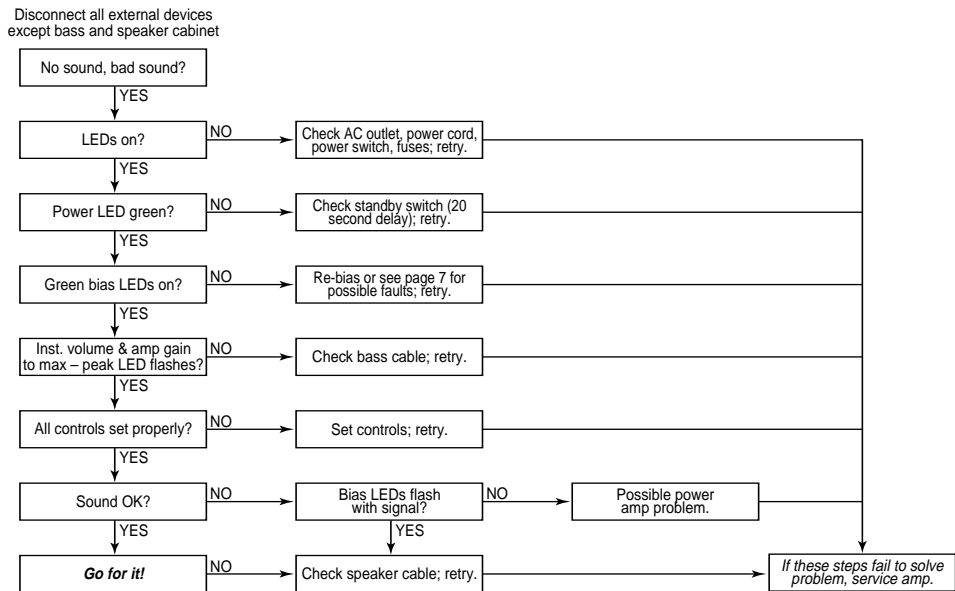

www.ampeg.com

Ampeg is proudly Made in America

©1998 SLM Electronics • 1400 Ferguson Avenue • St. Louis, MO 63133 U.S.A.

P/N 47-509-11 • 04/98

Download from Www.Somanuals.com. All Manuals Search And Download.



Free Manuals Download Website

<http://myh66.com>

<http://usermanuals.us>

<http://www.somanuals.com>

<http://www.4manuals.cc>

<http://www.manual-lib.com>

<http://www.404manual.com>

<http://www.luxmanual.com>

<http://aubethermostatmanual.com>

Golf course search by state

<http://golfingnear.com>

Email search by domain

<http://emailbydomain.com>

Auto manuals search

<http://auto.somanuals.com>

TV manuals search

<http://tv.somanuals.com>