

User's Guide for the



SVT-8 PRO

Bass Amplifier





TABLE OF CONTENTS

Introduction3
 Features3
 The Front Panel4
 The Rear Panel5
 Some Suggested Settings6
 Rack Mounting6
 Troubleshooting7
 System Block Diagram7
 Technical Specificationsback cover

IMPORTANT SAFETY INSTRUCTIONS

1. Read these instructions.
2. Keep these instructions.
3. Heed all warnings.
4. Follow all instructions.
5. Do not use this apparatus near water.
6. Clean only with a dry cloth.
7. Do not block any ventilation openings. Install in accordance with the manufacturer's instructions.
8. Do not install near any heat sources such as radiators, heat registers, stoves, or other apparatus (including amplifiers) that produce heat.
9. Do not defeat the safety purpose of the polarized or grounding-type plug. A polarized plug has two blades with one wider than the other. A grounding-type plug has two blades and a third grounding prong. The wide blade or the third prong are provided for your safety. If the provided plug does not fit into your outlet, consult an electrician for replacement of the obsolete outlet.
10. Protect the power cord from being walked on or pinched particularly at plugs, convenience receptacles, and the point where they exit from the apparatus.
11. Only use attachments/accessories specified by the manufacturer.
12. Use only with a cart, stand, tripod, bracket, or table specified by the manufacturer, or sold with the apparatus. When a cart is used, use caution when moving the cart/apparatus combination to avoid injury from tip-over.
13. Unplug this apparatus during lightning storms or when unused for long periods of time.
14. Refer all servicing to qualified service personnel. Servicing is required when the apparatus has been damaged in any way, such as power-supply cord or plug is damaged, liquid has been spilled or objects have fallen into the apparatus, the apparatus has been exposed to rain or moisture, does not operate normally, or has been dropped.
15. Please keep the unit in a good ventilation environment.
16. **WARNING:** To reduce the risk of fire or electric shock, do not expose this apparatus to rain or moisture. The apparatus shall not be exposed to dripping or splashing and that objects filled with liquids, such as vases, shall not be placed on apparatus.



17. **WARNING:** For the terminals marked with a symbol of "⚡" may be of sufficient magnitude to constitute a risk of electric shock. The external wiring connected to the terminals requires installation by an instructed person or the used of ready-made leads or cords.
18. **WARNING:** The appliance coupler is used as disconnect device, the disconnect device shall remain readily operable.
19. This apparatus is for professional and commercial use only.



20. This lightning flash with arrowhead symbol within an equilateral triangle is intended to alert the user to the presence of non-insulated "dangerous voltage" within the product's enclosure that may be of sufficient magnitude to constitute a risk of electric shock.
- WARNING:** To reduce the risk of electric shock, do not remove cover (or back) as there are no user-serviceable parts inside. Refer servicing to qualified personnel.
- The exclamation point within an equilateral triangle is intended to alert the user to the presence of important operating and maintenance instructions in the literature accompanying the appliance.
21. The apparatus should be connected to a mains socket outlet with a protective earthing connection.
22. **Correct Disposal of this product:** This marking indicates that this product should not be disposed with other household wastes throughout the EU. To prevent possible harm to the environment or human health from uncontrolled waste disposal, recycle it.
23. No naked flame sources, such as lighted candles, should be placed on the apparatus.
24. Attention should be drawn to environmental aspects of battery disposal.
25. **WARNING:** To reduce the risk of damage, do not set the amplifier on the feet of the rear panel. It is unstable and could easily tip over. Use the feet on the bottom of the amplifier instead.



An Introduction to your new Ampeg SVT-8 PRO Bass Amplifier

The harmonically rich sound and legendary performance of the AMPEG SVT are redefined in the SVT-8 PRO. This versatile and powerful bass amplifier delivers up to 2500 watts of unsurpassed musical power, and offers the classic vibrancy of tubes with several outstanding features.

All of the features and controls of your SVT-8 PRO are covered in detail within the pages of this user's guide. We recommend that you go over them before you use the amplifier.

Features

In the world of high performance bass amps, Ampeg's SVT amplifiers stand alone. In true Ampeg tradition, the SVT-8 PRO offers you more power, performance and flexibility than any other bass amplifier in its class. Below are some of the outstanding features of your new amplifier - features which set it apart from the competition!

- **-12DB SWITCH:** A switchable input pad which optimizes the input signal level for use with basses with active electronics or very "hot" pickups
- **MUTE SWITCH, TUNER OUT JACK:** Allows you to tune your bass without hearing it through the amplifier
- **5-POSITION ULTRA LOW SWITCH:** Five different settings for the Ultra Low provide the ultimate in bottom end response
- **ULTRA HIGH AND BRIGHT SWITCHES:** Allows you to tailor your high frequency response in many different ways at the touch of a button
- **5-POSITION MIDRANGE SELECTOR:** Choose from the five center frequency points available to get just the right midrange voice
- **POWER REDUCTION CIRCUIT:** A simulated tube power amp section allows you to get the desired amount of "tube power amp growl" at any volume
- **TRANSFORMER BALANCED LINE OUTPUT:** Allows you to send a high quality line level signal to the house mixing board, a recording console, or another amplifier - switchable for pre or post EQ with a switchable ground lift
- **EFFECTS LOOP:** Allows for virtually noise-free connection for use with your favorite effects
- **FOOTSWITCH CONTROL:** Allows hands-free remote control over the Mute and Power Reduction features
- **CIRCUIT BREAKER PROTECTION:** A heavy duty resettable circuit breaker provides protection against fault conditions
- **SPEAKON® SPEAKER OUTPUT JACKS:** For the ultimate connection and transmission of power to your speakers
- **ULTIMATE POWER:** 1300 watts into 4 ohms, 2500 watts into 2 ohms



The Front Panel

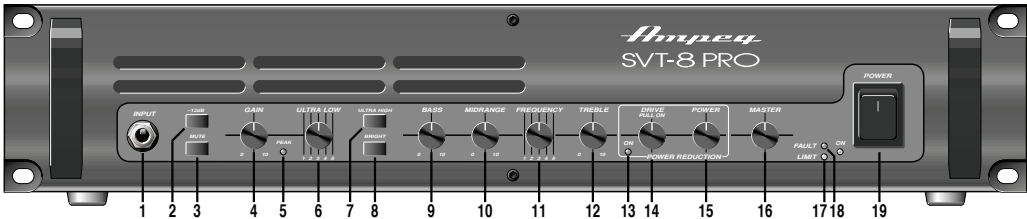

1. INPUT: Connect your bass guitar here by means of a shielded signal cable.

2. -12dB: This switch, when depressed, attenuates the input signal by 12dB. Attenuation allows the Gain control (#4) to be used over a larger portion of its range. If clipping is indicated with the Gain way down, attenuation is needed.

3. MUTE: This switch, when depressed, mutes all outputs except the Tuner Out (#24, rear panel). This allows you to use an electronic tuner without having to adjust any levels or turn down your house sound. A footswitch may be used to control the mute function as long as this switch is in the out position.

4. GAIN: This controls the gain of the preamp. Adjust this control until the Peak LED (#5) flickers on strong signal peaks (but is not illuminated constantly while playing).

5. PEAK: This LED illuminates when the signal level into the preamp or power amp nears clipping. Adjust the Gain control (#4) until a strong signal from your instrument causes this LED to flicker with the Master control (#16) set low.

NOTE: If the LED flickers frequently with the Gain at a low setting, use the -12dB switch (#2) to attenuate the input signal and readjust the Gain.

6. ULTRA LOW: Use this five-position rotary switch to optimize the low end response as follows:

- 1: Off – flat low frequency response
- 2: Sub Cut – reduces frequencies below the bass range to protect your speakers
- 3: Low Cut Classic – provides a low cut equal to our original SVT Classic amplifier

4. Ultra Low Classic – contours the sound to emphasize the low end just like our original SVT amplifier

5. Ultra Low Modern – provides a substantial low end boost

7. ULTRA HIGH: This switch, when depressed, adds about a 16dB boost to the high frequencies around 8kHz, depending on the setting of the Gain control.

8. BRIGHT: This switch, when depressed, adds a 6dB boost to the high frequencies at 3kHz.

9. BASS: Use this control to adjust the low frequency output level. This control provides +17-13 dB at 20Hz.

10. MIDRANGE: Use this control to adjust the midrange frequency output. This control provides +/-20dB at the frequency selected by the adjacent Frequency control (#11).

11. FREQUENCY: Use this control to select the center frequency for the Midrange control (#10) as follows:

- 1: 220Hz
- 2: 450Hz
- 3: 800Hz
- 4: 1.6kHz
- 5: 3kHz

12. TREBLE: Use this control to adjust the high frequency output level. This control provides +18/-20dB at 7kHz.

13. POWER REDUCTION ON: This LED illuminates when the Power Reduction function is active.

14. POWER REDUCTION DRIVE / PULL ON: This control, when engaged, determines the signal level sent to the simulated tube power amp section. This control works in conjunction with the other preamp controls in determining how hard the “power amp” is driven. The Power Reduction is engaged when this control is pulled out slightly until it clicks.

15. POWER REDUCTION POWER: This control sets the output level of the simulated tube power amp section. This allows you to obtain the desired amount of “tube power amp growl” at any volume.

16. MASTER: Use this control to adjust the overall level of the amplifier.

17. LIMIT: The SVT-8 PRO employs an internal limiter to help prevent overdriving the power amp. This LED illuminates when the Limiter is activated, indicating that the levels are near clipping. Reduce the Master control (#16) if this LED illuminates continuously while playing.

18. FAULTY: This LED illuminates when faulty conditions cause the amplifier to protect itself against damages. If this LED should illuminate while playing, turn the amplifier off, wait ten seconds, then turn the amplifier back on. If the Fault LED continues to illuminate refer the amplifier to a qualified Ampeg service center.

19. POWER: Use this switch to turn the amplifier on (top of the switch depressed) and off (bottom of the switch depressed). The adjacent LED illuminates when the amplifier is turned on.



The Rear Panel

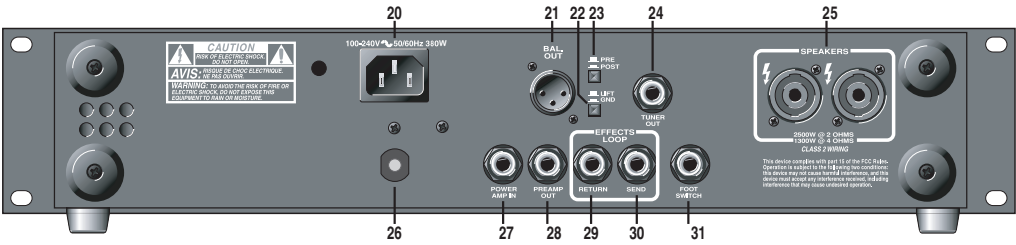

20. AC LINE IN: Firmly insert the supplied AC power cord into this socket until it is fully seated. Plug the male end of the cord into a grounded AC outlet. **DO NOT DEFEAT THE GROUND PRONG OF THE AC PLUG!**

21. BAL. OUT: This jack supplies a line level signal for connection to a house mixing board, recording console or external amplifier. The signal level at this jack is governed by the Post/Pre switch (#23).

22. GND/LIFT: Use this switch to lift the ground connection at the Bal. Out jack to help eliminate hum in the Bal. Out signal.

23. POST/PRE: The signal at the Bal. Out jack (#21) can be set to either Pre or Post-EQ with this switch. With the switch in the OUT position, the signal at the jacks is Pre-EQ. This is a direct output not affected by any EQ or boost settings. With the switch depressed, the signal is Post-EQ and is controlled and modified by the tone controls and the effects loop.

24. TUNER OUT: This jack is provided for connection to an electronic tuner and is always "live," even when the Mute switch (#3) is engaged. This allows for "silent tuning" as well as a monitor feed which stays hot even when the house mix is muted.

25. SPEAKERS: These output jacks supply speaker-level power to the speaker cabinet. The rated power output is 1300 watts rms into 4 ohms or 2500 watts rms into 2 ohms (minimum load).

WARNING: Use speaker cables to make the connections. Do not use instrument cables as they may overheat.

Pin 1+ = hot
Pin 1- = return

26. CIRCUIT BREAKER: The SVT-8 PRO employs an AC line circuit breaker to help protect against damages due to excessive current demands. If the amplifier stops working, check the circuit breaker.

27. POWER AMP IN: This jack connects an external preamp directly to the power amp. When using an external source, connect the output of the source to this jack by means of a shielded signal cable to feed the signal into the power amp section. The internal signal is disconnected when a connector is inserted into this jack.

28. PREAMP OUT: Use this jack to send a signal from the internal preamp to an auxiliary power amplifier, mixing console, monitor system, or house PA system. The signal at this jack is post-EQ.

29. EFFECTS LOOP RETURN: When using an external signal processor, connect the output of the device to this jack by means of a shielded signal cable.

30. EFFECTS LOOP SEND: When using an external signal processor, connect this jack to the input of the device by means of a shielded signal cable.

31. FOOTSWITCH: Connect a two-button (ring/tip/sleeve) footswitch to this jack to control the Power Reduction and the Mute functions. (Mute = tip/sleeve; Power Reduction = ring/sleeve.)

NOTE: A footswitch may be purchased at your local Ampeg Dealer or ordered directly from LOUD Technologies Inc. Be sure to ask for model #AFP2.

***IMPORTANT:** This unit employs forced air cooling by means of an internal fan. The rear and side ventilation slots must remain unobstructed when operating this amplifier. When mounting the unit in a rack make sure there is ample room for proper air circulation. The rack must be constructed and positioned in such a manner to allow proper air flow and the exhausting of hot air away from the rack at all times.*



Some Suggested Settings

Ampeg Rock:

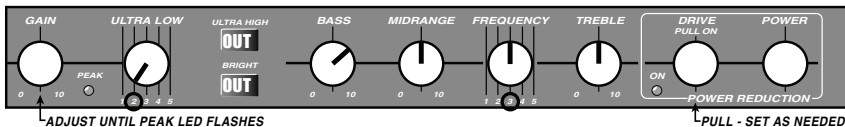

Jazz:

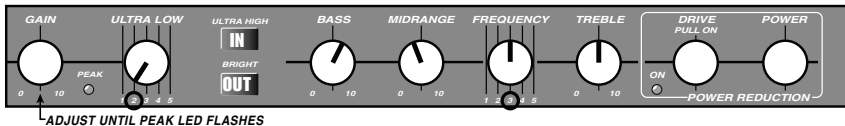

Country:

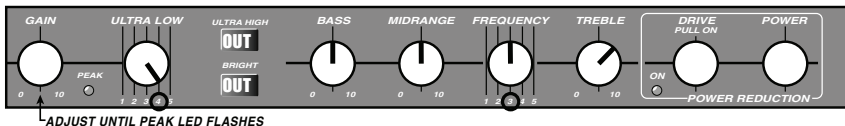

Funk:

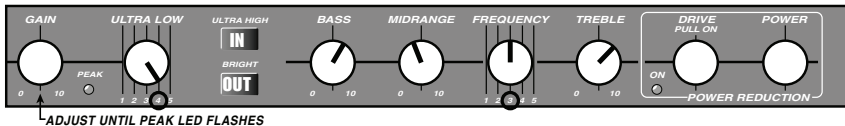

Funk Popping:

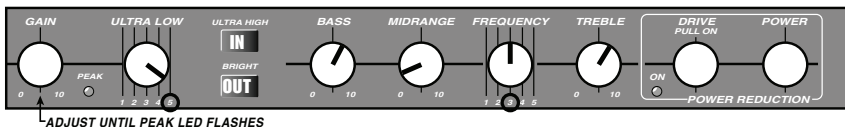

Rack Mounting

When mounting the SVT-8 PRO into a rack, the four bottom feet should be removed to maintain the two rack space height of the amplifier. Be sure to keep the feet and their attachment bolts for future use. If the feet are reinstalled, never use screws which will protrude farther into the amplifier than the original hardware!

The rack must be a high quality enclosure capable of securely supporting the weight of the amplifier. Tighten the mounting screws securely through the amplifier's face plate, into the rack rails. Check the rack and mounting screws occasionally to ensure a continual safe and secure installation. Additional rack ears are provided on the rear of the amplifier for connection to an additional support bracket. It is highly recommended that this additional support be used when rack mounting the amplifier.



Troubleshooting

In the unlikely event that your SVT-8 PRO should malfunction, take a few minutes to troubleshoot it before you call for service. You can save yourself time and money by doing it yourself, and often the cure for the problem is something quite simple.

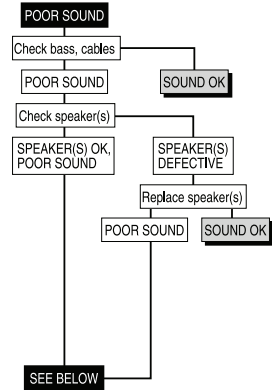
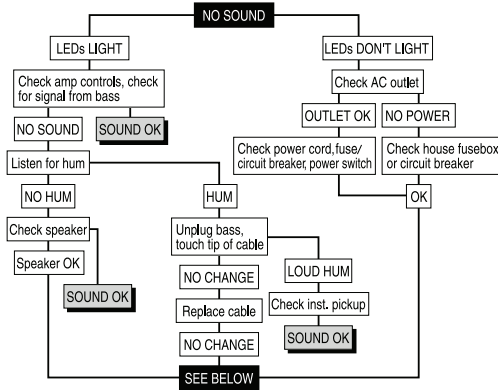

If the problem isn't covered above, or if the steps lead you here, then contact your Ampeg dealer for service information. Also, you should refer your amp for servicing if it gets dropped, has liquid spilled into it, or sustains damage to its power cord (see page 2). Regular maintenance and cleaning should be performed on a routine basis to prolong the amplifier's useful life.

System Block Diagram

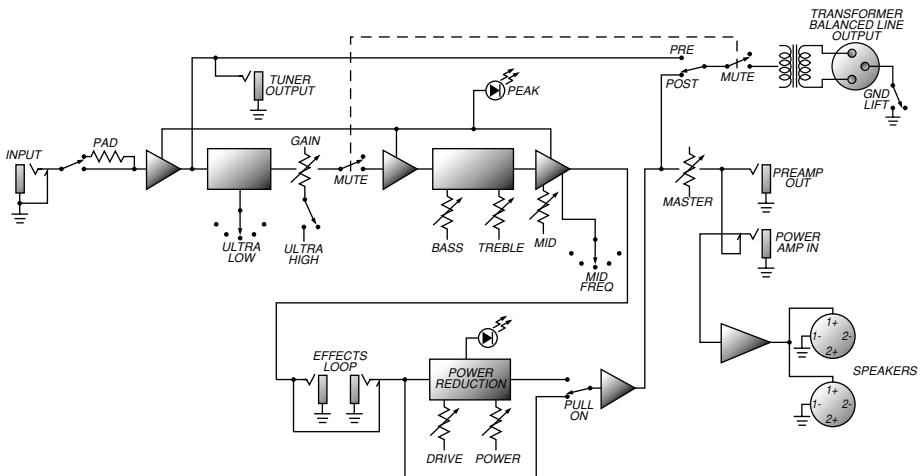



Technical Specifications

OUTPUT POWER RATING	1300 Watts RMS, 4 ohm load, 120VAC, 5% THD 2500 Watts RMS, 2 ohm load, 120VAC, 5% THD
TONE CONTROL RANGE	ULTRA LOW: 1 = off; 2 = -3dB @ 30Hz; 3 = -3dB @ 200Hz; 4 = -20dB @ 600Hz; 5 = +9dB @ 30Hz ULTRA HIGH: +16dB @ 8kHz BRIGHT: +6dB @ 3kHz BASS: +17dB / -13dB @ 20Hz MID FREQ: +/-20dB @ 220Hz, 450Hz, 800Hz, 1.6kHz, or 3kHz TREBLE: +15dB / -20dB @ 7kHz
GAIN	74dB
SIGNAL TO NOISE RATIO	80dB typical
TUBE COMPLEMENT	(2) 12AX7, (1) 12AU7
POWER REQUIREMENTS	100-240VAC, 50/60Hz, 380W
SIZE AND WEIGHT	19 / 17.4" W x 4" H (w/feet) x 18" D; 23 lbs

Ampeg reserves the right to change specifications without notice.



www.ampeg.com

Designed by Ampeg in the USA

©2008 LOUD Technologies Inc. • 16220 Wood-Red Rd. NE • Woodinville, WA 98072 USA

Download from www.Scribd.com All Other Texts Search And Download.
P/N SW0875 F00 • 09/10



Free Manuals Download Website

<http://myh66.com>

<http://usermanuals.us>

<http://www.somanuals.com>

<http://www.4manuals.cc>

<http://www.manual-lib.com>

<http://www.404manual.com>

<http://www.luxmanual.com>

<http://aubethermostatmanual.com>

Golf course search by state

<http://golfingnear.com>

Email search by domain

<http://emailbydomain.com>

Auto manuals search

<http://auto.somanuals.com>

TV manuals search

<http://tv.somanuals.com>