

# VNA Master™

## Handheld Vector Network Analyzer + Spectrum Analyzer

<b>MS2026C</b> 5 kHz to 6 GHz	<b>MS2036C</b> 5 kHz to 6 GHz 9 kHz to 9 GHz	<b>MS2028C</b> 5 kHz to 20 GHz	<b>MS2038C</b> 5 kHz to 20 GHz 9 kHz to 20 GHz	Vector Network Analyzer + Spectrum Analyzer
----------------------------------	--	-----------------------------------	--	--

The Ultimate Handheld Vector Network + Spectrum Analyzer  
for Cable, Antenna and Signal Analysis Anytime, Anywhere

### Introduction

#### High Performance Handheld S-Parameters

Anritsu introduces the MS202x/3xC VNA Master + Spectrum Analyzer, the industry's broadest frequency handheld solution to address cable, antenna, component and signal analysis needs in the field: with frequency coverage from 5 kHz to 6/20 GHz. Equally impressive, this broadband measurement tool offers the industry's first 12-term error correction algorithm in a truly handheld, battery-operated, rugged multi-function instrument. And now the MS2036/38C models include a powerful spectrum analyzer which multiplies user convenience by combining spectrum analysis with the VNA into a single measurement powerhouse for the harsh RF and physical environments of field test. Whether it is for spectrum monitoring, broadcast proofing, interference analysis, RF and microwave measurements, regulatory compliance, or 3G/4G and wireless data network measurements, this VNA/Spectrum Analyzer marriage is the ideal instrument to making fast and reliable measurements in the field.



## Performance and Functional Highlights

### VNA Master

- Broadband coverage of 5 kHz to 6/20 GHz
- True 2-port Vector Network Analyzer (VNA)
- Ultimate accuracy with 12-term error correction
- User-defined quad display for viewing all 4 S-Parameters
- Arbitrary data points up to 4001
- IF Bandwidth selections of 10 Hz to 100 kHz
- 85 dB dynamic range to 20 GHz
- Supports waveguide measurements
- 350  $\mu$ s/data point sweep speed
- USB/Ethernet for PC data transfer and control
- Automate repetitive tasks via Ethernet & USB
- Field upgradable firmware
- Store more than 4000 traces and setups in memory
- Portable: 10.5 lbs (4.8 kg)
- Full Speed USB Memory support
- High resolution daylight viewable TFT color display
- Time Domain option for Distance-to-Fault diagnostics
- Internal Bias Tee option
- Vector Voltmeter option
- High Accuracy Power Meter option
- Differential option ( $S_{d1d1}$ ,  $S_{c1c1}$ ,  $S_{d1c1}$ , and  $S_{c1d1}$ )
- Secure Data Operation option
- GPS Receiver option
- Power Monitor option
- Polar Format Impedance Display
- 4, 6, 8, 18, 26 GHz USB Power Sensors
- 8.4 in. Display

### VNA Master + Spectrum Analyzer

*All of the above VNA features PLUS:*

- Measure: Occupied Bandwidth, Channel Power, ACPR, C/I
- Dynamic Range: > 104 dB in 1 Hz RBW
- DANL: -160 dBm in 1 Hz RBW
- Phase Noise: -100 dBc/Hz @ 10 kHz offset at 1 GHz
- Frequency Accuracy:  $< \pm 25$  ppb with GPS On
- 1 Hz to 10 MHz Resolution Bandwidth (RBW)
- Traces: Normal, Max Hold, Min Hold, Average, # of Averages
- Detectors: Peak, Negative, Sample, Quasi-peak, and true RMS
- Markers: 6, each with a Delta Marker, or 1 Reference with 6 Deltas
- Limit Lines: up to 40 segments with one-button envelope creation
- Trace Save-on-Event: crossing limit line or sweep complete
- Option to automatically optimize sweep-RBW-VBW tradeoff for best possible display
- Interference Analyzer Option: Spectrogram, Signal Strength, RSSI
- Channel Scanner Option
- Zero-span IF Output
- Gated Sweep
- GPS tagging of stored traces
- Internal Preamplifier standard
- High Accuracy Power Meter Option
- AM/FM/SSB Demodulation (audio only)

# VNA Master Functional Specifications

## Definitions

- All specifications and characteristics apply under the following conditions, unless otherwise stated:
- After 30 minutes of warm-up time, where the instrument is in VNA Mode and left in the ON state.
- Temperature range is  $23\text{ }^{\circ}\text{C} \pm 5\text{ }^{\circ}\text{C}$ .
- All specifications apply when using internal reference.
- All specifications subject to change without notice. Please visit [www.us.anritsu.com](http://www.us.anritsu.com) for most current data sheet.
- Typical performance is the measured performance of an average unit.
- Recommended calibration cycle is 12 months.

## Frequency

VNA Master Frequency Range: MS2026/36C: 5 kHz to 6 GHz  
 MS2028/38C: 5 kHz to 20 GHz

Frequency Accuracy: 1.5 ppm

Frequency Resolution: 1 Hz to 375 MHz, 10 Hz to 6 GHz, and 100 Hz to 20 GHz

## Typical Test Port Power

VNA Master supports selection of either High (default) or Low test port power. Changing power after calibration can degrade the calibrated performance. Typical power by bands is shown in the following table.

Frequency Range	High Port Power (dB)	Low Port Power (dBm)
5 kHz to $\leq$ 3 GHz	+3	-25
3 GHz to $\leq$ 6 GHz	-3	-25
6 GHz to $\leq$ 20 GHz	-3	-15

## Transmission Dynamic Range

The transmission dynamic range (the difference between test port power and noise floor) using 10 Hz IF Bandwidth and High Port Power is shown in the following table.

Frequency Range	Dynamic Range (dB)
5 kHz to $\leq$ 2 MHz	85
2 MHz to $\leq$ 3 GHz	100
3 GHz to $\leq$ 6 GHz	90
6 GHz to $\leq$ 20 GHz	85

## Typical Sweep Speed

The typical sweep speed for IF Bandwidth of 100 kHz, 1001 data points, and single display is shown in the following table. The three receiver architecture will simultaneously collect  $S_{21}$  and  $S_{11}$  (or  $S_{12}$  and  $S_{22}$ ) in a single sweep.

Frequency Range	Typical Sweep Speed ( $\mu\text{s}/\text{point}$ )
5 kHz to 6 GHz	350
6 GHz to 20 GHz	650

## Block Diagram

As shown in the following block diagram, the VNA Master has a 2-port, 2-path architecture that automatically measures four S-parameters with a single connection.

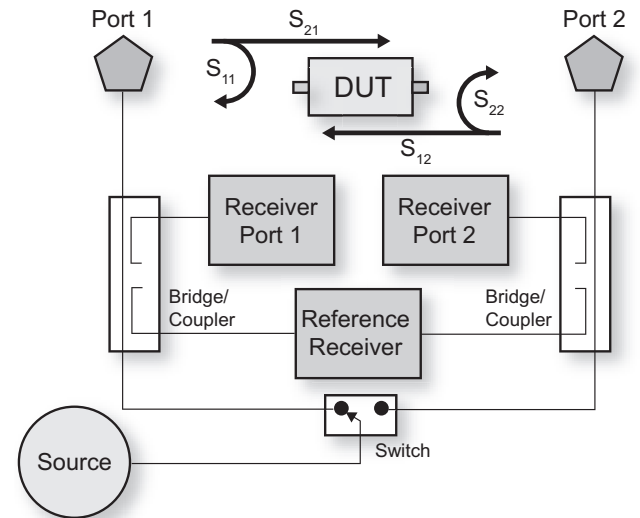

The above illustration is a simplified block diagram of VNA Master's 2-port, 2-path architecture.

## Uncertainty Curves for Round-Trip Cable Loss Measurements (1-Port)

Round-trip cable loss measurements are convenient for field personnel testing installed cable or waveguide runs. This one-port technique provides one-way data after twice traversing the cable. The following two sets of uncertainty curves, less than 6 GHz on the left and greater than 6 GHz on the right, present worst-case uncertainty by DUT Match (i.e., Log Mag) when using VNA Master for one-port cable loss measurements. As a practical tip, consider using a two-port transmission measurement technique to improve upon these one-port cable loss uncertainties.

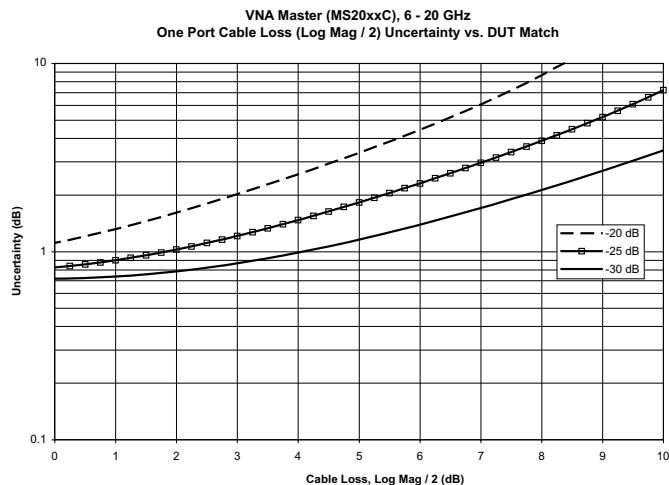
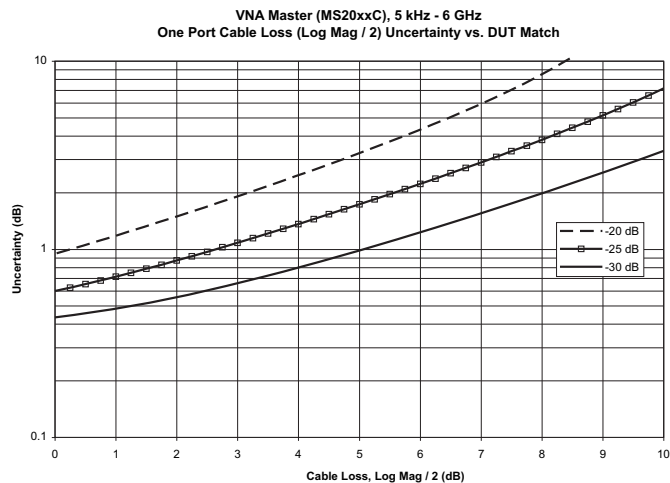

These uncertainty curves show how frequency range, DUT Match, and cable loss impact worst-case uncertainty of round-trip cable loss measurements. The uncertainty curves, separated by frequency range, are shown for DUT Match conditions of 20, 25, and 30 dB. For DUT Match of 30 dB and cable loss of 4-5 dB (reflection measurement of 8-10 dB) the worst-case uncertainties are approximately  $\pm 1$  dB.

# High Port Power

OSLxx50 Calibration Components (N-Connectors)

Corrected System Performance and Uncertainties:  
 MS202x/3xC Model with 12-term SOLT calibration including  
 isolation using either OSLN50 & OSLNF50 or OSLK50 &  
 OSLKF50 Calibration Kits



*Precision calibration standards come in a convenient configuration for field work.*

Frequency Range (GHz)	Directivity (dB)
≤ 5	> 42
≤ 15	> 36
≤ 20*	> 32

\* N Connector guaranteed to 18 GHz, typical > 18 GHz

Frequency Range (GHz)	Typical High Port Power (dBm)
≤ 3	+3
≤ 6	-3
≤ 20	-3

## Measurement Uncertainties

The following graphs provide measurement uncertainty at 23 °C ± 5 °C for the above indicated connector type and calibration. Errors are worse-case contributions of residual directivity, source match, frequency response, network analyzer dynamic range, and connector repeatability. For two-port measurements, transmission tracking, crosstalk, and physical load match termination were added. Isolation calibration and an IF Bandwidth of 10 Hz is used.

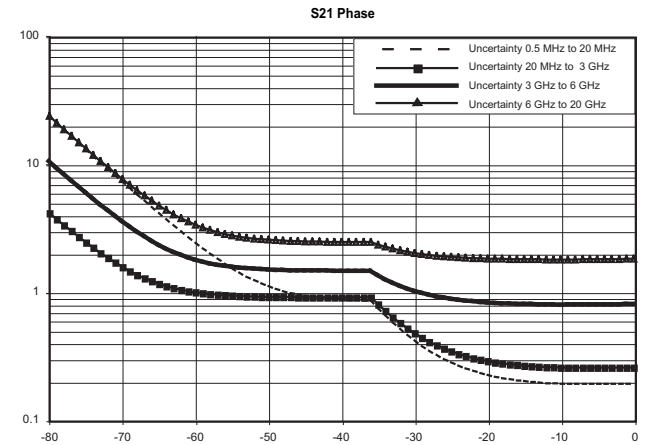
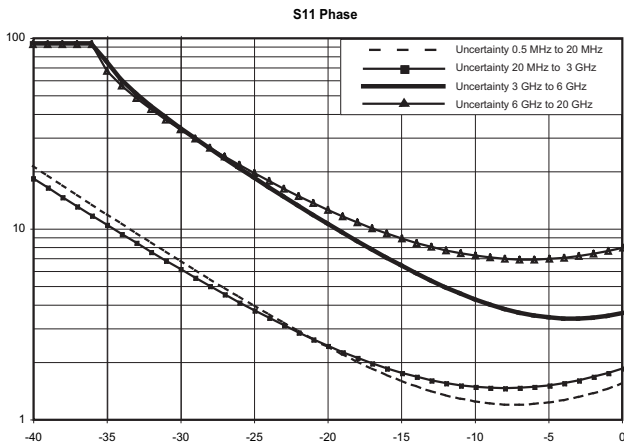
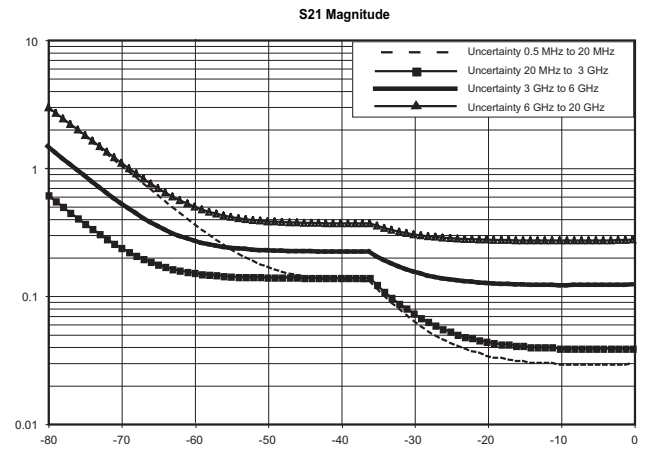
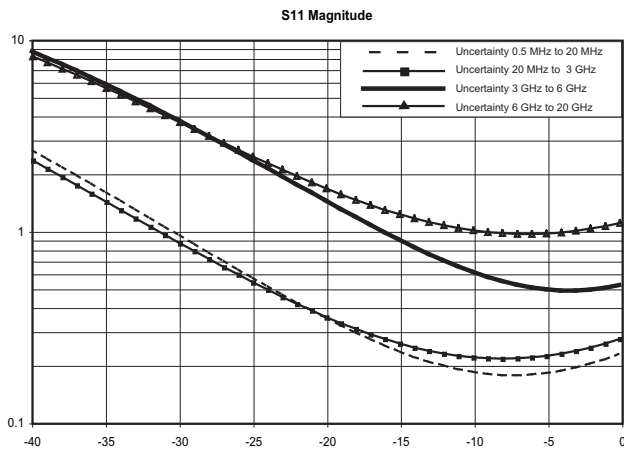

## Low Port Power

OSLxx50 Calibration Components

Corrected System Performance and Uncertainties:  
MS202x/3xC Model with 12-term SOLT calibration including  
isolation using either OSLN50 & OSLNF50 or OSLK50 &  
OSLKF50 Calibration Kits



Frequency Range (GHz)	Directivity (dB)
≤ 5	> 42
≤ 15	> 36
≤ 20*	> 32

\* N Connector guaranteed to 18 GHz, typical > 18 GHz

Frequency Range (GHz)	Typical High Port Power (dBm)
≤ 3	-25
≤ 6	-25
≤ 20	-15

### Measurement Uncertainties

The following graphs provide measurement uncertainty at  $23\text{ °C} \pm 5\text{ °C}$  for the above indicated connector type and calibration. Errors are worse-case contributions of residual directivity, source match, frequency response, network analyzer dynamic range, and connector repeatability. For two-port measurements, transmission tracking, crosstalk, and physical load match termination were added. Isolation calibration and an IF Bandwidth of 10 Hz is used.

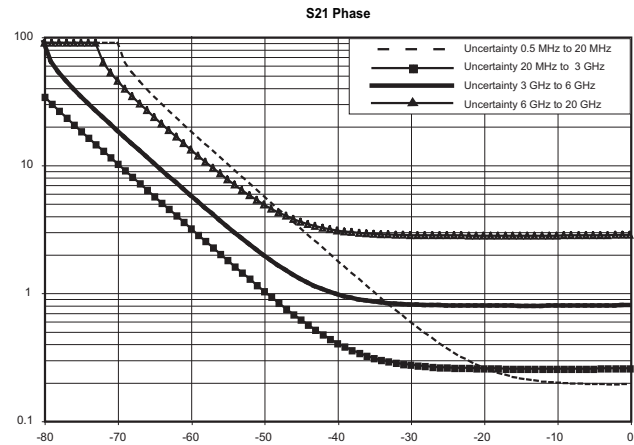
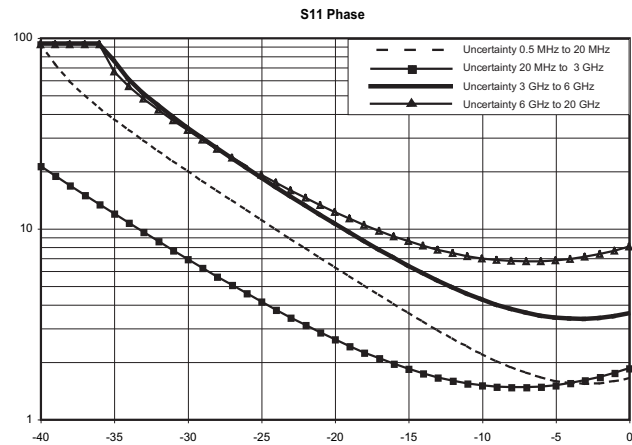
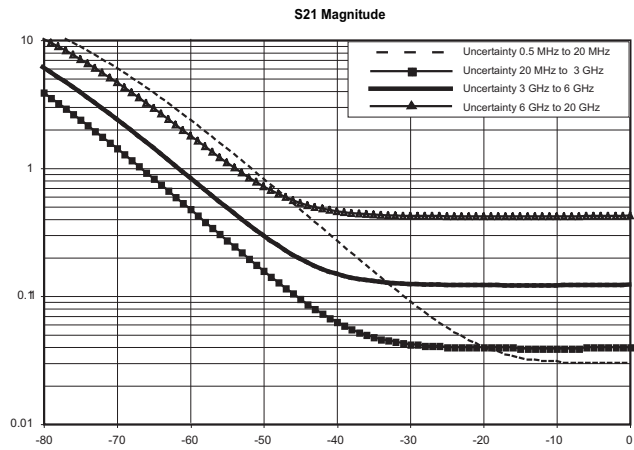
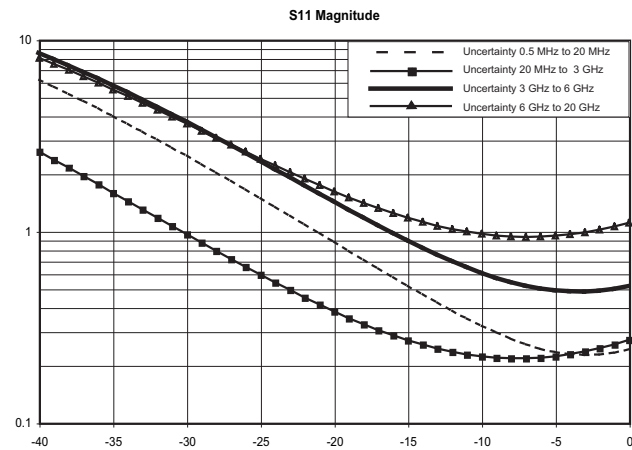

# High Port Power

3652A Calibration Kit (K-Connector)

Corrected System Performance and Uncertainties:  
MS202x/3xC Model with 12-term SOLT calibration including  
isolation using 3652A Calibration Kit



Frequency Range (GHz)	Directivity (dB)
≤ 5	> 42
≤ 15	> 36
≤ 20*	> 32

\* N Connector guaranteed to 18 GHz, typical > 18 GHz

Frequency Range (GHz)	Typical High Port Power (dBm)
≤ 3	+3
≤ 6	-3
≤ 20	-3

## Measurement Uncertainties

The following graphs provide measurement uncertainty at 23 °C ± 5 °C for the above indicated connector type and calibration. Errors are worse-case contributions of residual directivity, source match, frequency response, network analyzer dynamic range, and connector repeatability. For two-port measurements, transmission tracking, crosstalk, and physical load match termination were added. Isolation calibration and an IF Bandwidth of 10 Hz is used.

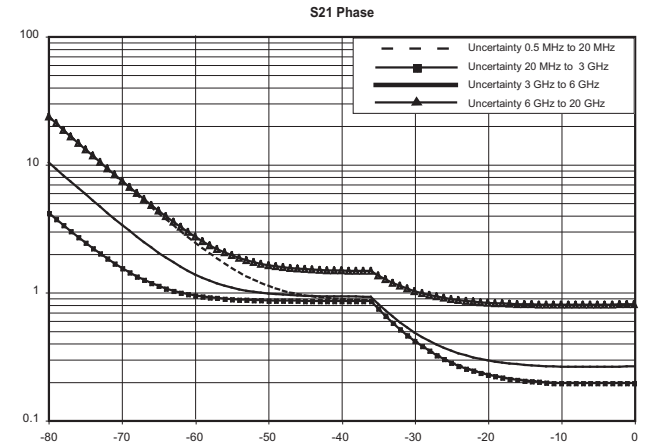
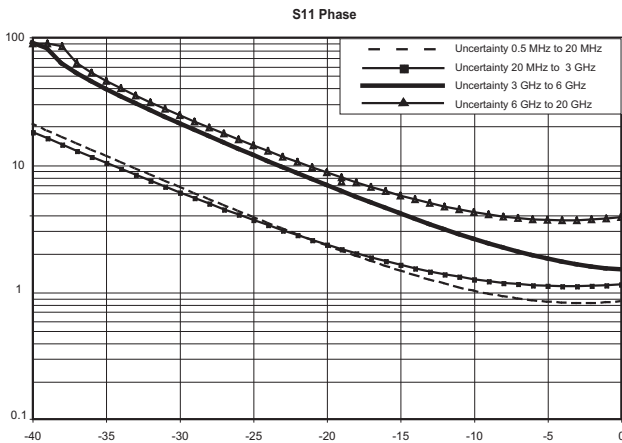
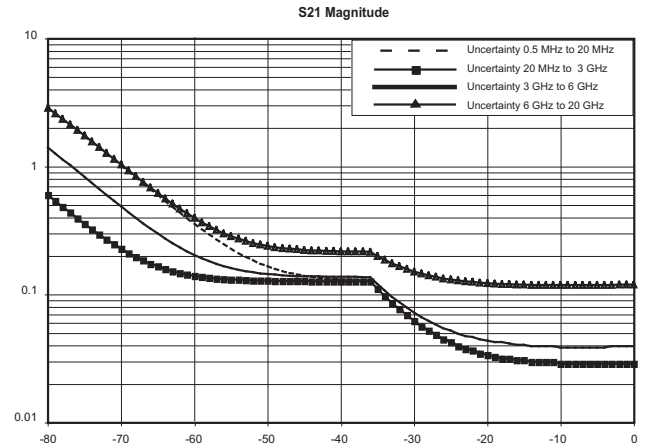
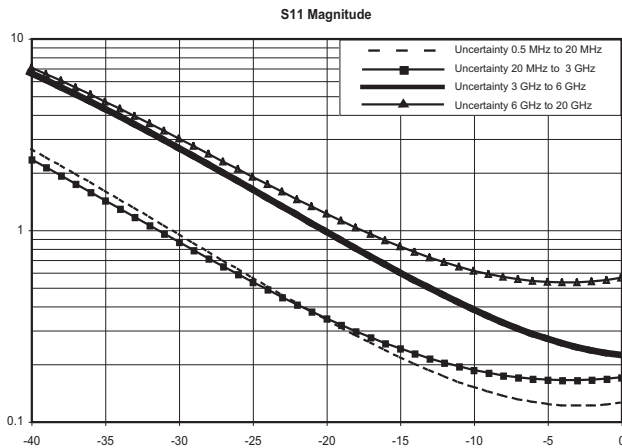



## Low Port Power

### 3652A Calibration Kit (K-Connector)

Corrected System Performance and Uncertainties:  
MS202x/3xC Model with 12-term SOLT calibration including  
isolation using 3652A Calibration Kit



Frequency Range (GHz)	Directivity (dB)
≤ 5	> 42
≤ 15	> 36
≤ 20*	> 32

\* N Connector guaranteed to 18 GHz, typical > 18 GHz

Frequency Range (GHz)	Typical Low Port Power (dBm)
≤ 3	-25
≤ 6	-25
≤ 20	-25

### Measurement Uncertainties

The following graphs provide measurement uncertainty at 23 °C ± 5 °C for the above indicated connector type and calibration. Errors are worse-case contributions of residual directivity, source match, frequency response, network analyzer dynamic range, and connector repeatability. For two-port measurements, transmission tracking, crosstalk, and physical load match termination were added. Isolation calibration and an IF Bandwidth of 10 Hz is used.

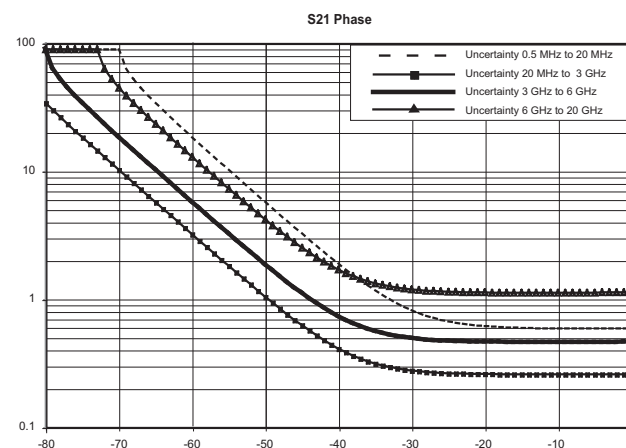
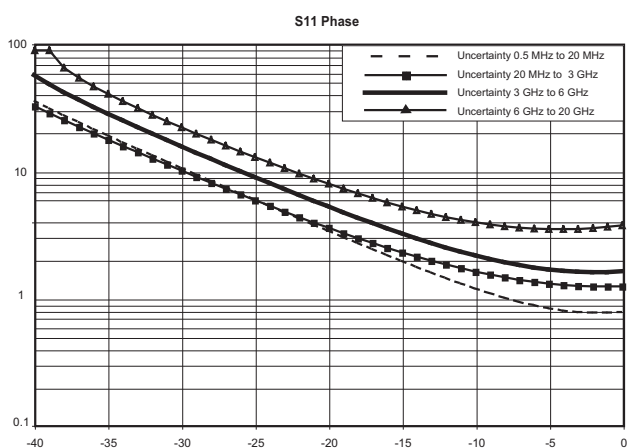
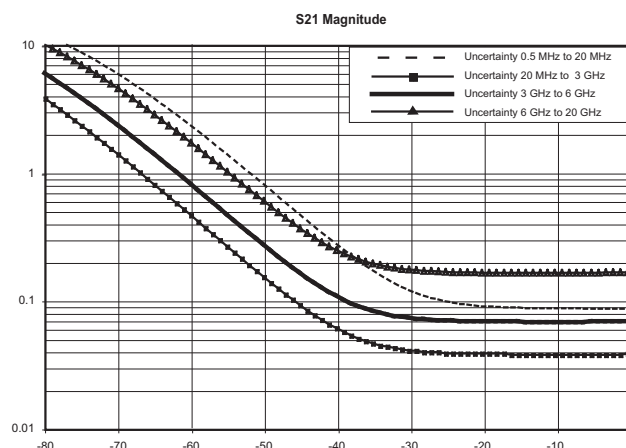
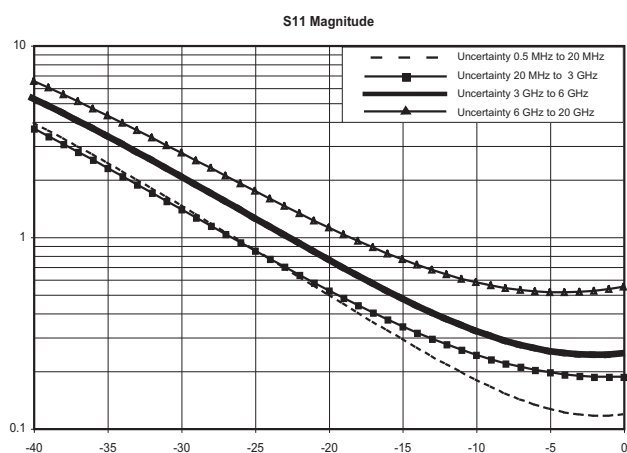



## + Spectrum Analyzer Functional Specifications (Models MS2036/38C only)

<b>Frequency</b>	
Frequency Range	9 kHz to 20 GHz (usable to 0 Hz), Preamp 100 kHz to 20 GHz
Tuning Resolution	1 Hz
Frequency Reference	Aging: $\pm 1.0$ ppm/10 years Accuracy: $\pm 0.3$ ppm (25 °C $\pm$ 25 °C) + aging
External Reference Frequencies	1, 1.2288, 1.544, 2.048, 2.4576, 4.8, 4.9152, 5, 9.8304, 10, 13, 19.6608 MHz
Frequency Span	10 Hz to 20 GHz including zero span
Sweep Time	10 $\mu$ s to 600 seconds in zero span
Sweep Time Accuracy	$\pm 2\%$ in zero span
<b>Bandwidth</b>	
Resolution Bandwidth (RBW)	1 Hz to 10 MHz in 1–3 sequence $\pm 10\%$ (–3 dB bandwidth)
Video Bandwidth (VBW)	1 Hz to 10 MHz in 1–3 sequence (–3 dB bandwidth)
RBW with Quasi-Peak Detection	200 Hz, 9 KHz, 120 kHz (–6 dB bandwidth)
VBW with Quasi-Peak Detection	Auto VBW is On, RBW/VBW = 1
<b>Spectral Purity</b>	
SSB Phase Noise at 1 GHz	–100 dBc/Hz @ 10 kHz offset from carrier (–104 dBc/Hz typical) –102 dBc/Hz @ 100 kHz offset from carrier (–107 dBc/Hz typical) –107 dBc/Hz @ 1 MHz offset from carrier (–114 dBc/Hz typical) –120 dBc/Hz @ 10 MHz offset from carrier (–129 dBc/Hz typical)
<b>Amplitude Ranges</b>	
Dynamic Range	> 104 dB @ 2.4 GHz, 2/3 (TOI-DANL) in 1 Hz RBW
Measurement Range	DANL to +30 dBm
Display Range	1 to 15 dB/div in 1 dB steps, ten divisions displayed
Reference Level Range	–120 dBm to +30 dBm
Attenuator Resolution	0 to 65 dB, 5 dB steps
Amplitude Units	Log Scale Modes: dBm, dBV, dBmV, dB $\mu$ V Linear Scale Modes: nV, $\mu$ V, mV, V, kV, nW, $\mu$ W, mW, W, kW
Maximum Continuous Input	+30 dBm Peak, $\pm 50$ VDC ( $\geq 10$ dB Attn) +23 dBm Peak, $\pm 50$ VDC (< 10 dB Attn) +13 dBm Peak, $\pm 50$ VDC (Preamp On)
<b>Amplitude Accuracy</b> (single sine wave input < Ref level, and > DANL, auto attenuation)	
20 °C to 30 °C after 30 minute warm-up	Typical: $\pm 0.5$ dB, 100 kHz to 20 GHz Maximum: $\pm 1.3$ dB, 100 kHz to 13 GHz Add $\pm 1.0$ dB, 13 GHz to 20 GHz
–10 °C to 50 °C after 60 minute warm-up	Add $\pm 1.0$ dB, 100 kHz to 20 GHz
<b>Displayed Average Noise Level (DANL)</b> (RMS detection, VBW/Avg type = Log., Ref Level = –20 dBm for preamp Off and –50 dBm for preamp On)	
(DANL in 1 Hz RBW, 0 dB attenuation)	Preamp Off
10 MHz to 4 GHz	–141 dBm
> 4 GHz to 9 GHz	–134 dBm
> 9 GHz to 13 GHz	–129 dBm
> 13 GHz to 20 GHz	–123 dBm (MS2038C only)
	Preamp On
10 MHz to 4 GHz	–160 dBm
> 4 GHz to 9 GHz	–156 dBm
> 9 GHz to 13 GHz	–152 dBm
> 13 GHz to 20 GHz	–145 dBm

## + Spectrum Analyzer Functional Specifications (Models MS2036/38C only) (continued)

Spurs	
Residual Spurious	Preamp Off (RF input terminated, 0 dB input attenuation) -90 dBm 9 kHz to 13 GHz -85 dBm 13 GHz to 20 GHz
	Preamp On (RF input terminated, 0 dB input attenuation) -100 dBm 1 MHz to 20 GHz
Input-Related Spurious	(0 dB attenuation, -30 dBm input, span < 1.7 GHz) -60 dBc, -70 dBc typical
<b>Third-Order Intercept (TOI)</b> (-20 dBm tones 100 kHz apart, -20 dBm Ref level, 0 dB input attenuation, preamp Off)	
2.4 GHz	+15 dBm
50 MHz to 20 GHz	+20 dBm typical
<b>P1dB</b>	
< 4 GHz	+5 dBm typical
4 GHz to 20 GHz	+12 dBm typical
<b>Second Harmonic Distortion</b>	
50 MHz	-54 dBc
< 4 GHz	-60 dBc typical
> 4 GHz	-75 dBc typical
<b>VSWR</b>	
> 10 dB input attenuation < 20 GHz	1:5:1 typical

## VNA Performance Capabilities (MS202x/3xC)

Measurement Parameters	$S_{11}$ , $S_{21}$ , $S_{22}$ , $S_{12}$ , $S_{d1d1}$ , $S_{c1c1}$ , $S_{d1c1}$ , $S_{c1d1}$
Number of Traces	Four: TR1, TR2, TR3, TR4
Trace Format	Single, Dual, Tri, Quad. When used with Number of Traces, overlays are possible including a Single Format with Four trace overlays.
Graph Types	Log Magnitude SWR Phase Real Imaginary Group Delay Smith Chart Log Mag / 2 (1-Port Cable Loss) Linear Polar Log Polar Real Impedance Imaginary Impedance
Domains	Frequency Domain, Time Domain, Distance Domain
Frequency	Start Frequency, Stop Frequency, Center Frequency, Span
Distance	Start Distance, Stop Distance
Time	Start Time, Stop Time
Frequency Sweep Type: Linear	Single Sweep, Continuous
Data Points	2 to 4001 (arbitrary setting); data points can be reduced without recalibration.
Limit Lines	Upper, Lower, 10 segmented Upper, 10 segmented Lower
Test Limits	Pass/Fail for Upper, Pass/Fail for Lower, Limit Audible Alarm
Data Averaging	Sweep-by-sweep
Smoothing	0 to 20%
IF Bandwidth	10, 30, 100, 300, 1k, 3k, 10k, 30k, 100k (Hz)
Reference Plane	The reference planes of a calibration (or other normalization) can be changed by entering a line length. Assumes no loss, flat magnitude, linear phase, and constant impedance.
Auto Reference Plane Extension	Instead of manually entering a line length, this feature automatically adjusts phase shift from the current calibration (or other normalization) to compensate for external cables (or test fixtures). Assumes no loss, flat magnitude, linear phase, and constant impedance.
Frequency Range	Frequency range of the measurement can be narrowed within the calibration range without recalibration.
Group Delay Aperture	Defined as the frequency span over which the phase change is computed at a given frequency point. The aperture can be changed without recalibration. The minimum aperture is the frequency range divided by the number of points in calibration and can be increased to 20% of the frequency range.
Group Delay Range	< 180° of phase change within the aperture
Trace Memory	A separate memory for each trace can be used to store measurement data for later display. The trace data can be saved and recalled.
Trace Math	Complex trace math operations of subtraction, addition, multiplication, or division are provided.
Number of Markers	Eight, arbitrary assignments to any trace
Marker Types	Reference, Delta
Marker Readout Styles	Log Mag, Cable Loss (Log Mag / 2), Log Mag and Phase, Phase, Real and Imaginary, SWR, Impedance, Admittance, Normalized Impedance, Normalized Admittance, Polar Impedance, and Group Delay, Linear Mag, Linear Mag and Phase
Marker Search	Peak Search, Valley Search, Find Marker Value
Correction Models	Full 2-Port, Full $S_{11}$ , Full $S_{22}$ , Full $S_{11}$ & $S_{22}$ , Response $S_{21}$ , Response $S_{12}$ , Response $S_{21}$ & $S_{12}$ , Response $S_{11}$ , Response $S_{22}$ , Response $S_{11}$ & $S_{22}$ , One-Path Two-Port ( $S_{11}, S_{21}$ ), One-Path Two-Port ( $S_{22}, S_{12}$ )
Calibration Methods	Short-Open-Load-Through (SOLT), Offset-Short (SSLT), and Triple-Offset-Short (SSST)
Calibration Standards' Coefficients	Coax: N-Connector, K-Connector, 7/16, TNC, SMA, and four User Defined Waveguide: WG11A, WG12, WG13, WG14, WG15, WG16, WG17, WG18, WG20, and four User Defined
Cal Correction Toggle	On/Off
Dispersion Compensation	Waveguide correction that improves accuracy of distance-to-fault data by compensating for different wavelengths propagating at different speeds.
Impedance Conversion	Support for 50 $\Omega$ and 75 $\Omega$ are provided.
Units	Meters, Feet
Bias Tee Settings	Internal, External, Off
Timebase Reference	Internal, External (10 MHz)
File Storage Types	Measurement, Setup (with CAL), Setup (without CAL), S2P (Real/Imag), S2P (Lin Mag/Phase), S2P (Log Mag/Phase), JPEG
Ethernet Configuration	DHCP or Manual (Static); IP, Gateway, Subnet entries
Languages	English, French, German, Spanish, Chinese, Japanese, Korean, Italian, plus two User Defined

## + Spectrum Analyzer Performance Capabilities

Measurements	
Smart Measurements	Field Strength (uses antenna calibration tables to measure dBm/m <sup>2</sup> or dBmV/m) Occupied Bandwidth (measures 99% to 1% power channel of a signal) Channel Power (measures the total power in a specified bandwidth) ACPR (adjacent channel power ratio) C/I (carrier-to-interference ratio) Emission Mask (recall limit lines as emission mask)
Setup Parameters	
Frequency	Center/Start/Stop, Span, Frequency Step, Signal Standard, Channel #
Amplitude	Reference Level (RL), Scale, Attenuation Auto/Level, RL Offset, Pre-Amp On/Off, Detection
Span	Span, Span Up/Down (1-2-5), Full Span, Zero Span, Last Span
Bandwidth	RBW, Auto RBW, VBW, Auto VBW, RBW/VBW, Span/RBW
File	Save, Recall, Delete, Directory Management
Save/Recall	Setups, Measurements, Limit Lines, Screen Shots Jpeg (save only), Save-on-Event
Save-on-Event	Crossing Limit Line, Sweep Complete, Save-then-Stop, Clear All
Delete	Selected File, All Measurements, All Mode Files, All Content
Directory Management	Sort Method (Name/Type/Date), Ascend/Descend, Internal/USB, Copy
Application Options	Impedance (50 Ω, 75 Ω, Other)
Sweep Functions	
Sweep	Single/Continuous, Manual Trigger, Reset, Detection, Minimum Sweep Time, Trigger Type
Sweep Mode	Fast, Performance, No FFT
Detection	Peak, RMS/Avg, Negative, Sample, Quasi-peak
Triggers	Free Run, External, Video, Delay, Level, Slope, Hysteresis, Holdoff, Force Trigger Once
Trace Functions	
Traces	Up to three Traces (A, B, C), View/Blank, Write/Hold, Trace A/B/C Operations
Trace A Operations	Normal, Max Hold, Min Hold, Average, # of Averages, (always the live trace)
Trace B Operations	A→B, B↔C, Max Hold, Min Hold
Trace C Operations	A→C, B↔C, Max Hold, Min Hold, A – B→C, B – A→C, Relative Reference (dB), Scale
Marker Functions	
Markers	Markers 1-6 each with a Delta Marker, or Marker 1 Reference with Six Delta Markers, Marker Table (On/Off/Large), All Markers Off
Marker Types	Style (Fixed/Tracking), Noise Marker, Frequency Counter Marker
Marker Auto-Position	Peak Search, Next Peak (Right/Left), Peak Threshold %, Set Marker to Channel, Marker Frequency to Center, Delta Marker to Span, Marker to Reference Level
Marker Table	1-6 markers frequency and amplitude plus delta markers frequency offset and amplitude
Limit Line Functions	
Limit Lines	Upper/Lower, On/Off, Edit, Move, Envelope, Advanced, Limit Alarm, Default Limit
Limit Line Edit	Frequency, Amplitude, Add Point, Add Vertical, Delete Point, Next Point Left/Right
Limit Line Move	To Current Center Frequency, By dB or Hz, To Marker 1, Offset from Marker 1
Limit Line Envelope	Create Envelope, Update Amplitude, Number of Points (41), Offset, Shape Square/Slope
Limit Line Advanced	Type (Absolute/Relative), Mirror, Save/Recall

## Measurement Options Specifications

### Time Domain (Option 0002) (includes Distance Domain Option 0501)

The VNA Master can also display the S-parameter measurements in the time or distance domain using lowpass or bandpass processing analysis modes. The broadband frequency coverage coupled with 4001 data points means you can measure discontinuities both near and far with unprecedented clarity for a handheld tool. With this option, you can simultaneously view S-parameters in frequency, time, and distance domain to quickly identify faults in the field. Advanced features available with this option include step response, phasor impulse, gating, and frequency gated in time. The option includes computational routines that further enhance the Distance Domain results by compensating for cable loss, relative velocity of propagation, and dispersion compensation in waveguide.

Distance Domain	Round-Trip (reflection) Fault Resolution (meters):	$(0.5 \times c \times Vp) / \Delta F$ ; (c is speed of light = 3E8 m/s, $\Delta F$ is F2 – F1 in Hz)
	One-Way (transmission) Fault Resolution (meters):	$(c \times Vp) / \Delta F$ ; (c is speed of light = 3E8 m/s, $\Delta F$ is F2 – F1 in Hz)
	Horizontal Range (meters):	0 to (data points – 1) x Fault Resolution to a maximum of 3000 m (9843 ft.)
	Windowing	Rectangular, Nominal Side Lobe (NSL), Low Side Lobe (LSL), and Minimum Side Lobe (MSL)

### Power Monitor (Option 0005) Requires external detector

Transmitter measurements in the field are possible when using this VNA Master software mode with a separately purchased Anritsu 560 series detector. A variety of detectors are available to 50 GHz, but the popular 560-7N50B covers 10 MHz to 20 GHz with a measurement range of –50 to +20 dBm with better than 0.5 dB flatness to 18 GHz. After zeroing the detector to ensure accuracy at low power levels, the software offers intuitive operation for absolute and relative readouts in dBm or Watts.

Display Range	–80 to +80 dBm (10 pW to 100 kW)
Measurement Range	–50 to +20 dBm (10 nW to 40 mW)
Offset Range	0 to +60 dB
Resolution	0.1 dB, 0.1 xW (x = n, $\mu$ , m based on detector power)
Accuracy	$\pm 1$ dB maximum for >–40 dBm using 560-7N50B detector

### Power Monitor Detectors\* (Ordered separately):

Part Numbers	560-7N50B	560-7S50B
Frequency Range	0.01 to 20 GHz	0.01 to 20 GHz
Impedance	50 $\Omega$	50 $\Omega$
Power Range	–55 dBm to +16 dBm	–55 dBm to +16 dBm
Return Loss	15 dB, < 0.04 GHz 22 dB, < 8 GHz 17 dB, < 18 GHz 14 dB, < 20 GHz	15 dB, < 0.04 GHz 22 dB, < 8 GHz 17 dB, < 18 GHz 14 dB, < 20 GHz
Input Connector	N(m)	WSMA(m)
Frequency Response	$\pm 0.5$ dB, < 18 GHz $\pm 1.25$ dB, < 20 GHz	$\pm 0.5$ dB, < 18 GHz $\pm 1.25$ dB, < 20 GHz

\*See [www.us.anritsu.com](http://www.us.anritsu.com) for additional detectors

### Secure Data Operation (Option 0007)

For highly secure data handling requirements, this software option prevents the storing of measurement setup or data information onto any internal file storage location. Instead, setup and measurement information is stored ONLY to the external USB memory location. A simple factory preset prepares the VNA Master for transportation while the USB memory remains behind in the secure environment. The VNA Master cannot be switched between secure and non-secure operation by the user once configured for secure data operation. As an additional security measure, with this option enabled the user can choose to blank the frequency values displayed on the screen.

## Bias Tee (Option 0010)

For tower mounted amplifier tests, the MS20x/3xC series with optional internal bias tees can supply both DC and RF signals on the center conductor of the cable during measurements. For frequency sweeps in excess of 2 MHz, the VNA Master can supply internal voltage control from +12 to +32 V in 0.1 V steps up to 450 mA. To extend battery life, an external power supply can substitute for the internal supply by using the external bias inputs instead. Both test ports can be configured to supply voltage via this integrated bias tees option. Bias can be directed to VNA Port 1 or Port 2.

Frequency Range	2 MHz to 6 GHz (MS20x6C) 2 MHz to 20 GHz (MS20x8C)
Internal Voltage/Current	+12V to +32V at 450 ma. Steady rate
Internal Resolution	0.1V
External Voltage/Current	±50 V at 500 mA steady rate
Bias Tee Selections	Internal, External, Off

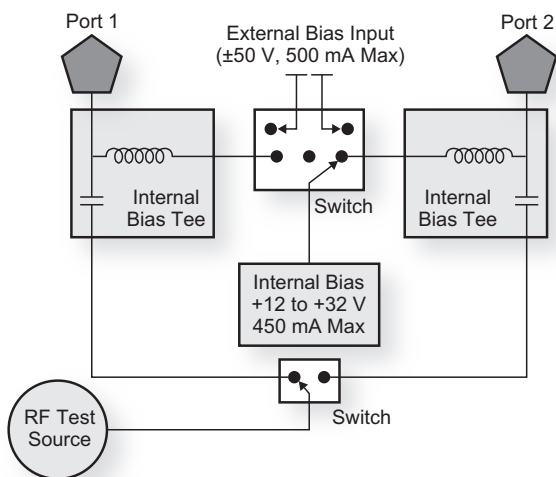

The VNA Master offers optional integrated bias tee for supplying DC plus RF to the DUT as shown in this simplified block diagram. Connectivity is also provided for external supply (instead of internal) to preserve battery consumption.

## Vector Voltmeter (Option 0015)

A phased array system relies on phase matched cables for nominal performance. For this class of application, the VNA Master offers this special software mode to simplify phase matching cables at a single frequency. The similarity between the popular vector voltmeter and this software mode ensures minimal training is required to phase match cables. Operation is as simple as configuring the display for absolute or relative measurements. The easy-to-read large fonts show either reflection or transmission measurements using impedance, magnitude, or VSWR readouts. For instrument landing system (ILS) or VHF Omni-directional Range (VOR) applications, a table view improves operator efficiency when phase matching up to twelve cables. The MS202x/3xC solution is superior because the signal source is included internally, precluding the need for an external signal generator.

CW Frequency Range	5 kHz to 20 GHz
Measurement Display	CW, Table (Twelve Entries, Plus Reference)
Measurement Types	Return Loss, Insertion
Measurement Format	dB/VSWR/Impedance

## High Accuracy Power Meter (Option 0019) Requires external USB power sensor.

Conduct precise measurements of CW and digitally modulated transmitters in the field using this VNA Master software mode with a separately purchased Anritsu USB power sensor. After specifying the center frequency and zeroing the sensor to ensure accuracy at low power levels, the software offers intuitive operation for absolute and relative readouts in dBm or Watts. Option 0019 supports the USB Power Sensors in the following table.

### USB Power Sensors (Ordered separately):

	PSN50	MA24104A	MA24106A	MA24108A	MA24118A
Frequency Range	50 MHz to 6 GHz	600 MHz to 4 GHz	50 MHz to 6 GHz	10 MHz to 8 GHz	10 MHz to 18 GHz
Description	High Accuracy RF Power Sensor	Inline High Power Sensor	High Accuracy RF Power Sensor	Microwave USB Power Sensor	Microwave USB Power Sensor
Connector	Type N, male, 50 Ω	Type N, female, Ω	Type N, male, 50 Ω	Type N, male, 50 Ω	Type N, male, 50 Ω
Dynamic Range	-30 dBm to +20 dBm (0.001 mW to 100 mW)	+3 dBm to +51.76 dBm (2 mW to 150 W)	-40 dBm to +23 dBm (0.1 μW to 200 mW)	-40 dBm to +20 dBm (0.1 μW to 100 mW)	-40 dBm to +20 dBm (0.1 μW to 100 mW)
VBW	100 Hz	100 Hz	100 Hz	50 kHz	50 kHz
Measurement	True-RMS	True-RMS	True-RMS	True-RMS, Slot Power, Burst Average Power	True-RMS, Slot power, Burst Average power
Measurement Uncertainty	±0.16 dB <sup>1</sup>	±0.17 dB <sup>2</sup>	±0.16 dB <sup>1</sup>	±0.18 dB <sup>3</sup>	±0.18 dB <sup>3</sup>
Datasheet for Additional Specifications	11410-00414	11410-00483	11410-00424	11410-00504	11410-00504

Notes:

- 1) Total RSS measurement uncertainty (0 °C to 50 °C) for power measurements of a CW signal greater than -20 dBm with zero mismatch errors
- 2) Expanded uncertainty with K=2 for power measurements of a CW signal greater than +20 dBm with a matched load. Measurement results referenced to the input side of the sensor.
- 3) Expanded uncertainty with K=2 for power measurements of a CW signal greater than -20 dBm with zero mismatch errors

## Interference Analyzer (Option 0025) (Models MS2036/38C only) (Recommend GPS)

Measurements	Spectrum Field Strength Occupied Bandwidth Channel Power Adjacent Channel Power (ACPR) AM/FM/SSB Demodulation (Wide/Narrow FM, Upper/Lower SSB), (audio out only) Carrier-to-Interference ratio (C/I) Spectrogram (Collect data up to one week) Signal Strength (Gives visual and aural indication of signal strength) Received Signal Strength Indicator (RSSI) (collect data up to one week) Gives visual and aural indication of signal strength Signal ID (up to 12 signals) Center Frequency Bandwidth Signal Type (FM, GSM, W-CDMA, CDMA, Wi-Fi) Closest Channel Number Number of Carriers Signal-to-Noise Ratio (SNR) > 10 dB
Application Options	Bias-Tee (On/Off), Impedance (50 Ω, 75 Ω, Other)

## Channel Scanner (Option 0027) (Models MS2036/38C only)

Number of Channels	1 to 20 Channels (Power Levels)
Measurements	Graph/Table, Max Hold (On/5 sec/Off), Frequency/Channel, Current/Maximum, Dual Color
Scanner	Scan Channels, Scan Frequencies, Scan Customer List, Scan Script Master™
Amplitude	Reference Level, Scale
Custom Scan	Signal Standard, Channel, # of Channels, Channel Step Size, Custom Scan
Frequency Range	150 kHz to 13 GHz
Frequency Accuracy	± 10 Hz + Time base error
Measurement Range	-110 dBm to +30 dBm
Application Options	Bias-Tee (On/Off), Impedance (50 Ω, 75 Ω, Other)



## GPS (Option 0031), (Models MS2036/38C only) Requires external GPS antenna

Built-in GPS provides location information (latitude, longitude, altitude) and Universal Time (UT) information for storage along with trace data so you can later verify that measurements were taken at the right location. The GPS option requires a separately ordered magnet mount GPS antenna (2000-1528-R), which is configured with a 15 foot (~5 m) cable to mount outside on a metallic surface. Frequency accuracy is enhanced for the Spectrum Analyzer when Options 0025 Interference Analyzer and 0027 Channel Scanner are engaged.

Setup	On/Off, Antenna Voltage 3.3/5.0 V, GPS Info
GPS Time/Location Indicator	Time, Latitude, Longitude and Altitude on display Time, Latitude, Longitude and Altitude with trace storage
High Frequency Accuracy	Spectrum Analyzer, Interference Analyzer, CW Signal Generator when GPS Antenna is connected < ± 50 ppb with GPS On, 3 minutes after satellite lock in selected mode
GPS Lock – after antenna is disconnected	< ± 50 ppb for 3 days, 0 °C to 50 °C ambient temperature
Connector	SMA, female

## Balanced/Differential S-Parameters, 1-port (Option 0077)

As an alternative to a sampling oscilloscope, verifying the performance and identifying discontinuities in high-data-rate differential cables is now possible with the VNA Master. After a full two-port calibration, connect your differential cable directly to the two test ports and reveal the  $S_{didi}$  performance, which is essentially differential return loss, or any of the other differential S-Parameters,  $S_{cici}$ ,  $S_{dici}$ , or  $S_{cidi}$ . With optional time domain, you can convert frequency sweeps to distance. This capability is especially valuable for applications in high data rate cables where balanced data formats are used to isolate noise and interference.

## Distance Domain (Option 0501) (included in Time Domain Option 0002)

Distance Domain Analysis is a powerful field test tool to analyze cables for faults, including minor discontinuities that may occur due to a loose connection, corrosion, or other aging effects. By using Frequency Domain Reflectometry (FDR), the VNA Master exploits a user-specified band of full power operational frequencies (instead of DC pulses from TDR approaches) to more precisely identify cable discontinuities. The VNA Master converts S-parameters from frequency domain into distance domain on the horizontal display axis, using a mathematical computation called Inverse Fourier Transform. Connect a reflection at the opposite end of the cable and the discontinuities appear versus distance to reveal any potential maintenance issues. When access to both ends of the cable is convenient, a similar distance domain analysis is available on transmission measurements.

Option 0501 Distance Domain will improve your productivity with displays of the cable in terms of discontinuities versus distance. This readout can then be compared against previous measurements (from stored data) to determine whether any degradations have occurred since installation (or the last maintenance activity). More importantly, you will know precisely where to go to fix the problem and so minimize or prevent downtime of the system.

# VNA Master General Specifications (MS202x/3xC)

## Setup Parameters

<b>System</b>	Status (Temperature, Battery Info, S/N, Firmware Ver, IP Address, Options Installed) Self Test, Application Self Test GPS (see Option 0031)
<b>System Options</b>	Name, Date and Time, Ethernet Configuration, Brightness, Volume Language (English, French, German, Spanish, Chinese, Japanese, Korean, Italian, User defined) Reset (Factory Defaults, Master Reset, Update Firmware)
<b>File</b>	Save, Recall, Delete, Directory Management
<b>Save/Recall</b>	Setups, Measurements, Screen Shots Jpeg (save only)
<b>Delete</b>	Selected File, All Measurements, All Mode Files, All Content
<b>Directory Management</b>	Sort Method (Name/Type/Date), Ascend/Descend, Internal/USB, Copy
<b>Internal Trace/Setup Memory</b>	> 13,000 traces
<b>External Trace/Setup Memory</b>	Limited by size of USB Flash drive
<b>Mode Switching</b>	Auto-Stores/Recalls most recently used Setup Parameters in the Mode

## Connectors

<b>Maximum Input (Damage Level) into Vector Network Analyzer</b>	+23 dBm, ±50 VDC (MS202x/3xC)
<b>Maximum Input (Damage Level) into Spectrum Analyzer</b>	+30 dBm, ±50 VDC (MS203xC)
<b>VNA Connectors</b>	Type N female (or K female with opt 0011, MS20x8C only) VNA port (x2) Type BNC female Bias Tee port (enabled with opt 0010) (x2) Type BNC female External Reference In port
<b>Spectrum Analyzer Connectors</b>	Type N, female (or K female with opt 0011) (MS203xC)
<b>GPS</b>	SMA female (Available with opt 0031 GPS)
<b>External Power</b>	5.5 mm barrel connector, 12 to 15 VDC, < 5.0 Amps
<b>LAN Connection</b>	RJ48C, 10/100 Mbps, Connect to PC or LAN for Remote Access (Available with opt 0411 Ethernet)
<b>USB Interface (2)</b>	Type A, Connect Flash Drive and Power Sensor
<b>USB Interface</b>	5-pin mini-B, Connect to PC for data transfer
<b>Headset Jack</b>	2.5 mm barrel connector
<b>External Trigger</b>	BNC, female, 50 Ω, Maximum Input ± 5 VDC
<b>10 MHz Out</b>	SMA, female, 50 Ω

## Display

<b>Size</b>	8.4 in, daylight viewable color LCD
<b>Resolution</b>	800 x 600

## Power

<b>Field replaceable Li-Ion Battery (633-44: 6600 mAh, 4.5 Amps)</b>	40 Watts on battery power only
<b>DC power from Universal 110/220V AC/DC Adapter</b>	55 Watts running off AC/DC adaptor while charging battery
<b>Life time charging cycles (Li-Ion Battery, 633-44)</b>	>300 (80% of initial capacity)
<b>Battery Operation</b>	2.5 hours, typical

## Size and Weight

<b>Dimensions</b>	Height	211 mm (8.3 in)
	Width	315 mm (12.4 in)
	Depth	78 mm (3.1 in) (MS202xC) 97 mm (3.8 in) (MS203xC)
<b>Weight, Including Battery</b>	4.5 kg (9.9 lbs) (MS202xC)	
	4.8 kg (10.5 lbs) (MS203xC)	

## Safety

<b>Safety Class</b>	EN 61010-1 Class 1
<b>Product Safety</b>	IEC 60950-1 when used with Anritsu supplied Power Supply

## Environmental

MIL-PRF-28800F, Class 2 Environmental Conditions	MS202x/3xC
Temperature, operating (°C) (3.8.2.1 & 4.5.5.14)	Passed, -10 °C to 55 °C, Humidity 85%
Temperature, not operating (°C) (3.8.2.2 & 4.5.5.1)	Passed, -51 °C to 71 °C
Relative humidity (3.8.2.3 & 4.5.5.1)	Passed
Altitude, not operating (3.8.3 & 4.5.5.2)	Passed*, 4600 m
Altitude, operating (3.8.3 & 4.5.5.2)	Passed*, 4600 m
Vibration limits (3.8.4.1 & 4.5.5.3.1)	Passed
Shock, functional (3.8.5.1 & 4.5.5.4.1)	Passed
Transit Drop (3.8.5.2 & 4.5.5.4.2)	Passed
Bench handling (3.8.5.3 & 4.5.5.4.3)	Passed
Shock, high impact (3.8.5.4 & 4.5.5.4.4)	Not Required**
Salt exposure structural parts (3.8.8.2 & 4.5.6.2.2)	Not Required***

\* Qualified by similarity (tested on a similar product)

\*\* Not defined in standard; must be invoked and defined by purchase description

\*\*\* Not required for Class 2 equipment

## Electromagnetic Compatibility

<b>European Union</b>	CE Mark, EMC Directive 89/336/EEC, 92/31/EEC, 93/68/EEC and Low Voltage Directive 73/23/EEC, 93/68/EEC
<b>Australia and New Zealand</b>	C-tick N274
<b>Interference</b>	EN 61326-1
<b>Emissions</b>	EN 55011
<b>Immunity</b>	EN 61000-4-2/-4-3/-4-4/-4-5/-4-6/-4-11

## Ancillary Module extends Optical Fiber Testing to Distance-to-Fault

The ODTF-1 module is primarily intended for field use by technicians and engineers responsible for the deployment and maintenance of remote radio heads (RRH), and nicely complements the field diagnostic power of the VNA Master. The ODTF-1 module is fully compatible with the MS202x/3xC VNA Masters which are equipped with the Time Domain Option 0002 or Distance Domain Option 0501. Field operation of the ODTF-1 module with the VNA Master requires the normal DTF (RF/microwave) mode along with simple modification of some of the setup parameters such as  $V_p$ , cable loss, and frequency.

VNA Master users need only to connect a short cable between the RF output of the VNA and the ODTF-1 module and perform a 1-port calibration at the end of the cable. Essentially the ODTF-1 module is simply a wavelength translator, RF test signals in, RF signals returning. The same physics that apply to the traditional DTF measurements apply to ODTF-1 meaning highly accurate measurements can be made with event resolution as good as 10 cm. The same trade-offs carry over as well so better event resolution translates to shorter maximum distance, and vice-versa. Max distance is specified at 1020 meters (3345 ft).

The battery life of the ODTF-1 module matches the battery life of the VNA Master. It can be charged with the same 40-168-R power supply so there is no need to maintain different power supplies.



Using a VNA Master equipped with Option 0002 or 0501, this ODTF-1 optical module translates the optical signals to the RF domain of the VNA, to display fault locations in standard optical fibers.

### Specifications

Wavelength	1550 nm typical
Frequency Range	1 GHz to GHz
Fiber Type	Single Mode Fiber (SMF)
Event Resolution	10.2 cm (0.335 ft) maximum, or $150/(n \cdot \Delta F)$ , $\Delta F$ in MHz, n is IOR
Horizontal Range	1020 meter (3345 ft) maximum, or $(\#dp-1) \cdot \text{Event Resolution}$
Optical Dynamic Range	30 dB
Optical Output Power	3 dBm typical

### Input and Output Ports

RF Connector	N(m)
Max RF Input Power	+ 5 dBm
Optical Connector	FC/APC

### General Specifications

External DC Input	+12.5 to +15 VDC, 3A maximum
Electromagnetic Compatibility	Meets European Community requirements for CE marking
Temperature Operating	0 to 50 °C
Non-operating	0 to 70 °C recommended

### Size and Weight

Size	15.7*5.37*18.6 cm (6.18*2.11*7.3 in.)
Weight	< 1 kg (2.2 lbs)

## Master Software Tools and Remote Programming

Each VNA Master ships with a versatile test assistant: a copy of Anritsu's Master Software Tools for Windows® 2000/XP/Vista/7. This allows an operator to add the processing capabilities of a PC and this software utility to the VNA Master to form a powerful and flexible measurement solution for network analysis. For automation, the VNA Master also supports remote programming via the Ethernet or USB interface.

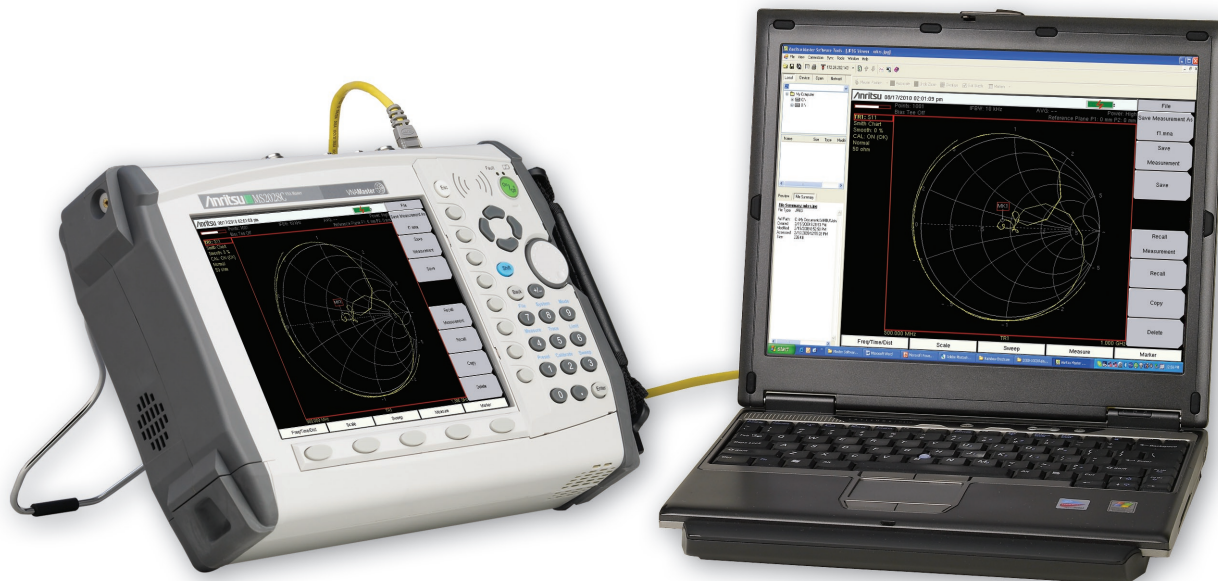

*Connect VNA Master to a PC for archiving and additional post-processing.  
A standard tilt-bail provides convenient use on a bench.*

Feature	Benefit
Powerful data management tool for storing and sifting through measurement results	MST simplifies transfers, printing, and archival of displays and setups
Connect to a PC using USB2.0 (full-speed), Ethernet LAN, or Direct Ethernet	Unleash powerful MST capabilities by using variety of popular remote interfaces
Store an unlimited number of setups, traces, and JPEGs (limited only by PC memory)	Develop libraries of frequently used setups and typical results
Manipulate traces and further optimize displays	Versatility to further analyze results without re-taking measurements
Update with the latest firmware	Easily download and upgrade to newest features from <a href="http://www.us.anritsu.com">www.us.anritsu.com</a>
Remote programming via Ethernet or USB	Increase throughput by automating repetitive or operator intensive tasks

## Ordering Information

<b>MS2026C<sup>1</sup></b>	<b>MS2028C<sup>1</sup></b>	<b>MS2036C<sup>1</sup></b>	<b>MS2038C<sup>1</sup></b>	
VNA Master, 2-port, VNA 5 kHz to 6 GHz	VNA Master, 2-port, VNA 5 kHz to 20 GHz	VNA Master + Spectrum Analyzer, S/A 9 kHz to 9 GHz	VNA Master + Spectrum Analyzer, S/A 9 kHz to 20 GHz	
<b>Options</b>				<b>Description</b>
MS2026C-0002	MS2028C-0002	MS2036C-0002	MS2038C-0002	Time Domain (includes DTF capability)
MS2026C-0005	MS2028C-0005	–	–	Power Monitor (requires external detector)
MS2026C-0007	MS2028C-0007	MS2036C-0007	MS2038C-0007	Secure Data Operation
MS2026C-0010	MS2028C-0010	MS2036C-0010	MS2038C-0010	Built-in Bias-Tee
–	MS2028C-0011	–	MS2028C-0011	K(f) Test Port Connectors
MS2026C-0015	MS2028C-0015	MS2046C-0015	MS2038C-0015	Vector Voltmeter
MS2026C-0019	MS2028C-0019	MS2036C-0019	MS2038C-0019	High Accuracy Power Meter (requires external USB sensor)
–	–	MS2036C-0025	MS2038C-0025	Interference Analysis, 9 kHz to 9/20 GHz <sup>2</sup>
–	–	MS2036C-0027	MS2038C-0027	Channel Scanner, 9 kHz to 9/20 GHz <sup>2</sup>
MS2026C-0031	MS2028C-0031	MS2036C-0031	MS2038C-0031	GPS Receiver (requires GPS antenna, 2000-1528-R)
MS2026C-0077	MS2028C-0077	MS2036C-0077	MS2038C-0077	Balanced/Differential S-Parameters, 1-port
MS2026C-0098	MS2028C-0098	MS2036C-0098	MS2038C-0098	Z-540 Calibration
MS2026C-0099	MS2028C-0099	MS2036C-0099	MS2038C-0099	Premium Calibration
MS2026C-0501	MS2028C-0501	MS2036C-0501	MS2038C-0501	Distance Domain (included in Option 0002)

**Notes:**

1) Includes standard one-year warranty and Certificate of Calibration and Conformance.

2) Requires external antenna (2000-xxxx or 61532 Antenna Kit), Recommend Option 0031 GPS

### MS202x/3xC Standard Accessories

10580-00220	VNA Master User's Guide
65729	Soft Carrying Case
2300-498	Master Software Tools CD ROM
633-44	Rechargeable Battery, Li-Ion, 6.6 Ah
40-168-R	AC-DC Adapter
806-141-R	Automotive Cigarette Lighter 12 V DC adapter
3-2000-1498	USB A-type to Mini USB B-type cable, 3.05 m (10 ft.)
2000-1371-R	Ethernet cable, 2.13 m (7 ft.)
3-806-152	Ethernet Crossover Cable, 2.13 m (7 ft.)
2000-1520-R	USB Flash Drive

### Ancillary Equipment

ODTF-1	Optical Time Domain Module
15NNF50-1.5C	Armored Test Port Cable, 1.5 meter, N(m) to N(f)
OSLN50-1	Precision Open/Short/Load, DC to 6 GHz, 42 dB Return Loss



## Ordering Information (continued)

### Optional Accessories

#### High Accuracy Power Sensor

PSN50	High Accuracy Power Sensor, 50 MHz to 6 GHz
MA24104A	Inline High Power Sensor, 600 MHz to 4 GHz, True RMS
MA24106A	High Accuracy Power Sensor, 50 MHz to 6 GHz, True RMS
MA24108A	High Accuracy Power Sensor, 10 MHz to 8 GHz, True RMS
MA24118A	High Accuracy Power Sensor, 10 MHz to 18 GHz, True RMS
MA24126A	High Accuracy Power Sensor, 10 MHz to 26 GHz, True RMS

#### Power Monitor Detectors

560-7N50B	RF Detector, 0.01 to 20 GHz, Type-N(m)
560-7S50B	RF Detector, 0.01 to 20 GHz, W-SMA(m)

#### Detector Extender Cables

800-109	Detector Extender Cable, 7.6m (25 ft)
800-111	Detector Extender Cable, 30.5m (100 ft.)

#### K Connector Components

OSLK50	Precision integrated Open/Short/Load K(m), DC to 20 GHz, 50 Ω
OSLKF50	Precision integrated Open/Short/Load K(f), DC to 20 GHz, 50 Ω
22K50	Precision K(m) Short/Open, 40 GHz
22KF50	Precision K(f) Short/Open, 40 GHz
28K50	Precision Termination, DC to 40 GHz, 50 Ω, K(m)
28KF50	Precision Termination, DC to 40 GHz, 50 Ω, K(f)
3652A	K Calibration Kit, DC to 40 GHz

#### N-Type Connectors

OSLN50	Precision Integrated Open/Short/Load N(m), DC to 18 GHz, 50 Ω
OSLNF50	Precision Integrated Open/Short/Load N(f), DC to 18 GHz, 50 Ω
22N50	Precision N(m) Short/Open, 18 GHz
22NF50	Precision N(f) Short/Open, 18 GHz
28N50-2	Precision Termination, DC to 18 GHz, 50 Ω, N(m)
28NF50-2	Precision Termination, DC to 18 GHz, 50 Ω, N(f)
OSLN50-1	Precision N(m) Open/Short/Load, 42 dB, 6 GHz
OSLNF50-1	Precision N(f) Open/Short/Load, 42 dB, 6 GHz
SM/PL-1	Precision N(m) Load, 42 dB, 6 GHz
SM/PLNF-1	Precision N(f) Load, 42 dB, 6 GHz

#### TNC Connector Components

1091-53-R	Precision TNC(m) Open, 18 GHz, 50 Ω
1091-54-R	Precision TNC(m) Short, 18 GHz, 50 Ω
1015-55-R	Precision TNC(m) Load, 18 GHz, 50 Ω
1091-55-R	Precision TNC(f) Open, 18 GHz, 50 Ω
1091-56-R	Precision TNC(f) Short, 18 GHz, 50 Ω
1015-54-R	Precision TNC(f) Load, 18 GHz, 50 Ω

#### 7/16 Connector Components

2000-1618-R	Precision Open/Short/Load, 7/16(m), 6.0 GHz
2000-1619-R	Precision Open/Short/Load, 7/16(f), 6.0 GHz

#### Directional Antennas

2000-1411-R	824 MHz to 896 MHz, N(f), 10 dBd, Yagi
2000-1412-R	885 MHz to 975 MHz, N(f), 10 dBd, Yagi
2000-1413-R	1710 MHz to 1880 MHz, N(f), 10 dBd, Yagi
2000-1414-R	1850 MHz to 1990 MHz, N(f), 9.3 dBd, Yagi
2000-1415-R	2400 MHz to 2500 MHz, N(f), 10 dBd, Yagi
2000-1416-R	1920 MHz to 2170 MHz, N(f), 10 dBd, Yagi
2000-1519-R	500 MHz to 3000 MHz, log periodic
2000-1617	600 MHz to 21000 MHz, N(f), 5-8 dBi to 12 GHz, 0-6 dBi to 21 GHz, log periodic

#### Portable Antennas

2000-1200	806 MHz to 866 MHz, SMA(m), 50 Ω
2000-1473	870 MHz to 960 MHz, SMA(m), 50 Ω
2000-1035	896 MHz to 941 MHz, SMA (m), 50 Ω (1/4 wave)
2000-1030	1710 MHz to 1880 MHz, SMA(m), 50 Ω (1/2 wave)
2000-1474	1710 MHz to 1880 MHz with knuckle elbow (1/2 wave)
2000-1031	1850 MHz to 1990 MHz, SMA(m), 50 Ω (1/2 wave)
2000-1475	1920 MHz to 1980 MHz and 2110-2170 MHz, SMA(m), 50 Ω
2000-1032	2400 MHz to 2500 MHz, SMA(m), 50 Ω (1/2 wave)
2000-1361	2400 MHz to 2500, 5000 to 6000 MHz, SMA(m), 50 Ω
2000-1616	20 MHz to 21000 MHz, N(f), 50 Ω
61532	Antenna Kit (Consists of: 2000-1030, 2000-1031, 2000-1032-R, 2000-1200, 2000-1035, 2000-1361, and carrying pouch)

#### Bandpass Filters

1030-114-R	806 MHz to 869 MHz, N(m) to SMA(f), 50 Ω
1030-109-R	824 MHz to 849 MHz, N(m) to SMA (f), 50 Ω
1030-110-R	880 MHz to 915 MHz, N(m) to SMA (f), 50 Ω
1030-105-R	890 MHz to 915 MHz Band, 0.41 dB loss, N(m) to SMA(f), 50 Ω
1030-111-R	1850 MHz to 1910 MHz, N(m) to SMA (f), 50 Ω
1030-106-R	1710 MHz to 1790 MHz Band, 0.34 dB loss, N(m) to SMA(f), 50 Ω
1030-107-R	1910 MHz to 1990 MHz Band, 0.41 dB loss, N(m) to SMA(f), 50 Ω
1030-112-R	2400 MHz to 2484 MHz, N(m) to SMA (f), 50 Ω
1030-155-R	2500 MHz to 2700 MHz, N(m) to N(f), 50 Ω

#### Attenuators

3-1010-122	20 dB, 5 W, DC to 12.4 GHz, N(m) to N(f)
42N50-20	20 dB, 5 W, DC to 18 GHz, N(m) to N(f)
42N50A-30	30 dB, 5 W, DC to 18 GHz, N(m) to N(f)
3-1010-123	30 dB, 50 W, DC to 8.5 GHz, N(m) to N(f)
1010-127-R	30 dB, 150 W, DC to 3 GHz, N(m) to N(f)
3-1010-124	40 dB, 100 W, DC to 8.5 GHz, N(m) to N(f), Uni-directional
1010-121	40 dB, 100 W, DC to 18 GHz, N(m) to N(f), Uni-directional
1010-128-R	40 dB, 150 W, DC to 3 GHz, N(m) to N(f)

#### Technical Data Sheet

10580-00548	VNA Master + Spectrum Analyzer Brochure
-------------	---

## Ordering Information (continued)

### Manuals

10580-00305	VNA Master User's Guide
10580-00306	VNA Master Programming Manual
10580-00289	VNA Measurement Guide
10580-00244	Spectrum Analyzer Measurement Guide
10580-00240	Power Meter Measurement Guide
10580-00215	ODTF-1 Optical Distance-to-Fault Module – Quick Start Guide

### Related Literature, Application Notes

11410-00206	Time Domain for Vector Network Analyzers
11410-00214	Reflectometer Measurements – Revisited
11410-00270	What is Your Measurement Accuracy?
11410-00373	Distance-to-Fault
11410-00387	Primer on Vector Network Analysis
11410-00414	High Accuracy Power Meter, PSN50
11410-00424	USB Power Sensor MA24106A
11410-00483	Inline High Power Sensor MA24104A
11410-00504	Microwave USB Power Sensor MA241x8A
11410-00531	Practical Tips on Making “Vector Voltmeter (VVM)” Phase Measurements using VNA Master (Opt. 15)
11410-00472	Measuring Interference

## Waveguide Calibration Components and WG/Coaxial Adapters

Recommended waveguide calibration procedure requires two offset shorts and a precise load. The waveguide/coax adapter, shown attached to test port #2, adapts the VNA Master test ports to the waveguide under test.

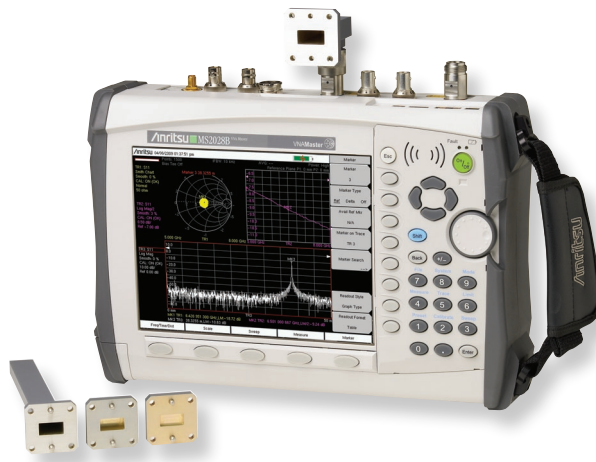

Part Number				Frequency Range	Waveguide Type	Compatible Flanges
1/8 Offset Short	3/8 Offset Short	Precision Load	Coaxial to Universal Waveguide Adapter <sup>[1]</sup>			
23UM70	24UM70	26UM70	35UM70N	5.85 to 8.20 GHz	WR137, WG14	CAR70, PAR70, UAR 70, PDR70
23UM84	24UM84	26UM84	35UM84N	7.05 to 10.00 GHz	WR112, WG15	CBR84, UBR84, PBR84, PDR84
23UM100	24UM100	26UM100	35UM100N	8.20 to 12.40 GHz	WR90, WG16	CBR100, UBR100, PBR100, PDR100
23UM120	24UM120	26UM120	35UM120N	10.00 to 15.00 GHz	WR75, WG17	CBR120, UBR120, PBR120, PDR120
23UA187	24UA187	26UA187	35UA187N	3.95 to 5.85 GHz	WR187, WG12	CPR187F, CPR187G, UG-1352/U, UG-1353/U, UG-1728/U, UG-1729/U, UG-148/U, UG-149A/U
23UA137	24UA137	26UA137	35UA137N	5.85 to 8.20 GHz	WR137, WG14	CPR137F, CPR137G, UG-1356/U, UG-1357/U, UG-1732/U, UG-1733/U, UG-343B/U, UG-344/U, UG-440B/U, UG-441/U
23UA112	24UA112	26UA112	35UA112N	7.05 to 10.00 GHz	WR112, WG15	CPR112F, CPR112G, UG-1358/U, UG-1359/U, UG-1734/U, UG-1735/U, UG-52B/U, UG-51/U, UG-137B/U, UG-138/U
23UA90	24UA90	26UA90	35UA90N	8.20 to 12.40 GHz	WR90, WG16	CPR90F, CPR90G, UG-1360/U, UG-1361/U, UG-1736/U, UG-1737/U, UG-40B/U, UG-39/U, UG-135/U, UG-136B/U
23UA62	24UA62	26UA62	35UA62N	12.40 to 18.00 GHz	WR62, WG18	UG-541A/U, UG-419/U, UG-1665/U, UG1666/U
23UA42	24UA42	26UA42	35UA42K	17.00 to 26.50 GHz	WR42, WG20	UG-596A/U, UG-595/U, UG-597/U, UG-598A/U

[1] For Coaxial/Waveguide Adapter part numbers, N designates Type N and K designates K-Connector





# Anritsu

## Anritsu Corporation

5-1-1 Onna, Atsugi-shi, Kanagawa, 243-8555 Japan  
Phone: +81-46-223-1111  
Fax: +81-46-296-1238

### • U.S.A.

#### Anritsu Company

1155 East Collins Boulevard, Suite 100,  
Richardson, TX, 75081 U.S.A.  
Toll Free: 1-800-ANRITSU (267-4878)  
Phone: +1-972-644-1777  
Fax: +1-972-671-1877

### • Canada

#### Anritsu Electronics Ltd.

700 Silver Seven Road, Suite 120, Kanata,  
Ontario K2V 1C3, Canada  
Phone: +1-613-591-2003  
Fax: +1-613-591-1006

### • Brazil

#### Anritsu Eletrônica Ltda.

Praça Amadeu Amaral, 27 - 1 Andar  
01327-010 - Bela Vista - São Paulo - SP - Brasil  
Phone: +55-11-3283-2511  
Fax: +55-11-3288-6940

### • Mexico

#### Anritsu Company, S.A. de C.V.

Av. Ejército Nacional No. 579 Piso 9, Col. Granada  
11520 México, D.F., México  
Phone: +52-55-1101-2370  
Fax: +52-55-5254-3147

### • U.K.

#### Anritsu EMEA Ltd.

200 Capability Green, Luton, Bedfordshire LU1 3LU, U.K.  
Phone: +44-1582-433280  
Fax: +44-1582-731303

### • France

#### Anritsu S.A.

12 Avenue du Québec,  
Bâtiment Iris 1-Silic 638,  
91140 VILLEBON SUR YVETTE, France  
Phone: +33-1-60-92-15-50  
Fax: +33-1-64-46-10-65

### • Germany

#### Anritsu GmbH

Nemetschek Haus, Konrad-Zuse-Platz 1  
81829 München, Germany  
Phone: +49 (0) 89 442308-0  
Fax: +49 (0) 89 442308-55

### • Italy

#### Anritsu S.p.A.

Via Elio Vittorini, 129, 00144 Roma, Italy  
Phone: +39-06-509-9711  
Fax: +39-06-502-2425

### • Sweden

#### Anritsu AB

Borgafjordsgatan 13, 164 40 KISTA, Sweden  
Phone: +46-8-534-707-00  
Fax: +46-8-534-707-30

### • Finland

#### Anritsu AB

Teknobulevardi 3-5, FI-01530 VANTAA, Finland  
Phone: +358-20-741-8100  
Fax: +358-20-741-8111

### • Denmark

#### Anritsu A/S (for Service Assurance)

#### Anritsu AB (for Test & Measurement)

Kirkebjerg Allé 90 DK-2605 Brøndby, Denmark  
Phone: +45-7211-2200  
Fax: +45-7211-2210

### • Russia

#### Anritsu EMEA Ltd.

#### Representation Office in Russia

Tverskaya str. 16/2, bld. 1, 7th floor.  
Russia, 125009, Moscow  
Phone: +7-495-363-1694  
Fax: +7-495-935-8962

### • United Arab Emirates

#### Anritsu EMEA Ltd.

#### Dubai Liaison Office

P O Box 500413 - Dubai Internet City  
Al Thuraya Building, Tower 1, Suite 701, 7th Floor  
Dubai, United Arab Emirates  
Phone: +971-4-3670352  
Fax: +971-4-3688460

### • Singapore

#### Anritsu Pte. Ltd.

60 Alexandra Terrace, #02-08, The Comtech (Lobby A)  
Singapore 118502  
Phone: +65-6282-2400  
Fax: +65-6282-2533

### • India

#### Anritsu Pte. Ltd.

#### India Branch Office

3rd Floor, Shri Lakshminarayan Niwas, #2726, 80 ft Road,  
HAL 3rd Stage, Bangalore - 560 075, India  
Phone: +91-80-4058-1300  
Fax: +91-80-4058-1301

### • P. R. China (Hong Kong)

#### Anritsu Company Ltd.

Units 4 & 5, 28th Floor, Greenfield Tower, Concordia Plaza,  
No. 1 Science Museum Road, Tsim Sha Tsui East,  
Kowloon, Hong Kong, P.R. China  
Phone: +852-2301-4980  
Fax: +852-2301-3545

### • P. R. China (Beijing)

#### Anritsu Company Ltd.

#### Beijing Representative Office

Room 2008, Beijing Fortune Building,  
No. 5, Dong-San-Huan Bei Road,  
Chao-Yang District, Beijing 100004, P.R. China  
Phone: +86-10-6590-9230  
Fax: +86-10-6590-9235

### • Korea

#### Anritsu Corporation, Ltd.

8F Hyunjuk Bldg, 832-41, Yeoksam-Dong,  
Kangnam-ku, Seoul, 135-080, Korea  
Phone: +82-2-553-6603  
Fax: +82-2-553-6604

### • Australia

#### Anritsu Pty Ltd.

Unit 21/270 Ferntree Gully Road, Notting Hill  
Victoria, 3168, Australia  
Phone: +61-3-9558-8177  
Fax: +61-3-9558-8255

### • Taiwan

#### Anritsu Company Inc.

7F, No. 316, Sec. 1, Neihu Rd., Taipei 114, Taiwan  
Phone: +886-2-8751-1816  
Fax: +886-2-8751-1817



©Anritsu All trademarks are registered trademarks of their respective companies. Data subject to change without notice. For the most recent specifications visit: [www.anritsu.com](http://www.anritsu.com)

11410-00548, Rev. B Printed in United States 2010-09  
©2010 Anritsu Company. All Rights Reserved

## Free Manuals Download Website

<http://myh66.com>

<http://usermanuals.us>

<http://www.somanuals.com>

<http://www.4manuals.cc>

<http://www.manual-lib.com>

<http://www.404manual.com>

<http://www.luxmanual.com>

<http://aubethermostatmanual.com>

Golf course search by state

<http://golfingnear.com>

Email search by domain

<http://emailbydomain.com>

Auto manuals search

<http://auto.somanuals.com>

TV manuals search

<http://tv.somanuals.com>