



GAS-FIRED COPPER BOILERS FOR  
HYDRONIC HEATING AND HOT WATER SUPPLY

- Installation
- Operation
- Maintenance
- Limited Warranty



## INSTRUCTION MANUAL

### MODELS:

### VB/VW-500, 750 AND 1000

### SERIES 200/201

**WARNING:** If the information in this manual is not followed exactly, a fire or explosion may result causing property damage, personal injury or loss of life.

- Do not store or use gasoline or other flammable vapors and liquids in the vicinity of this or any other appliance.
- **WHAT TO DO IF YOU SMELL GAS:**
  - Do not try to light any appliance.
  - Do not touch any electrical switch; do not use any phone in your building.
  - Immediately call your gas supplier from a neighbor's phone. Follow the gas supplier's instructions.
  - If you cannot reach your gas supplier, call the fire department.
- Installation and service must be performed by a qualified installer, service agency or the gas supplier.



### **⚠ WARNING**

Read and understand this manual and all Warnings and Cautions within before installing and using this appliance.

Place these instructions adjacent to boiler and notify owner to keep for future reference.







MC BEE, SC., RENTON, WA.,  
STRATFORD-ONTARIO, VELDHOVEN-THE NETHERLANDS,  
NANJING, CHINA  
[www.hotwater.com](http://www.hotwater.com) / email: [parts@hotwater.com](mailto:parts@hotwater.com)

# SAFE INSTALLATION, USE AND SERVICE

The proper installation, use and servicing of this boiler is extremely important to your safety and the safety of others.

Many safety-related messages and instructions have been provided in this manual and on your boiler to warn you and others of a potential injury hazard. Read and obey all safety messages and instructions throughout this manual. It is very important that the meaning of each safety message is understood by you and others who install, use, or service this boiler.

	This is the safety alert symbol. It is used to alert you to potential personal injury hazards. Obey all safety messages that follow this symbol to avoid possible injury or death.
---	--

	DANGER indicates an imminently hazardous situation which, if not avoided, will result in injury or death.
	WARNING indicates a potentially hazardous situation which, if not avoided, could result in injury or death.
	CAUTION indicates a potentially hazardous situation which, if not avoided, could result in minor or moderate injury.
	CAUTION used without the safety alert symbol indicates a potentially hazardous situation which, if not avoided, could result in property damage.

All safety messages will generally tell you about the type of hazard, what can happen if you do not follow the safety message, and how to avoid the risk of injury.

The California Safe Drinking Water and Toxic Enforcement Act requires the Governor of California to publish a list of substances known to the State of California to cause cancer, birth defects, or other reproductive harm, and requires businesses to warn of potential exposure to such substances.

This product contains a chemical known to the State of California to cause cancer, birth defects, or other reproductive harm. This appliance can cause low level exposure to some of the substances listed in the Act.

## IMPORTANT DEFINITIONS

- **Qualified Installer:** A qualified installer must have ability equivalent to a licensed tradesman in the fields of plumbing, air supply, venting and gas supply, including a thorough understanding of the requirements of the National Fuel Gas Code as it relates to the installation of gas fired boilers. The qualified installer must have a thorough understanding of this instruction manual.
- **Service Agency:** A service agency also must have ability equivalent to a licensed tradesman in the fields of plumbing, air supply, venting and gas supply, including a thorough understanding of the requirements of the National Fuel Gas Code as it relates to the installation of gas fired boilers. The service agency must also have a thorough understanding of this instruction manual, and be able to perform repairs strictly in accordance with the service guidelines provided by the manufacturer.
- **Gas Supplier:** The Natural Gas or Propane Utility or service who supplies gas for utilization by the gas burning appliances within this application. The gas supplier typically has responsibility for the inspection and code approval of gas piping up to and including the Natural Gas meter or Propane storage tank of a building. Many gas suppliers also offer service and inspection of appliances within the building.

# GENERAL SAFETY



## ⚠️ WARNING

Read and understand this manual and all Warnings and Cautions within before installing and using this appliance.

Place these instructions adjacent to boiler and notify owner to keep for future reference.

## ⚠️ DANGER

Untempered hot water can cause severe burns instantly resulting in severe injury or death.

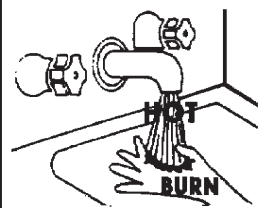

Children, elderly, and the physically or mentally disabled are at highest risk for scald injury.

Feel water before bathing or showering. Temperature limiting valves are available.

Read instruction manual for safe temperature setting.

## ⚠️ DANGER

### Fire or Explosion Hazard

- Do not store or use gasoline or other flammable vapors and liquids in the vicinity of this or any other appliance.
- Avoid all ignition sources if you smell LP gas.
- Do not expose boiler control to excessive gas pressure.
- Use only gas shown on rating plate.
- Maintain required clearances to combustibles.
- Keep ignition sources away from faucets after extended period of non-use.



Read instruction manual before installing, using or servicing.



## ⚠️ WARNING

### Fire Hazard

For continued protection against risk of fire:

- Do not install boiler on carpeted floor.
- Do not operate boiler if flood damaged.

## ⚠️ DANGER

### Fire or Explosion Hazard

- Do not store or use gasoline or other flammable vapors and liquids in the vicinity of this or any other appliance.



## ⚠️ WARNING

### Explosion Hazard

- Overheated water can cause water tank explosion.
- Properly sized temperature and pressure relief valve must be installed.

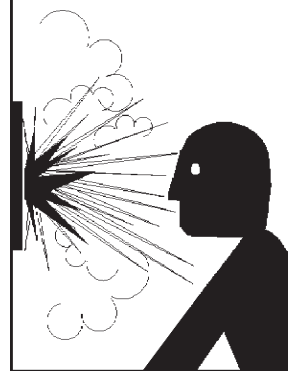

## ⚠️ WARNING

### Breathing Hazard - Carbon Monoxide Gas

- Special consideration must be taken with installations above 7000 feet.
- Please contact an AO Smith qualified service agent to obtain the proper setup and instructions before lighting.
- Failure to implement the proper setup will result in improper and inefficient operation of the appliance resulting in production of increased levels of carbon monoxide gas in excess of the safe limits which could result in serious personal injury or death.



Breathing carbon monoxide can cause brain damage or death. Always read and understand instruction manual.

## CAUTION

### Improper installation and use may result in property damage.

- Do not operate boiler if flood damaged.
- Install in location with drainage.
- Fill boiler with water before operation.
- Be alert for thermal expansion.

Refer to instruction manual for installation and service.

# DIMENSION AND CAPACITY DATA

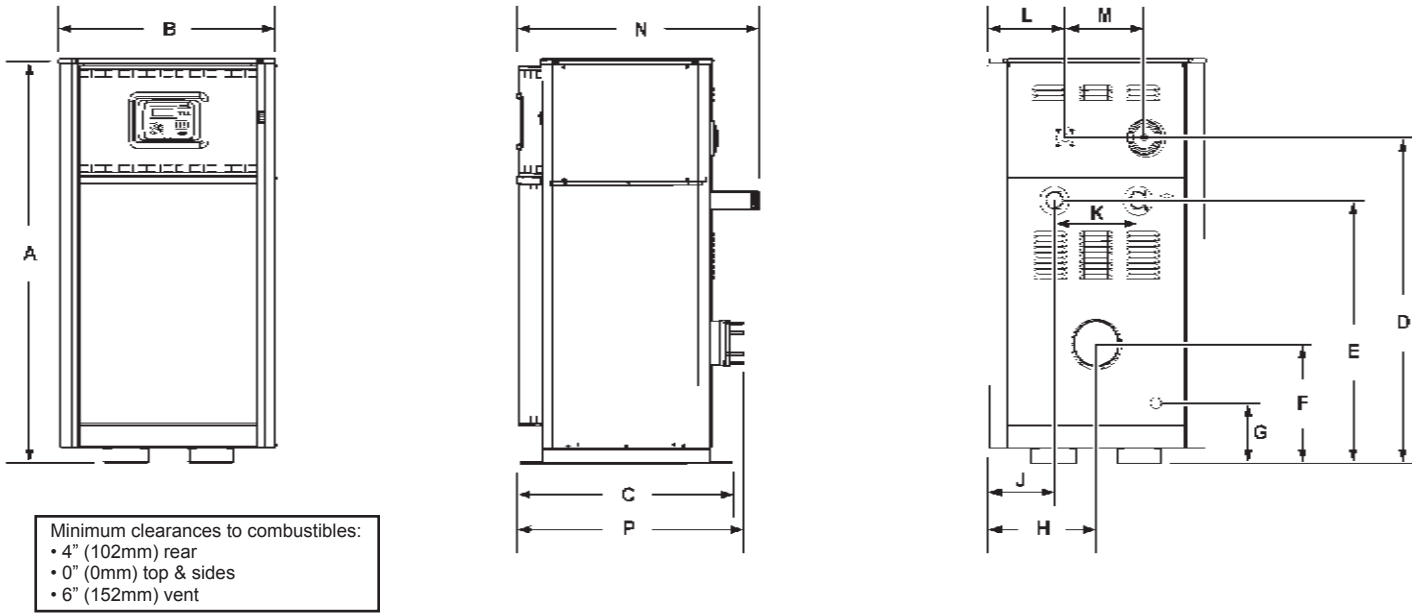

FIGURE 1.

**TABLE 1. - GAS AND ELECTRICAL CHARACTERISTICS**

Model	Manifold Pressure			Maximum Supply Pressure		Minimum Supply Pressure	
	Type of Gas	Inches W.C.	kPa	Inches W.C.	kPa	Inches W.C.	kPa
VB/VW-500, 750, 1000	NATURAL	-2 to -3.5	-5 to 9	14	3.44	4.0	2.0
VB/VW-500, 750, 1000	PROPANE	-2 to -3.5	-5 to 9	14	3.44	8.0	2.0

Minimum Pressures must be maintained during all operating conditions.  
 Electrical Power: 120v, 60hz, and 30 amps.

**TABLE 2. - ROUGH-IN DIMENSIONS**

Models	VB/VW-500		VB/VW-750		VB/VW-1000	
	inches	mm	inches	mm	inches	mm
<b>Flue Outlet Diameter</b>	6	152	6	152	6	152
<b>Air Intake Diameter</b>	4	102	4	102	4	102
<b>Water Inlet</b>	2" NPT					
<b>Water Outlet</b>	2" NPT					
<b>Gas Inlet</b>	1" NPT					
<b>A</b>	56	1422	62	1575	71	1803
<b>B</b>	30	762	30	762	30	762
<b>C</b>	30	762	30	762	30	762
<b>D</b>	45	1143	51	1295	59	1499
<b>E</b>	36	914	42	1067	48	1219
<b>F</b>	16.5	419	16.5	419	16.5	419
<b>G</b>	8	203	8	203	8	203
<b>H</b>	15	381	15	381	15	381
<b>J</b>	9	229	9	229	9	229
<b>K</b>	11.5	292	11.5	292	11.5	292
<b>L</b>	11	279	11	279	11	279
<b>M</b>	10.5	267	10.5	267	10.5	267
<b>N</b>	33	838	33	838	33	838
<b>P</b>	31	787	31	787	31	787

# CAPACITY AND FLOW DATA

**TABLE 3. RECOVERY CAPACITIES.**

Model No.	Input Rating Btu/hr	Output Rating Btu/hr	Water Flow	Temperature Rise - °F (°C)						
				40	60	80	90	100	120	140
				(22)	(33)	(44)	(90)	(56)	(67)	(78)
VW-500	500,000	421,500	GPH	1,268	845	634	563	507	423	362
			LPH	4,797	3,198	2,399	2,132	1,919	1,599	1,371
VW-700	750,000	633,750	GPH	1,901	1,268	951	845	761	634	543
			LPH	7,196	4,797	3,598	3,198	2,878	2,399	2,056
VW-1000	1,000,000	845,000	GPH	2,535	1,690	1,268	1,127	1,014	845	724
			LPH	9,595	6,397	4,797	4,264	3,838	3,198	2,741

**TABLE 4. PUMPING PERFORMANCE GUIDE.**

MODEL	VB MODELS - FLOW, HEAD LOSS AND TEMPERATURE RISE																							
	20F° (11°C) Δt				30F° (17°C) Δt				40F° (22°C) Δt				Maximum Flow Rate				Minimum Flow Rate							
	GPM	LPH	ΔPFT	ΔP <sub>m</sub>	GPM	LPH	ΔPFT	ΔP <sub>m</sub>	GPM	LPH	ΔPFT	ΔP <sub>m</sub>	GPM	LPH	ΔPFT	ΔP <sub>m</sub>	ΔT°F	ΔT°C	GPM	LPH	ΔPFT	ΔP <sub>m</sub>	ΔT°F	ΔT°C
VB-500	42	159	1.8	0.5	28	106	1.3	0.4	21	79	1.0	0.3	100	379	3.8	1.2	8	4	21	79	1.0	0.3	40	22
VB-750	63	238	2.9	0.9	42	159	2.1	0.6	32	121	1.8	0.5	110	416	4.3	1.3	12	7	32	121	1.8	0.5	40	22
VB-1000	85	322	3.9	1.2	56	212	2.8	0.9	42	159	2.3	0.7	120	454	4.9	1.5	14	8	42	159	2.3	0.7	40	22

# CONTENTS

SAFE INSTALLATION, USE AND SERVICE .....	2	Horizontal Installation Requirements.....	17
GENERAL SAFETY.....	3	Direct Vent Installation Requirements .....	19
DIMENSION AND CAPACITY DATA.....	4	INSTALLATION REQUIREMENTS FOR THE COMMONWEALTH OF MASSACHUSETTS.....	19
CAPACITY AND FLOW DATA.....	5	SYSTEM INSTALLATION .....	22
CONTENTS.....	6	General.....	22
INTRODUCTION.....	6	Hot Water Heating (Hydronic) Equipment.....	22
Grounding Instructions.....	7	Internal Contaminants.....	23
Inlet Water Considerations.....	7	Hot Water Supply Boiler System - General Water Line Connections.....	23
Correct Gas.....	7	Hard Water Conditions.....	23
Precautions.....	7	Thermal Expansion (Closed System).....	23
Liquefied Petroleum Gas Models.....	7	Remote Probe Installation Procedure .....	23
High Altitude Installations.....	7	Gas Connections .....	24
Field Installed Components.....	7	Gas Supply Line Sizing.....	24
CONTROL COMPONENTS.....	8	Wiring.....	28
The Control System.....	8	SUGGESTED PIPE SIZING TABLES .....	29
Hot Surface Igniter.....	8	WIRING DIAGRAM .....	30
Pressure Switches.....	8	VB/VW-500, 750 & 1000 SCHEMATIC DIAGRAM.....	32
Low Gas Switch.....	8	OPERATION.....	33
Water Flow Switch.....	8	Important.....	33
Flame Sensor.....	8	General.....	33
Water Temperature Limit Controls.....	9	Filling and Purging of Heating Boiler Installation.....	33
ON/OFF Switch.....	9	Filling Hot Water Supply Boiler Installation .....	33
Circulating Pump.....	9	Purging Gas Line.....	33
Temperature Probes.....	9	Inlet Gas Pressure.....	33
Low Water Cutoff (Optional).....	9	Water Temperature Regulation.....	34
Pressure Relief Valve.....	9	LIGHTING & OPERATION INSTRUCTIONS.....	36
GENERAL.....	10	Adjustment .....	37
Required Ability .....	10	Setting of the Test Mode.....	37
Location.....	10	Control System.....	37
Panels and Covers.....	10	Inputs to MCB.....	38
Chemical Vapor Corrosion.....	11	Operating Sequence.....	39
Installation Clearances.....	11	UIM Operating Procedures.....	40
Leveling.....	11	Operating Setpoint Adjustment Procedure.....	41
Air Requirements.....	11	High Limit Differential Setpoint Adjustment Procedure.....	42
Unconfined Space.....	11	TROUBLESHOOTING IGNITION SYSTEM .....	44
Confined Space.....	11	Troubleshooting Gas Valve.....	45
Fresh Air Openings for Confined Spaces.....	11	Main Burner.....	45
Outdoor Air Through Two Openings.....	12	PREVENTATIVE MAINTENANCE.....	45
Outdoor Air Through One Opening .....	12	Relief Valve.....	46
Outdoor Air Through Two Horizontal Ducts.....	12	Combustion Air Filter.....	46
Outdoor Air Through Two Vertical Ducts.....	12	Blower Compartment.....	46
Air From Other Indoor Spaces.....	13	Burner Maintenance.....	46
Termination Clearances Sidewall Power Vent.....	14	Condensate Removal System.....	46
Termination Clearances Sidewall Direct Vent.....	15	Venting Maintenance .....	47
VENTING.....	16	Heat Exchanger Preventative Maintenance.....	47
Special Installation Considerations.....	16	Delimiting.....	47
Venting System Using AL 29-4C®.....	16	Tube Cleaning Procedure Mechanical Removal of Deposits.....	47
General Exhaust Vent Installation Procedure.....	16	Replacement Parts .....	47
Connecting Vent to Boiler.....	16	NOTES.....	48
Venting Supports.....	17	LIMITED WARRANTY.....	51
Vertical Installation Requirements.....	17		

## INTRODUCTION

This design complies with the current edition of the ANSI Z21.13 low-pressure boiler standard.

Compliance under this standard implies that when the boiler underwent test, the gas manifold and control assembly provided on the boiler met safe lighting and other performance criteria.

Detailed installation diagrams are found in this manual. These diagrams will serve to provide the installer a reference for the materials and methods of piping necessary. It is essential that all water, gas piping and wiring be installed as shown on the diagrams. You should thoroughly read and understand this manual before installation and/or operation of this boiler.

The factory warranty will be void if the boiler(s) have been improperly installed or operated.

AL 29-4C® is a registered trademark of Allegheny Ludlum Corporation.

In addition to these instructions, the boiler(s) shall be installed in accordance with those installation regulations in force in the local area where the installation is to be made. These shall be carefully followed in all cases. Authorities having jurisdiction should be consulted before installations are made.

In the absence of local codes, the installation must comply with the current editions, as follows:

### In the United States:

The National Fuel Gas Code, ANSI Z223.1/NFPA 54 and the National Electric Code, NFPA 70.

## GROUNDING INSTRUCTIONS

This boiler must be grounded in accordance with the National Electrical Code and/or local codes. Boiler is polarity sensitive; correct wiring is imperative for proper operation.

This boiler must be connected to a grounded metal, permanent wiring system, or an equipment grounding conductor must be run with the circuit conductors and connected to the equipment grounding terminal or lead on the boiler.

## INLET WATER CONSIDERATIONS

To minimize the amount of condensate, a minimum inlet water temperature to the heat exchanger of 120°F (49°C) shall be maintained. This temperature can be acquired by returning 120°F (49°C) water from the remote storage tank to the boiler or by installing a by-pass loop between the boiler's inlet and outlet connections. When installing a by-pass loop, a remote probe MUST be used, see SYSTEM INSTALLATION.

Circulating water through the boiler and to the remote storage tank (if applicable) is accomplished by a pump on VW models only. For hot water heating systems using the VB model, the circulating pump is NOT provided on standard models (optional) and must be field installed.

## CORRECT GAS

MAKE SURE THE GAS ON WHICH THE BOILER WILL OPERATE IS THE SAME AS THAT SPECIFIED ON THE BOILER RATING PLATE. DO NOT INSTALL THE BOILER IF EQUIPPED FOR A DIFFERENT TYPE OF GAS — CONSULT YOUR SUPPLIER.

## PRECAUTIONS

**IF THE UNIT IS EXPOSED TO THE FOLLOWING, DO NOT OPERATE UNTIL ALL CORRECTIVE STEPS HAVE BEEN MADE BY A QUALIFIED SERVICE AGENT:**

1. EXPOSURE TO FIRE.
2. IF DAMAGED.
3. FIRING WITHOUT WATER.
4. SOOTING.

**IF THE BOILER HAS BEEN EXPOSED TO FLOODING, IT MUST BE REPLACED.**

## LIQUEFIED PETROLEUM GAS MODELS

Boilers for propane or liquefied petroleum gas (LPG) are different from natural gas models. A natural gas boiler will not function safely on LP gas and no attempt should be made to convert a boiler from natural gas to LP gas.

LP gas must be used with great caution. It is highly explosive and heavier than air. It collects first in the low areas making its odor difficult to detect at nose level. If LP gas is present or even suspected, do not attempt to find the cause yourself. Leave the building, leaving

doors open to ventilate, then call your gas supplier or service agent. Keep area clear until a service call has been made.

At times you may not be able to smell an LP gas leak. One cause is odor fade, which is a loss of the chemical odorant that gives LP gas its distinctive smell. Another cause can be your physical condition, such as having a cold or diminishing sense of smell with age. For these reasons, the use of a propane gas detector is recommended.

**IF YOU EXPERIENCE AN OUT OF GAS SITUATION, DO NOT TRY TO RELIGHT APPLIANCES YOURSELF.** Call your local service agent. Only trained LP professionals should conduct the required safety checks in accordance with industry standards.

## HIGH ALTITUDE INSTALLATIONS

**⚠ WARNING**

**Breathing Hazard - Carbon Monoxide Gas**

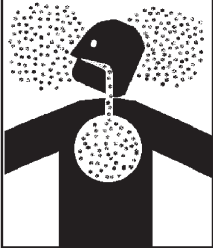

- Special consideration must be taken with installations above 7000 feet.
- Please contact an AO Smith qualified service agent to obtain the proper setup and instructions before lighting.
- Failure to implement the proper setup will result in improper and inefficient operation of the appliance resulting in production of increased levels of carbon monoxide gas in excess of the safe limits which could result in serious personal injury or death.

Breathing carbon monoxide can cause brain damage or death.  
Always read and understand instruction manual.

Rated inputs are suitable up to 7000 feet (2134m) elevation. Consult the factory for installation at altitudes over 7000 feet (2134m).

## FIELD INSTALLED COMPONENTS

When installing the boiler, the following components MUST be installed:

- 1) Circulating Pump (Hydronic)
- 2) Tank Temperature Control Probe (Hot Water Supply)
- 3) Remote Temperature Control Probe (Hydronic)
- 4) Storage Tank T&P Relief Valve
- 5) Manual Gas Shutoff Valve (Supply)

Check the FEATURES AND CONTROLS section for further information.

# CONTROL COMPONENTS

## THE CONTROL SYSTEM

The control system consists of four basic components: 1) Modulation Control Board (MCB); 2) Power Distribution Board (PDB); 3) Variable Frequency Drive (VFD), see Figure 2; User Interface Module, see Figure 20. The Modulation Control Board and the Power Distribution Board are located in the control box and can be accessed by opening the front door of the unit. The User Interface Module is attached to the front door panel. Every system will have one Modulation Control Board (MCB), one Power Distribution Board (PDB), and one User Interface Module (UIM).

The MCB contains dipswitches which are used to configure the boiler for several different control options, see the Control System Section.

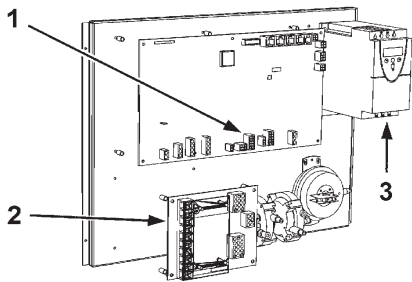

FIGURE 2.

## HOT SURFACE IGNITER

The Hot Surface Igniter is a device that ignites the main burner by high temperature ( $>1800^{\circ}\text{F}$ ) [ $982^{\circ}\text{C}$ ], see Figure 3. The igniter is made of recrystallized silicon carbide, and when 120 VAC is applied to the igniter, sufficient heat is generated to ignite the main burner. Although improvements have been made to strengthen the igniter, it is still fragile and care must be taken in handling the igniter to prevent breakage.

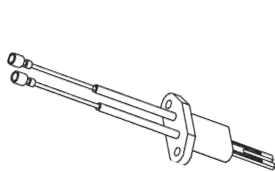

FIGURE 3.

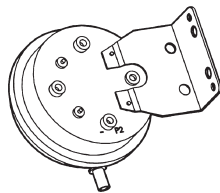

FIGURE 4.

## PRESSURE SWITCHES

This control system has 3 pressure switches that are standard. Blocked Inlet Pressure Switch (BIS), Blower Prover Switch (BPS) Blocked Flue Switch (BFS).

The BPS on this model is a normally open switch that closes on increased vacuum. Once the blower moves enough air to create a vacuum across the Venturi the BPS is activated. If the blower fails or cannot move sufficient air a soft lockout will occur. Inspect the blower for correct operation.

The Blocked Inlet Switch (BIS) will activate is the intake is blocked only during the heating cycle. The BIS is a normally closed pressure switch that opens when the air intake is blocked. If the BIS is activated check and clear the intake of any obstructions.

The blocked flue pressure switch (BFS) activated when the exhaust

flue of the unit is restricted or blocked. The BFS is a normally closed switch that opens when positive pressure is placed on the switch because of any restriction to the exhaust venting. If the BFS is activated check and clear any obstructions causing the restriction.

## LOW GAS SWITCH

This VF boiler is available with a low gas pressure switch which meets the CSD-1 code requirements, see Figure 5.

The Low Gas Pressure Switch (LGPS) is normally closed and remains closed unless the pressure falls below the preset pressure.

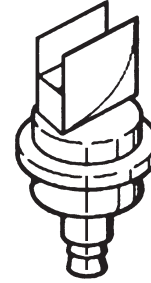

FIGURE 5.  
LOW GAS PRESSURE SWITCH.

## WATER FLOW SWITCH

The water flow switch is installed at the boiler outlet to prevent burner operation in the event of inadequate water flow through the boiler. It is a normally open switch that will close its contacts when increasing water flow rate is detected. The water flow switch is factory-set. The contacts will open when the flow rate drops below the factory setting causing the gas valve to close which will turn off the gas to the burner, see Figure 6. Under no circumstances shall the flow switch be tampered with or bypassed. Doing so may cause damage to the heat exchanger not covered under the warranty.

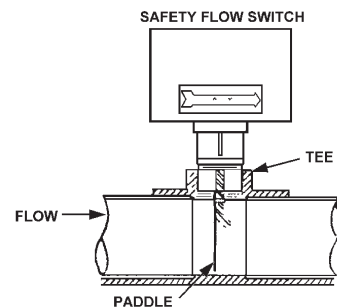

FIGURE 6. WATER FLOW SWITCH.

## FLAME SENSOR

Each Boiler is equipped with two flame sensors coupled together to detect the presence of the burner flames at high and low fire conditions. These flame sensors work together as one to sense the flame. If no flame is sensed, the gas valve(s) will close automatically. If no flame is sensed on three ignition trials, the boiler will lock out. In the event of a lockout, depress the SELECT button on the display board to restart the boiler.



## WATER TEMPERATURE LIMIT CONTROLS

### CAUTION

#### Limit Controls

Limit controls are safety devices and are NOT to be used as an operating device (thermostat).

The "V(B/W)" models incorporate an outlet water probe consisting of two limit controls:

1. A Manual Reset High limit control that can be set as high as either 210°F (99°C) or 235°F (113°C), depending on the application.
2. A fixed manual high limit, factory set at 244°F (118°C). If the manual reset should open due to high temperature, the gas valves will close and unit will go into lockout. If lockout occurs, push the SELECTION button on UIM to restart boiler.

## ON/OFF SWITCH

The ON/OFF Switch is a single-pole, single-throw rocker switch. This switch provides 120V from the line source to the boiler.

## CIRCULATING PUMP

**HOT WATER SUPPLY BOILER-VW**, the circulating pump is integral to the VW models. This pump has been lubricated at the factory, and future lubrication should be in accordance with the motor manufacturer's instructions provided as a supplement to this manual.

**HOT WATER HEATING BOILERS-VB**, the circulating pump is NOT provided on standard models (optional) and must be obtained and installed in the field.

**NOTE:** If a system pump is to be installed on a VB model, the maximum rating of pump motor must not exceed 1 hp.

## TEMPERATURE PROBES

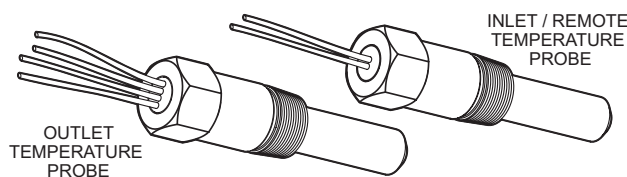

FIGURE 7. REMOTE PROBE INSTALLATION.

Temperature probes are 3/4 inch male NPT threaded immersion probes, see Figure 7. Temperature probes have embedded temperature sensors (thermistors). The boiler's control system monitors these sensors to determine water temperature at various points in the system.

## INLET AND OUTLET TEMPERATURE PROBES

All VF boilers have one Inlet and one Outlet Temperature Probe factory installed in the top of the heat exchanger to monitor the water temperature entering and leaving the boiler. The Inlet Probe is a temperature sensor only and has two leads. The Outlet probe also contains the manual reset high temperature limit switch and has four leads. The control system displays the Inlet and Outlet water temperatures sensed from these two probes on the default Temperatures screen.

## REMOTE TEMPERATURE PROBE

All VF boilers are supplied from the factory with a Remote Temperature Probe. The supplied Remote Temperature Probe is used to control system water temperature for a single boiler in a domestic hot water storage tank or in the return line from a primary/secondary hydronic heating system. Use of the Remote

Temperature Probe allows a boiler to sense the actual water temperature inside the storage tank or hydronic heating loop. The boiler will modulate its firing rate in response to the actual system temperature and load conditions. The control system displays the temperature sensed from the Remote Temperature Probe as the "Tank" temperature on the default Temperatures screen.

## QUAD THERMISTOR PROBE

When connecting up to 4 boilers to a single storage tank or one primary/secondary hydronic heating system the optional Quad Thermistor Probe should be used. The Quad Thermistor Probe is a remote temperature probe with four temperature sensors embedded in one device. The Quad Thermistor Probe allows up to 4 boilers to sense system temperature from same point in the system. Use of the Quad Thermistor Probe will allow each connected boiler to individually sense actual water temperature in the storage tank or hydronic heating loop. The temperatures sensed from each of the four temperature sensor circuits in a Quad Thermistor Probe are shown as "Tank" temperature on each boiler's default Temperatures screen.

**NOTE:** See the Field Wiring, Remote Temperature Probe Installation and the Primary System Control sections of this manual for operating and installation instructions.

## LOW WATER CUTOFF (OPTIONAL)

If boiler is installed above radiation level, a Low Water Cutoff Device must be installed in boiler outlet at time of installation or, order pre-installed from the factory. If low water detection is required by authorities having jurisdiction, a low water cutoff switch should be installed in the boiler outlet water line. The switch should receive periodic (every six months) inspection to assure proper operation.

## PRESSURE RELIEF VALVE

An ASME rated pressure relief valve is furnished with the boiler. Never operate the boiler if it is not filled with water and a properly sized pressure relief valve is not installed.

The pressure rating of the relief valve should be equal to or less than the rated pressure capacity of any component in the system including the boiler. Should the valve need to be replaced, call the toll free phone number listed on the back of this manual for further technical assistance.

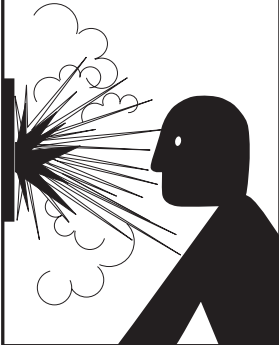
	<b>! WARNING</b>
	<b>Explosion Hazard</b>
	<ul style="list-style-type: none"><li>• Relief Valve must comply with ASME code.</li><li>• Properly sized Relief Valve must be installed.</li><li>• Can result in overheating and excessive tank pressure.</li><li>• Can cause serious injury or death.</li></ul>

A discharge pipe from the relief valve should terminate at an adequate floor drain. Do not thread, plug, or cap the end of drain line.

### CAUTION

#### Water Damage Hazard

- Pressure Relief Valve discharge pipe must terminate at adequate drain.

#### The Discharge Pipe:

- Shall not be smaller in size than the outlet pipe size of the valve, or have any reducing couplings or other restrictions.
- Shall not be plugged or blocked.
- Shall not be exposed to freezing temperatures.
- Shall be of material listed for hot water distribution.
- Shall be installed so as to allow complete drainage of both the relief valve and the discharge pipe.
- Must terminate a maximum of six inches above a floor drain or external to the building. In cold climates, it is recommended that the discharge pipe be terminated at an adequate drain inside the building.
- Shall not have any valve or other obstruction between the relief valve and the drain.

Once the boiler is installed and filled with water and the system is pressurized, manually test the operation of the pressure relief valve. See the maintenance section of this manual for instructions.

Your local code authority may have other specific safety relief valve requirements not covered below. If any pressure relief valve is replaced, the replacement valve must comply with the current version of the ASME Boiler and Pressure Vessel Code, Section IV ("HEATING BOILERS").

**VW HOT WATER SUPPLY BOILERS**, are shipped with a 125 psi (860kPa) pressure relief valve that must be installed in the water outlet as near to the boiler as possible.

This ASME-rated valve has a discharge capacity that exceeds maximum boiler input rating and a pressure rating that does not exceed maximum working pressure shown on boiler rating plate. In addition, a CSA design-certified and ASME-rated temperature and pressure (T&P) relief valve must be installed on each and every water storage tank in hot water supply system. The T&P relief valve must comply with applicable construction provisions of Standard for Relief Valves for Hot Water Supply Systems, ANSI Z21.22 or CSA 4.4. T&P relief valve must be of automatic reset type and not embody a single-use type fusible plug, cartridge or linkage.

T&P relief valve should have a temperature rating of 210°F (99°C), a pressure rating not exceeding lowest rated working pressure of any system component, and a discharge capacity exceeding total input of water boilers supplying water to storage tank.

Locate the T&P relief valve (a) in the top of the tank, or (b) in the side of the tank on a centerline within the upper 6 inches (152mm) of the top of the tank, see Figures 14 and 15. The tapping should be threaded in accordance with the current edition of the Standard for Pipe Threads, General Purpose (inch), ANSI/ASME B1.20.1. The location of, or intended location for, the T&P relief valve should be readily accessible for servicing or replacement.

**VB HOT WATER HEATING BOILERS**, are shipped with a 50 psi (345kPa) pressure relief valve. This relief valve must be installed in the water outlet as near to the boiler as possible.

## GENERAL

### REQUIRED ABILITY

INSTALLATION OR SERVICE OF THIS BOILER REQUIRES ABILITY EQUIVALENT TO THAT OF A LICENSED TRADESMAN IN THE FIELD INVOLVED. PLUMBING, AIR SUPPLY, VENTING, GAS SUPPLY, AND ELECTRICAL WORK ARE REQUIRED.

### LOCATION

When installing the boiler, consideration must be given to proper location. The location selected should provide adequate air supply and be as centralized with the piping system as possible.

### CAUTION

#### Property Damage Hazard

This boiler should not be installed on carpeting.

This boiler should not be located in an area where it may be subject to freezing.

This boiler must be located near a floor drain. It should be located in an area where leakage from the boiler or connections will not result in damage to the adjacent area or to lower floors of the structure.

### WARNING

#### Fire Hazard

Flammable items, pressurized containers, or any other potential fire hazardous articles must never be placed on or adjacent to the boiler. Open containers or flammable material should not be stored or used in the same room with the boiler.

### DANGER

#### Fire Explosion Hazard



There is a risk of fire or explosion in areas where gasoline, other flammable liquids, or engine driven equipment and vehicles are stored, operated, or repaired when a fuel burning appliance such as a boiler is operated.

Flammable vapors are heavy and travel along the floor. They may be ignited by sparks causing fire or explosion.

If the boiler is installed above radiation level, a **Low Water Cutoff Device** must be installed in the boiler outlet at the time of installation.

### PANELS AND COVERS

All panels and covers (e.g. control and junction box covers; front, side and rear panels of boiler, see Figure 8) MUST be in place after service and/or before operation of the boiler. This will ensure that all gas ignition components will be protected from water.

The VF is a low-pressure boiler (Category IV) to be used as either hot water supply (domestic/commercial water heating) or hot water heating (hydronic) application. Category IV boilers operate with a positive vent pressure and with a vent gas temperature less than 120°F (49°C) above its dew point. Category IV appliances are often termed "High Efficiency" appliances.

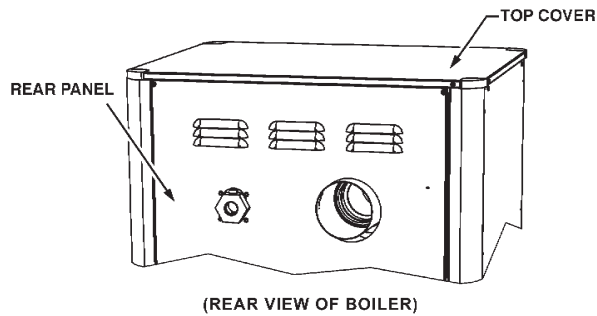

FIGURE 8.

## CHEMICAL VAPOR CORROSION

Boiler corrosion and component failure can be caused by the heating and breakdown of airborne chemical vapors. Spray can propellants, cleaning solvents, refrigerator and air conditioning refrigerants, swimming pool chemicals, calcium and sodium chloride (water softener salt), waxes, and process chemicals are typical compounds which are potentially corrosive. These materials are corrosive at very low concentration levels with little or no odor to reveal their presence.

Products of this sort should not be stored near the boiler. Also, air which is brought in contact with the boiler should not contain any of these chemicals. If necessary, uncontaminated air should be obtained from remote or outside sources. Failure to observe this requirement will void the warranty.

## INSTALLTION CLEARANCES

This boiler **MUST NOT** be installed on carpeted floors. This boiler is approved for installation on combustible flooring in an alcove with minimum clearances to combustibles of:

4" (102mm) Rear; 0" (0mm) Top and Sides; 6" (152mm) Vent. 2" (51mm) clearance is allowable from combustible construction for hot water pipes.

Sufficient area should be provided at the front and rear of the unit for proper servicing. Service clearances of 24" (610mm) in front, rear, top and sides are recommended. In a utility room installation, the door opening shall be wide enough to allow the boiler to enter or to permit the replacement of another appliance such as a boiler.

## LEVELING

Each unit should be checked after installation to be certain that it is level.

If the unit is not level, obtain and insert shims under the feet at the frame base to correct this condition.

## AIR REQUIREMENTS

<b>! WARNING</b>	
<b>Breathing Hazard - Carbon Monoxide Gas</b>	
	<ul style="list-style-type: none"> <li>• Install appliance in accordance with the Instruction Manual and NFPA 54 or CAN/CSA-B149.1.</li> <li>• To avoid injury, combustion and ventilation air must be taken from outdoors.</li> <li>• Do not place chemical vapor emitting products near water heater.</li> </ul>
Breathing carbon monoxide can cause brain damage or death. Always read and understand instruction manual.	

## UNCONFINED SPACE

In buildings of conventional frame, brick or stone construction, unconfined spaces may provide adequate air for combustion.

If the unconfined space is within a building of tight construction (buildings using the following construction: weather stripping, heavy insulation, caulking, vapor barrier, etc.), air for combustion, ventilation, and draft hood dilution must be obtained from outdoors or spaces freely communicating with the outdoors. The installation instructions for confined spaces in tightly constructed buildings must be followed to ensure adequate air supply.

## UNUSUALLY TIGHT CONSTRUCTION

In unconfined spaces in buildings, infiltration may be adequate to provide air for combustion, ventilation and dilution of flue gases. However, in buildings of unusually tight construction (for example, weather stripping, heavily insulated, caulked, vapor barrier, etc.) additional air must be provided using the methods described in the Confined Space section that follows.

## CONFINED SPACE

A Confined Space is one whose volume is less than 50 cubic feet per 1,000 Btu/hr (4.8 cm per kW) of the total input rating of all appliances installed in the space.

Openings must be installed to provide fresh air for combustion, ventilation and dilution in confined spaces. The required size for the openings is dependent on the method used to provide fresh air to the confined space and the total Btu/hr input rating of all appliances installed in the space.

## DIRECT VENT APPLIANCES

Appliances installed in a Direct Vent configuration that derive all air for combustion from the outdoor atmosphere through sealed intake air piping are not factored in the total appliance input Btu/hr calculations used to determine the size of openings providing fresh air into confined spaces.

## EXHAUST FANS

Where exhaust fans are installed, additional air should be provided to replace the exhausted air. When an exhaust fan is installed in the same space with a water heater, sufficient openings to provide fresh air must be provided that accommodate the requirements for all appliances in the room and the exhaust fan. Undersized openings will cause air to be drawn into the room through the appliance vent system causing poor combustion. Sooting, serious damage to the appliance and the risk of fire or explosion may result. It can also create a risk of asphyxiation.

## LOUVERS AND GRILLES

The free areas of the fresh air openings in the instructions that follow do not take in to account the presence of louvers, grilles or screens in the openings.

The required size of openings for combustion, ventilation and dilution air should be based on the "net free area" of each opening. Where the free area through a design of louver or grille or screen is known, it should be used in calculating the size of opening required to provide the free area specified. Where the louver and grille design and free area are not known, it should be assumed that wood louvers will have 25% free area and metal louvers and grilles will have 75% free area. Non motorized louvers and grilles should be fixed in the open position.

## FRESH AIR OPENINGS FOR CONFINED SPACES

The following instructions should be used to calculate the size, number and placement of openings providing fresh air for combustion, ventilation and dilution in confined spaces. The illustrations shown in this section of the manual are a reference

for the openings that provide fresh air into confined spaces only. Do not refer to these illustrations for the purpose of vent installation. See Venting Installation on page 18 for complete venting installation instructions.

### OUTDOOR AIR THROUGH TWO OPENINGS

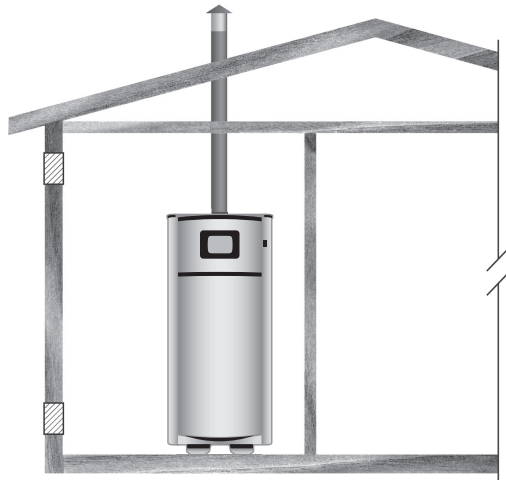

**FIGURE 9A.**

The confined space should be provided with two permanent openings, one commencing within 12 inches (300 mm) of the top and one commencing within 12 inches (300 mm) of the bottom of the enclosure. The openings should communicate directly with the outdoors. See Figure 9A.

Each opening should have a minimum free area of 1 square inch per 4,000 Btu/hr (550 mm<sup>2</sup> per kW) of the aggregate input rating of all appliances installed in the enclosure. Each opening should not be less than 100 square inches (645 cm<sup>2</sup>).

### OUTDOOR AIR THROUGH ONE OPENING

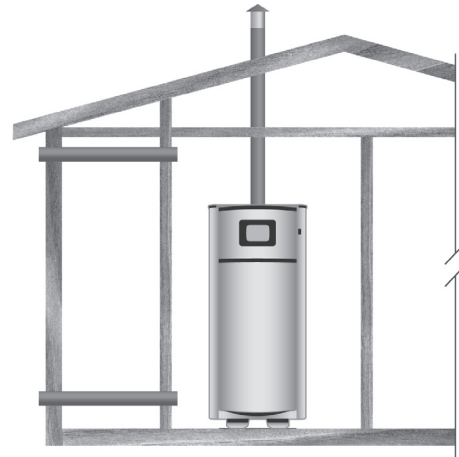

**FIGURE 9B.**

Alternatively a single permanent opening, commencing within 12 inches (300 mm) of top of enclosure, should be provided. See Figure 9B. The appliance should have clearances of at least 1 inch (25 mm) from sides and back and 6 inches (150 mm) from front. The opening should directly communicate with outdoors or should communicate through a vertical or horizontal duct to outdoors or spaces that freely communicate with outdoors and should have a minimum free area of the following:

1. 1 square inch per 3000 Btu/hr (700 mm<sup>2</sup> per kW) of the total input rating of all appliances located in the enclosure, and
2. Not less than the sum of areas of all vent connectors in the space.

### OUTDOOR AIR THROUGH TWO HORIZONTAL DUCTS



**FIGURE 9C.**

The confined space should be provided with two permanent horizontal ducts, one commencing within 12 inches (300 mm) of the top and one commencing within 12 inches (300 mm) of the bottom of the enclosure. The horizontal ducts should communicate directly with the outdoors. See Figure 9C.

Each duct opening should have a minimum free area of 1 square inch per 2,000 Btu/hr (1100 mm<sup>2</sup> per kW) of the aggregate input rating of all appliances installed in the enclosure.

When ducts are used, they should be of the same cross sectional area as the free area of the openings to which they connect. The minimum dimension of rectangular air ducts should be not less than 3 inches.

### OUTDOOR AIR THROUGH TWO VERTICAL DUCTS

The illustrations shown in this section of the manual are a reference for the openings that provide fresh air into confined spaces only.

Do not refer to these illustrations for the purpose of vent installation. See Venting Installation on page 19 for complete venting installation instructions.

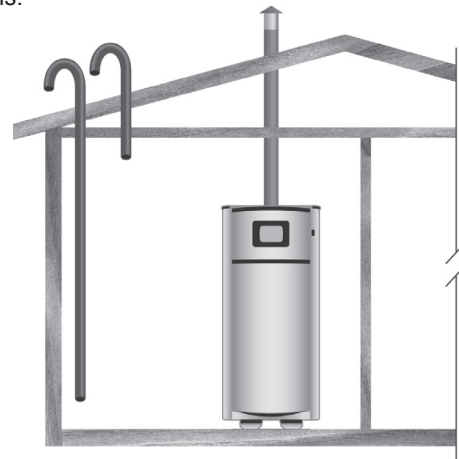

**FIGURE 9D.**

The confined space should be provided with two permanent vertical ducts, one commencing within 12 inches (300 mm) of the top and one commencing within 12 inches (300 mm) of the bottom of the enclosure. The vertical ducts should communicate directly with the outdoors. See Figure 9D.

Each duct opening should have a minimum free area of 1 square inch per 4,000 Btu/hr (550 mm<sup>2</sup> per kW) of the aggregate input rating of all appliances installed in the enclosure.

When ducts are used, they should be of same cross sectional area as free area of openings to which they connect. The minimum dimension of rectangular air ducts should be not less than 3 inches.

## AIR FROM OTHER INDOOR SPACES

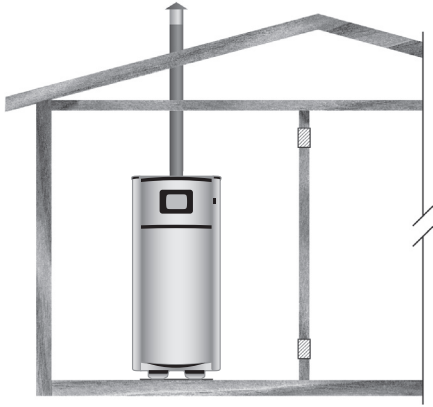

FIGURE 9E.

The confined space should be provided with two permanent openings, one commencing within 12 inches (300 mm) of the top and one commencing within 12 inches (300 mm) of the bottom of the enclosure. See Figure 9E.

Each opening should communicate directly with an additional room(s) of sufficient volume so that the combined volume of all spaces meets the criteria for an Unconfined Space.

Each opening should have a minimum free area of 1 square inch per 1,000 Btu/hr (1100 mm<sup>2</sup> per kW) of the aggregate input rating of all appliances installed in the enclosure. Each opening should not be less than 100 square inches (645 cm<sup>2</sup>).

# TERMINATION CLEARANCES SIDEWALL POWER VENT

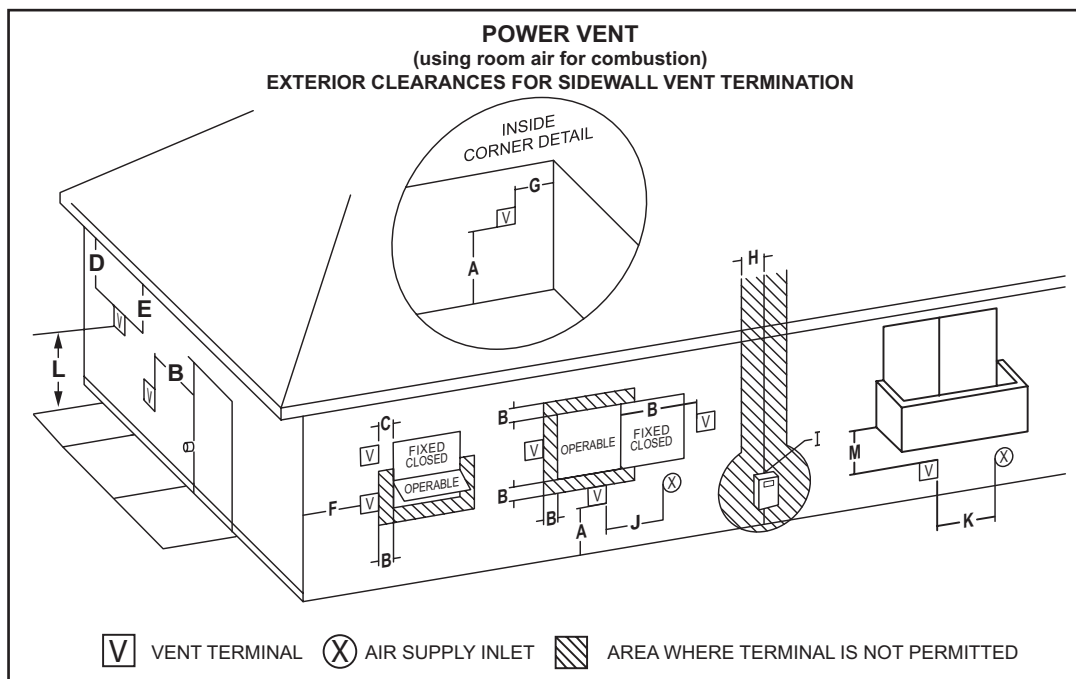

Figure 9F.

Vent terminal clearances for "Power Vent" installations. Power Vent configurations use room air for combustion.

	CANADIAN INSTALLATIONS <sup>1</sup>		US INSTALLATIONS <sup>2</sup>		CANADIAN INSTALLATIONS <sup>1</sup>		US INSTALLATIONS <sup>2</sup>	
<b>A</b>	Clearance above grade, veranda, porch, deck or balcony	12 inches (30 cm)	12 inches (30 cm)	<b>H</b>	Clearance to each side of center line extended above meter/regulator assembly	3 feet (91 cm) within a height 15 feet (4.5 m) above the meter/regulator assembly	3 feet (91 cm) within a height 15 feet (4.5 m) above the meter/regulator assembly*	
<b>B</b>	Clearance to window or door that may be opened	6 inches (15 cm) for appliances up to 10,000 Btu/hr (3 kW), 12 inches (30 cm) for appliances between 10,000 Btu/hr (3 kW) and 100,000 Btu/hr (30 kW), 36 inches (91 cm) for appliances above 100,000 Btu/hr (30 kW)	4 feet (1.2 m) below or to side of opening; 1 foot (30 cm) above opening	<b>I</b>	Clearance to service regulator vent outlet	3 feet (91 cm)	3 feet (91 cm)*	
<b>C</b>	Clearance to permanently closed window	12 inches (30 cm)*	12 inches (30 cm)*	<b>J</b>	Clearance to a non mechanical air supply inlet into building or combustion air inlet to any other appliance	6 inches (15 cm) for appliances up to 10,000 Btu/hr (3 kW), 12 inches (30 cm) for appliances between 10,000 Btu/hr (3 kW) and 100,000 Btu/hr (30kW), 36 inches (91cm) for appliances above 100,000 Btu/hr (30 kW)	4 feet (1.2 m) below or to side of opening; 1 foot (30 cm) above opening.	
<b>D</b>	Vertical clearance to ventilated soffit located above the terminal within a horizontal distance of 2 feet (61 cm) from the center line of the terminal	12 inches (30 cm)*	12 inches (30 cm)*	<b>K</b>	Clearance to a mechanical air supply inlet	6 feet (1.83 m)	3 feet (91 cm) above if within 10 feet (3 m) horizontally	
<b>E</b>	Clearance to unventilated soffit	12 inches (30 cm)*	12 inches (30 cm)*	<b>L</b>	Clearance above paved sidewalk or paved driveway located on public property	7 feet (2.13 m)†	7 feet (2.13 m)	
<b>F</b>	Clearance to outside corner	2 feet (60 cm)*	2 feet (60 cm)*	<b>M</b>	Clearance under veranda, porch, deck, or balcony	12 inches (30 cm) ‡	12 inches (30 cm) ‡	
<b>G</b>	Clearance to inside corner	8 ft. (2.44 m)*	8 ft. (2.44 m)*					

1 In accordance with the current CSA B149.1, Natural Gas and Propane Installation Code.

2 In accordance with the current ANSI Z223.1/NFPA 54, National Fuel Gas Code.

† A vent should not terminate directly above a sidewalk or paved driveway that is located between two single family dwellings and serves both dwellings.

‡ Permitted only if veranda, porch, deck, or balcony is fully open on a minimum of two sides beneath the floor.

\* Clearance in accordance with local installation codes and the requirements of the gas supplier and the manufacturer's installation instructions.

# TERMINATION CLEARANCES SIDEWALL DIRECT VENT

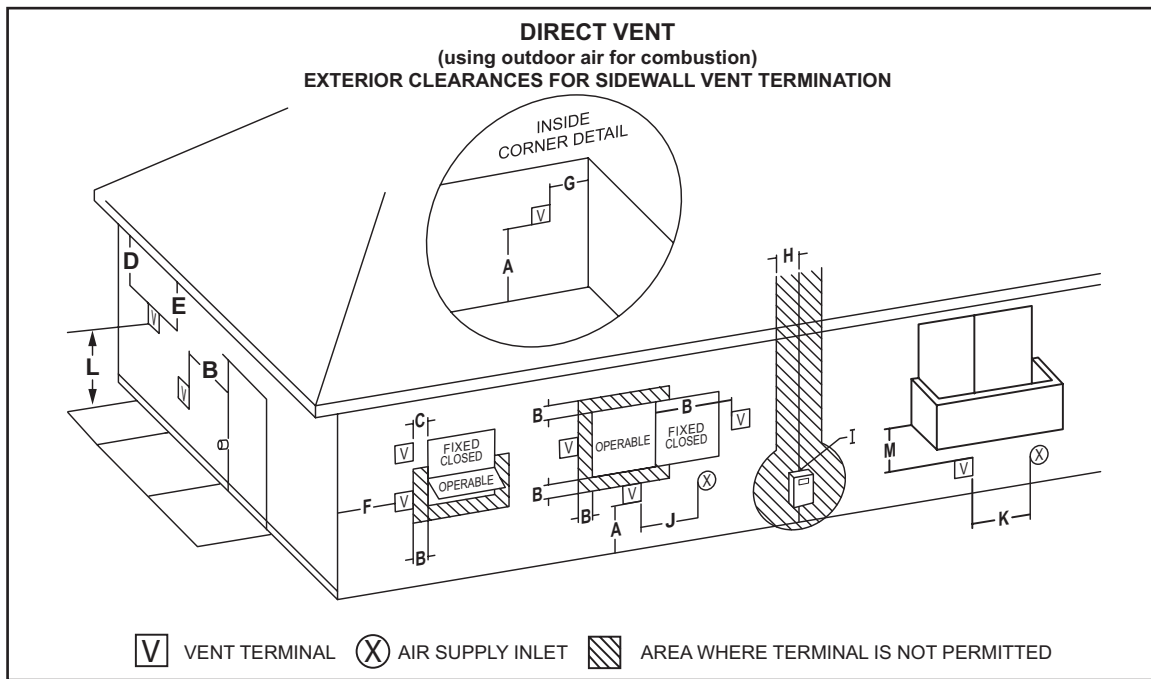

Figure 9G.

Vent terminal clearances for "Direct Vent" installations. Direct Vent configurations use outdoor air for combustion.

		CANADIAN INSTALLATIONS <sup>1</sup>	US INSTALLATIONS <sup>2</sup>		CANADIAN INSTALLATIONS <sup>1</sup>	US INSTALLATIONS <sup>2</sup>
<b>A</b>	Clearance above grade, veranda, porch, deck or balcony	12 inches (30 cm)	12 inches (30 cm)	<b>H</b>	Clearance to each side of center line extended above meter/regulator assembly	3 feet (91 cm) within a height 15 feet (4.5 m) above the meter/regulator assembly
<b>B</b>	Clearance to window or door that may be opened	6 inches (15 cm) for appliances up to 10,000 Btu/hr (3 kW), 12 inches (30 cm) for appliances between 10,000 Btu/hr (3 kW) and 100,000 Btu/hr (30 kW), 36 inches (91 cm) for appliances above 100,000 Btu/hr (30 kW)	6 inches (15 cm) for appliances up to 10,000 Btu/hr (3 kW), 9 inches (23 cm) for appliances between 10,000 Btu/hr (3 kW) and 50,000 Btu/hr (15 kW), 12 inches (30 cm) for appliances above 50,000 Btu/hr (15 kW)	<b>I</b>	Clearance to service regulator vent outlet	3 feet (91 cm)
<b>C</b>	Clearance to permanently closed window	6 inches (15 cm)*	6 inches (15 cm)*	<b>J</b>	Clearance to a non mechanical air supply inlet into building or combustion air inlet to any other appliance	6 inches (15 cm) for appliances up to 10,000 Btu/hr (3 kW), 12 inches (30 cm) for appliances between 10,000 Btu/hr (3 kW) and 100,000 Btu/hr (30 kW), 36 inches (91 cm) for appliances above 100,000 Btu/hr (30 kW)
<b>D</b>	Vertical clearance to ventilated soffit located above the terminal within a horizontal distance of 2 feet (61 cm) from the center line of the terminal	12 inches (30 cm)*	12 inches (30 cm)*	<b>K</b>	Clearance to a mechanical air supply inlet	6 feet (1.83 m)
<b>E</b>	Clearance to unventilated soffit	12 inches (30 cm)*	12 inches (30 cm)*	<b>L</b>	Clearance above paved sidewalk or paved driveway located on public property	7 feet (2.13 m)†
<b>F</b>	Clearance to outside corner	2 feet (60 cm)*	2 feet (60 cm)*	<b>M</b>	Clearance under veranda, porch, deck, or balcony	12 inches (30 cm) ‡
<b>G</b>	Clearance to inside corner	8 ft. (2.44 m)*	8 ft. (2.44 m)*			12 inches (30 cm) ‡*

<sup>1</sup> In accordance with the current CSA B149.1, Natural Gas and Propane Installation Code.

<sup>2</sup> In accordance with the current ANSI Z223.1/NFPA 54, National Fuel Gas Code.

† A vent should not terminate directly above a sidewalk or paved driveway that is located between two single family dwellings and serves both dwellings.

‡ Permitted only if veranda, porch, deck, or balcony is fully open on a minimum of two sides beneath the floor.

\* Clearance in accordance with local installation codes and the requirements of the gas supplier and the manufacturer's installation instructions.

# VENTING

## ⚠ CAUTION

### Proper Draft

Proper draft must be maintained to ensure correct operation of this unit.

## ⚠ WARNING

### Fire and Breathing Hazard



The instructions in this section on venting the boiler must be followed to avoid choked combustion or recirculation of flue gases. Such conditions cause sooting or risks of fire and asphyxiation.



VENT SIZING, INSTALLATION AND TERMINATION SHALL BE IN ACCORDANCE WITH THIS INSTALLATION MANUAL.

**ALL ELECTRICAL POWER AND GAS MUST BE TURNED OFF PRIOR TO ANY INSTALLATION OF THE VENTING SYSTEM.**

### SPECIAL INSTALLATION CONSIDERATIONS

This boiler is a category IV appliance that can be vented using room air for intake combustion air, or direct vented so that all intake air for combustion comes from the outside through a sealed pipe. When installing this boiler as direct vent, special vent kits are required.

In cold climates any water vapor remaining in the flue gases will condense into a cloud of vapor at the point where the vent system exits the building. Special consideration is recommended, before locating the vent termination near walkways, windows and building entrances.

Direct venting into dead spaces such as alleys, atriums, and inside corners can cause recirculation of flue gases. Recirculation of flue gases will cause sooting, premature failure of the heat exchanger, and icing of the combustion air intake during severe cold weather. To prevent the recirculation of flue gases, maintain as much distance as possible between the combustion air intake and the exhaust vent terminal. Due to large volumes of flue gases, multiple boiler applications also require additional distance between the intake and exhaust terminals.

### VENTING SYSTEM USING AL 29-4C®

This boiler may be installed in four separate orientations depending on the requirements of the building and the appliance. The installer must decide which method is most appropriate for each installation. These orientations are:

1. **Vertical Termination** - vertical vent termination through un-enclosed or enclosed areas with roof penetration, see Figure 11.

2. **Through-the-Wall Termination (TWT)** - horizontal vent termination directly through an outside wall, see Figure 11A.
3. **Horizontal Direct Vent** - using TWT to exhaust flue products and PVC piping to bring combustion air to the boiler from the outside, see Figures 12 and 12C.
4. **Vertical Direct Vent** - using a vertical vent termination to exhaust flue products and PVC piping to bring combustion air to the boiler from outside, see Figures 12A and 12B.

### GENERAL EXHAUST VENT INSTALLATION PROCEDURE

Prior to beginning the installation of the vent system, determine and obtain all parts required for the installation. IF THIS INSTALLATION IS A DIRECT VENT INSTALLATION A DIRECT VENT KIT IS REQUIRED. REFER TO THE PARTS LIST FOR KIT NUMBER.

Proper operation of the boiler and venting system is dependent upon use of all specified parts and installation techniques; both safety and proper performance of the system may suffer if instructions are not followed.

### CONNECTING VENT TO BOILER

Referring to Figure 10., combustion gases are vented using AL29-4C material. Transition from the horizontal outlet to a vertical vent is achieved through the use of a boot-tee and drain cover or other engineering approved arrangement. A support bracket should be located at the transition point.

The drain connection is necessary for the removal of condensate which may form in the stack. A rubber hose 3/8" ID and 10 feet long is provided for directing the condensate to a suitable drain.

1. Attach the Boot Tee Drain Cover to the appropriate leg of the Boot-Tee, see Figure 10.
2. A trap loop must be formed into the drain tube simply by looping the tube to a minimum 3 inch (76mm) diameter and secure the loop with a cable tie, see Figure 10.
3. Prior to final assembly the trap loop must be "primed" by pouring a small quantity of water into the drain hose.
4. Connect the Boot-Tee and Drain Tee assembly (or engineering approved equivalent) to the boiler vent connector, see Figure 10.
5. Attach the hose to the drain fitting and run the hose to a sanitary sewer drain maintaining the proper trap loop and following all local, state and federal codes and regulations for draining of acidic effluent (condensate).

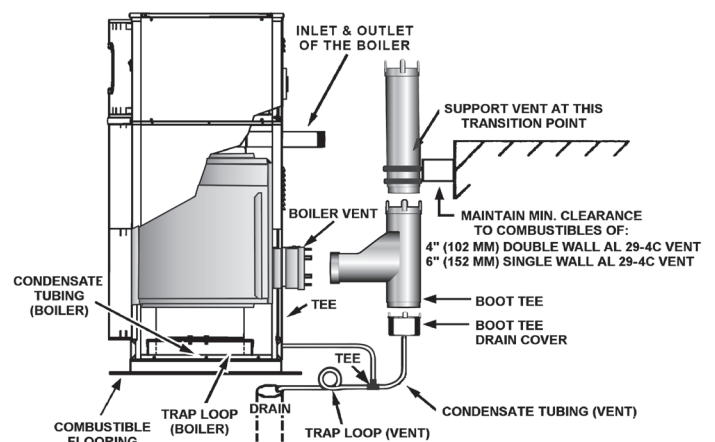

Figure 10.



## VENTING SUPPORTS

Care must be taken in the installation of the venting system that adequate support is maintained throughout the installation process. When extending more than 10 feet (3.0m) vertically, vertical support kits are required once every 10 feet (3.0m) of vertical run. Vertical support is also required immediately after any transition (elbow, tee, etc.) to vertical of over 10 feet (3.0m) of run and after any offset in the vertical run.

The support brackets (supplied in the Vertical Support Kit) are to be securely fastened to a solid vertical member of the building using the appropriate fasteners; i.e., wood screws for wood framing, machine or tapping screws for structural steel or masonry anchors for solid masonry. The bracket should be located so that it will not interfere with any joints of the venting system. The bottom most support bracket should be located directly above the first transition from horizontal to vertical, see Figure 10. Refer to Figures 12, 12A, 12B and 12C.

If a means of support for the brackets are not available and horizontal vent sections are present, install hanger straps (made from non-combustible material) as close to the points of transition as possible. If the horizontal portions of the vent and/or vent connector are longer than 6 feet (2.0m), then install hanger straps every 6 feet (2.0m) to support the connector.

**DO NOT rivet or screw the straps to the conduit or otherwise puncture the conduit wall. Instead, wrap an extra loop of strap around the conduit to hold it in position, or attach the strap to the center screw of the double wall AL 29-4C® vent coupling, if applicable.**

## VERTICAL INSTALLATION REQUIREMENTS

1. The vent system must terminate at least 3 feet (1.0m) and no more than 6 feet (2.0m) above the roof line and no closer than 10 feet (3.0m) from any wall or vertical structure. If the exhaust vent terminal is within 10 feet (3.0m) of a wall or parapet, it must extend a minimum of 2 feet (610mm) above the wall or parapet, see Figures 11 and 12A.
2. For direct vent installations, the total distance of the vent system from the boiler vent connector to the vertical vent termination shall not exceed 70 equivalent feet (21.3m). A maximum of three 90° elbows can be used. Minimum vertical vent is 7 equivalent feet (2.1m) for direct vent installations. Standard minimum vertical vent length is 7 feet (2.1m), plus Boot-Tee. See Figures 11, 12A, 12B, and 12C for differences between standard and direct vent installations.
3. An AL 29-C® Vent Vertical Vent Terminal must be used at the termination.

4. Maintain a minimum of 6 feet (2.0m) separation between the air intake and the exhaust terminals.

## HORIZONTAL INSTALLTION REQUIREMENTS

1. The vent system must terminate with a AL 29-4C® Vent Through-the-Wall Termination (TWT). Plan the terminal location based on the dimensions shown in Figure 9. Do not locate the terminal within 8 feet (2.5m) of an inside corner of a building or adjacent to outside walls, shrubs or other such objects that may cause adverse wind conditions in the immediate area.
2. The TWT shall be located not less than 12 inches (305mm) above grade or, in geographical areas where snow accumulates, no less than 12 inches (305mm) above the anticipated snow line. Ensure that the TWT is protected against blockage which may occur during ice buildup or snowstorms.

The TWT shall terminate at least 3 feet (1.0m) above any forced air inlet within 10 feet (3.0m), except when the forced air inlet is the combustion air intake of a direct vent appliance. The TWT shall terminate at least 4 feet (1.2m) below, 4 feet (1.2m) horizontally from or 1 foot (305mm) above any door, window or gravity air inlet into any building as provided in the current edition of the NATIONAL FUEL GAS CODE ANSI Z223.1, see Figure 9.

In addition, a minimum clearance of 4 feet (1.2m) horizontally from, and in NO CASE ABOVE OR BELOW, unless the 4 feet (1.2m) of horizontal distance is maintained from electric meters, gas meters, regulators and relief equipment.

3. This horizontal exhaust vent system must pitch upward toward the termination at 1/4 inch per foot (21mm per meter).
4. The TWT is designed such that the building is protected from degradation by flue gas and condensate. However, if additional protection is desired, install against the wall a non-corrosive metal sheet under the TWT.
5. Due to the normal formation of water vapor in the combustion process, horizontal terminations must not be located over areas of pedestrian or vehicular traffic, (i.e., public walkways or over areas where condensate could create a nuisance or hazard). This is especially true in colder climates where ice buildup is likely to occur. A.O. Smith Corporation will not be held liable for any personal injury or property damage due to any dislodging of ice.

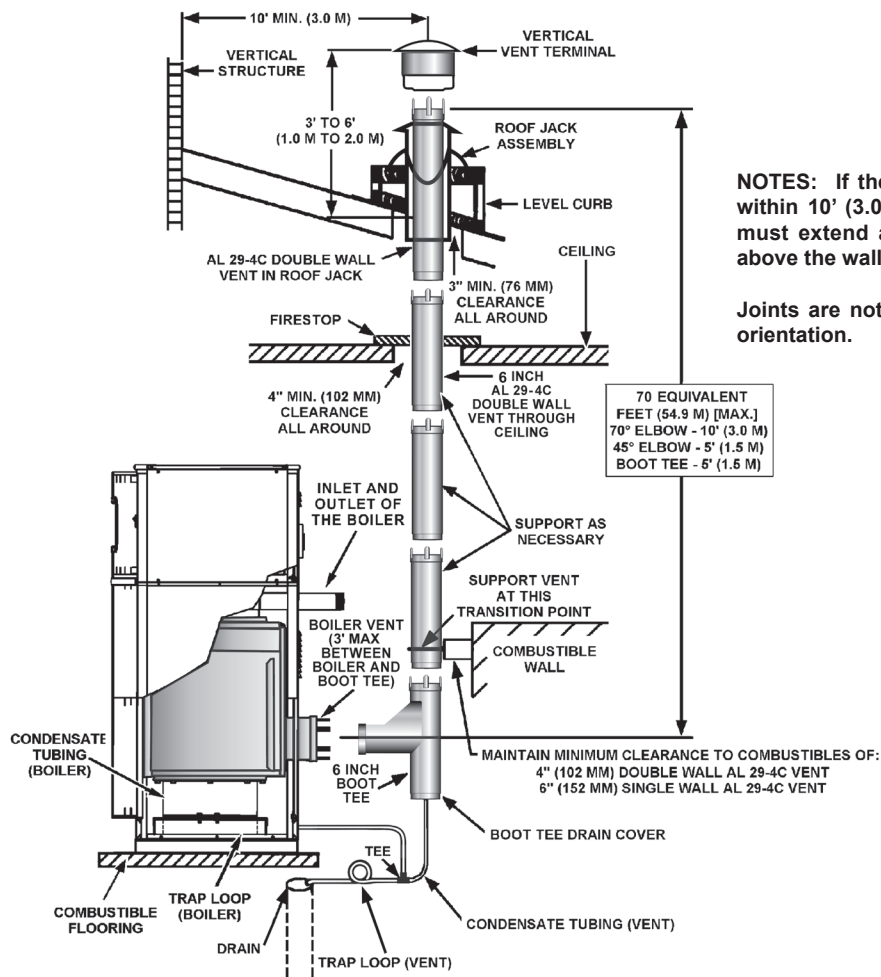

NOTES: If the exhaust vent terminal is within 10' (3.0m) of a wall or parapet, it must extend a minimum of 2' (610mm) above the wall or parapet.

Joints are not joined to show vent pipe orientation.

FIGURE 11. VERTICAL TERMINATION.

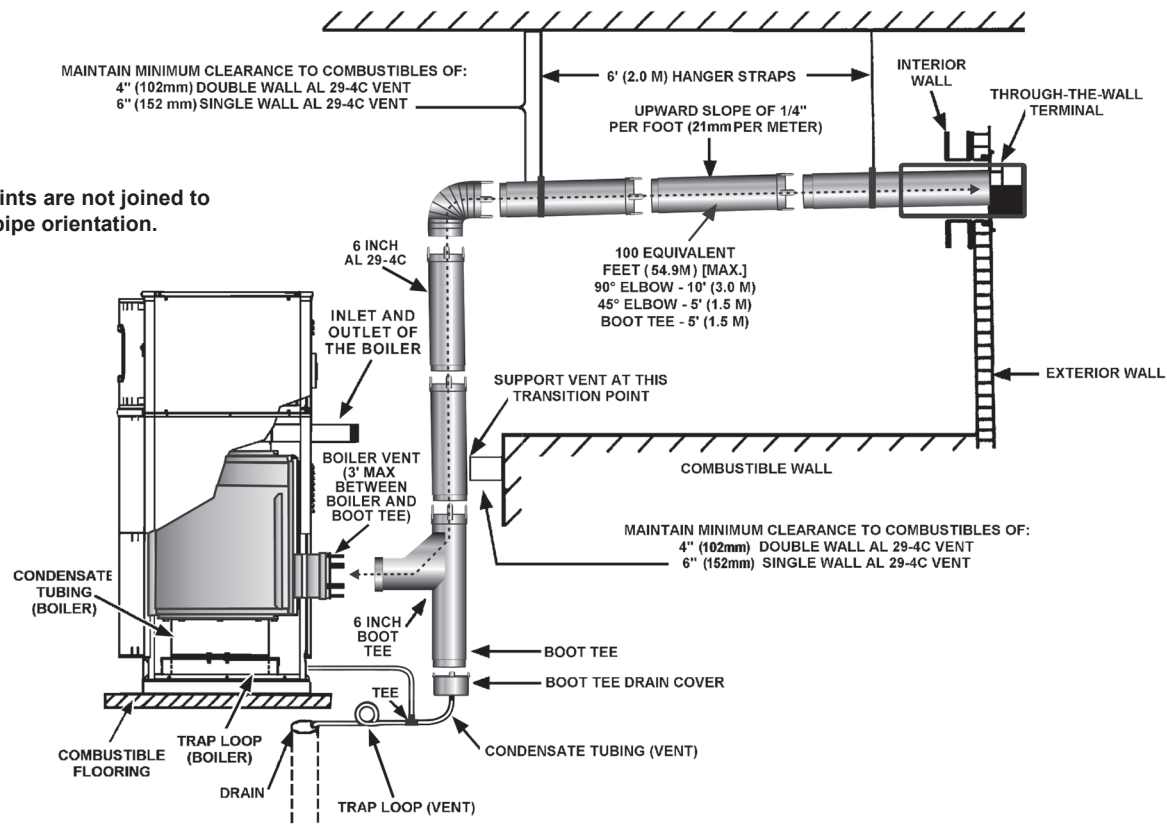

NOTES: Joints are not joined to show vent pipe orientation.

FIGURE 11A. HORIZONTAL THROUGH THE WALL TERMINATION (TWT).

## DIRECT VENT INSTALLATION REQUIREMENTS

Follow the guidelines in the "HORIZONTAL INSTALLATION REQUIREMENTS" section for the exhausting of flue products.

### IMPORTANT

The labels in the Direct Vent Kit must be affixed to the boiler in locations specified by the instruction sheet provided in the kit. The following are requirements for the Air-Intake Terminal (AIT):

1. The Air-Intake System (AIS) must terminate with the venting equipment provided with the boiler, Refer to the parts list for required direct vent parts.
2. The AIT shall not be located less than 3 feet (1.0m) below any exhaust vent within 10 feet (3.0m), see "HORIZONTAL INSTALLATION REQUIREMENTS" section.
3. The total horizontal distance of the AIS from the boiler's Blower Adapter to the outside of the "AIT" shall not be greater than 70 "equivalent" feet (21.3m) of vent pipe nor less than 3 feet (1.0m), excluding elbows. A maximum of 3 elbows, equivalent to 10 feet (3.0m) each of pipe may be used.

## INSTALLATION REQUIREMENTS FOR THE COMMONWEALTH OF MASSACHUSETTS

For all side wall terminated, horizontally vented power vent, direct vent, and power direct vent gas fueled water heaters installed in every dwelling, building or structure used in whole or in part for residential purposes, including those owned or operated by the Commonwealth and where the side wall exhaust vent termination is less than seven (7) feet above finished grade in the area of the venting, including but not limited to decks and porches, the following requirements shall be satisfied:

**INSTALLATION OF CARBON MONOXIDE DETECTORS** At the time of installation of the side wall horizontally vented gas fueled equipment, the installing plumber or gasfitter shall observe that a hard wired carbon monoxide detector with an alarm and battery back-up is installed on the floor level where the gas equipment is to be installed. In addition, the installing plumber or gasfitter shall observe that a battery operated or hard wired carbon monoxide detector with an alarm is installed on each additional level of the dwelling, building or structure served by the sidewall horizontally vented gas fueled equipment. It shall be the responsibility of the property owner to secure the services of qualified licensed professionals for the installation of hard wired carbon monoxide detectors.

In the event that the side wall horizontally vented gas fueled equipment is installed in a crawl space or an attic, the hard wired carbon monoxide detector with alarm and battery back-up may be installed on the next adjacent floor level.

In the event that the requirements of this subdivision can not be met at the time of completion of installation, the owner shall have a period of thirty (30) days to comply with the above requirements provided that during said thirty (30) day period, a battery operated carbon monoxide detector with an alarm shall be installed.

**APPROVED CARBON MONOXIDE DETECTORS** Each carbon monoxide detector as required in accordance with the above provisions shall comply with NFPA 720 and be ANSI/UL 2034 listed and CSA certified.

**SIGNAGE** A metal or plastic identification plate shall be permanently mounted to the exterior of the building at a minimum height of eight (8) feet above grade directly in line with the exhaust vent terminal for the horizontally vented gas fueled heating appliance or equipment. The sign shall read, in print size no less than one-half (1/2) inch in size, "**GAS VENT DIRECTLY BELOW. KEEP CLEAR OF ALL OBSTRUCTIONS.**"

**INSPECTION** The state or local gas inspector of the side wall horizontally vented gas fueled equipment shall not approve the installation unless, upon inspection, the inspector observes carbon monoxide detectors and signage installed in accordance with the provisions of 248 CMR 5.08(2)(a) 1 through 4.

**EXEMPTIONS:** The following equipment is exempt from 248 CMR 5.08(2)(a)1 through 4:

1. The equipment listed in Chapter 10 entitled "Equipment Not Required To Be Vented" in the most current edition of NFPA 54 as adopted by the Board; and
2. Product Approved side wall horizontally vented gas fueled equipment installed in a room or structure separate from the dwelling, building, or structure used in whole or in part for residential purposes.

**MANUFACTURER REQUIREMENTS - GAS EQUIPMENT VENTING SYSTEM PROVIDED** When the manufacturer of Product Approved side wall horizontally vented gas equipment provides a venting system design or venting system components with the equipment, the instructions provided by the manufacturer for installation of the equipment and the venting system shall include:

1. Detailed instructions for the installation of the venting system design or the venting system components; and
2. A complete parts list for the venting system design or venting system.

**MANUFACTURER REQUIREMENTS - GAS EQUIPMENT VENTING SYSTEM NOT PROVIDED** When the manufacturer of a Product Approved side wall horizontally vented gas fueled equipment does not provide the parts for venting the flue gases, but identifies "special venting systems," the following requirements shall be satisfied by the manufacturer:

1. The referenced "special venting system" instructions shall be included with the appliance or equipment installation instructions; and
2. The "special venting systems" shall be Product Approved by the Board, and the instructions for that system shall include a parts list and detailed installation instructions.

A copy of all installation instructions for all Product Approved side wall horizontally vented gas fueled equipment, all venting instructions, all parts lists for venting instructions, and/or all venting design instructions shall remain with the appliance or equipment at the completion of the installation.

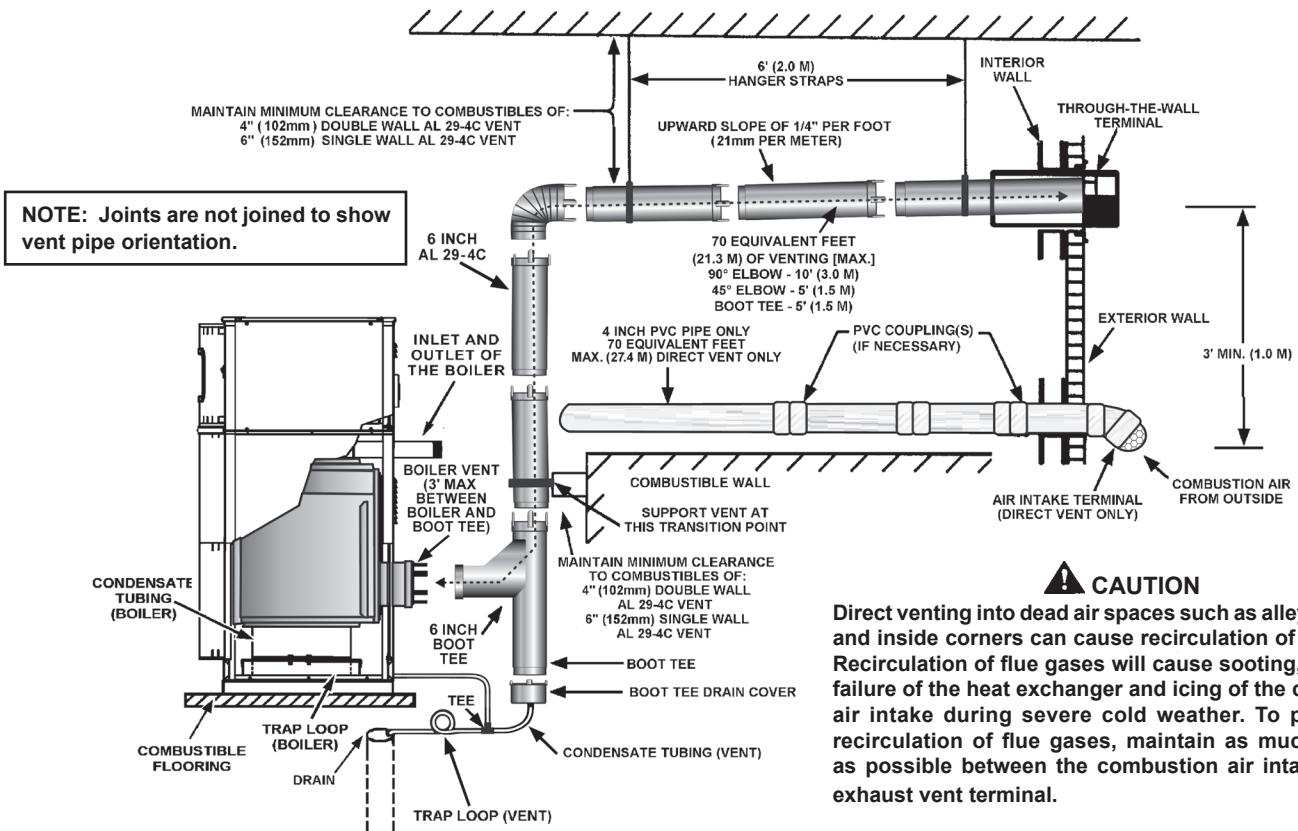

**CAUTION**

Direct venting into dead air spaces such as alleys, atriums, and inside corners can cause recirculation of flue gases. Recirculation of flue gases will cause sooting, premature failure of the heat exchanger and icing of the combustion air intake during severe cold weather. To prevent the recirculation of flue gases, maintain as much distance as possible between the combustion air intake and the exhaust vent terminal.

FIGURE 12. DIRECT VENT HORIZONTAL.

**CAUTION**  
 Direct venting into dead air spaces such as; alleys, atriums and inside corners can cause recirculation of flue gases. Recirculation of flue gases will cause sooting, premature failure of the heat exchanger and icing of the combustion air intake during severe cold weather. To prevent the recirculation of flue gases, maintain as much distance as possible between the combustion air intake and the exhaust vent terminal.

NOTES: If the exhaust vent terminal is within

10' (3.0m) of a wall or parapet, it must extend a minimum of 2' (610mm) above the wall or parapet.

Joints are not joined to show vent pipe orientation.

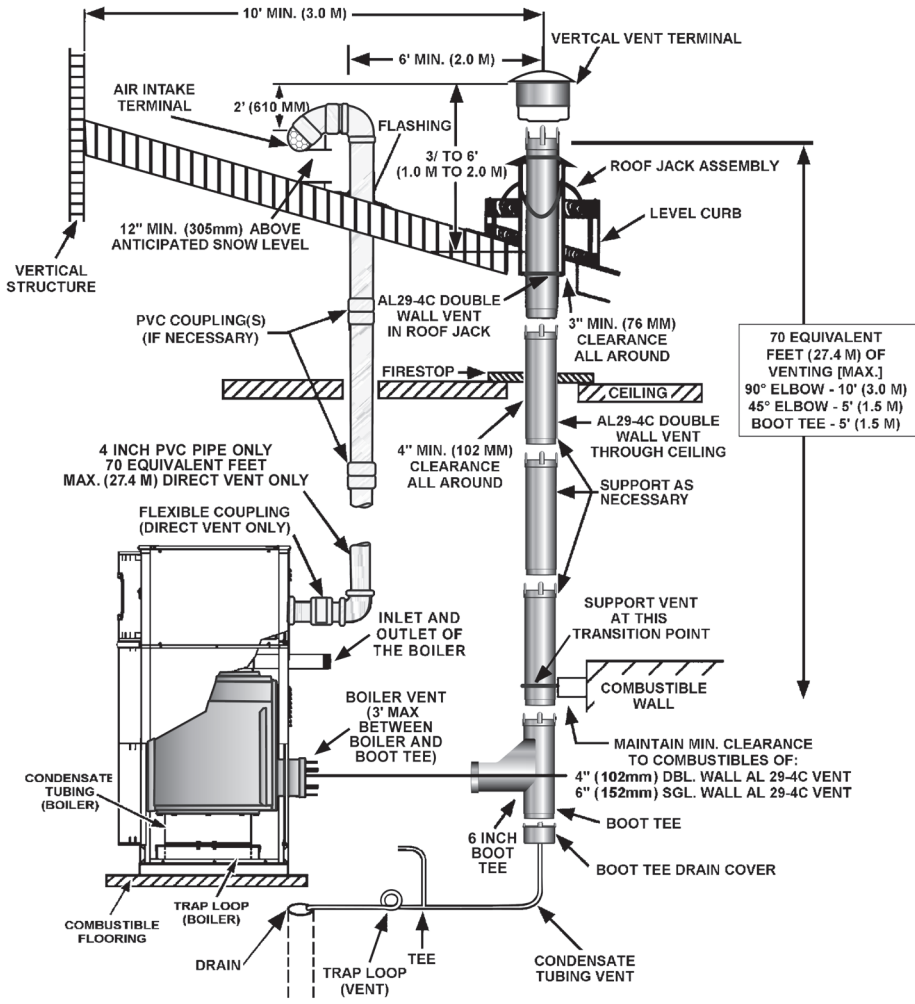
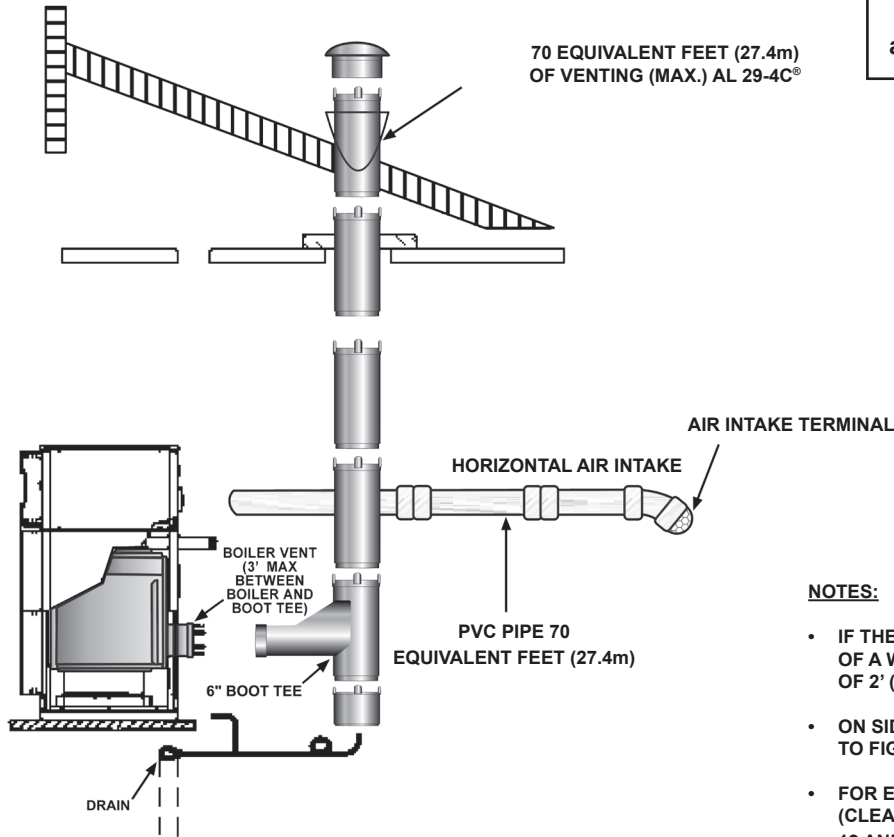

FIGURE 12A. DIRECT VENT VERTICAL.

**Option B (Figures 12B & 12C)  
assures no recirculation of flue gases.**



**NOTES:**

- IF THE EXHAUST VENT TERMINAL IS WITHIN 10' (3.0m) OF A WALL OR A PARAPET, IT MUST EXTEND A MINIMUM OF 2' (0.6m) ABOVE THE WALL OR PARAPET.
- ON SIDEWALL VENT INSTALLATION, REFER TO FIGURE 9F FOR SPACING SPECIFICATIONS
- FOR EXHAUST AND AIR INTAKE PIPE INSTALLATIONS (CLEARANCES, SUPPORT, ETC.) REFER TO FIGURES 12 AND 12A.

**FIGURE 12B. DIRECT VENT, VERTICAL VENT TERMINATION WITH HORIZONTAL INTAKE.**

**VERTICAL AIR INTAKE MUST BE 12" (305mm) ABOVE ANTICIPATED SNOW LEVEL.**

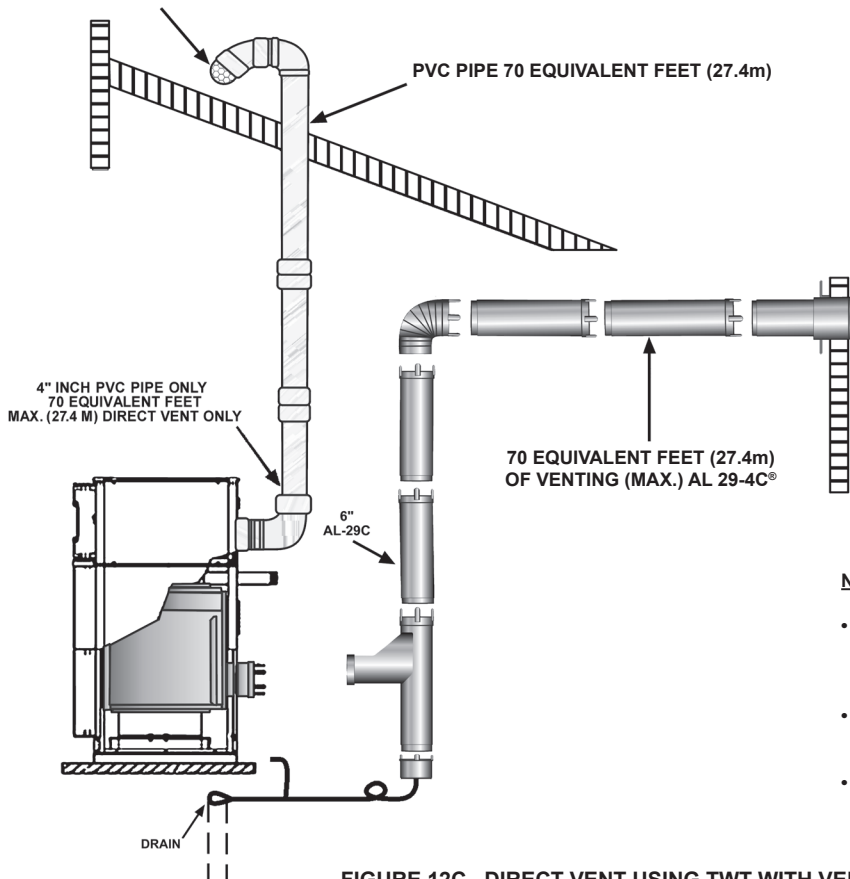

**NOTES:**

- IF THE EXHAUST VENT TERMINAL IS WITHIN 10' (3.0m) OF A WALL OR A PARAPET, IT MUST EXTEND A MINIMUM OF 2' (0.6m) ABOVE THE WALL OR PARAPET.
- ON SIDEWALL VENT INSTALLATION, REFER TO FIGURE 9G FOR SPACING SPECIFICATIONS
- FOR EXHAUST AND AIR INTAKE PIPE INSTALLATIONS (CLEARANCES, SUPPORT, ETC.) REFER TO FIGURES 12 AND 12A.

**FIGURE 12C. DIRECT VENT USING TWT WITH VERTICAL INTAKE.**

# SYSTEM INSTALLATION

## GENERAL

If the system is to be filled with water for testing or other purposes during cold weather and before actual operation, care must be taken to prevent a downdraft entering the boiler or freezing air from contacting the system. Failure to do so may cause the water in the system to freeze with resulting damage to the system. **DAMAGE DUE TO FREEZING IS NOT COVERED BY THE WARRANTY.**

Good practice requires that all heavy piping, etc., be supported.

Figure 13 shows a typical primary, secondary piping method. This is the preferred piping method for most copper fin tube boilers. Other piping methods, however, may provide good system operation. A prime concern when designing heating systems is the maintenance of proper flow through the unit during boiler operation. The secondary pump should be sized per the recommended flow rate of the boiler, see Dimension and Capacity Data in this manual.

A system bypass should be installed, as shown in Figure 13, to prevent boiler circulation starvation when the system zones call for reduced flow.

This bypass may also be used with multiple boilers manifolded for reverse-return flow. This system bypass would be installed from boiler outlet to suction side of pump.

## HOT WATER HEATING (HYDRONIC) EQUIPMENT

The following is a brief description of the equipment required for the installations noted in this manual. All installations must comply with local code.

### 1. WATER SUPPLY LINE

These boilers can be used **ONLY** in a forced circulation hot water heating system. Since most forced circulation systems will be of the closed type, install the water supply line as shown on piping diagram, see Figure 13.

Fast filling of large pipe, old radiator installations and pressure purging of series loop systems (where high pressures are not available) requires bypassing of the pressure reducing valve.

Generally, pressure purging is not possible with a well pump system. High point air venting is essential.

If the system is of the open type, a pressure reducing valve will not be required as the water supply to the system will be controlled by a manually operated valve. An overhead surge tank is required. A minimum pressure of 15 psi (100kPa) must be maintained on the boiler at all times to ensure avoidance of potential damage to the boiler which may not be covered by the warranty.

### 2. EXPANSION TANK

If the system is of the closed type, install an expansion tank as shown in Figure 13. The sizing of the expansion tank for a closed system is very important and is directly

related to the total water volume of the system. Refer to "Systems and Equipment" volume of the ASHRAE handbook.

An air separator as shown in the piping diagrams is recommended especially for modern commercial hydronic systems.

### 3. VENT VALVES

It is recommended that automatic, loose key or screw-driver type vent valves be installed at each convector or radiator.

### 4. SYSTEM HEADERS

Split systems with individual supply and return lines from the boiler room should normally have this piping connected to supply and return manifold headers near the boiler. To achieve good water distribution with maximum pressure drop for several circuits, manifolds should be larger than system mains.

The circuits should be spaced on the heater at a minimum of 3" (76mm) center to center. Install a balancing cock in each return line.

Manifold headers are recommended for split systems with or without zone valves and also those installations with zone circulators. If the system is to be split at remote points, good practice requires special attention be given to main pipe sizing to allow balancing of water flow.

### 5. COOLING PIPING

When the boiler is used in conjunction with a refrigeration system it must be installed so that the chilled medium is piped in parallel with the boiler. Appropriate flow control valves, manual or motorized, must be provided to prevent the chilled medium from entering the boiler.

Water temperature in the heating system must be reduced to less than 100°F (38°C) before cooling system is started, or damage to the chiller unit may occur.

If the boiler is connected to chilled water piping or its heating coils are exposed to refrigerated air, the boiler piping system must be equipped with flow valves or other automatic means to prevent gravity circulation through the boiler during the cooling cycle.

Primary/secondary pumping of both the chiller(s) and the boiler(s) is an excellent winter-summer change-over method, because cooling flow rates are so much more than heating flow rates. In this way each system (heating or cooling) is circulated independently.

### 6. CIRCULATING PUMP

**FOR HOT WATER HEATING BOILERS - VB MODELS**, the circulating pump is NOT provided and must be field-installed.

**NOTE: If a system pump is to be installed on a VB model, the maximum rating of the pump motor must not exceed 1 hp.**

## 7. SYSTEM CONTROLLER

Controlling of these systems is decided mainly by the type of building system controlling desired. A single boiler installation might be controlled directly from space temperature thermostat(s). Multiple boiler installations are more effective when the boilers are sequenced in and out of operation by some form of main water temperature controller. With one or two boilers, individual control settings at progressive temperature may be used. For more than two boilers, electronic sequencing controlling is recommended. Individual controls, or the separate stages of a step controller, should start the boiler loop circulator and fire the boiler. Some large installations may require the firing of more than one boiler per stage.

The system or primary circulator may or may not be controlled by the boiler sequencer. When this pump is operated through the first switch of any type of step controller, care should be taken to determine if a motor starter is needed due to insufficient switch capacity.

Multiple boiler installations are especially adapted to the use of outdoor reset for main water temperatures. This feature is not mandatory, but offers smooth, efficient operation of a modern system.

Normal use of flow control valves is required to prevent cross circulation of zones as with any multiple pump system.

Large systems with multiple boilers should include main water temperature controls (with or without outdoor reset) to sequence the boiler on and off, in relation to the load on the system.

**24VAC System Controller (Optional)** - VB models require a field supplied 24VAC operating control to be installed in the system such as: loop thermostat, indoor/outdoor reset control, sequencing panel, or energy management system. The connection for such devices is located in the junction box at the rear of the unit. A 24VAC thermostat/aquastat can only be used as an "On/Off" switch for the unit. The actual controlling of the phasing will be through either the inlet or remote probe. To use a 24VAC system controller, dipswitch "4" on the MCB must be switched to the "on" position, see REMOTE PROBE INSTALLATION.

## INTERNAL CONTAMINANTS

The hydronic system must be internally cleaned and flushed after a new or replacement boiler has been installed, to remove contaminants that may have accumulated during installation. This is extremely important when a replacement boiler is installed into an existing system where Stop Leak or other boiler additives have been used.

Failure to clean and flush the system can produce acid concentrations that become corrosive, and leads to heat exchanger failure.

All hot water heating systems should be completely flushed with a grease removing solution to assure trouble-free operation. Pipe joint compounds, soldering paste, grease on tubing and pipe all tend to contaminate a system

Failure to flush contaminants from a system can cause solids to form on the inside of boiler exchangers, create excessive blockage of water circulation, deterioration of the pumps seal and impellers.

## HOT WATER SUPPLY BOILER SYSTEM - GENERAL WATER LINE CONNECTIONS

This section provides detailed installation diagrams for a typical method of application for the unit.

Piping diagrams will serve to provide the installer with a reference for the materials and methods of piping necessary for installation. It is essential that all water piping be installed and connected as shown on the diagrams. Check the diagrams to be used thoroughly before starting installation to avoid possible errors and to minimize time and material cost.

It is essential that all water piping be installed and connected as shown on the diagrams. Check the diagrams to be used thoroughly before starting installation to avoid possible errors and to minimize the time and material cost.

## HARD WATER CONDITIONS

Where hard water conditions exist, water softening or the threshold type of water treatment is recommended. This will protect the dishwashers, coffee urns, water heaters, water piping and other equipment. When water softening or water treatment is not practical, a comparatively easy method of periodic lime removal from the unit may be employed.

SHUTOFF VALVES SHOULD BE INSTALLED FOR SERVICING BOILER, HOWEVER, LOCAL CODES SHALL GOVERN THEIR USAGE.

## THERMAL EXPANSION (CLOSED SYSTEM)

As water is heated, it expands (thermal expansion). In a closed system the volume of water will grow when it is heated. As the volume of water grows there will be a corresponding increase in water pressure due to thermal expansion. Thermal expansion can cause premature tank failure (leakage). This type of failure is not covered under the limited warranty. Thermal expansion can also cause intermittent Temperature-Pressure Relief Valve operation: water discharged from the valve due to excessive pressure build up. This condition is not covered under the limited warranty. The Temperature-Pressure Relief Valve is not intended for the constant relief of thermal expansion.

A properly sized thermal expansion tank must be installed on all closed systems to control the harmful effects of thermal expansion. Contact a local plumbing service agency to have a thermal expansion tank installed.

## REMOTE PROBE INSTALLATION PROCEDURE

A remote probe is supplied with each hot water supply boiler (VW models). To connect the remote probe to the boiler, remove the cover from the junction box at the rear of the unit. Connect the probe wire pigtailed, see Figure 7. Check the field connection diagram located on this cover of the junction box to assure proper wiring.

Once the remote probe has been connected to the boiler, it must be designated as the controlling probe for the system.

This is accomplished by changing two dipswitch settings on the MCB. First, dipswitch “4” must be set to the “ON” position to designate the remote probe as the controlling probe. Second, dipswitch “1” must be set to the “OFF” position to limit the maximum remote probe temperature for VW applications. Also, make sure dipswitch “1” is set to the “OFF” position, which sets the outlet temperature for VW applications. Failure to do this will void the warranty. If the remote probe is not designated as the controlling probe, the unit will be controlled by the inlet probe and will not use the desired tank temperature as its base.

Refer to Connection Diagram, Figure 17, in order to connect the remote probe to the boiler, see Tables 9, 10, 13 and 14 for Dipswitch positions.

## GAS CONNECTIONS

<b>⚠ CAUTION</b>
<b>Gas Supply</b>
<ul style="list-style-type: none"> <li>• The gas type must match the gas type on the rating plate.</li> <li>• Gas supply pressure must match pressure indicated on the rating plate</li> <li>• Isolate boiler from gas supply piping system.</li> <li>• Disconnect boiler and main manual gas shutoff valve from gas supply during pressure testing of gas supply system</li> </ul>

Make sure the gas on which the boiler is to operate is the same as that specified on the rating plate. Do not install the boiler if equipped for a different type of gas. Consult your gas supplier.

This boiler is not intended to operate at gas supply pressure other than shown on the rating plate. A lock-up or positive shut-off type regulator must be installed in the gas supply line. Exposure to higher gas supply pressure may cause damage to gas valves which can result in fire or explosion. If overpressure has occurred such as through improper testing of gas lines or emergency malfunction of the supply system, the gas valves must be checked for safe operation. Make sure that the outside vents on the supply regulators and the safety vent valves are protected against blockage. These are parts of the gas supply system, not the boiler. Vent blockage may occur during ice build-up or snowstorms.

The boiler must be isolated from the gas supply piping system by closing its main manual gas shut-off valve during any pressure testing of the gas supply piping system at test pressures equal to or less than 1/2 psig.

Disconnect the boiler and its main manual gas shut-off valve from the gas supply piping during any pressure testing of the gas supply system over 1/2 psig. The gas supply line must be capped when not connected to the boiler.

It is important to guard against gas valve fouling from contaminants in the gas ways. Such fouling may cause improper operation, fire or explosion. If copper supply lines are used they must be approved for gas service.

When local codes require a main manual shut-off valve outside the boiler jacket, a suitable main manual shut-off valve must be installed in a location complying with those codes.

Before attaching the gas line be sure that all gas pipe is clean on the inside.

To trap any dirt or foreign material in the gas supply line, a drip leg (sediment trap) must be incorporated in the piping. The drip leg must be readily accessible and not subject to freezing conditions. Install in accordance with recommendations of serving gas supplier. Refer to the current edition of the national fuel gas code, ANSI Z223.1 or CAN/CSA – B149.1, and current addenda.

Size of gas supply piping may be larger than heater connection on installations where a significant run of piping is required.

To prevent damage, care must be taken not to apply too much torque when attaching gas supply pipe to boiler gas inlet.

Fittings and unions in the gas line must be of the metal to metal type.

Apply joint compounds (pipe dope) sparingly and only to the male threads of pipe joints. Do not apply compound to the first two threads. Use compounds resistant to the action of liquefied petroleum gases.

### GAS SUPPLY LINE SIZING

The gas piping installation must be capable of supplying the maximum probable gas demand without excessive pressure loss. Depending on local practices, the ALLOWABLE PRESSURE LOSS between the gas meter, or service regulator and each appliance is generally 0.3 or 0.5 inches of water column (0.075 or 0.124kPa).

For single boiler installation, refer to Table 5 for appropriate pipe length for the appliance maximum rate.

For multiple boilers refer to Table 6 for natural gas and Table 7 for propane. Maximum pressure drop is 0.5 for these charts.

Reference tables are from ANSI Z223.1 National Fuel Gas Code or CAN/CSA-B149.1-00 (and current addenda):

Natural gas is 1000 BTU/ft<sup>3</sup> @ 0.6 specific gravity

Propane gas is 2500 BTU/ft<sup>3</sup> @ 1.5 specific gravity

< pipe length longer than 200 feet consult applicable codes

No additional allowance is necessary for an ordinary number of fittings. Where it is necessary to use more than the average number of fittings (i.e., elbows, tees and valves in gas supply line) use a pipe larger than specified to compensate for increased pressure drop.

**TABLE 5.**  
**SINGLE UNIT INSTALLATION, SUGGESTED GAS PIPE SIZING.**  
**MAXIMUM EQUIVALENT PIPE LENGTH (IN FEET).**

Nom. Pipe	0.3 in w.c. drop							
	1"		1.25"		1.5"		2"	
BTU input	Nat	Prop	Nat	Prop	Nat	Prop	Nat	Prop
500,000	10	25	40	90	80	200	200	
750,000		10	10	40	40	90	125	<
1,000,000			10	20	20	50	70	175
Nom. Pipe	0.5 in w.c. drop							
	1"		1.25"		1.5"		2"	
BTU input	Nat	Prop	Nat	Prop	Nat	Prop	Nat	Prop
500,000	10	40	60	150	150	200	<	
750,000		10	30	70	70	150	200	
1,000,000		10	10	40	30	90	125	<



# TYPICAL PRIMARY, SECONDARY PIPING.

## LEGEND

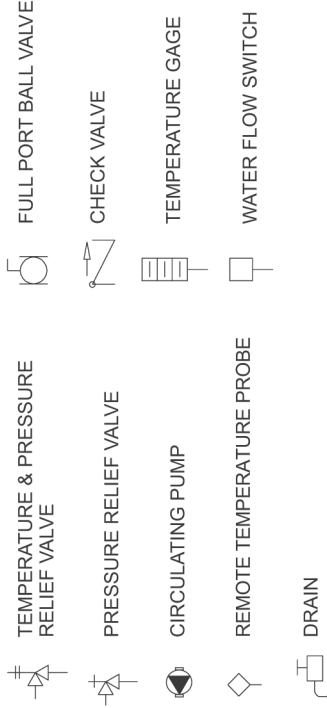

**VF BOILER, VB(500-1000) - ONE BOILER PRIMARY/SECONDARY HYDRONIC PIPING SYSTEM**

**CAUTION: THIS DRAWING SHOWS SUGGESTED PIPING CONFIGURATION AND OTHER DEVICES; CHECK WITH LOCAL CODES AND ORDINANCES FOR ADDITIONAL REQUIREMENTS.**

- INSTALL IN ACCORDANCE WITH ALL LOCAL CODES.
- WHEN BLOW DOWN VALVE IS REQUIRED, INSTALL IN PLACE OF THE DRAIN VALVE SHOWN.

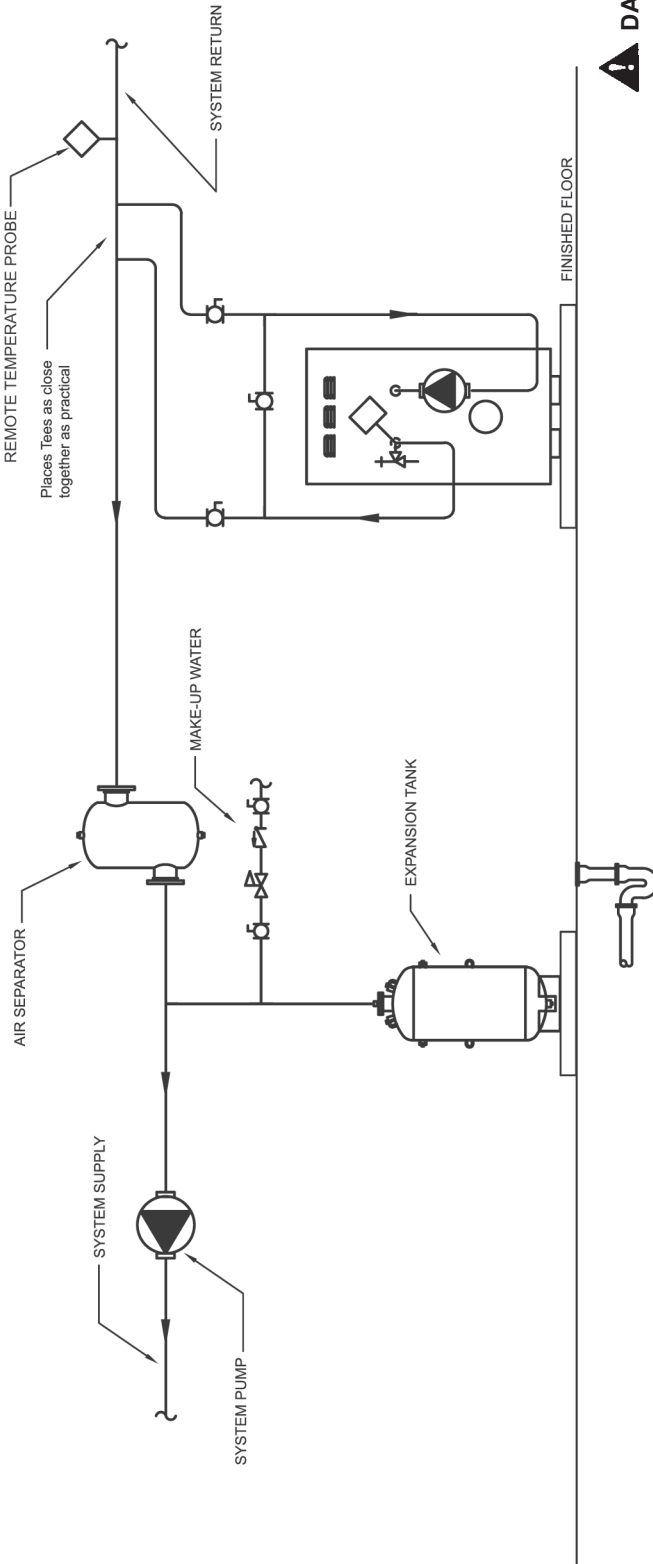

### NOTES:

1. Preferred piping layout.
2. The temperature and pressure relief valve setting shall not exceed pressure rating of any component in the system.
3. Service valves are shown for servicing boiler. However, local codes shall govern their usage.
4. Factory supplied pump is sized based on 50 equivalent feet of piping. (supply and return)



**TEMPERATURE SETTINGS SHOULD NOT EXCEED SAFE USE TEMPERATURE AT FIXTURES. IF HIGHER PREHEAT TEMPERATURES ARE NECESSARY TO OBTAIN ADEQUATE BOOSTER OUTPUT, ADD AN ANTI-SCALD VALVE FOR HOT WATER SUPPLIED TO FIXTURES, SEE TABLE 8.**

FIGURE 13. TYPICAL PRIMARY, SECONDARY PIPING.









# ONE VF (MODEL VW) HOT WATER SUPPLY BOILER WITH VERTICAL TANK

**VF BOILERS VW(500-1000) - ONE BOILER/VERTICAL STORAGE TANK RECOVERY SYSTEM (ONE TEMPERATURE)**

**CAUTION: THIS DRAWING SHOWS SUGGESTED PIPING CONFIGURATION AND OTHER DEVICES; CHECK WITH LOCAL CODES AND ORDINANCES FOR ADDITIONAL REQUIREMENTS.**

- INSTALL IN ACCORDANCE WITH ALL LOCAL CODES.
- WHEN BLOW DOWN VALVE IS REQUIRED, INSTALL IN PLACE OF THE DRAIN VALVE SHOWN.

## LEGEND

	TEMPERATURE & PRESSURE RELIEF VALVE		FULL PORT BALL VALVE
	PRESSURE RELIEF VALVE		CHECK VALVE
	CIRCULATING PUMP		TEMPERATURE GAGE
	REMOTE TEMPERATURE PROBE		WATER FLOW SWITCH
	DRAIN		

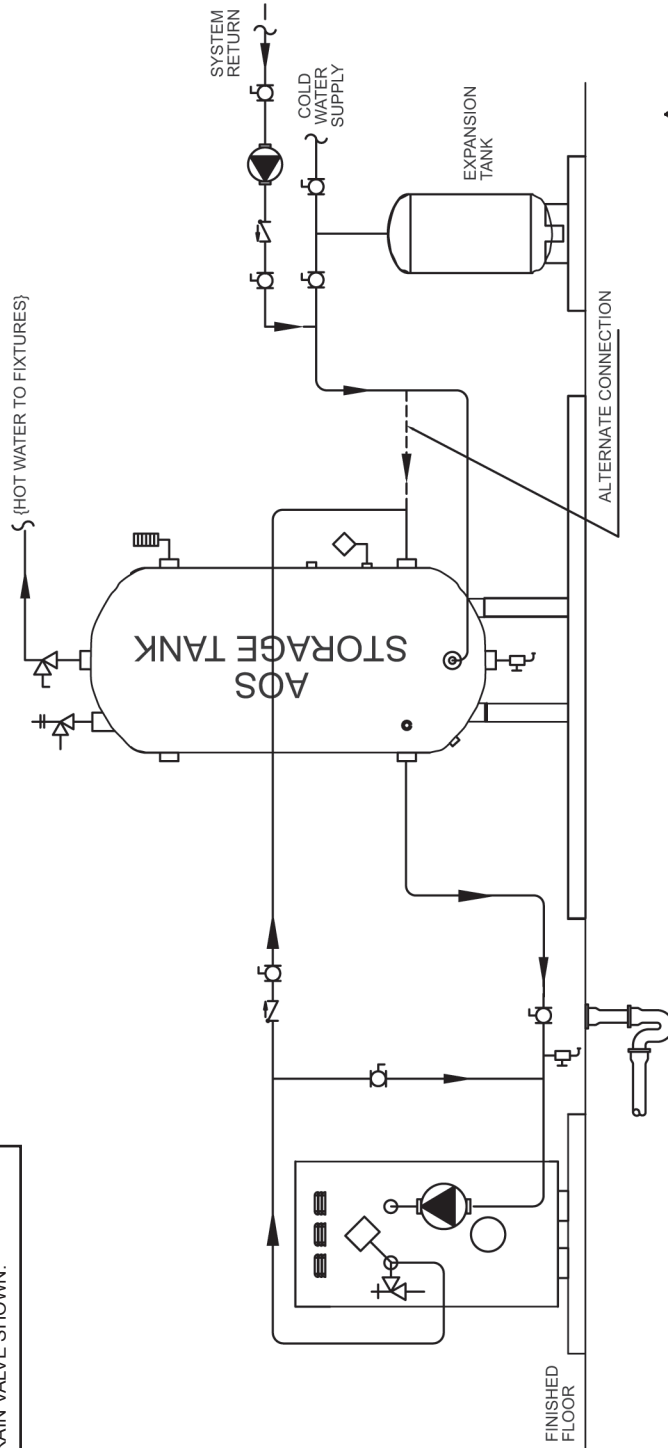

**NOTES:**

1. Preferred piping layout.
2. The temperature and pressure relief valve setting shall not exceed pressure rating of any component in the system.
3. Service valves are shown for servicing boiler. However, local codes shall govern their usage.
4. Maximum piping length between tank and boiler should not exceed a total of 50 equivalent feet constructed of 2 inch pipe size or larger.



**DANGER**

**TEMPERATURE SETTING SHOULD NOT EXCEED SAFE USE TEMPERATURE AT FIXTURES. IF HIGHER PREHEAT TEMPERATURES ARE NECESSARY TO OBTAIN ADEQUATE BOOSTER OUTPUT, ADD AN ANTI-SCALD VALVE FOR HOT WATER SUPPLIED TO FIXTURES, SEE TABLE 8.**

**FIGURE 14.**

# ONE VF (MODEL VW) HOT WATER SUPPLY BOILER WITH HORIZONTAL TANK

## LEGEND

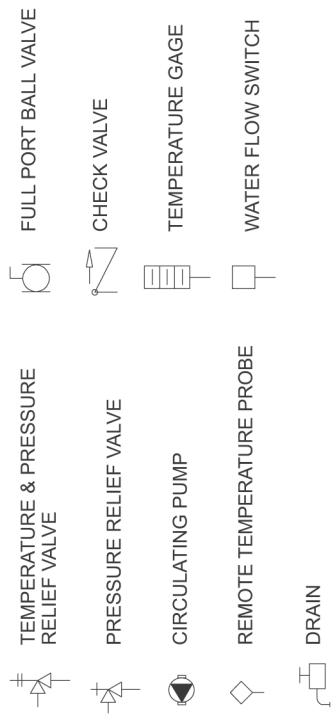

**VF BOILERS VW(500-1000)** - ONE BOILER/HORIZONTAL STORAGE TANK RECOVERY SYSTEM (ONE TEMPERATURE)

**CAUTION:** THIS DRAWING SHOWS SUGGESTED PIPING CONFIGURATION AND OTHER DEVICES; CHECK WITH LOCAL CODES AND ORDINANCES FOR ADDITIONAL REQUIREMENTS.

- INSTALL IN ACCORDANCE WITH ALL LOCAL CODES.
- WHEN BLOW DOWN VALVE IS REQUIRED, INSTALL IN PLACE OF THE DRAIN VALVE SHOWN.

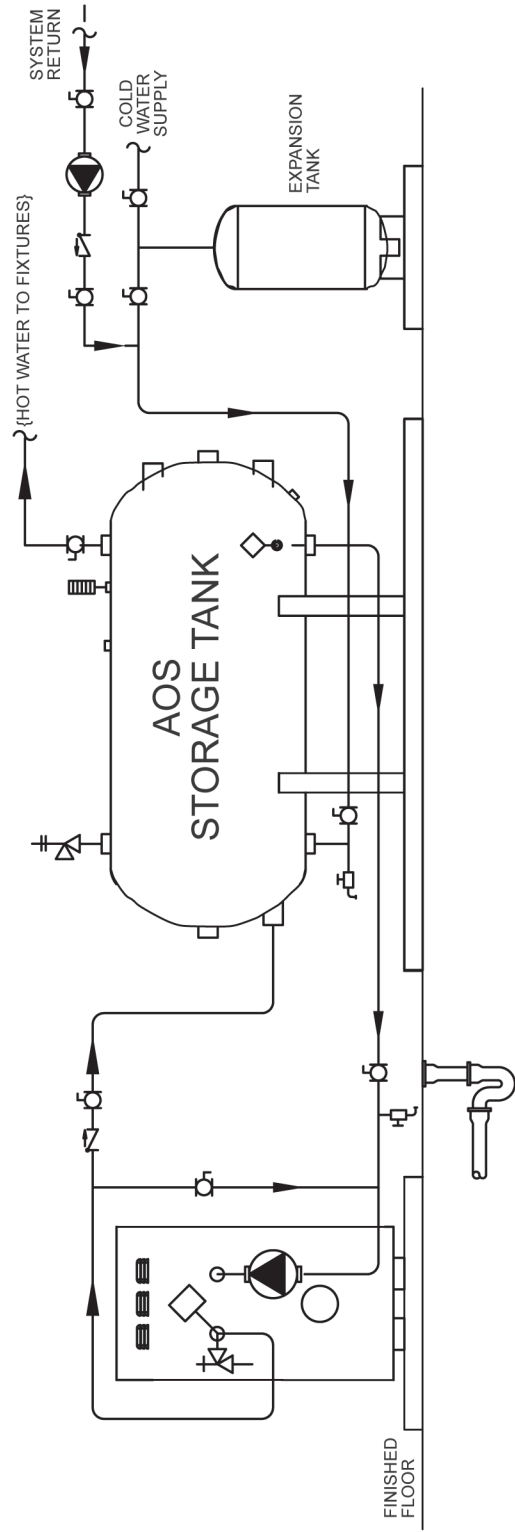

**! DANGER**  
 TEMPERATURE SETTING SHOULD NOT EXCEED SAFE USE TEMPERATURE AT FIXTURES. IF HIGHER PREHEAT TEMPERATURES ARE NECESSARY TO OBTAIN ADEQUATE BOOSTER OUTPUT, ADD AN ANTI-SCALD VALVE FOR HOT WATER SUPPLIED TO FIXTURES, SEE TABLE 8.

- NOTES:
1. Preferred piping layout.
  2. The temperature and pressure relief valve setting shall not exceed pressure rating of any component in the system.
  3. Service valves are shown for servicing boiler. However, local codes shall govern their usage.
  4. Maximum piping length between tank and boiler should not exceed a total of 50 equivalent feet constructed of 2 inch pipe size or larger.

FIGURE 15.

## WIRING

### CAUTION

- Label all wires prior to disconnection
- Strict adherence to the wiring diagrams is required
- When replacing wire, use type 105°C or its equivalent

Label all wires prior to disconnection when servicing controls. Wiring errors can cause improper and dangerous operation.

Verify proper operation after servicing. Strict adherence to the wiring diagrams is required to prevent constant pump operation when the system controller is satisfied. Otherwise the warranty is void as stipulated in the limited warranty in this installation manual.

If any of the original wire, as supplied with the appliance, must be replaced, it must be replaced with type 105°C wire or its equivalent.

### CAUTION

Using a multi-meter, check the following voltages at the circuit breaker panel prior to connecting any equipment. Make sure proper polarity is followed and house ground is proven. To eliminate the possibility of electrical interference to the boiler controls, this figure must be confirmed.

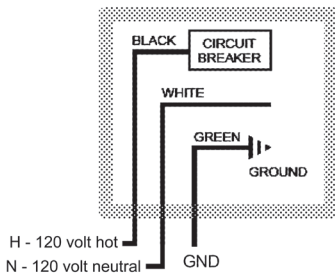

Confirm RMS voltage between:

Hot to gnd = 108 VAC Minimum, 132 VAC MAX  
Hot to neutral = 108 VAC Minimum, 132 VAC MAX  
Neutrally grd = <1 VAC Maximum

Verify that circuit breaker is properly sized by referring to heater rating plate. A dedicated circuit breaker should be provided.

Figure 16.

There are five (5) electrical connections that must be made for the unit to operate correctly:

1. BLACK (No Stripe) 120V HOT
2. WHITE 120V NEUTRAL
3. GREEN GROUND
4. (2) TANK PROBE OR (2) ENABLE/DISABLE\*\*\*

\*\*\* Enable/disable can also be used with a 24 volt thermostat. Do not use tank probe when using thermostat.

These connections shall be made at the rear of the unit where a junction box is provided. AN ELECTRICAL GROUND IS REQUIRED TO REDUCE THE RISK OF ELECTRIC SHOCK OR POSSIBLE ELECTROCUTION. A GROUND SCREW IS PROVIDED IN THIS JUNCTION BOX.

**NOTE: Tank probes are not provided on VB models, it is required that a system/operating temperature controller (field supplied) be installed to regulate loop or system temperatures. Two yellow wires are provided in the rear junction box for this connection. Do not operate this boiler without system or operating control.**

When operating the boiler with the tank probe the enable/disable must be wired together.

**Refer to the Connection Diagram, see Figure 17, and to the Schematic Diagram, see Figure 18.**

**TABLE 6. Suggested Pipe Size For Multiple Gas Appliances (Natural Gas).**

Nominal Iron Pipe Size (Inches)		Maximum Capacity of Pipe in BTU/hr and kW for Gas Pressures of 14 in. W.C. (0.5 psi) or Less and a Pressure Drop of 0.5 in. W.C. (based on 0.60 Specific Gravity Gas w/Heating Value of 1,000 BTU's/Ft3)													
		Length of Pipe in Feet (Meters)													
		10 (3.05)	20 (6.1)	30 (9.14)	40 (12.19)	50 (15.24)	60 (18.29)	70 (21.34)	80 (24.38)	90 (27.43)	100 (30.48)	125 (38.1)	150	175	200
1	BTU/hr kW	680,000 199	465,000 136	— —	— —	— —	— —	— —	— —	— —	— —	— —	— —	— —	— —
1 1/4	BTU/hr kW	1,400,000 410	950,000 278	770,000 226	660,000 193	580,000 170	530,000 155	490,000 144	460,000 135	— —	— —	— —	— —	— —	— —
1 1/2	BTU/hr kW	2,100,000 615	1,460,000 428	1,180,000 346	990,000 290	900,000 264	810,000 237	750,000 220	690,000 202	650,000 190	620,000 182	550,000 161	500,000 146	460,000 135	— —
2	BTU/hr kW	3,950,000 1,157	2,750,000 805	2,200,000 644	1,900,000 556	1,680,000 492	1,520,000 445	1,400,000 410	1,300,000 381	1,220,000 357	1,150,000 337	1,020,000 299	950,000 278	850,000 249	800,000 234
2 1/2	BTU/hr kW	6,300,000 1,845	4,350,000 1,274	3,520,000 1,031	3,000,000 879	2,650,000 776	2,400,000 703	2,250,000 659	2,050,000 600	1,950,000 571	1,850,000 542	1,650,000 483	1,500,000 439	1,370,000 401	1,280,000 375
3	BTU/hr kW	11,000,000 3,222	7,700,000 2,255	6,250,000 1,830	5,300,000 1,552	4,750,000 1,391	4,300,000 1,259	3,900,000 1,142	3,700,000 1,084	3,450,000 1,010	3,250,000 952	2,950,000 864	2,650,000 776	2,450,000 718	2,280,000 668
4	BTU/hr kW	23,000,000 6,736	15,800,000 4,627	12,800,000 3,749	10,900,000 3,192	9,700,000 2,841	8,800,000 2,577	8,100,000 2,372	7,500,000 2,197	7,000,000 2,109	6,700,000 1,962	6,000,000 1,757	5,500,000 1,611	5,000,000 1,464	4,600,000 1,347

**TABLE 7. Suggested Pipe Size For Multiple Gas Appliances (Propane Gas).**

Nominal Iron Pipe Size (Inches)		Maximum Capacity of Pipe in BTU/hr and kW for Gas Pressures of 14 in. W.C. (0.5 psi) or Less and a Pressure Drop of 0.5 in. W.C. (based on 0.60 Specific Gravity Gas w/Heating Value of 1,000 BTU's/Ft3)													
		Length of Pipe in Feet (Meters)													
		10 (3.05)	20 (6.1)	30 (9.14)	40 (12.19)	50 (15.24)	60 (18.29)	70 (21.34)	80 (24.38)	90 (27.43)	100 (30.48)	125 (38.1)	150	175	200
1	BTU/hr kW	1,060,800 311	725,400 212	585,000 171	499,200 146	— —	— —	— —	— —	— —	— —	— —	— —	— —	— —
1 1/4	BTU/hr kW	2,184,000 640	1,482,000 434	1,201,200 352	1,029,600 302	904,800 265	826,800 242	764,400 224	717,600 210	670,800 196	624,000 183	561,600 164	507,000 148	468,000 137	— —
1 1/2	BTU/hr kW	3,276,000 959	2,277,600 667	1,840,800 539	1,544,400 452	1,404,000 411	1,263,600 370	1,170,000 343	1,076,400 315	1,014,000 297	967,200 283	858,000 251	780,000 228	717,600 210	670,800 196
2	BTU/hr kW	6,162,000 1,805	4,290,000 1,256	3,432,000 1,005	2,964,000 868	2,620,800 768	2,371,200 694	2,184,000 640	2,028,000 594	1,903,200 557	1,794,000 525	1,591,200 466	1,482,000 434	1,326,000 388	1,248,000 366
2 1/2	BTU/hr kW	9,828,000 2,878	6,786,000 1,987	5,491,200 1,608	4,680,000 1,371	4,134,000 1,211	3,744,000 1,097	3,510,000 1,028	3,198,000 937	3,042,000 891	2,886,000 845	2,574,000 754	2,340,000 685	2,137,200 626	1,999,800 585
3	BTU/hr kW	17,160,000 5,026	12,012,000 3,518	9,750,000 2,856	8,268,000 2,421	7,410,000 2,170	6,708,000 1,965	6,084,000 1,782	5,772,000 1,690	5,382,000 1,576	5,070,000 1,485	4,602,000 1,348	4,134,000 1,211	3,822,000 1,119	3,556,800 1,042
4	BTU/hr kW	35,880,000 10,508	24,648,000 7,219	19,968,000 5,848	17,004,000 4,980	15,132,000 4,432	13,728,000 4,021	12,636,000 3,701	11,700,000 3,427	11,232,000 3,290	10,452,000 3,061	9,360,000 2,741	8,580,000 2,513	7,800,000 2,284	7,176,000 2,102

FIGURE 17. CONNECTION DIAGRAM

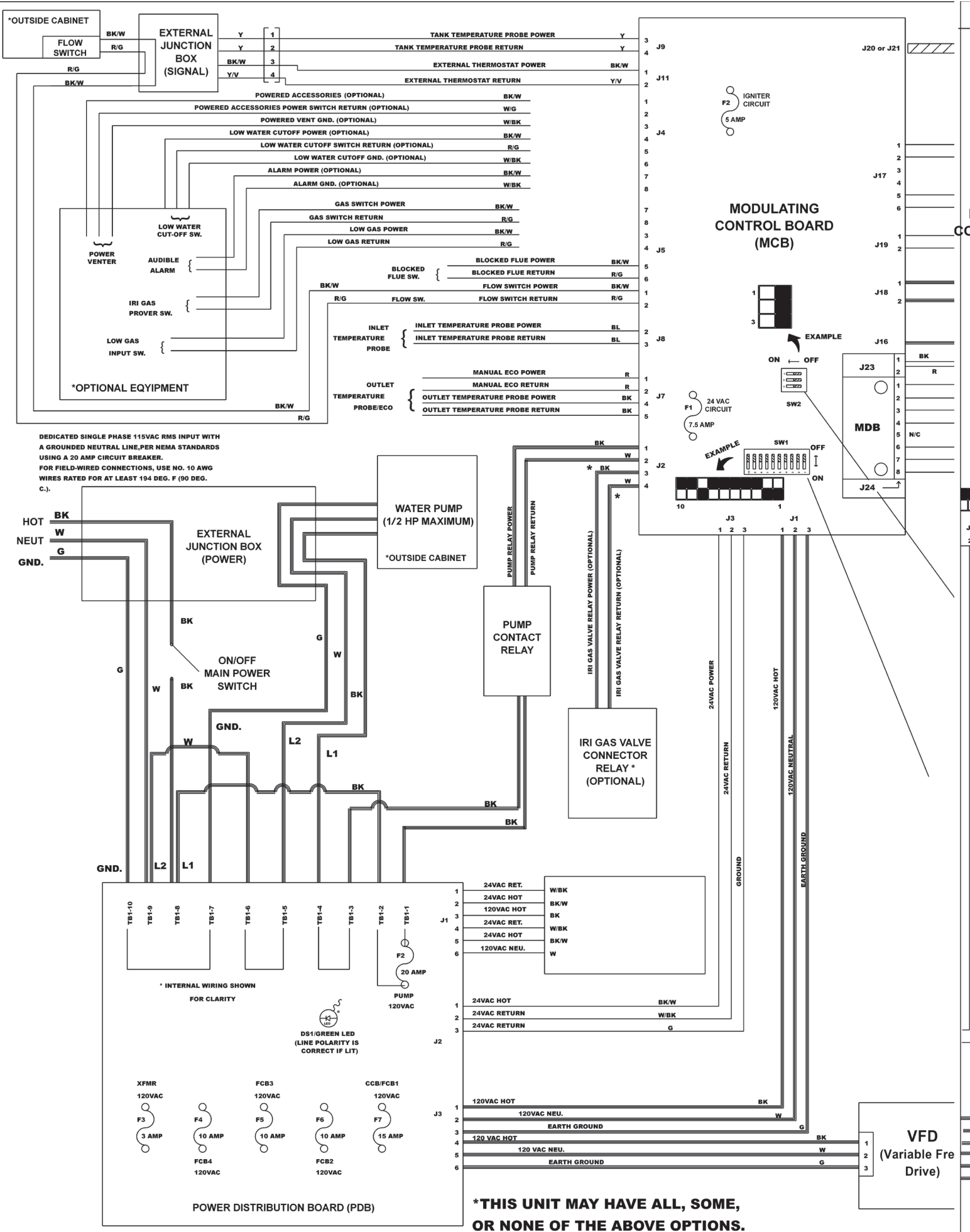

# VB/VW Variable Fire Wiring Diagram

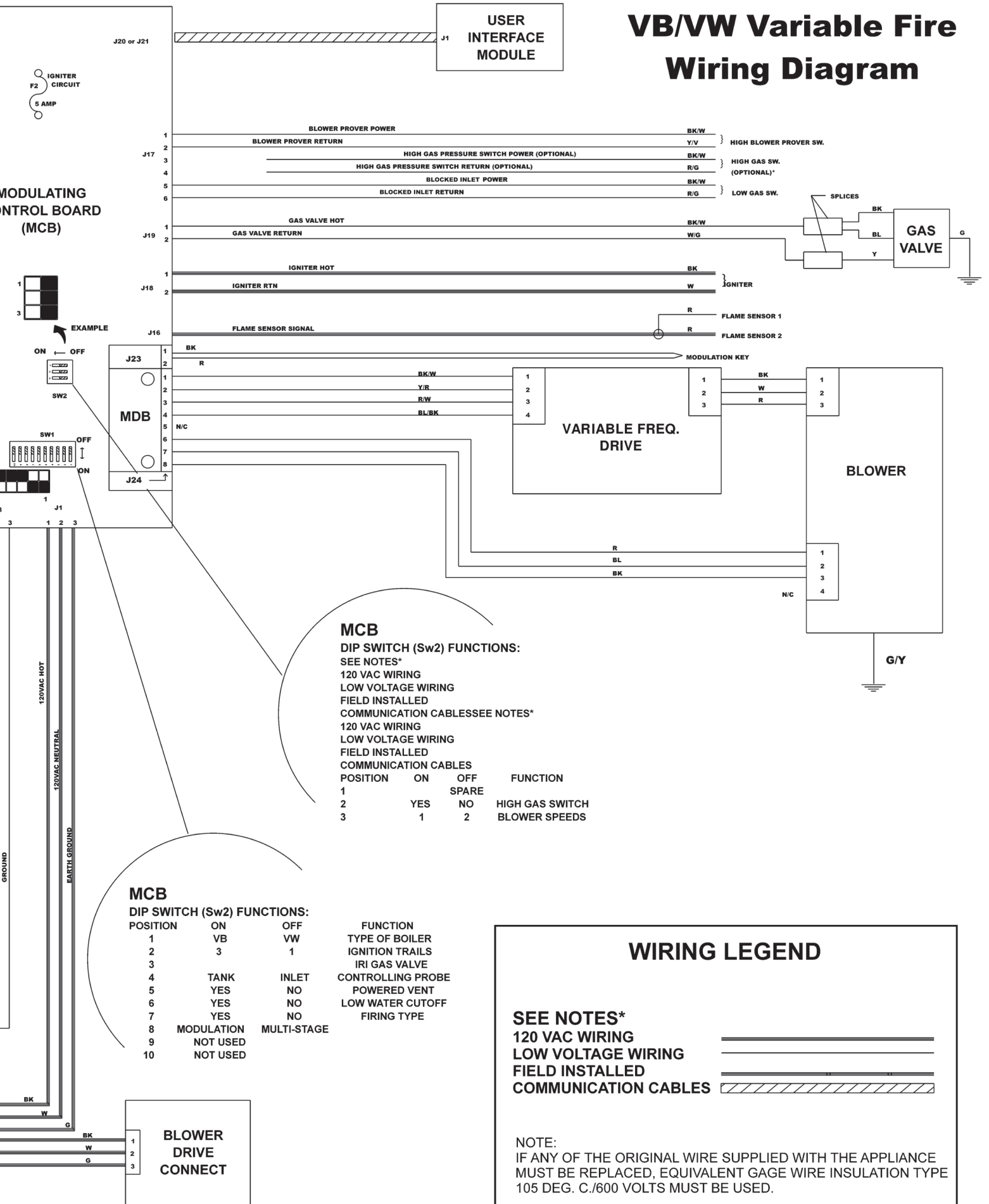

# VB/VW-500, 750 & 1000 SCHEMATIC DIAGRAM

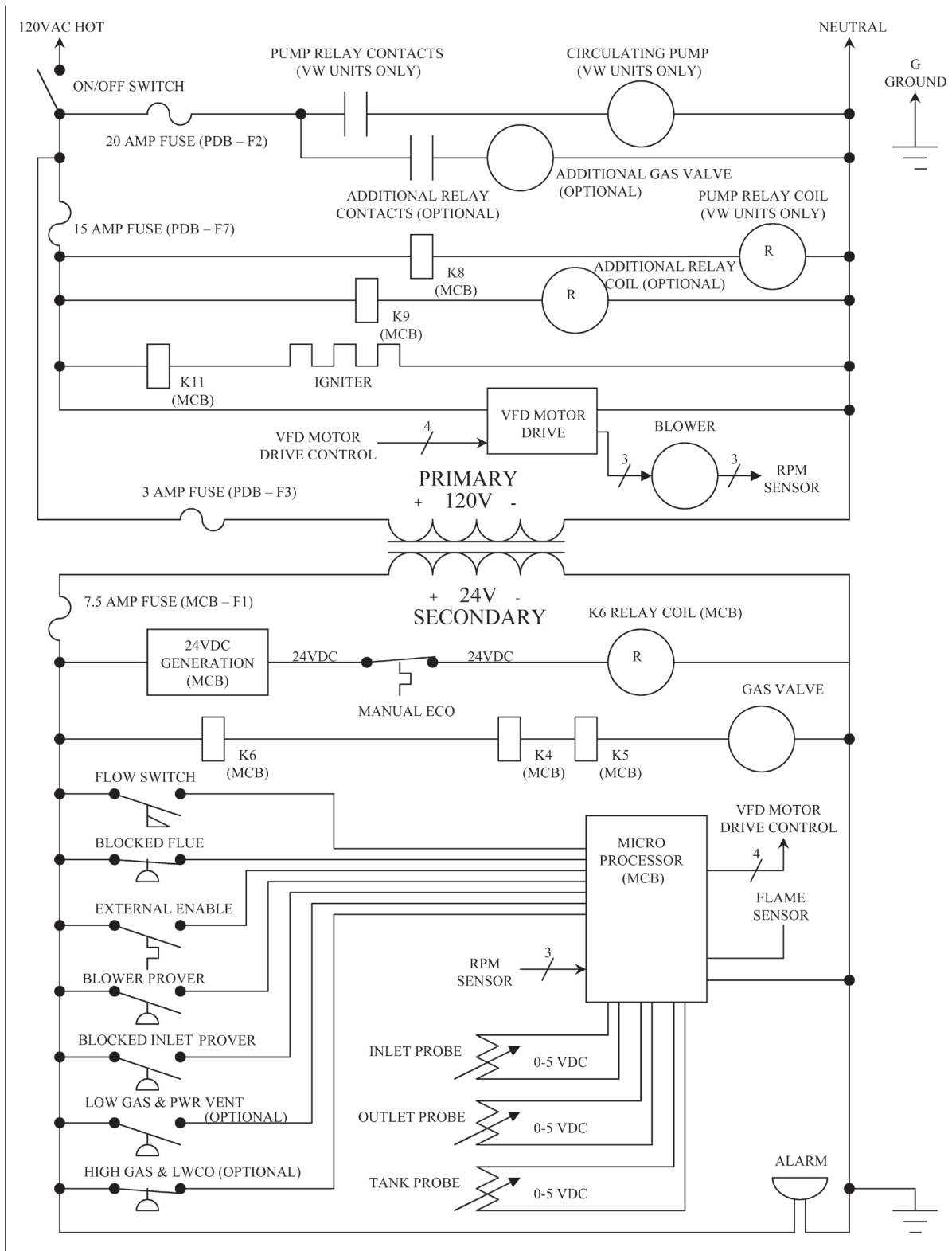

**FIGURE 18. - SCHEMATIC DIAGRAM**



# OPERATION

## IMPORTANT

Only qualified personnel shall perform the initial firing of the boiler. At this time the user should not hesitate to ask the service agent any questions regarding the operation and maintenance of the unit. If you still have questions, please contact the factory or your local A.O. Smith representative.

Lighting and Operating instructions are included with this manual. By using these instructions, the user may be able to make minor operational adjustments and save unnecessary service calls. However the user should not attempt repairs, but should contact a service technician or gas supplier.

## GENERAL

Never operate the boiler without first making sure the boiler and system are filled with water, in addition:

For hot water supply installations:

- Make sure a temperature and pressure relief valve is installed at the boiler and, if used, the storage tank. Also check for leaks.

For heating boiler installations:

- Make sure that the boiler and system have been purged of air and checked for leaks.

Also be sure to check the gas piping for leaks before beginning the initial firing of the boiler.

## FILLING AND PURGING OF HEATING BOILER INSTALLATION

1. Fast fill system through bypass until pressure approaches desired system pressure. Close bypass valve and permit pressure to be established by the pressure reducing valve.
2. Vent all high points in system to purge system of air.

Provisions should be made to permit manual venting of radiators or convectors.

## FILLING HOT WATER SUPPLY BOILER INSTALLATION

1. Close the system's drain valve by turning handle clockwise.
2. Open a nearby hot water faucet to permit the air to escape.
3. Fully open the cold water inlet pipe valve allowing the boiler and piping to be filled.
4. Close the hot water faucet as water starts to flow.
5. The boiler is ready to be operated.

## PURGING GAS LINE

Gas line purging is required with new piping or systems in which air has entered.

## CAUTION

Purging should be performed by persons experienced in this type of gas service to avoid risk of fire or explosion. Purge discharge must not enter confined areas or spaces where ignition can occur. The area must be well ventilated and all sources of ignition must be deactivated or removed.

Before placing the boiler in operation, check for gas leakage. Use a soap and water solution or other material acceptable for the purpose of locating gas leaks. Do not use matches, candles, flame or other sources of ignition for this purpose.

## WARNING

### Fire Explosion Hazard

The manual gas valve must be in the off position for at least five minutes. This waiting period is an important safety step to permit gas in the combustion chamber to clear.

If you detect gas odor at the end of the five minute period, do not proceed with lighting. Gas odor, even if it seems weak, may indicate the presence of accumulated gas in the area with risk of fire or explosion. See the front page of this manual for necessary steps.

## INLET GAS PRESSURE

The inlet gas pressure is measured by removing the 1/8" NPT Plug located on the main gas manifold which is upstream of the unit's gas valve, and insert a 1/8" NPT hose barb fitting to be connected to a manometer or pressure gauge. Once pressure has been checked and/or adjusted, replace the plug and check for leaks. The maximum value specified in the table must not be exceeded. The minimum values, shown in Table 1, must be maintained under both load and no load conditions (static and firing conditions). The combination gas valves supplied with the boiler are for low pressure service. **If upstream pressure exceeds 14.0" W.C., an intermediate gas pressure regulator of the lockup type must be installed.**

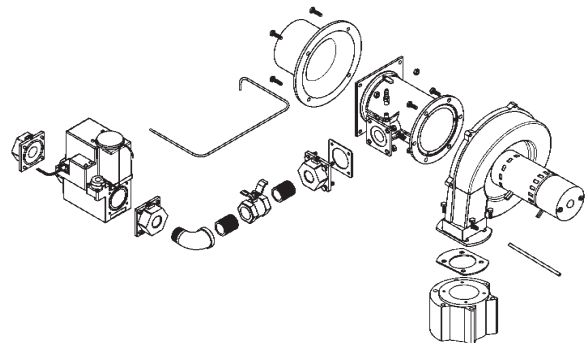

FIGURE 19. GAS TRAIN ASSEMBLY.

! **CAUTION**

**Gas Supply**

Should overheating occur or the gas supply fail to shut off, turn off the gas supply at a location external to the boiler (i.e., main manual gas shutoff valve).

Light the boiler in accordance with the instructions provided on the label affixed to the boiler's front door on the inside.

The boiler should be located in an area that is inaccessible to the general public.

Never allow small children to use a hot water tap or to draw their own bath water. Never leave a child or handicapped person unattended in a bathtub or shower.

**TABLE 8. Risk of Scalds.**

Water Temperature	Time to Produce 2nd & 3rd Degree Burns on Adult Skin
Over 170°F (77°C)	Nearly instantaneous
160°F (71°C)	About 1/2 second
150°F (66°C)	About 1-1/2 seconds
140°F (60°C)	Less than 5 seconds
130°F (54°C)	About 30 seconds
120°F (49°C) or less	More than 5 minutes

## WATER TEMPERATURE REGULATION

! **DANGER**

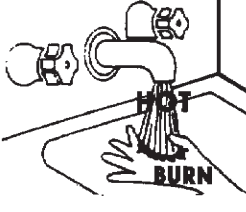

Untempered hot water can cause severe burns instantly resulting in severe injury or death.

Children, elderly, and the physically or mentally disabled are at highest risk for scald injury.

Feel water before bathing or showering. Temperature limiting valves are available.

Read instruction manual for safe temperature setting.

SHOULD OVERHEATING OCCUR OR THE GAS SUPPLY FAIL TO SHUT OFF, TURN OFF THE MAIN MANUAL GAS SHUTOFF VALVE TO THE APPLIANCE.

The operating temperature of the boiler must be maintained as follows:

- 120°F (49°C) or higher inlet water temperature to the boiler.
- 20°F (11°C) differential between the boiler's inlet and outlet (e.g. 120°F [49°C] inlet, 140°F [60°C] outlet minimum design temperatures).

If the inlet water temperature into the boiler is less than 120°F (49°C), adjustments on the water bypass and the outlet valves at the rear of the boiler, see Figures 14 and 15, are required; wait at least one minute between adjustments for the temperature to stabilize.

- 1) If necessary, throttle down (close) the water outlet gate/ball valve until the desired outlet water temperature (120°F [49°C] minimum) is reached. Wait one minute.
- 2) Note the outlet and inlet temperature indicator readings.
  - a) If the inlet water temperature is less than 120°F (49°C), open, in small increments, the bypass (balancing) valve until the minimum 120°F (49°C) inlet water temperature or 20°F (11°C) differential, whichever has the higher inlet temperature, is attained.
  - b) If the inlet water temperature is greater than 120°F (49°C) and the 20°F (11°C) differential is not present, close the bypass valve until the 20°F (11°C) differential is attained.

**NOTE: It may be necessary to make further adjustments on the outlet and bypass valves until the desired inlet and outlet water temperatures are reached.**

**HOT WATER CAN SCALD:** Boilers are intended to produce hot water. Water heated to a temperature which will satisfy space heating, clothes washing, dish washing and other sanitizing needs can scald and permanently injure you upon contact. Some people are more likely to be permanently injured by hot water than others. These include the elderly, children, the infirm or physically/mentally disabled. If anyone using hot water in your home fits into one of these groups or if there is a local code or state law requiring a specific temperature water at the hot water tap, then you must take special precautions. In addition to using the lowest possible temperature setting that satisfies your hot water needs, a means such as a mixing valve should be used at the hot water taps used by these people or at the hot water supply tank. Mixing valves are available at plumbing supply or hardware stores. Follow the manufacturer's instructions for installation of the valves. Before changing the thermostat setting on the hot water system controller, see Table 8.

**Hot water temperatures required for automatic dishwasher and laundry use can cause scald burns resulting in serious personal injury and/or death. The temperature at which injury occurs varies with the person's age and time of exposure. The slower response time of children, aged or disabled persons increases the hazards to them. Never allow small children to use a hot water tap, or to draw their own bath water. Never leave a child or disabled person unattended in a bathtub or shower.**

## MANIFOLD PRESSURE CONNECTIONS

Take the manifold pressure, refer to Table 1, by removing the pipe plug and inserting a suitable 1/8" NPT hose barb for connection to the manometer/pressure gauge. Upon completion of measurements and adjustments, remove the hose barb and replace the pipe plug. Check for gas leaks and insure all connections are gas tight, see Figure 19..

**MCB - Ten Position Dipswitch:**

Dipswitch configurations are READ ONLY ON POWER UP. These switches are only to be set at the factory or by authorized trained personnel! Once set the boiler will operate according to the chosen options. If a switch is changed, power must be cycled before the change will take effect. The status of all dipswitches can be observed on the system status screen on the UIM.

**TABLE 9. - MCB/FCB Dipswitches:**

Dipswitch Function	Switch Position	
	Hot Water Boilers	Hydronic Heating Boiler
Switch 1: Selection of the type of boiler application:	On = VB	Off = VW
Switch 2: Trials for ignition:	On = 3	Off = 1
Switch 3: IRI Gas Valve Not Available:		
Switch 4: Controlling Probe:	On = Tank (Remote)	Off = Inlet
Switch 5: Powered Venter:	On = Yes	Off = No
Switch 6: Low Water Cut Off: (LWCO)	On = Yes	Off = No
Switch 7: Low Gas Pressure	On = Yes	Off = No
Switch 8: Modulation:	On	

NOTE: If the unit powers up with the number of stages selected by dip switches exceeding the number of FCBs, the MCB will detect this condition and go into a hard lockout. **After changing the dipswitches, the power must be cycled off and back on to accept any changes.**

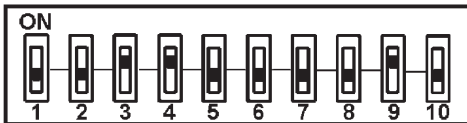

Example of Dipswitch configuration:

VB model, 1 ignition trial, not used, tank / remote probe, no power vent, No LWCO, no low gas pressure, modulation, not used, not used.

**MCB - Three position Dipswitch:**

This dipswitch is similar to the MCB dipswitches described above, but with only three switches being used: the number of blower speeds (switch #3), Hi Gas option (switch #2) and a spare (switch #1). Only the blower speed and Hi Gas options are the required selection, within the MCB, see Figure 17.

**TABLE 10.**

Dipswitch Function:	Dipswitch Position	
Switch 1: Spare:		
Switch 2: Hi Gas pressure switch:	On = Yes	Off = No
Switch 3: Number of Blower Speeds:	On = 1 speed,	Off = 2 speed

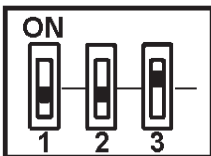

Example of Dipswitch configuration:  
No High Gas, 1 blower speed.

# LIGHTING & OPERATION INSTRUCTIONS FOR MODELS VB/VW 500, 750 AND 1000:

## FOR YOUR SAFETY READ BEFORE OPERATING



**WARNING: IF YOU DO NOT FOLLOW THESE INSTRUCTIONS EXACTLY, A FIRE OR EXPLOSION MAY RESULT CAUSING PROPERTY DAMAGE, PERSONAL INJURY OR LOSS OF LIFE.**



- A. THIS APPLIANCE DOES NOT HAVE A PILOT. IT IS EQUIPPED WITH AN IGNITION DEVICE WHICH AUTOMATICALLY LIGHTS THE BURNER. DO NOT TRY TO LIGHT THE BURNER BY HAND.
- B. BEFORE LIGHTING: SMELL ALL AROUND THE APPLIANCE AREA FOR GAS. BE SURE TO SMELL NEXT TO THE FLOOR BECAUSE SOME GAS IS HEAVIER THAN AIR AND WILL SETTLE ON THE FLOOR.
- WHAT TO DO IF YOU SMELL GAS
- DO NOT TRY TO LIGHT ANY APPLIANCE.
  - DO NOT TOUCH ANY ELECTRIC SWITCH;
  - DO NOT USE ANY PHONE IN YOUR BUILDING.
  - IMMEDIATELY CALL YOUR GAS SUPPLIER FROM A NEIGHBOR'S PHONE. FOLLOW THE GAS SUPPLIER'S INSTRUCTIONS.
  - IF YOU CAN NOT REACH YOUR GAS SUPPLIER, CALL THE FIRE DEPARTMENT.
- C. USE ONLY YOUR HAND TO TURN THE MAIN MANUAL GAS VALVE. NEVER USE TOOLS. IF THE KNOB WILL NOT PUSH IN OR TURN BY HAND, DON'T TRY TO REPAIR IT. CALL A QUALIFIED SERVICE TECHNICIAN. FORCE OR ATTEMPTED REPAIR MAY RESULT IN A FIRE OR EXPLOSION.
- D. DO NOT USE THIS APPLIANCE IF ANY PART HAS BEEN UNDER WATER. IMMEDIATELY CALL A QUALIFIED SERVICE TECHNICIAN TO INSPECT THE APPLIANCE AND TO REPLACE ANY PART OF THE CONTROL SYSTEM AND ANY GAS CONTROL WHICH HAS BEEN UNDER WATER.
- E. DO NOT OPERATE APPLIANCE UNLESS UNIT IS FILLED WITH WATER AND WATER LINES ARE FULLY OPEN.

GAS FLOW

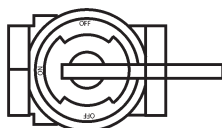

OPEN

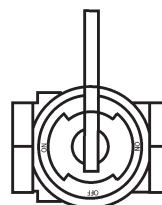

CLOSED

## OPERATING INSTRUCTIONS

1. STOP! READ THE SAFETY INFORMATION ABOVE ON THIS LABEL.
2. SET SYSTEM TEMPERATURE CONTROLLER TO LOWEST SETTING.
3. TURN OFF ELECTRIC POWER TO THE BOILER.
4. CLOSE MAIN VALVE. TURN MAIN MANUAL GAS VALVE TO "OFF" OR CLOSED POSITION. THE VALVE IS "OFF" WHEN THE HANDLE IS PERPENDICULAR TO THE GAS FLOW DIRECTION.
5. WAIT FIVE (5) MINUTES TO CLEAR OUT ANY GAS. THEN SMELL FOR GAS INCLUDING NEAR THE FLOOR. IF YOU SMELL GAS STOP! FOLLOW "B" IN THE SAFETY INFORMATION ABOVE ON THIS LABEL. IF YOU DO NOT SMELL GAS, GO TO THE NEXT STEP.
6. OPEN MAIN VALVE. TURN MAIN GAS VALVE TO "ON" OR OPEN POSITION. THE VALVE IS IN THE "ON" POSITION WHEN THE HANDLE IS PARALLEL TO THE GAS FLOW DIRECTION.
7. THIS APPLIANCE IS EQUIPPED WITH AN IGNITION DEVICE WHICH AUTOMATICALLY LIGHTS THE BURNER. DO NOT TRY TO LIGHT THE BURNER BY HAND.
8. TURN ON POWER TO THE APPLIANCE.
9. SET SYSTEM TEMPERATURE CONTROLLER TO DESIRED OPERATING TEMPERATURE.
10. IF THE APPLIANCE WILL NOT OPERATE, FOLLOW THE INSTRUCTIONS TO TURN OFF GAS TO APPLIANCE. CALL YOUR SERVICE TECHNICIAN OR GAS SUPPLIER.

## TO TURN OFF GAS TO APPLIANCE

- A. SET SYSTEM TEMPERATURE CONTROLLER TO LOWEST SETTING.
- B. TURN OFF ELECTRICAL POWER TO BOILER.
- C. CLOSE MAIN VALVE. TURN MAIN MANUAL GAS VALVE TO "OFF" OR CLOSED POSITION. THE VALVE IS IN THE "OFF" POSITION WHEN THE HANDLE IS PERPENDICULAR TO THE GAS FLOW DIRECTION.

## ADJUSTMENT

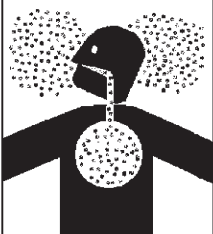
<b>⚠ WARNING</b>	
<b>Breathing Hazard - Carbon Monoxide Gas</b>	
	<p>Failure to make accurate adjustments could cause improper combustion resulting in death.</p>
<p>Breathing carbon monoxide can cause brain damage or death. Always read and understand instruction manual.</p>	

There must be sufficient load to operate the boiler at high fire to perform the following adjustments. Start the boiler and observe proper operating parameters for the system.

### Required Tools:

TORX® T40 or 5mm hex wrench

3mm or 7/64in hex wrench

Combustion analyzer

The VF 500, 750, and 1000 boilers are equipped with a Honeywell combined gas/air control and gas safety shut off control valves. The valve functions in parallel with the variable speed combustion blower to supply the correct gas air ratio for optimum performance and efficiency. The combustion blower speed is controlled automatically and determines the amount of negative pressure experienced by the gas safety shut off/control valves. The gas/air regulator adjusts gas flow to maintain the proper pressure at the outlet nozzle of the associated valve.

## SETTING OF THE TEST MODE

On UIM go to main menu, scroll down to user settings and press select. Scroll down to MOD mode, press select. Use the up and down keys to select options: MIN (MINIMUM FIRING RATE). MAX (MAXIMUM FIRING RATE). MOD (FOR AUTOMATIC MODULATION MODE). Press select for the desired option. For checking the combustion setup on MIN or MAX the boiler will remain in this state for ten minutes before defaulting to the MOD (modulation) mode.

TABLE 11. - HIGH FIRE SETTING

<b>NATURAL GAS</b>	<b>8.5 - 9.0% CO<sub>2</sub></b>
<b>PROPANE</b>	<b>9.5 - 10.5% CO<sub>2</sub></b>

Set boiler to the "Test Mode High," as described above, to achieve maximum firing rate of the boiler. Check combustion readings using a combustion analyzer. If combustion readings are not in accordance with the chart above adjust as follows: remove the flat, round, blue plastic cap from the cover. Using a 3mm (7/64") hex wrench, turn the adjustment screw counterclockwise to increase or clockwise to decrease gas flow and achieve the desired CO<sub>2</sub> level. See Table referenced above for correct settings. There will be a slight time delay between the adjustment and the response of the CO<sub>2</sub> measuring instrument. Adjust the settings in small increments and allow the combustion readings to stabilize before readjusting. When desired adjustments are complete, reinstall the blue plastic cap on the cover. Combustion samples shall be taken within two feet of the boiler. **IMPROPER ADJUSTMENT CAN CAUSE INCOMPLETE COMBUSTION RESULTING IN DEATH.**

TABLE 12. - LOW FIRE SETTING

<b>NATURAL</b>	<b>6.5 - 7.5% CO<sub>2</sub></b>
<b>PROPANE</b>	<b>7.5 - 8.5% CO<sub>2</sub></b>

Set boiler to the "Test Mode Low," as described above, to achieve minimum firing rate of the boiler. Check combustion readings using a combustion analyzer. If combustion readings are not in accordance with the chart shown above adjust as follows: remove the cap on the gas regulator using a slotted screwdriver. This will expose the offset adjustment screw. Using a TORX® T40 or a 5mm hex wrench, carefully adjust the low fire gas setting to achieve the CO<sub>2</sub> level prescribed in above reference table. **Note: The rotation of the Low Fire adjustment is opposite of the High Fire as follows: Clockwise rotation increases gas flow, counterclockwise rotation decreases gas flow.**

Adjustments to the offset pressure regulators should not exceed 1/4 turn at a time before allowing the readings to respond and stabilize.

After proper low fire offset adjustment is made, reinstall the slotted cap on the regulator.

Following all gas valve adjustments, check for proper light-off and verify correct fuel/air mix and combustion quality throughout the entire firing range (from lowest to highest fan speed).

## CONTROL SYSTEM

The EMC modulation control system is a fully integrated, state of the art electronic control system. It consists of sensors, output devices, a power switch, a 24VAC transformer, wiring, and the following printed circuit boards:

- Modulation Control Board (MCB), see Figure 2.
- Power Distribution Board (PDB), see Figure 2.
- User Interface Module (UIM), see Figure 20.

The MCB contains circuitry for both master control and flame control. Dip switches on the MCB are used to configure the system. The User Interface Module (UIM) communicates with the user through a set of touch pads and a 4-line, 20-character LCD display. The PDB provides connection points for input power, the water pump, and the transformer. It also distributes power to the system and contains the system fuses.

The MCB also contains an external communications system to allow for connection to a PC, a modem, an EMS system, or something similar. Through this connection, multiple boilers can also be linked together. **CAUTION: The internal communications cables should never be connected to the external communications connectors, and vice-versa.**

There are several microcontrollers used on the boards. These control the temperature and ignition control functions for the boiler. Inherent in the design are the normal operating sequences and safety features associated with a gas ignition control system. The system continuously performs various diagnostic tests to verify proper appliance and control operation. Should an unsafe condition occur, the control will shut down the burner and display a red service light as well as indicate the cause of the error on the display. The operating programs for the system are stored in permanent memory inside the microcontrollers. User-selectable operating parameters and a history of detected faults are stored in rewritable memory in the microcontrollers. A loss of power does not affect either of the memories.

## INPUTS TO MCB

### TEMPERATURE SENSORS:

**Temperature probes** (MCB - outlet and either inlet or tank are required): The MCB accepts analog temperature inputs from up to three sensors (inlet, outlet, and tank).

**MRHL** (Manual Reset HIGH LIMIT): The MRHL is a hi-limit switch located inside the outlet probe. It is a normally closed switch that opens if the probe is exposed to a temperature higher than the trip point. Once tripped, the control system needs to be manually reset.

**Thermostat input** (MCB - optional): This input is set up to work with an externally connected thermostat that provides a contact closure. If this input is closed and everything else is in the proper state, a "call for heat" condition will be initiated. These leads should be shorted together when a thermostat is not being used. If it is desired that the thermostat control the temperature of the boiler, the operating setpoint of the system should be set higher than the temperature that the thermostat is controlling. This will allow the thermostat to control the boiler. When the thermostat closes, a call for heat will be generated until the thermostat determines that the required temperature has been reached.

### AIR PRESSURE SENSORS (OPEN CONDITION INDICATES FAULT):

**Blocked Inlet** (MCB - required) Normally closed switch that activates if the air inlet is blocked 3/4 or more during operation.

**Blocked Flue** (MCB - required): Normally closed switch that opens if the flue becomes blocked during operation.

**Blower Prover** (MCB - required): Normally open switch that closes when the air pressure produced by the blower is above the set point.

### GAS PRESSURE SENSORS (OPEN CONDITION INDICATES FAULT):

**Low Gas** (MCB - required): Normally open switch that closes when the gas pressure rises above the trip level. This input is enabled/disabled by a dip switch on the MCB

**Hi Gas** (MCB - required): Normally closed switch that opens if the gas pressure exceeds a set value. This input is enabled/disabled by a dip switch on the MCB.

### WATER LEVEL SENSOR (OPEN CONDITION INDICATES FAULT):

**Low Water Cut Off** (MCB - optional): Normally open switch that closes when water reaches preset level. This input is enabled/disabled by a dip switch on the MCB.

### WATER FLOW SENSOR:

**Flow** (MCB - required): Normally open switch that closes when flow exceeds a set value.

### FLAME SENSOR:

**Flame** (MCB - required): Returns a signal to the microprocessor if flame is detected on the burner. If the flame rod is missing or shorted, the flame will not be detected.

### OUTPUTS FROM MCB

#### RELAY CONTACT OUTPUT:

**Alarm** (MCB - 24VAC - optional): Provides electrical power to operate an external alarm. This can be an audio device (i.e., Sonalert), a visual device (lamp), or any other device that will operate with the voltage and current level provided.

**Pump** (MCB - 120VAC - required on systems that do not have an external pump): Provides electrical power to directly operate a pump or the coil of an externally connected contactor.

**Blower** (MCB - 120VAC - required): Variable speed blowers utilize the high blower output only.

**Igniter** (MCB - 120VAC - required): Provides power to operate the HSI igniters.

**Gas Valve** (MCB - 24VAC - required): Provides power to activate the gas valve. The gas valve cannot be activated when the MRHL contacts are open.

**Low Water Cut Off** (MCB - 24VAC - optional): Directly connected to the 24VAC line to provide power to operate an external LWCO device.

### MCB AND PDB INDICATOR LAMPS AND FUSES

A green LED is mounted on the PDB to indicate when line voltage is applied (the PDB also contains a yellow and red LED, and a test/run jumper that are used during installation to verify proper power connections). A red LED on the MCB is used to indicate when the 24VAC input fuse has blown.

Yellow LEDs are located near the microcontrollers on the MCB. These LEDs are "heartbeat indicators," and blink approximately twice per second to indicate that the microcontrollers are running.

### MCB JUMPERS

The MCB has two jumpers. JP1 on the MCB is used to terminate the external communications line. It is normally left off and installed when the external cable is very long.

### IGNITERS

The EMC modulation system operates with Silicon Carbide Igniters

### MCB - Ten Position Dipswitch:

Dipswitch configurations are READ ONLY ON POWER UP. These switches are only to be set at the factory or by authorized trained personnel! Once set the boiler will operate according to the chosen options. If a switch is changed, power must be cycled before the change will take effect. The status of all dipswitches can be observed on the system status screen on the UIM.

**TABLE 13. - MCB/FCB Dipswitches:**

Dipswitch Function	Switch Position	
	Hot Water Boilers	Hydronic Heating Boiler
Switch 1: Selection of the type of boiler application:	On = VW	Off = VB
Switch 2: Trials for ignition:	On = 3	Off = 1
Switch 3: IRI Gas Valve Not Available:		
Switch 4: Controlling Probe:	On = Tank (Remote)	Off = Inlet
Switch 5: Powered Venter:	On = Yes	Off = No
Switch 6: Low Water Cut Off: (LWCO)	On = Yes	Off = No
Switch 7: Low Gas Pressure	On = Yes	Off = No
Switch 8: Modulation:	On	

NOTE: If the unit powers up with the number of stages selected by dip switches exceeding the number of FCBs, the MCB will detect this condition and go into a hard lockout. **After changing the dipswitches, the power must be cycled off and back on to accept any changes.**

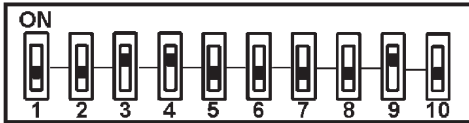

Example of Dipswitch configuration:

VB model, 1ignition trial, not used, tank / remote probe, no power vent, No LWCO, no low gas pressure, modulation, not used, not used.

**MCB - Three position Dipswitch:**

This dipswitch is similar to the MCB dipswitches described above, but with only three switches being used: the number of blower speeds (switch #3), Hi Gas option (switch #2) and a spare (switch #1). Only the blower speed and Hi Gas options are the required selection, within the MCB, see Figure 17.

**TABLE 14.**

Dipswitch Function:	Dipswitch Position	
Switch 1: Spare:		
Switch 2: Hi Gas pressure switch:	On = Yes	Off = No
Switch 3: Number of Blower Speeds:	On = 1 speed,	Off = 2 speed

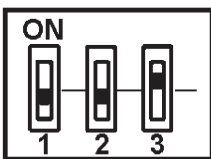

Example of Dipswitch configuration:  
No High Gas, 1 blower speed..

**OPERATING SEQUENCE**

1. The EMC modulation controller has four modes of operation: Initialization, Standby, Running/Modulation, and Service. The internal MCB micro control these modes through a sequence of steps (or States) which are further described in the "UIM Operating Procedures" section.
2. When power is applied to the system, it enters the initialization mode and the following automatic functions are performed:
  - A. O. Smith opening screen is displayed.
  - The system goes through a calibration indicated by the green running LED blinking and then staying on; next the red service LED and yellow standby LEDs come on, next the service and runnings LEDs blink ON and OFF.
  - Stored values are recalled from memory.
  - Configuration dipswitches are read.
  - Pending faults are recalled
  - Micros on all boards start running (indicated by a flashing Yellow LED near each micro)
  - Input sensors are read
3. After initialization is complete (approximately 10 seconds) the system turns the green LED off and goes to the standby mode (yellow "Standby" LED on), unless a previously stored fault has been recalled, which will send the system into the service model (red "Service" LED on). In standby mode the display shows the temperature screen and in fault mode the current error screen is displayed.
4. The system then compares the temperature read from the controlling probe (inlet or tank) to the setpoint temperature. If the temperature is less than the operating setpoint minus the differential temperature and the thermostat input is closed then a call for heat is established and the system shifts to the run mode (green "Running" LED turns on).
5. The heating sequence begins by applying power to the pump.

6. After a few seconds the blower is turned on for 30-second pre-purge period of combustion chamber.
7. The igniter is turned on.
8. After the igniter has reached a minimum of 2.8 amps, the gas valve is energized to allow gas flow to burner.
9. After an additional one second, the system checks the status of the flame through the flame sensor. If the flame is not verified within 4 seconds, the gas valve is immediately shut off followed by 15-second inter-purge period, then the system returns to step 7, if the "Trial for Ignition" dipswitch is set for three (3) tries. If the dipswitch is set for one (1) trial, the system will declare an error and boiler will require resetting the control.
10. The boiler will remain running until the set point is satisfied. Once satisfied, the blower will continue for 15-second post purge period.
11. Once set point has have been satisfied, the boiler pump will continue to run for the programmed post-circulate cycle.
12. The control now enters the idle state as displayed by the "Standby" LED. The control will continue to monitor heat demand and state of other system devices. Upon a drop of water temperature below the set parameters, the control will return to step 5 and repeat the entire operating cycle. Note: Any fault detection, during standby or running modes, will halt the heating sequence and shift the system to the service mode where the detected fault will be displayed.

NOTE: In standby and running modes the system constantly monitors the signals and the internal operation for faults. Any detected fault will halt the heating sequence and shift the system to the service mode, where the detected fault will be displayed.

**TEMPERATURE SETPOINTS (SYSTEM CONTROL ALGORITHM)**

The boiler has a hysteresis type control, which means that it will begin heating the water when the temperature sensed by the control probe (inlet or tank) falls below the operating setpoint minus the differential setpoint. It will stop heating the water when the temperature rises to the operating setpoint.

## UIM OPERATING PROCEDURES

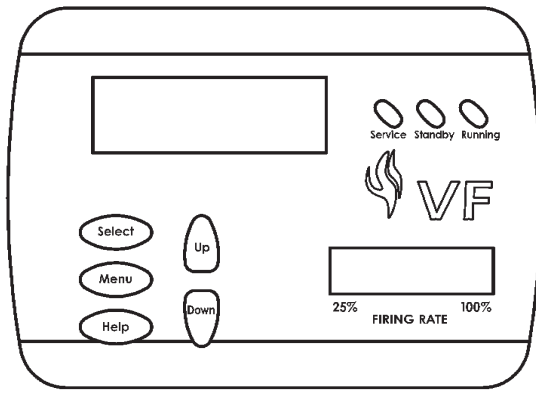

**FIGURE 20. UIM, USER INTERFACE MODULE**

The UIM receives commands from the user and displays operational information to the user via an LCD (liquid crystal display) up to eleven LED's, and five touch switches. The LCD provides information to the user by the use of 10 menu-activated screens. Within each of the screens, helpful information can be displayed by pressing the "Help" button. The LED's visually inform the user about the mode the system is in. The touch switches allow the user to control the operation of the system. The operation of these parts is described in the following section:

### UIM Screens:

On all screens a double vertical bar appears on the right side of the display each time a key is touched to indicate that a key has been activated. On several screens an indicator ">" appears on the left side of the display to indicate the active line. The "Up/Down" keys are used to move the indicator to the desired line and the "Select" key is pressed to select the line. Also, on most of the screens, up/down arrows appear on the right side of the screen to indicate that there is additional lines either above or below the displayed four lines.

- **Menu Screen:**

Displayed when the user presses the "Menu" key. This screen is the selection point for the other 9 screens.

- **Temperature Screen:**

Displays the sensed temperatures of the Outlet, Inlet, and Tank probes. Also displayed is the calculated Delta T (Outlet minus Inlet) for the system. Shorted ("Short") and disconnected ("----") probes are also displayed.

- **System Status Screen:**

This screen is used to view the status of switch inputs and output states. An asterisk (\*) is displayed next to the label when the status is "True" (the description is fulfilled). For example, if water is flowing, or detected by the flow sensor, then an "\*" will appear in front of the Flow label (i.e. \*Flow). Another example would be the ECO switch. If the outlet temperature is too high the display will show: \*ECO.

The System monitors the inputs of these times:

- MRHL, Blocked Inlet, Blocked Flue, Low Gas, Hi Limit, and Hi Gas - at all times for a fault condition.
- Tstat - at all times for open/closed conditions.
- Flow-for an on condition when the pump is on (no check for off state)
- Blower Prover - when the Blower is on.
- Igniter Current - for an on condition approximately 18 seconds

after the Igniter is turned on until the igniter is turned off and an off condition at all other times.

- Flame - for an on condition approximately 5 seconds after the gas valve is turned on until the valve is turned off and at all other times for an off condition.

### Control Status Screen:

Displays the status that the MCB micros are in. The MCB has 5 possible states and the FCB have 9. The normal MCB states sequence is to move from Idle to Pre-Circulate when a call for heat is initiated. Once heat has been satisfied or the Thermostat is opened, the sequence moves to Post-Circulate and then back to Idle. If a fault occurs at any time, the process jumps out of sequence and goes directly to the appropriate Hard or Soft Fault state.

### Description of MCB control states:

- Idle:

The yellow "Standby" LED is turned on and the system waits for a heat request (determined by the Thermostat or controlling probe inputs). All outputs are off in this state except that if the Post-Circulate time is set to continuous, the pump will be on. When the heat request is received, the system moves to the Pre-Circulate state.

- Pre-Circulate:

The yellow LED is turned off and the green "Running" LED is turned on. The green LED will remain on for all other states except the fault states. Cold purging clears out any combustion gas that may be in the combustion chamber. When purging is complete the system moves to the Heat State.

- Heat Stage

The system will command the FCB micros to start their heat sequence. will be activated in order based on an algorithm that determines how much heat is needed. The system will remain in this state until the heat request is satisfied, the Tstat is opened, or a fault occurs.

- Soft Fault State: (See "Fault Description" section for list of soft and Auto Reset faults.)

The pump remains on for the selected post-circulate time to cycle the hot water out of the boiler. The FCB is commanded to shut down and the Alarm output is turned on. The green LED turns off and the red "Service" turns on. The MCB remains in this state until one of the following occurs:

- One hour passes (automatic restart after one hour)
- If Communications error system will automatically restart if communications re-establishes.
- If user presses Select key while current error screen is displayed (Hard reset).
- If high-limit error - the outlet temperature drops below the high limit trip point minus the high limit differential. (outlet water temperature drops to safe level). The fault is logged in the error history when the fault state is exited.
- Hard Fault State: (See "Fault Description" section for list of soft and Auto Reset faults.) The pump remains on for the selected post-circulate time to cycle the hot water out of the boiler. The FCB is commanded to shut down and the Alarm output is turned on. The green LED turns off and the red "Service" turns on and off (flashes). The only way to exit this state is for the user to press the Select key while the current error screen is displayed. The fault is logged in the error history when the fault state is exited.

While the MCB is in the Heating mode the FCB moves from Idle, to Pre-Purge, to Heat Igniter, to Check for Flame, and then to Heating.



The process waits in this state until the call for heat is satisfied, the thermostat input is opened, or a fault occurs. When heat is satisfied, the sequence continues to Post-Purge and then back to Idle. If three tries for ignition has been selected on the MCB dipswitch and flame is not detected at the appropriate time, then the sequence moves to the Inter-Purge state for 15 seconds and the FCB heat sequence is repeated. If flame is still not detected after the third try the process declares a fault, jumps out of sequence and goes to the error state. Other types of faults detected at any time will also cause a jump to the error state.

#### Description of FCB control states:

- **Idle State:**

When any error is declared during idle state-The system will remain in this state until the MCB request a heating cycle, or a cold purge.
- **Pre-Purge State:**

The blower is turned on. After 10 to 34 seconds (34 seconds for cold purging) the system switches to the Heat Igniter State.
- **Heat Igniter State:**

The sequence of operation is as follows: "The igniter relay is energized and the heat up period begins. After 18-20 seconds, if the igniter has reached a minimum of 2.8 amps, the gas valve safety circuit is then activated. If in this amount of time, the igniter fails to reach a minimum amp draw of 2.8 amps, the unit will re-cycle up to 3 times before locking out on igniter hardware failure. If the igniter does reach the minimum required amp draw of 2.8 amps, the gas valve circuit is energized, and the system advances to Flame Check status.
- **Check for Flame State:**

The gas valve is turned on. After 1.5 seconds, the system checks that the gas valve relay is on. If it is not, the ignition trial is considered to have failed and the system advances to the Inter-Purge state, if any ignition trials remain, otherwise an error is declared.

The flame sensor is checked. If flame is detected, the igniter is turned off. The state machine then advances to the Heating State. If after 5 seconds, the flame is still not sensed then the ignition trial is considered to have failed. The state machine advances to Inter-Purge if any ignition trials remain, otherwise an error is declared.
- **Heating State:**

The system remains in this state until the call for heat is cancelled or a fault occurs. The system returns to the Idle state if the call for heat is cancelled, or satisfied and to the appropriate fault state if a fault occur.
- **Inter-Purge State:**

The gas valve and the igniter are turned off. The blower is on. After approximately 15 seconds the system goes back to the Heating Igniter State.
- **Post-Purge State**

The gas valve and the igniter are turned off. If this stage does not have a blower the system returns to the idle state. If it does have a blower then the blower is left on. After approximately 25 seconds, the system returns to the Idle state.
- **Error State**

The gas valve and the igniter are turned off. The FCB micro tells the MCB micro which error has occurred. The system waits in this state until the MCB sends a command to clear the error, and the system returns to the idle state.

- **Cold Purge State**

Cold purge occurs when the MCB micro commands the blower to go on before lighting to clear the unit of residual gases. This state normally lasts approximately 32 seconds but on a special situation can last up to 5 minutes. If on the first call for heat after power up, blower prover switch is open, this state will take up to 5 minutes before declaring an error.

The MCB will wait the normal cold purge time (normally 32 seconds) before checking for activation of all active blower prover. If blower prover is active at this time the MCB cancels the cold purge request. After the first cold purge has been done a flag is set to prevent further activation of the shutter adjust 5 minute delay. Any further requests for cold purge will last the normal cold purge time. The FCB will go into fault mode if the blower prover does not activate after 15 seconds. This time allows the blower relay to activate, the blower to come up to speed, and the response from the blower prover to be filtered.

- **User Settings Screen:**

Each setpoint or user setting has either a limited selection of values, or a limited range of values. The Up/Down keys are used to change values. After changing an item, the Select key is pressed to accept the change, or the Menu key is pressed to reject the change and restore the item to its original value. The following setpoints can be changed:

- **Operating Setpoint:**

This setpoint sets the base temperature for the control algorithm.

### OPERATING SETPOINT ADJUSTMENT PROCEDURE

The system has a standard programmable Operating Setpoint range of 70°F (21°C) to 190°F (88°C) for a VW and of 70°F (21°C) to 220°F (104°C) for a VB for either a Remote or inlet probe depending on selection. The user can easily change the Operating Setpoint at any time by using the following procedure. When any configuration or setpoint is changed (and the Select key touched), the new value is IMMEDIATELY saved to non-volatile memory. The factory default setting is 120°F (49°C).

1. Press the MENU key.
2. Scroll the ">" with the DOWN key next to the USER SETTING SCREEN.
3. Press the SELECT key.
4. Scroll the ">" with the DOWN key until it is pointing to OPERATING SETPOINT.
5. Press the SELECT key.
6. Use the UP or DOWN key to select the value you wish to enter.
7. Press the SELECT key to accept and store the new value.

- **High Limit:**

The outlet temperature probe contains both an ECO switch and a thermistor for temperature measurement. The sensed outlet temperature is used for the automatically resettable High Limit setpoint. If the sensed outlet temperature exceeds the High Limit setpoint, a "soft lockout" condition will occur and the burner will be shut off. This fault condition is automatically cleared when the temperature drops below the high limit setpoint minus the high limit differential.

### AUTO HIGH LIMIT SETPOINT ADJUSTMENT PROCEDURE/ OUTLET TEMPERATURE PROBE

The High Limit setpoint has a range of 90°F (32°C) to 210°F (99°C) for a VW and a range of 90° (32°C) to 235°F (113°C) for a VB.

Use the following procedure to change the automatically resettable High Limit Setpoint:

1. Press the MENU key.
2. Scroll the ">" with the DOWN key next to USER SETTING SCREEN.
3. Press the SELECT key.
4. Scroll the ">" with the DOWN key until it is pointing to HIGH LIMIT SETPOINT.
5. Press the SELECT KEY.
6. Use the UP and DOWN key to select the value you wish to enter.
7. Press the SELECT key to accept and store the new value.

- **High Limit Differential:**

The outlet temperature must be below the automatic High Limit setpoint minus the High Limit Differential setpoint before a call for heat can be generated.

## HIGH LIMIT DIFFERENTIAL SETPOINT ADJUSTMENT PROCEDURE

The High Limit Differential Setpoint has a range of 1°F to 50°F for all models. Use the following procedure to change the High Limit Differential Setpoint:

1. Press the MENU key.
2. Scroll the ">" with the down key next to USER SETTING SCREEN.
3. Press the SELECT key.
4. Scroll the ">" with the DOWN key until it is pointing to HIGH LIMIT DIFFERENTIAL SETPOINT.
5. Press the SELECT key.
6. Use the UP or DOWN key to select the value you wish to enter.
7. Press the SELECT key to accept and store the new value.

- **Operating Differential Setpoints:**

Each of the two stages has an independent Operating Differential setpoint.

- **Temperature Units:**

Temperature can be displayed in either °F or °C units.

- **Post Circulate Delay Time:**

The time circulation pump will stay on after the burner is turned off. The time in seconds is adjustable with the following values: 45, 90, 180 or continuous. If the continuous value is selected the pump will remain on at all times and the post circulate state time will be set at 45 seconds.

- **Network Address:**

This is a unique number assigned to this boiler to differentiate it from other boilers or water heater on the same A. O. Smith proprietary network. A valid Network Address can be any number from 1 to 31. It is set by default to zero, which is an invalid address. The boiler will not communicate until it is changed to a valid and unique number. This prevents two units from trying to respond to the same request from the PC or supervisory network device.

- **Configuration Settings Screen:**

Displays the status of the dipswitches installed on all boards as described earlier.

- **Log & System Info Screen:**

Displays the following information:

Elapsed hours of operation (Total time system has been powered up)

Number of running minutes (Number of minutes system has been in the run mode)

kBtu rating of the boiler (0 to 5750kBtu in 10kBtu increments)

The software revision level of the MCB.

- **Current Error Screen:**

Displays the last error that the system has detected plus a time stamp of when the error occurred. (The time stamp is based on the elapsed hours value at the time the error occurred. It is displayed in hours and minutes. This error remain displayed as long as it is still valid. When cleared it is moved to the Error History Screen. The system will automatically jump to this screen when an error is detected. It will also go to this screen upon power-up if an error was still valid when power was turned off.

**NOTE: Errors are cleared from this screen by pressing the "select" key.**

- **Error History Screen:**

This screen displays a list of the last 9 errors (with time stamps) that have occurred. The last error to occur is displayed first. If a new error occurs this screen is presented to display the error.

- **Reload Defaults Screen:**

From this screen the user can restore the factory default values for screen adjustable configurations by pressing the Select key. The values restored are as follows:

VW Models

Oper Setpnt (Operating Setpoint) - 145° F (63° C)

Hi Limit (High Limit Setpoint) = 210° F (99° C)

Hi Limit Dif (High Limit Differential) = 20° F (11° C)

VB Models

Oper Setpnt (Operating Setpoint) = 190° F (88° C)

Hi Limit (High Limit Setpoint) = 230° F (110° C)

Hi Limit Dif (High Limit Differential) = 20° F (11° C)

Both Models

Tempert Units (Temperature Units) = F

Post Cir Secs (Post Circulation pump delay) = 45 seconds

Network Address (Network Address) = (none)

## UIM Touch Switches

Below the LCD display are five touch switches or keys, that the operator uses to operate the system.

- **Menu Key:**

Pressing this key activates the menu screen where the other screens can be accessed.

- **Select Key:**

This key performs several functions. Screens can be selected from the menu screen by pressing this key when the ">" appears next to the screen desired.

On the User Settings screen items that appear next to a ">" symbol can be selected with this key. If a setpoint configuration item is selected, the ">" will then flash slowly to indicate that the item has been selected. The Up and Down keys are then used to change its value.

From the Current Error Screen this key is used to reset the system from an error:

- **Up and Down Keys:**

These keys are used to move upwards and downwards in screens to reach a desired item and to change setpoints and user settings. They have an auto increment/decrement feature for some of the configurations and values. When you first press one of the keys and value changes by 1 count, then wait 1/2 second and changes slowly until the key is released or if held for 3 or more seconds it will change the value quickly.

- **Help Key:**

Pressing the Help key from any screen displays helpful information about that screen. From the menu screen, general help information is displayed as to how to use the user interface. To return to the previous screen press the Help or Select keys, or press Menu key to go to the menu screen. If a small down arrow appears in the lower right hand corner then there is off screen content below what is displayed. Press the down arrow to scroll down to this information. After scrolling down an up arrow will appear in the upper right hand corner to indicate off screen content above what is displayed.

### **UIM LED's**

The three LED's to the right of the LCD indicate the status of the overall system. The red LED indicates that a fault

has been detected and the system has stopped running. It is on continuously for soft faults and flashes for hard faults. The Yellow LED indicates that the boiler is in a ready mode waiting for a call for heat command. When on continuously the Green LED indicates that the system is in the heating mode. If it is flashing it indicates that the UIM is in the initialization mode and the touch switches are being calibrated.

The VF® boiler has a display on the UIM which is a scaled display indicating the current firing rate of the boiler (25% to 100%).

### **Fault Messages and Troubleshooting Guide**

The EMC 5000 modulation system does excessive self-diagnostics and displays detected faults on the UIM display in an easy to read manner. There are approximately 80 different faults that can be detected. Some of the faults are caused by internal problems and some by external causes. The faults create different types of system lockouts (shut down). Hard lockouts are serious problems that require the user to manually restart the system. Soft lockouts can be reset by the user or after 60 minutes the system will automatically clear the error and restart. Auto Reset lockouts will monitor the cause of the fault and if the fault clears itself the system resets itself. The following table shows the fault messages and some possible troubleshooting hints:

## TROUBLESHOOTING IGNITION SYSTEM

Fault Messages and Lockout Status (\* = stage number: 1, 2, 3, or 4)

FAULT DISPLAYED	DESCRIPTION	RED LED	LOCKOUT
“Display Fail”	<b>Communications with UIM interrupted</b> Check communication cable to UIM. Try moving to other Internal Communications connector on MCB. Also check the connectors where the cable is plugged in for best connecting wires.	<b>Continuous</b>	<b>Auto Reset</b>
“Comm. Fail Stg.**”	<b>Communications with FCB interrupted</b> Same as above. Also try swapping FCB and UIM communications cables.	<b>Continuous</b>	<b>Auto Reset</b>
“Low AC Voltage”	<b>Line voltage less than 90 vac</b> Check incoming power line for loss of voltage. May also be caused by a power line brown-out (momentary loss of voltage)	<b>Continuous</b>	<b>Auto Reset</b>
“Low 24VAC”	<b>Voltage from transformer less than 18 vac</b> Check transformer output. Should be over 24vac. May be caused by excessive current drain or a faulty transformer	<b>Continuous</b>	<b>Auto Reset</b>
“Brown Out Reset”	<b>Indicates a brown out reset occurred</b> Caused by a momentary dip in voltage on the MCB +5vdc power bus. Contact factory. (Not considered a serious problem if it only occurs on very rare occasions.)	<b>---</b>	<b>None</b>
“Timeout Reset”	<b>Indicates a watchdog reset occurred</b> Caused when the micro executes the software in an improper way. Contact factory. (Not considered a serious problem if it only occurs on very rare occasions.)	<b>---</b>	<b>None</b>
“FCB Comm Timeout”	<b>FCB did not receive command from MCB</b> Caused when communications between the MCB and the FCB are interrupted. May occur when a surge of power on a nearby device (i.e. arc welder) creates an EMI burst. Not a serious problem if it occurs rarely.	<b>Continuous</b>	<b>SOFT</b>
“No Flow”	<b>Water is not flowing</b> Caused by the flow switch being open when it should be closed. Check water lines, pump, flow switch contacts, wiring.	<b>Continuous</b>	<b>SOFT</b>
“Blower Prov Stg*”	<b>Blower pressure is too low it they should have been closed.</b> Check blower, switch contact, wiring, and for air leaks.	<b>Continuous</b>	<b>SOFT</b>
“Blocked Flue”	<b>Flue is Blocked</b> Caused by the blocked flue switch contacts being open when they should have been closed. Check for flue blockage, switch contacts, wiring.	<b>Continuous</b>	<b>SOFT</b>
“Blocked Inlet”	<b>Air Inlet is blocked</b> Check inlet terminal, venturi screen and burner tube for debris. If inlet is clear check blocked inlet flue switch for continuity. Inspect hose to switch to ensure it is connected and not cracked or spilt.		
“High Limit”	<b>Outlet temp. exceeded high limit setpoint</b> Caused when the temperature of the outlet probe exceeds the high limit setpoint. This is an internal “software” limit switch and not an actual device. Check that the over temperature is not being caused by improper setup or operation of the boiler.	<b>Continuous</b>	<b>Auto Reset</b>
“MRHL”	<b>Outlet temp is too high</b> Caused when the MRHL (a thermostat) contacts in the Outlet probe are open when they should be closed. Fault may be due to high outlet temperature, bad switch contacts in the probe, or disconnected wiring. Note: The MRHL can be checked by disconnecting the outlet probe from the MCB and reading the resistance across the two active pins on the connector at the end of the probe cable. The value should be approximately 0 ohms when the temperature of the probe is less than 220°F.	<b>Flashing</b>	<b>HARD</b>
“Low Water”	<b>Water level is too low</b> Caused by the Low Water Cut Out device not closing its feedback switch contacts when it should. Check water line, switch contacts, wiring, LWCO.	<b>Flashing</b>	<b>HARD</b>
“Low Gas”	<b>Gas pressure is too low</b> Caused by the Low Gas switch being open when it should be closed. Check gas line, switch contacts, wiring.	<b>Flashing</b>	<b>HARD</b>
“Powered Accessory”	<b>Power vent not running</b> Caused by the Powered Vent device not closing its feedback switch contacts when it should. Could also be caused by a problem with the relay output on the MCB. Check output to powered vent, switch contacts, wiring.	<b>Flashing</b>	<b>HARD</b>
“High Gas Stg**”	<b>Gas pressure too high</b> Caused by the High Gas switch being open when it should be closed. Check gas line, switch contacts, wiring.	<b>Flashing</b>	<b>HARD</b>
“Inlet Probe”	<b>Inlet probe shorted or open</b> Caused when the thermistor in the probe or the wiring to the probe is shorted or disconnected. Check the probe. Note: The thermistor and wiring can be checked by disconnecting the probe from the MCB and reading the resistance across the two active pins on the connector at the end of the probe cable. The value should be approximately 10K ohms (value will change slightly with changes in temperature).	<b>Flashing</b>	<b>HARD</b>
“Outlet Probe:”	<b>Outlet probe shorted or open</b> Caused when the thermistor in the probe or the wiring is shorted or disconnected. Check the probe. Note: the thermistor and wiring can be checked by disconnecting the probe from the MCB and reading the resistance across the two active pins on the connector at the end of the probe cable. The value should be approximately 10K ohms (value will change slightly with changes in temperature).	<b>Flashing</b>	<b>HARD</b>
“Tank Probe”	<b>Tank (Remote) probe shorted or open</b> Caused when the thermistor in the probe or the wiring is shorted or disconnected. Check the probe. Note: the thermistor and wiring can be checked by disconnecting the probe from the MCB and reading the resistance across the two active pins on the connector at the end of the probe cable. The value should be approximately 10K ohms (value will change slightly with changes in temperature).	<b>Flashing</b>	<b>HARD</b>
“Igniter Stg**”	<b>Igniter current is too low</b> Caused by a low current draw problem with the igniter. This may occur if the igniter is old, damaged, or disconnected and no longer draws the proper level of current. This condition will affect the ability of the igniter to get hot enough to fire the gas properly. Check the igniter and its associated wiring.	<b>Flashing</b>	<b>HARD</b>
“Igniter Pwr Stg**”	<b>Improper power applied to the igniter circuit</b> Caused by improper line power being applied to the igniter circuitry. Check line connections. Paying particular attention to the earth ground connection. Also check that line voltage does not exceed 132 VAC RMS.	<b>Flashing</b>	<b>HARD</b>
“Igniter Hdwr Stg**”	<b>Hardware problems with igniter circuit</b>	<b>Flashing</b>	<b>HARD</b>

## TROUBLESHOOTING GAS VALVE

**Problem: Non-linear CO<sub>2</sub> curve on adjusted boiler (deviation more than 3-6%)**

1. Possible blockage at the air inlet that prevents uniform, constant air flow.
2. The gas inlet pressure is too low at full load.

**Problem: Unstable CO<sub>2</sub> level at minimum load**

The minimum load (low fire) is too low. The pressure difference on the pressure regulator at minimum load must be at least 0.2 in wc (50 Pa). If the pressure difference does not meet this requirement, it may be necessary to adjust low fire setting, see Setting Test Mode.

The pressure difference on the regulator can be measured between the venturi and the feedback tube. It is necessary to unscrew the pressure tap on the venturi for this measurement, and to close it afterwards.

With 17% of the reference load and a CO<sub>2</sub> level of 8.7%, it should be possible to reach this minimum pressure difference. If the CO<sub>2</sub> level is higher, the minimum power also has to be proportionally higher than 17%.

**Problem: No gas, no burner start up**

Check whether both coils of the two shutoff valves are energized and whether both shutoff valves are opening (you should hear a double "click" in the valve). Also check the gas inlet pressure.

**Problem: Gas OK, no burner start up (both shutoff valves are open, fan turns)**

There is not enough gas to accommodate a start up. Turn throttle screw ½ turn counterclockwise and try to start again with more gas.

**Problem: Boiler makes noise at high CO<sub>2</sub> level**

Premix-boilers may have a loud whistle noise problem at high CO<sub>2</sub> levels. This can sometimes be alleviated by decreasing the CO<sub>2</sub> level.

**Problem: Strong oscillations at burner start**

It is normal for a small oscillation to occur in the first second of the burner start. If the oscillation is very strong or lasts very long, decrease the resistance of the chimney by using a shorter tube with a larger diameter. An additional solution is to change the start up power of the burner.

**Problem: Nominal power of the mixing unit is unattainable**

Possible causes for this issue are:

1. the boiler and burner head pressure drop is too large;
2. fan not turning at correct speed.
3. sensing tube is clogged or broken.

**Problem: After some time, the pressure regulation of the valve fails**

Dirt in the valve finer than 0.013" (0.34mm) can prevent the correct function of the servo pressure regulator. Replace the valve and add a gas filter in front of the new valve.

## PREVENTATIVE MAINTENANCE

This is a pre-mix burner system. The flame is not supposed to be directly on the burner. The flame should be just above the burner deck approximately 1/8" and blue in color, see Figure 21.

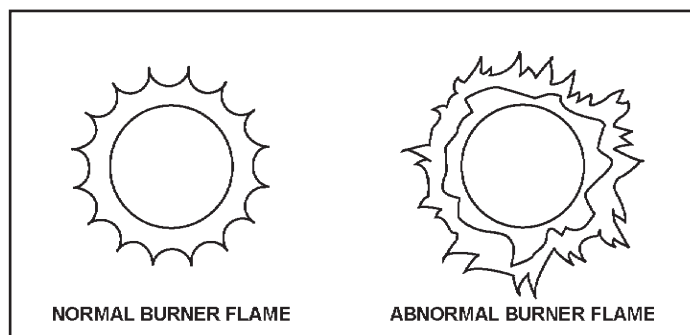

FIGURE 21. BURNER FLAMES

Visually check flame characteristics through the view port located on the top head of the boiler. Figure 21 shows the normal flame condition.

These boilers are designed to give many years of efficient and satisfactory service when properly operated and maintained. To assure continued good performance, the following recommendations are made.

The area around the unit should be kept clean and free from lint and debris. Sweeping the floor around the boiler should be done carefully. This will reduce the dust and dirt which may enter the burner and heat exchanger, causing improper combustion and sooting.

### MAIN BURNER

Check main burner every three months for proper flame characteristics. The main burner should display the following characteristics:

- Provide complete combustion of gas.
- Cause rapid ignition and carry over of flame across entire burner.
- Give reasonably quiet operation during initial ignition, operation and extinction.
- Cause no excessive lifting of flame from burner ports, see Figure 21.

If the preceding burner characteristics are not evident, check for accumulation of lint or other foreign material that restricts or blocks the air openings to the burner or boiler. To check burners:

1. Shut off all gas and electricity to unit. Allow unit to cool.
2. Remove main burners from unit.
3. Check that burner ports are free of foreign matter.
4. Clean burner with vacuum cleaner. DO NOT distort burner ports.
5. Reinstall burners in unit. Ensure that all the screws on the burner flange are tightened securely so that the gasket will provide a good seal.
6. Also check for good flow of combustion and ventilating air to the unit.

After placing the boiler in operation, check the ignition system safety shut-off devices for proper operation. To accomplish this with the main burner operating, close the valve on the manifold. Within four seconds the main burners should extinguish. If this does not occur immediately, discontinue gas supply by closing main manual shut-off and call a qualified service agent to correct the situation. If the burners extinguish, then light boiler in accordance with lighting and operating instructions.

## **! WARNING**

### **Combustion Air**

The flow of combustion air to the boiler must not be obstructed.

The boiler area must be kept clear and free from combustible materials, gasoline and other flammable vapors and liquids.

Any safety devices including low water cutoffs used in conjunction with this boiler should receive periodic (every six months) inspection to assure proper operation. A low water cutoff device of the float type should be flushed every six months. Periodic checks, at least twice a year, should be made for water leaks.

More frequent inspections may be necessary depending on water conditions.

The boiler-mounted gas and electrical controls have been designed to give both dependable service and long life. However, malfunction can occur, as with any piece of equipment. It is therefore recommended that all components be checked periodically by a qualified service agent for proper operation.

### **RELIEF VALVE**

The safety relief valve should be opened at least twice a year to check its working condition. This will aid in assuring proper pressure relief protection. Lift the lever at the top of the valve several times until the valve seats properly and operates freely.

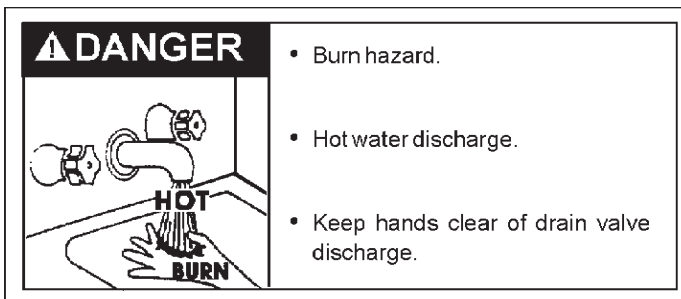

## **! WARNING**

### **Gas Supply**

Should overheating occur or the gas supply fail to shut off, turn off the manual gas control valve to the appliance.

### **COMBUSTION AIR FILTER**

If the combustion air supply to the boiler contains dust, dirt, drywall dust etc. a filter must be installed. An air filter is not supplied with the boiler as shipped from the factory. The installer must provide a filtering system in the air inlet to the boiler if dust, dirt or construction dirt can be pulled into the boiler through the inlet air piping. Periodically clean air filter per the manufacturer's instructions.

### **BLOWER COMPARTMENT**

The blower compartment should be cleaned annually to remove any dirt and lint that may have accumulated in the compartment

or on the blower and motor. Buildups of dirt and lint on the blower and motor can create excessive loads on the motor resulting in higher than normal operating temperatures and possible shortened service life.

### **BURNER MAINTENANCE**

Qualified servicers should follow this procedure when the boiler's burner needs cleaning.

1. Turn off the electrical power to the boiler and close the main manual gas shutoff valve(s). Allow the boiler parts to cool before disassembly.
2. Loosen the flange and separate the gas train from the manifold assembly.
3. Separate the burner from the blower adapter by first removing the four (4) bolts and subsequently, the blower gaskets. The blower should be free to move at this point.

**FOR DIRECT VENT UNITS:** It is necessary to loosen and slide the rubber coupling on the blower adaptor in order to move the blower.

4. Loosen the seven bolts on the blower adapter at the base and move the burner ground wire (Green) aside.
5. Lift the blower adapter and remove the manifold assembly up from the 6 studs located on the cover plate and remove the burner gasket.
6. Remove any loose foreign material such as dust or lint with a vacuum. Check all ports for blockage. Dislodge any foreign material causing blockage. Remove any soot or carbon deposits with a rag making sure to remove any lint left on the burner by vacuuming again.
7. Reverse the steps to reassemble the unit.
8. Restore electrical power and gas supply to the boiler.
  - Put the boiler back in operation by following the Lighting and Operating instructions in this manual.
  - Check for gas leaks and proper boiler and vent operation.

### **CONDENSATE REMOVAL SYSTEM**

Due to the highly efficient operation of this unit, condensate is formed during operation and must be removed by the condensate drain systems. Inspect the condensate drains and tubes at least once a month and insure they will allow the free flow of condensate at all times. The system must be inspected more frequently in cold weather if the drain system is located in an area, such as along the floor, where freezing temperatures are likely to occur. The condensate drain system must be protected against freezing. Contact a qualified service agent to inspect and correct the condition if freezing of the condensate lines is a problem. The unit is equipped with a blocked flue switch which will shut the unit off if condensate is unable to drain and backs up in the unit. A blocked flue error will appear when sufficient condensate accumulates for this condition.

The transparent drain lines and condensate drain on the bottom of the vent collector should be visually inspected at one month intervals for blockage, particularly in the areas of the loops in the lines which trap a small amount of condensate, and the exit point of the vent collector drain. Condensate in portions of the line other than the loop area indicates a blockage in the drain line. Flush the

lines with air or water and clear or replace the blocked portions of the line as necessary. Note that areas of the drain line which include a sag or low spot in the line will also form a condensate trap which can be removed by levelling the tube and does not indicate a blocked system.

Inspect the metal vent drain and vent collector drain connectors at six month intervals. Remove the hoses from the connections, then check with a small wooden dowel or plastic rod passed up through the metal connection to insure the passage is clear, using caution to not bend or damage the connector. Call a qualified service agent to inspect and correct the problem if any obstructions are found in the connectors. Replace all hoses and clamps immediately after inspection and before starting the boiler in accordance with the Lighting and Operating Instructions. **DO NOT OPERATE THE BOILER UNLESS ALL CONDENSATE DRAIN LINES ARE PROPERLY CONNECTED AND WORKING.** When a means to neutralize condensate has been installed you must also follow operating, inspection and maintenance procedures specified by the manufacturer of the product. Inspect the installed device to insure that it does not cause condensate to remain in the boiler or vent for any reason.

## VENTING MAINTENANCE

It is recommended that the intake and exhaust piping of the appliance be checked every 6 months for dust, condensate leakage, deterioration and carbon deposits.

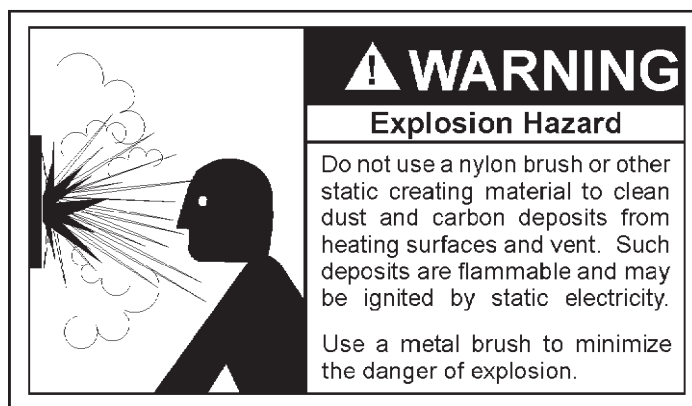

Qualified service agent should follow this procedure when the boiler's intake and exhaust piping need cleaning:

1. Turn off the electrical power, and manual gas shut-off.
  - Allow boiler parts to cool before disassembly.
2. Remove the vent pipe.
  - Check parts and chimney for obstructions and clean as necessary.
3. Remove burner from boiler and other metal parts as required to clean as necessary.
  - Refer to parts list for disassembly aid.
4. Clean and reinstall the parts removed in steps 2 and 3.
  - Be sure the vent pipe has a minimum upward pitch of 1/4" per foot (2cm/m) of length and is sealed as necessary.
5. Restore electrical power and gas supply to boiler.
  - Check for gas leaks and proper boiler and vent operation.

## HEAT EXCHANGER PREVENTATIVE MAINTENANCE

In most water supply systems solids exist. As the water is heated, these tend to drop out depositing as scale or lime. This scale must be removed before the heat exchanger tubes become blocked.

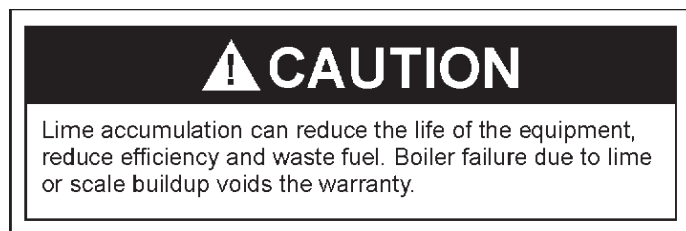

## DELIMING

The amount of calcium carbonate (lime) released from water is in direct proportion to water temperature and usage. The higher the water temperature or water usage, the more lime deposits are dropped out of the water. This is the lime scale which forms in pipes, boilers and on cooking utensils.

The usage of water softening equipment greatly reduces the hardness of water. However, this equipment does not always remove all of the hardness (lime). For this reason it is recommended that a regular schedule for deliming be maintained.

The time between cleaning will vary from two to six months depending upon water conditions and usage. A change of approximately 5°F (3°C) in the normal temperature rise through the boiler is usually an indication that scale should be removed. For long life, copper or brass is recommended for all valves, pipe and fittings.

## TUBE CLEANING PROCEDURE MECHANICAL REMOVAL OF DEPOSITS

Establish a regular inspection schedule, the frequency depends on the local water conditions and severity of service. Do not let the tubes clog up solidly. Clean out deposits over 1/16" (1.6mm) thickness.

To service heat exchanger tubes, remove return header casting on the side opposite the water connections. Use a U.S. standard 5/8" deep socket ratchet to remove the nuts, exposing the tube ends. Inspect to ensure tubes are free of scale and deposits. If scaled, remove deposits with a stiff wire brush or mechanical tube cleaner to bare metal. Reinstall return header casting. Flush system.

Note: Removal of the heat exchanger is not required.

## REPLACEMENT PARTS

Replacement parts may be ordered through A. O. Smith dealers, authorized servicers or distributors. Refer to the Yellow Pages for where to call or contact (in United States) the **A. O. Smith Water Products Company, 500 Tennessee Waltz Parkway, Ashland City, TN 37015, 1-800-433-2545** or (in Canada) **A. O. Smith Enterprises Ltd., 768 Erie Street, Stratford, Ontario, Canada N5A 6T3, 519-271-5800**. When ordering parts be sure to state the quantity, part number and description of the item including the complete model and serial number as it appears on the product. Refer to the parts lists for more information.

**For Technical Assistance call A. O. Smith Technical Information Center at 1-800-527-1953.**

# NOTES



# NOTES

# NOTES

# LIMITED WARRANTY

A. O. Smith Corporation, the warrantor, extends the following LIMITED WARRANTY to the owner of this boiler:

1. If within TEN years after initial installation of the boiler, a heat exchanger or gas burner shall prove upon examination by the warrantor to be defective in material or workmanship, the warrantor, at his option will exchange or repair such part or portion. This term is reduced to FIVE years if this boiler is used for water heating purposes other than hydronic space heating.
  - a. This warranty is extended to the owner for all other parts or portion during the FIRST year following initial installation of this boiler.
  - b. The warranty on the repair or replacement of the part or portion will be limited to the unexpired term of the original warranty.

## 2. CONDITIONS AND EXCEPTIONS

This warranty shall apply only when the boiler is installed in accordance with local plumbing and building codes, ordinances and regulations, the printed instructions provided with it and good industry practices. In addition, a pressure relief valve, certified by C.S.A. and approved by the American Society of Mechanical Engineers, must have been installed and fresh water used for filling and make-up purposes.

a. This warranty shall apply only when the boiler is used:

- (1) with inlet water temperature 120°F (49°C) and above and outlet water temperatures not exceeding the maximum setting of its operative and/or high limit control;
- (2) at water pressure not exceeding the working pressure shown on the boiler;
- (3) when filled with boiler water, free to circulate at all times and with the heat exchanger free of damaging scale deposits;
- (4) in a non-corrosive and non-contaminated atmosphere;
- (5) in the United States, its territories or possessions, and Canada;
- (6) at a water velocity flow rate not exceeding or below the boiler's designed rates;
- (7) indoor installation only.

b. Any accident to the boiler, any misuse, abuse (including freezing) or alteration of it, any operation of it in a modified form, or any attempt to repair leaks in the heat exchanger will void this warranty.

## 3. SERVICE AND REPAIR EXPENSE

Under this limited warranty the warrantor will provide only a replacement part. The owner is responsible for all other costs. Such costs may include but are not limited to:

- a. Labor charges for service, removal, repair, or reinstallation of the component part;
- b. Shipping, delivery, handling, and administrative charges for forwarding the replacement part from the nearest distributor and returning the claimed defective part to such distributor.
- c. All cost necessary or incidental for any material and/or permits required for installation of the replacement.

## 4. LIMITATIONS ON IMPLIED WARRANTIES

Implied warranties, including any warranty of merchantability imposed on the sale of this boiler under state or provincial law are limited to one (1) year duration for the boiler or any of its parts. Some states and provinces do not allow limitations on how long an implied warranty lasts, so the above limitation may not apply to you.

## 5. CLAIM PROCEDURE

Any claim under this warranty should be initiated with the dealer who sold the boiler, or with any other dealer handling the warrantor's products. If this is not practicable, the owner should contact:

### U.S. Customers

A. O. Smith Corporation  
500 Tennessee Waltz Parkway  
Ashland City, TN  
Telephone: 800 527-1953

### Canadian Customers

A. O. Smith Enterprises Ltd.  
P. O. Box, 310 - 768 Erie Street  
Stratford, Ontario N5A 6T3  
Telephone: 800-265-8520

- a. The warrantor will only honor replacement with identical or similar parts thereof which are manufactured or distributed by the warrantor.
- b. Dealer replacements are made subject to in-warranty validation by warrantor.

## 6. DISCLAIMERS

NO OTHER EXPRESS WARRANTY HAS BEEN OR WILL BE MADE ON BEHALF OF THE WARRANTOR WITH RESPECT TO THE MERCHANTABILITY OF THE BOILER OR THE INSTALLATION, OPERATION, REPAIR OR REPLACEMENT OF THE BOILER. THE WARRANTOR SHALL NOT BE RESPONSIBLE FOR WATER DAMAGE, LOSS OF USE OF THE UNIT, INCONVENIENCE, LOSS OR DAMAGE TO PERSONAL PROPERTY, OR OTHER CONSEQUENTIAL DAMAGE. THE WARRANTOR SHALL NOT BE LIABLE BY VIRTUE OF THIS WARRANTY OR OTHERWISE FOR DAMAGE TO ANY PERSONS OR PROPERTY, WHETHER DIRECT OR INDIRECT, AND WHETHER ARISING IN CONTRACT OR TORT.

- a. Some states and provinces do not allow the exclusion or limitation of the incidental or consequential damage, so the above limitations or exclusions may not apply to you.
- b. This warranty gives you specific legal rights, and you may also have other rights which vary from state to state or province to province.

Fill in the following for your own reference. Keep it. Registration is not a condition of warranty. The model and serial number are found on the boiler's rating plate.

Owner \_\_\_\_\_

Installation Address \_\_\_\_\_

City and State \_\_\_\_\_ Zip Code \_\_\_\_\_

Date Installed \_\_\_\_\_ Model No. \_\_\_\_\_ Serial No. \_\_\_\_\_

Dealer's Name \_\_\_\_\_ Phone No. \_\_\_\_\_

Dealer's Address \_\_\_\_\_

FILL IN WARRANTY AND KEEP FOR FUTURE REFERENCE



500 Tennessee Waltz Parkway, Ashland City, TN 37015  
Phone: 800-433-2545  
**www.hotwater.com E-Mail: parts@hotwater.com**

## Free Manuals Download Website

<http://myh66.com>

<http://usermanuals.us>

<http://www.somanuals.com>

<http://www.4manuals.cc>

<http://www.manual-lib.com>

<http://www.404manual.com>

<http://www.luxmanual.com>

<http://aubethermostatmanual.com>

Golf course search by state

<http://golfingnear.com>

Email search by domain

<http://emailbydomain.com>

Auto manuals search

<http://auto.somanuals.com>

TV manuals search

<http://tv.somanuals.com>