

COMMERCIAL GAS WATER HEATERS

POWER VENTED GAS MODELS W/HOT SURFACE IGNITION

A.O. Smith Water Heaters

Ashland City, TN 37015
www.hotwater.com

GAS-FIRED



WARNING: If the information in these instructions is not followed exactly, a fire or explosion may result causing property damage, personal injury or death.

- Do not store or use gasoline or other flammable vapors and liquids in the vicinity of this or any other appliance.
- **WHAT TO DO IF YOU SMELL GAS:**
 - Do not try to light any appliance.
 - Do not touch any electrical switch; do not use any phone in your building.
 - Immediately call your gas supplier from a neighbor's phone. Follow the gas supplier's instructions.
 - If you cannot reach your gas supplier, call the fire department.
- Installation and service must be performed by a qualified installer, service agency or the gas supplier.



	WARNING
	Read and understand instruction manual and safety messages before installing, operating or servicing this water heater. Failure to follow instructions and safety messages could result in death or serious injury. Instruction manual must remain with water heater.

• For Your Safety •
AN ODORANT IS ADDED TO THE GAS USED BY THIS WATER HEATER.

ALL TECHNICAL AND WARRANTY QUESTIONS: SHOULD BE DIRECTED TO THE LOCAL DEALER FROM WHOM THE WATER HEATER WAS PURCHASED. IF YOU ARE UNSUCCESSFUL, PLEASE WRITE TO THE COMPANY LISTED ON THE RATING PLATE ON THE WATER HEATER.

**KEEP THIS MANUAL IN THE POCKET ON HEATER FOR FUTURE REFERENCE
WHENEVER MAINTENANCE ADJUSTMENT OR SERVICE IS REQUIRED.**

SAFE INSTALLATION, USE AND SERVICE

Your safety and the safety of others is extremely important in the installation, use and servicing of this water heater.

Many safety-related messages and instructions have been provided in this manual and on your own water heater to warn you and others of a potential injury hazard. Read and obey all safety messages and instructions throughout this manual. It is very important that the meaning of each safety message is understood by you and others who install, use or service this water heater.



This is the safety alert symbol. It is used to alert you to potential personal injury hazards. Obey all safety messages that follow this symbol to avoid possible injury or death.



DANGER indicates an imminently hazardous situation which, if not avoided, could result in injury or death.



WARNING indicates a potentially hazardous situation which, if not avoided, could result in injury or death.



CAUTION indicates a potentially hazardous situation which, if not avoided, may result in minor or moderate injury.

CAUTION

CAUTION used without the safety alert symbol indicates a potentially hazardous situation which, if not avoided, could result in property damage.

All safety messages will generally tell you about the type of hazard, what can happen if you do not follow the safety message and how to avoid the risk of injury.

IMPORTANT DEFINITIONS

- **Qualified Installer:** A qualified installer must have ability equivalent to a licensed tradesman in the fields of plumbing, air supply, venting and gas supply, including a thorough understanding of the requirements of the National Fuel Gas Code as it relates to the installation of gas fired water heaters. The qualified installer must also be familiar with the design features of water heaters, and have a thorough understanding of this instruction manual.
- **Service Agency:** A service agency also must have ability equivalent to a licensed tradesman in the fields of plumbing, air supply, venting and gas supply, including a thorough understanding of the requirements of the National Fuel Gas Code as it relates to the installation of gas fired water heaters. The service agency must also have a thorough understanding of this instruction manual, and be able to perform repairs strictly in accordance with the service guidelines provided by the manufacturer.
- **Gas Supplier:** The Natural Gas or Propane Utility or service who supplies gas for utilization by the gas burning appliances within this application. The gas supplier typically has responsibility for the inspection and code approval of gas piping up to and including the Natural Gas meter or Propane storage tank of a building. Many gas suppliers also offer service and inspection of appliances within the building.



GENERAL SAFETY

	⚠ WARNING
	<p>Read and understand instruction manual and safety messages before installing, operating or servicing this water heater.</p> <p>Failure to follow instructions and safety messages could result in death or serious injury.</p> <p>Instruction manual must remain with water heater.</p>

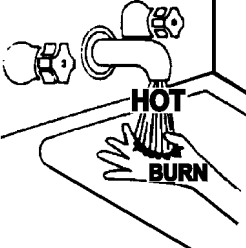
	⚠ WARNING
	Fire Hazard <p>For continued protection against risk of fire:</p> <ul style="list-style-type: none">• Do not install water heater on carpeted floor.• Do not operate water heater if flood damaged.

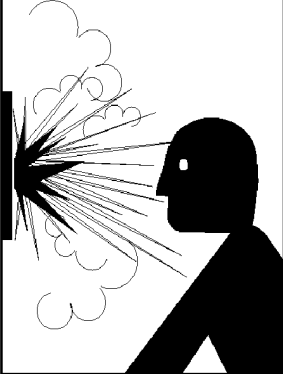
⚠ DANGER	<p>Water temperature over 125°F (52°C) can cause severe burns instantly resulting in severe injury or death.</p> <p>Children, the elderly, and the physically or mentally disabled are at highest risk for scald injury.</p> <p>Feel water before bathing or showering.</p> <p>Temperature limiting valves are available.</p> <p>Read instruction manual for safe temperature setting.</p>
	

	⚠ WARNING
	Explosion Hazard <ul style="list-style-type: none">• Overheated water can cause water tank explosion.• Properly sized temperature and pressure relief valve must be installed in opening provided.

⚠ WARNING	
Fire or Explosion Hazard	
<ul style="list-style-type: none">• Do not store or use gasoline or other flammable vapors and liquids in the vicinity of this or any other appliance.• Avoid all ignition sources if you smell LP gas.• Do not expose water heater control to excessive gas pressure.• Use only gas shown on rating plate.• Maintain required clearances to combustibles.• Keep ignition sources away from faucets after extended period of non-use.	
	<p>Read instruction manual before installing, using or servicing water heater.</p>
	

GENERAL SAFETY

CAUTION

Improper installation and use may result in property damage.

- Do not operate water heater if flood damaged.
- Inspect and replace anode.
- Install in location with drainage.
- Fill tank with water before operation.
- Be alert for thermal expansion.

Refer to instruction manual for installation and service.

⚠ WARNING



- Before servicing the water heater, make sure the blower assembly is unplugged or the electrical supply to the water heater is turned "OFF".
- Label all wires prior to disconnection when servicing controls. Wiring error can cause improper and dangerous operation. Verify proper operation after servicing.
- Failure to do this could result in death, serious bodily injury, or property damage.

⚠ WARNING

Breathing Hazard - Carbon Monoxide Gas

- Install vent system in accordance with codes.
- Do not operate water heater if flood damaged.
- High altitude models should be installed at elevations above 5,300 feet (1,615 m). For operation above 10,100 feet (3,079 m), a high altitude orifice must be installed.
- Do not operate if soot buildup is present.
- Do not obstruct water heater air intake with insulating jacket.
- Do not place chemical vapor emitting products near water heater.
- Gas and carbon monoxide detectors are available.
- No vent damper installation is compatible with this power vented water heater.
- Form an approximately 8" diameter loop in the condensate hoses on top of the water heater to trap water and prevent the escape of combustion by-products.
- Do not elevate the condensate hose on the bottom of the water heater above the bracket attached to the side of the unit. This must be true for the entire length of the hose including the exit into an appropriate drain.
- Condensate lines must be free and clear of debris and must not allow back flow through the hose. The condensate lines must be able to flow freely to an appropriate drain.
- Do not allow condensate lines to become crimped closed.
- Analyze the entire vent system to make sure that condensate will not become trapped in a section of vent pipe and therefore reduce the open cross sectional area of the vent.

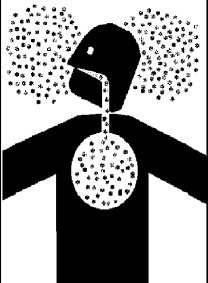

Breathing carbon monoxide can cause brain damage or death.
Always read and understand instruction manual.

⚠ DANGER



⚠ Vapors from flammable liquids may explode and catch fire causing death or severe burns.

Do not use or store flammable products such as gasoline, solvents or adhesives in the same room or area near the water heater.

Keep flammable products:

1. far away from heater,
2. in approved containers,
3. tightly closed and
4. out of children's reach.

Installation:

Do not install the water heater where flammable products will be stored or used unless the main burner and hot surface igniter are

Water heater has a main burner and hot surface igniter. The hot surface igniter:

1. can come on at any time and
2. will ignite flammable vapors.

Vapors:

1. cannot be seen,
2. are heavier than air,
3. go a long way on the floor and
4. can be carried from other rooms to the hot surface igniter by air currents.

at least 18" above the floor. This will reduce, but not eliminate, the risk of vapors being ignited by the main burner or hot surface igniter.

TABLE OF CONTENTS

SAFE INSTALLATION, USE AND SERVICE	2	Installation of Vent System	19-21
GENERAL SAFETY	3-4	Vent Attenuation Assembly Installation Instructions	22-23
TABLE OF CONTENTS	5	Vent Pipe Preparation	24-25
INTRODUCTION	5	LIGHTING & OPERATING LABEL	26
Preparing for the Installation	5	TEMPERATURE REGULATION	27
TYPICAL INSTALLATION	6-9	FOR YOUR INFORMATION	28
ROUGH IN DIMENSIONS	8	Start Up Conditions	
LOCATING THE NEW WATER HEATER	10-12	Smoke/Odor	28
Facts to Consider About Location	10-11	Thermal Expansion	28
Insulation Blankets	11	Strange Sounds	28
Combustion Air and Ventilation for Appliances		Operational Conditions	28
Located in Unconfined Spaces	11	Smelly Water	28
Combustion Air and Ventilation for Appliances		"Air" in Hot Water Faucets	28
Located in Confined Spaces	11-12	High Temperature Shut Off System	28
INSTALLING THE WATER HEATER	13-25	PERIODIC MAINTENANCE	29-31
Chemical Vapor Corrosion	13	Venting System Inspection	29
Water Piping	13-14	Burner Operation and Inspection	29
Temperature-Pressure Relief Valve	14	Burner Cleaning	29
Gas Piping	15	Housekeeping	29-30
Sediment Traps	16	Anode Rod Inspection	30
Filling the Water Heater	16	Temperature-Pressure Relief Valve Operation	30
Vent Pipe Assembly	16	Draining	30
Venting	16	Service	31
Vent Pipe Termination	17	LEAKAGE CHECKPOINTS	31
Planning the Vent System	18	TROUBLESHOOTING	32-34
Condensate	18-19	WARRANTY	35
Blower Assembly Installation	19		

INTRODUCTION

Thank You for purchasing this water heater. Properly installed and maintained, it should give you years of trouble free service.

Abbreviations Found In This Instruction Manual:

- CSA - Canadian Standards Association
- ANSI - American National Standards Institute
- NFPA - National Fire Protection Association
- ASME - American Society of Mechanical Engineers
- GAMA - Gas Appliance Manufacturer's Association
- UL - Underwriters Laboratories Inc.

This gas-fired water heater is design certified by Underwriters Laboratories Inc. under American National Standard/CSA Standard for Gas Water Heaters ANSI Z21.10.3 • CSA 4.3 (current edition).

PREPARING FOR THE INSTALLATION

1. Read the "General Safety" section, page 3 and 4 of this manual first and then the entire manual carefully. If you don't follow the safety rules, the water heater will not operate properly. It could cause DEATH, SERIOUS BODILY INJURY AND/OR PROPERTY DAMAGE.

This manual contains instructions for the installation, operation, and maintenance of the gas-fired water heater. It also contains warnings throughout the manual that you must read and be aware of. All warnings and all instructions are essential to the proper operation of the water heater and your safety. Since we cannot put everything on the first few pages, **READ THE ENTIRE MANUAL BEFORE ATTEMPTING TO INSTALL OR OPERATE THE WATER HEATER.**

2. The installation must conform with these instructions and the local code authority having jurisdiction. In the absence of local

codes, the installation must comply with the current editions of the National Fuel Gas Code, ANSI Z223.1/NFPA 54 and the National Electrical Code, NFPA 70 or CAN/CSA-B149.1, the Natural Gas and Propane Installation Code and CSA C22.1, the Canadian Electrical Code. All documents are available from the Canadian Standards Association, 8501 East Pleasant Valley Road, Cleveland, OH 44131. NFPA documents are also available from the National Fire Protection Association, 1 Batterymarch Park, Quincy, MA 02269.

3. The water heater when installed must be grounded in accordance with the local codes, or in the absence of local codes: the National Electrical Code (NFPA 70) or the Canadian Electrical Code (C22.1).
4. If after reading this manual you have any questions or do not understand any portion of the instructions, call the local gas utility or the manufacturer whose name appears on the rating plate.
5. Carefully plan the place where you are going to put the water heater. Correct combustion, vent action, and vent pipe installation are very important in preventing death from possible carbon monoxide poisoning and fires, see Figures 1 and 2.

Examine the location to ensure the water heater complies with the "Locating the New Water Heater" section in this manual.

6. For California installation this water heater must be braced, anchored, or strapped to avoid falling or moving during an earthquake. See instructions for correct installation procedures. Instructions may be obtained from California Office of the State Architect, 400 P Street, Sacramento, CA 95814.
7. Massachusetts Code requires this water heater to be installed in accordance with Massachusetts 248-CMR 2.00: State Plumbing Code and 248-CMR 5.00.
8. Complies with SCAQMD rule #1146 and districts having equivalent NOx requirements.

TYPICAL INSTALLATION

GET TO KNOW YOUR WATER HEATER - GAS MODELS

- | | | |
|---------------------------------------|--|----------------------------|
| A Vent Pipe | Q Rating Plate | HH Bushing |
| B Anode | R Insulation | II Nipple |
| C Hot Water Outlet | S Vent Terminal | JJ Condensate Tee |
| D Outlet (120 VAC) | T Drain Valve | KK Hose Barb |
| F Gas Supply | U Igniter And Main Burner | LL Plug |
| G Main Manual Gas Shut Off Valve | W Drain Pan | MM Vent Pipe Assembly #1 |
| H Ground Joint Union | X Control | NN Vent Pipe Assembly #2 |
| J Dirt Leg | Y Control Harness* | OO Vent Pipe Assembly #3 |
| K Outer Door | AA Motor & Blower | PP Side Recirculation Loop |
| L Union | CC Condensate Fitting (4 Places Shown)** | Inlet*** |
| M Inlet Water Shut Off Valve | DD Plastic Top | QQ Side Recirculation Loop |
| N Cold Water Inlet | EE On/Off Switch | Outlet*** (not shown) |
| O Inlet Dip Tube | FF Exhaust Tee | RR Vent Attenuation |
| P Temperature & Pressure Relief Valve | GG Elbow | Assembly (VAA) (Optional) |
| | | SS Access Door |

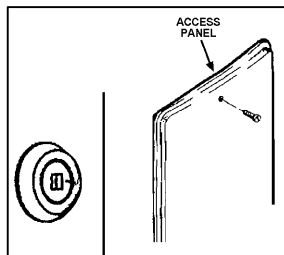
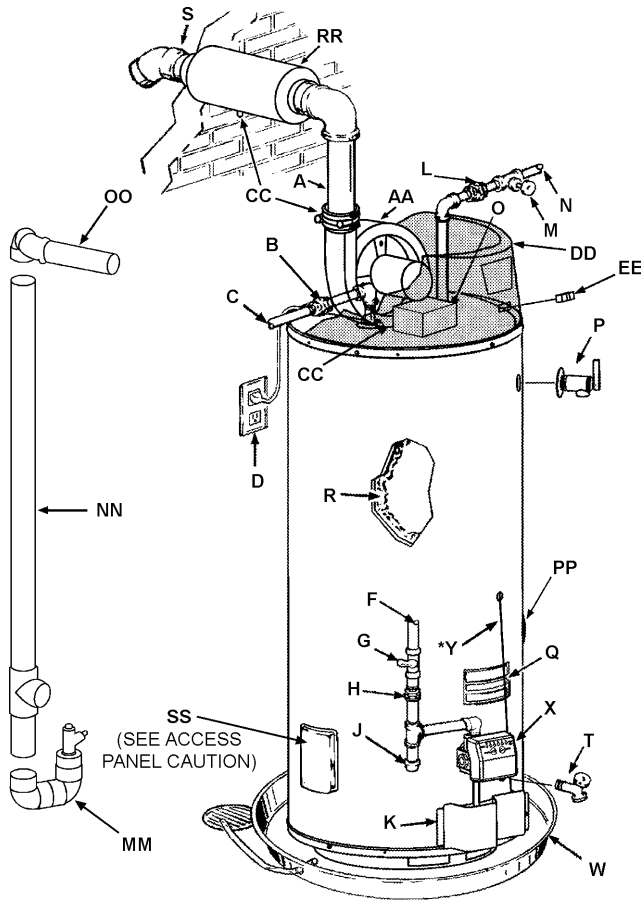

Caution: This access panel covers a 2" NPT plug that was required during the manufacturing of this water heater. This 2" NPT flange is **not** a cleanout fitting, removing the 2" NPT plug and using this fitting as a cleanout could void your warranty.

REPLACEMENT PARTS AND DELIMITING PRODUCTS

Replacement parts and recommended delimiting may be ordered through authorized servicers or distributors. When ordering parts, provide complete model and serial numbers (see rating plate), quantity and name of part desired. Standard hardware items may be purchased locally.

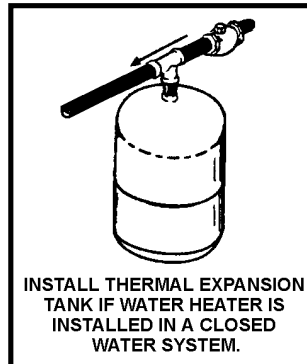

INSTALL THERMAL EXPANSION TANK IF WATER HEATER IS INSTALLED IN A CLOSED WATER SYSTEM.

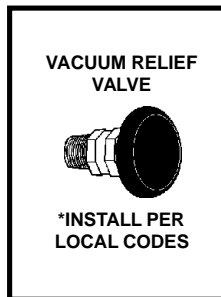
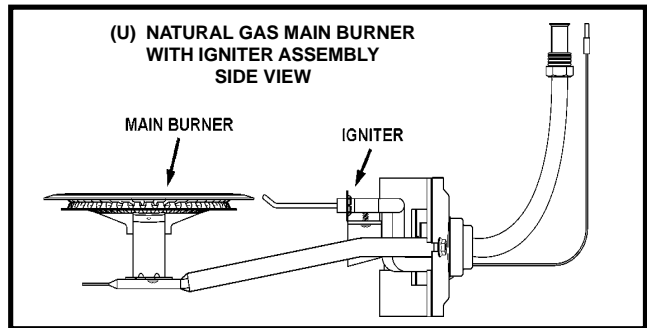
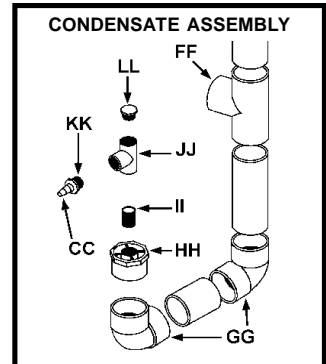

VACUUM RELIEF VALVE
*INSTALL PER LOCAL CODES

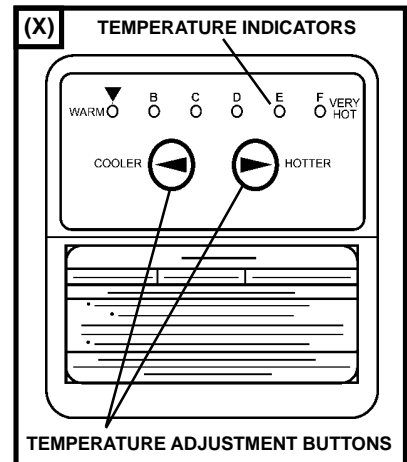

TEMPERATURE ADJUSTMENT BUTTONS

* CAUTION HARNESS HAS 120 VAC. IN OPERATION.

** See "PLANNING THE VENT SYSTEM", "CONDENSATE" and "BLOWER ASSEMBLY INSTALLATION" for more information.

***The side recirculation loop connections may *not* be used as the primary water inlet and outlet connections. For your convenience, plugs are installed in these fittings at the factory. Remove these plugs if needed for your specific installation. Otherwise (as with all connections) check for leaks while filling the tank with water and after completing the installation.

FIGURE 1

TYPICAL INSTALLATION

CONDENSATE HOSE AND DRAIN PAN

* Note: Condensate Trap Loops must be oriented in a vertical plane as shown. The traps also must be primed by filling half of the loop with water prior to operating the water heater. Carefully plan the location of the loops and straight sections of hose prior to cutting hoses. If necessary, secure the hoses to the side of the water heater or some other rigid structure to prevent crimping. While securing the hoses, do not pierce or crimp the hoses.

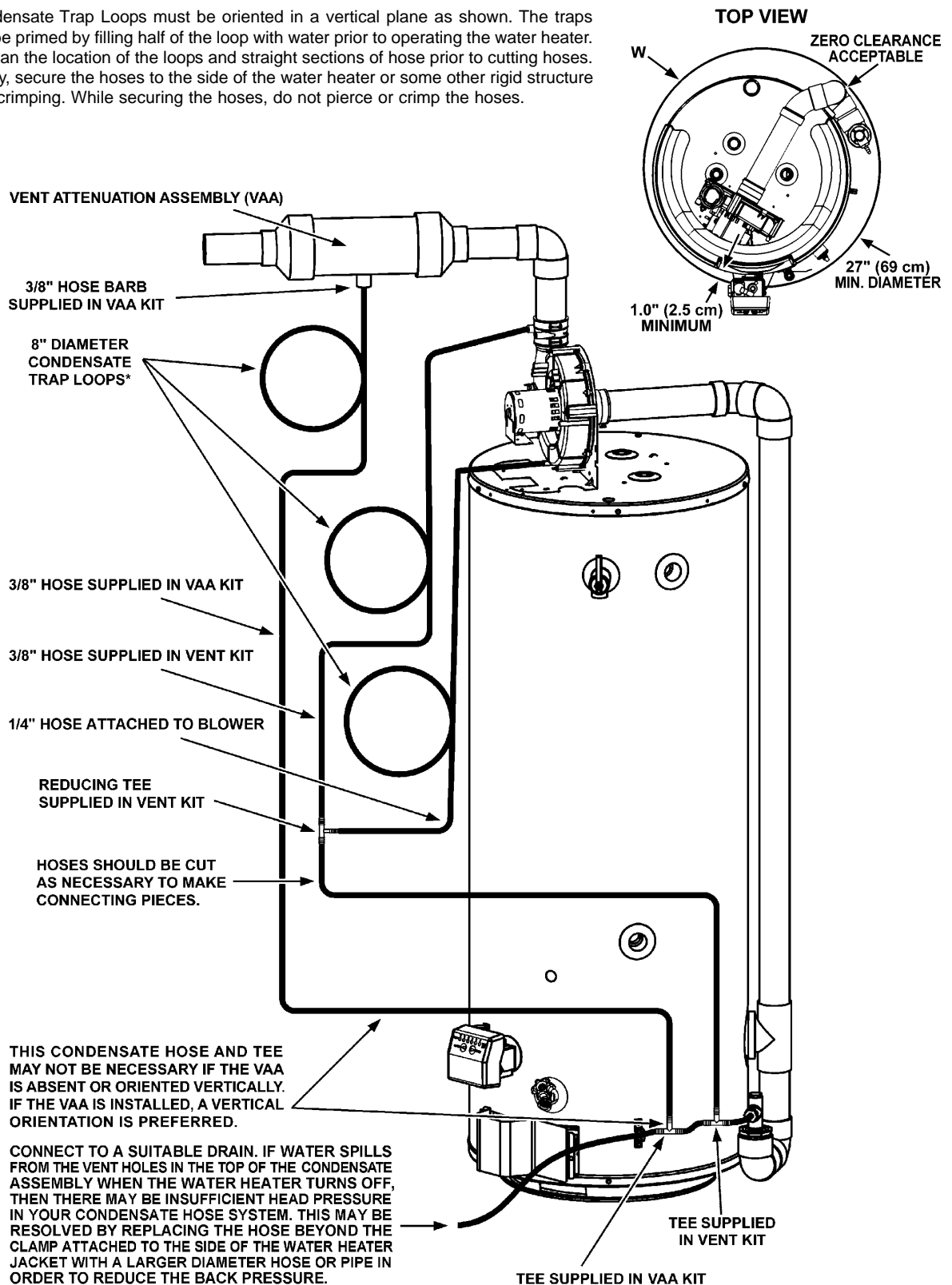
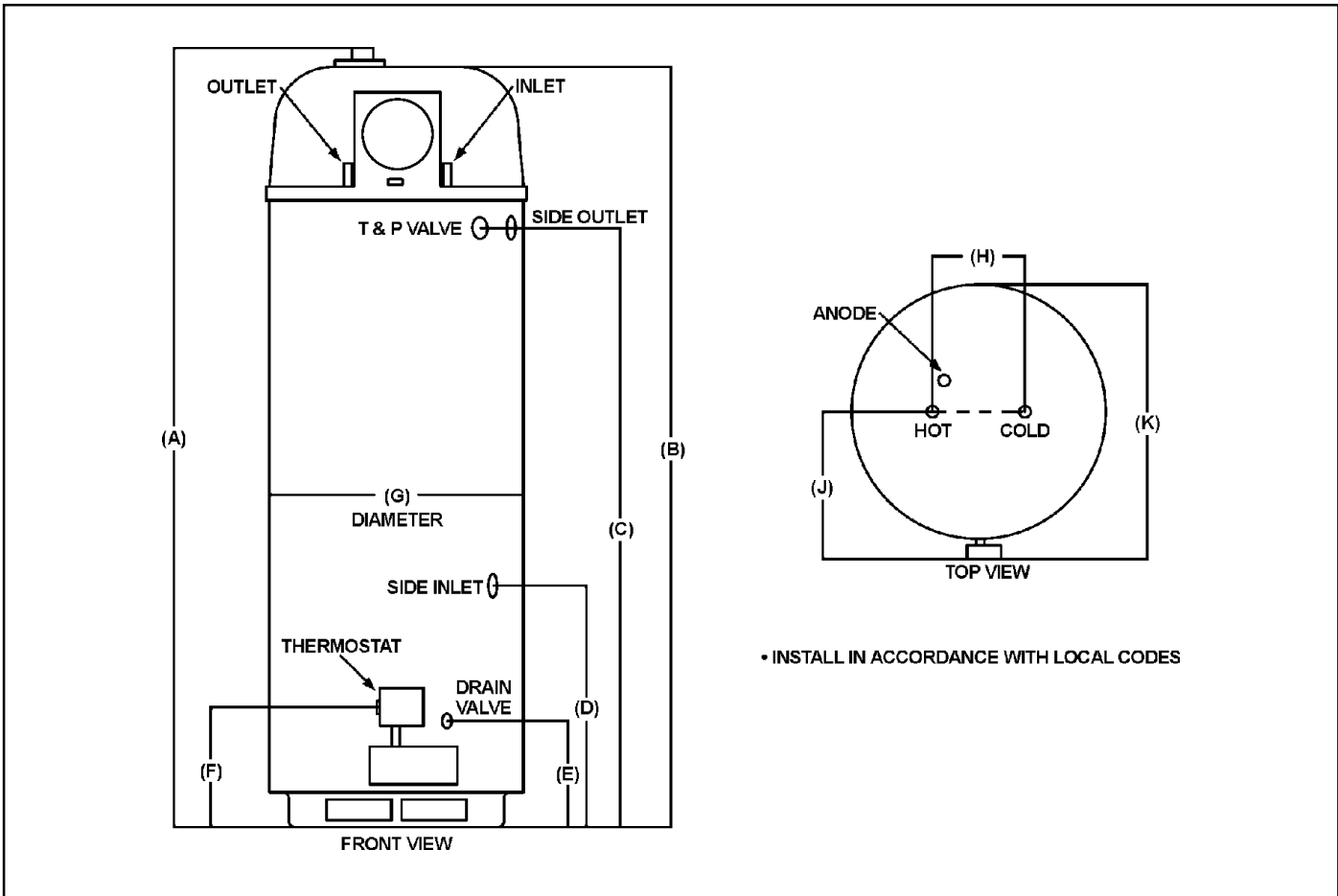

FIGURE 1 (continued).

ROUGH-IN-DIMENSIONS



• INSTALL IN ACCORDANCE WITH LOCAL CODES

Rough-In-Dimensions

Model	Units	A	B	C	D	E	F	G	H	J	K
BTX-80	Inches	70.62	68.20	51.90	20.90	9.15	12.00	22.00	8.00	15.81	26.92
	cm	179.37	173.23	131.83	53.09	23.24	30.48	55.88	20.32	40.16	68.38

Top/Side Inlet and Outlet: 3/4" NPT

Gas Inlet: 1/2" NPT

Capacity and Gas and Electrical Characteristics

Model	Approximate Capacity		Manifold Pressure			Electrical Characteristics	
	U.S. Gals.	Liters	Gas Type	"WC	kPA	Volts/Hz	Amperes
BTX-80	50	189	Nat.	4.00	0.99	120/60	<5

All models - Maximum Supply Pressure: 14 inches W.C. (3.48kPa)

Minimum Supply Pressure Natural Gas: 5.0 inches W.C. (1.24kPa)

Minimum Pressure must be maintained under both load and no load (static and dynamic) conditions.

Recovery Capacities - U.S. Gallons/Hr. and Liters/Hr. at Temperature Rise Indicated

Model	Input		Temp. Rise	Recovery Capacities												
	Rating (Btu/hr)	Rating (kW)		F°	30	40	50	60	70	80	90	100	110	120	130	140
				C°	17	22	28	33	39	44	50	56	61	67	72	78
BTX-80	76,000	22.25	GPH	275	206	165	138	118	104	92	83	75	69	64	59	
			LPH	1041	780	625	522	447	394	348	314	284	261	242	223	

Recovery capacity based on 90% thermal efficiency.

TYPICAL INSTALLATION

MIXING VALVE USAGE

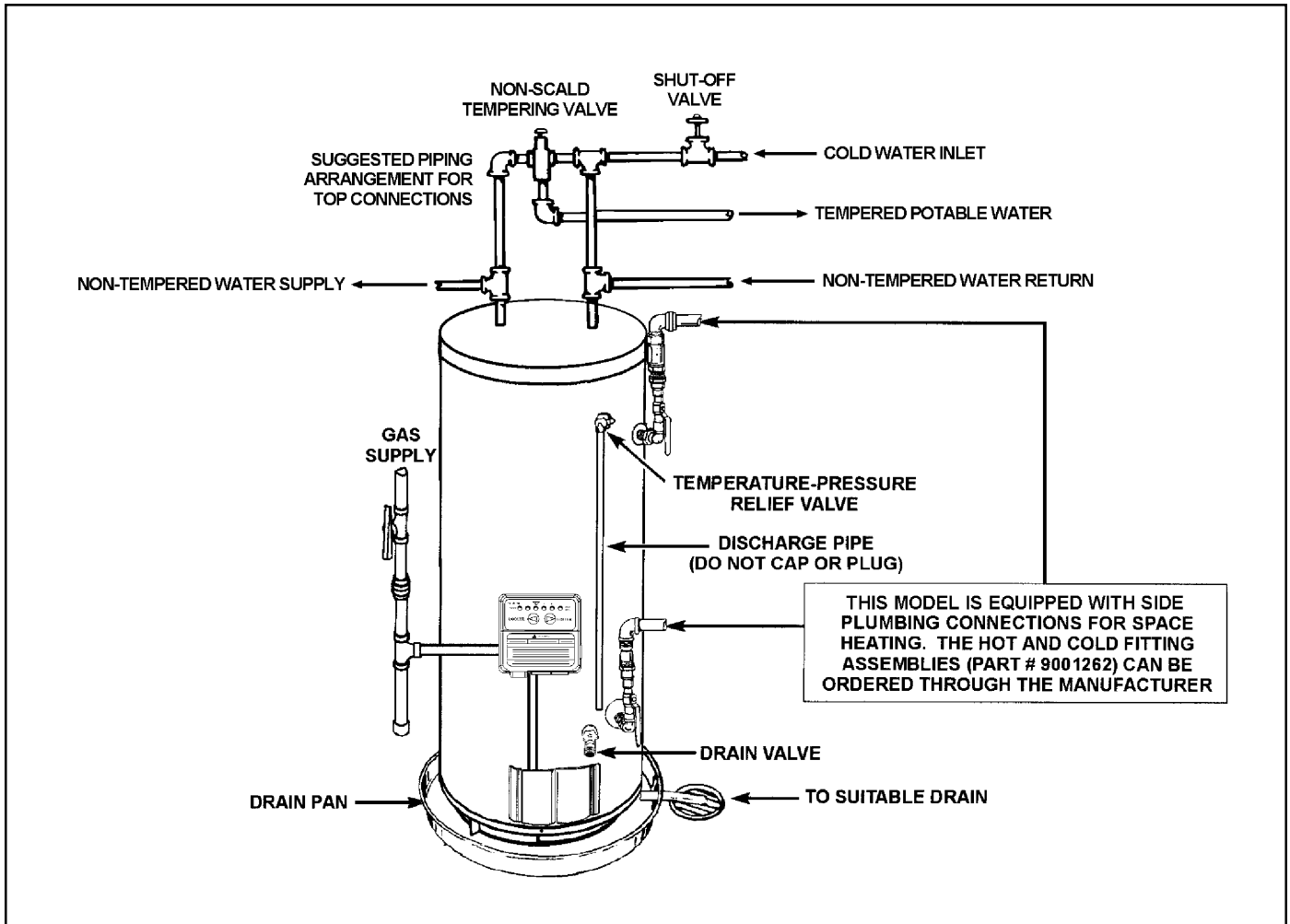

FIGURE 2.

This appliance has been design certified as complying with American National Standard/CSA Standard for water heaters and is considered suitable for:

Water (Potable) Heating and Space Heating: All models are considered suitable for water (potable) heating and space heating.

	<p>⚠ DANGER Water temperature over 125°F (52°C) can cause severe burns instantly resulting in severe injury or death.</p> <p>Children, the elderly, and the physically or mentally disabled are at highest risk for scald injury.</p> <p>Feel water before bathing or showering.</p> <p>Temperature limiting valves are available.</p> <p>Read instruction manual for safe temperature setting.</p>
--	--

HOTTER WATER CAN SCALD:

Water heaters are intended to produce hot water. Water heated to a temperature which will satisfy space heating, clothes washing, dish washing, and other sanitizing needs can scald and permanently injure you upon contact. Some people are more likely to be permanently injured by hot water than others. These include the elderly, children, the infirm, or physically/mentally handicapped. If anyone using hot water from this heater fits into one of these groups or if there is a local code or state law requiring a certain temperature water at the hot water tap, then you must take special precautions. In addition to using the lowest possible temperature setting that satisfies your hot water needs, a means such as a Mixing Valve, shall be used at the hot water taps used by these people or at the water heater. Mixing valves are available at plumbing supply or hardware stores. Consult a Qualified Installer or Service Agency. Follow mixing valve manufacturer's instructions for installation of the valves. Before changing the factory setting on the thermostat, read the "Temperature Regulation" section in this manual, see Figure 26.

LOCATING THE NEW WATER HEATER

FACTS TO CONSIDER ABOUT THE LOCATION

Carefully choose an indoor location for the new water heater, because the placement is a very important consideration for the safety of the occupants in the building and for the most economical use of the appliance. **This water heater is not for use in manufactured (mobile) homes or outdoor installation.**

Whether replacing an old water heater or putting the water heater in a new location, the following critical points must be observed:

1. Select a location indoors as close as practical to the vent terminal or location to which the water heater vent piping is going to be connected, and as centralized with the water piping system as possible.
2. Selected location must provide adequate clearances for servicing and proper operation of the water heater.

CAUTION

Property Damage Hazard

- All water heaters eventually leak.
- Do not install without adequate drainage.

Installation of the water heater must be accomplished in such a manner that if the tank or any connections should leak, the flow will not cause damage to the structure. For this reason, it is not advisable to install the water heater in an attic or upper floor. When such locations cannot be avoided, a suitable drain pan should be installed under the water heater. Drain pans are available at your local hardware store. Such a drain pan must have a clearance of at least 1.0" (2.5cm) greater than any point on the water heater's outer jacket and must be piped to an adequate drain. The pan must not restrict combustion air flow. For example, if a circular pan is used, it must be a minimum of 27" (69cm) in diameter. See Figure 1.

Water heater life depends upon water quality, water pressure and the environment in which the water heater is installed. Water heaters are sometimes installed in locations where leakage may result in property damage, even with the use of a drain pan piped to a drain. However, unanticipated damage can be reduced or prevented by a leak detector or water shut-off device used in conjunction with a piped drain pan. These devices are available from some plumbing supply wholesalers and retailers, and detect and react to leakage in various ways:

- Sensors mounted in the drain pan that trigger an alarm or turn off the incoming water to the water heater when leakage is detected.
- Sensors mounted in the drain pan that turn off the water supply to the entire building when water is detected in the drain pan.
- Water supply shut-off devices that activate based on the water pressure differential between the cold water and hot water pipes connected to the water heater.
- Devices that will turn off the gas supply to a gas water heater while at the same time shutting off its water supply.

INSTALLATIONS IN AREAS WHERE FLAMMABLE LIQUIDS (VAPORS) ARE LIKELY TO BE PRESENT OR STORED (GARAGES, STORAGE AND UTILITY AREAS, ETC.): Flammable liquids (such as gasoline, solvents, propane (LP or butane, etc.) and other substances (such as adhesives, etc.) emit flammable vapors which can be ignited by a gas water heater's hot surface igniter or main burner. The resulting flashback and fire can cause death or serious burns to anyone in the area.

Also, the water heater must be located and/or protected so it is not subject to physical damage by a moving vehicle.

WARNING

Fire or Explosion Hazard

- Do not store or use gasoline or other flammable vapors and liquids in the vicinity of this or any other appliance.
- Avoid all ignition sources if you smell LP gas.
- Do not expose water heater control to excessive gas pressure.
- Use only gas shown on rating plate.
- Maintain required clearances to combustibles.
- Keep ignition sources away from faucets after extended period of non-use.



Read instruction manual before installing, using or servicing water heater.



DANGER



Vapors from flammable liquids may explode and catch fire causing death or severe burns.

Do not use or store flammable products such as gasoline, solvents or adhesives in the same room or area near the water heater.

Keep flammable products:

1. far away from heater,
2. in approved containers,
3. tightly closed and
4. out of children's reach.

Water heater has a main burner and hot surface igniter. The hot surface igniter:

1. can come on at any time and
2. will ignite flammable vapors.

Vapors:

1. cannot be seen,
2. are heavier than air,
3. go a long way on the floor and
4. can be carried from other rooms to the hot surface igniter by air currents.

Installation:

Do not install the water heater where flammable products will be stored or used unless the main burner and hot surface igniter are

at least 18" above the floor. This will reduce, but not eliminate, the risk of vapors being ignited by the main burner or hot surface igniter.



WARNING

Fire Hazard

For continued protection against risk of fire:

- Do not install water heater on carpeted floor.
- Do not operate water heater if flood damaged.

This water heater must not be installed directly on carpeting. Carpeting must be protected by metal or wood panel beneath the appliance extending beyond the full width and depth of the appliance by at least 3" (7.6 cm) in any direction, or if the appliance is installed

in an alcove or closet, the entire floor must be covered by the panel. Failure to heed this warning may result in a fire hazard.

⚠ WARNING

Fire or Explosion Hazard



Read instruction manual before installing, using or servicing water heater.

- Improper use may result in fire or explosion.
- Maintain required clearances to combustibles.



Minimum clearances between the water heater and combustible construction are 0 inch at the sides and rear, 5.5" (14.0 cm) from the front and 12" (30.5 cm) from the top. (Standard clearance.) If clearances stated on the heater differ from standard clearances, install water heater according to clearances stated on the heater.

Adequate clearance 24" (61.0 cm) for servicing this appliance should be considered before installation, such as changing the anodes, etc.

A minimum clearance of 5.5" (14.0 cm) must be allowed for access to replaceable parts such as the thermostats, drain valve and relief valve.

When installing the heater, consideration must be given to proper location. Location selected should be as close to the wall as practicable and as centralized with the water piping system as possible.

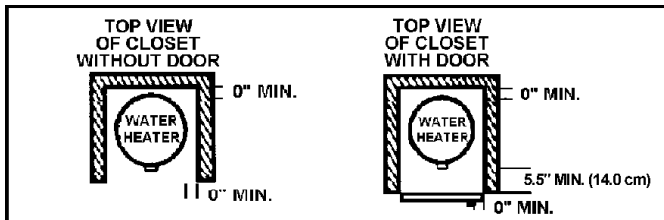
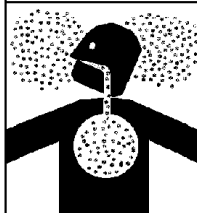

FIGURE 4.

A gas water heater cannot operate properly without the correct amount of air for combustion. Do not install in a confined area such as a closet, unless you provide air as shown in the "Locating The New Water Heater" section. Never obstruct the flow of ventilation air. If you have any doubts or questions at all, call your gas supplier. Failure to provide the proper amount of combustion air can result in a fire or explosion and cause death, serious bodily injury, or property damage.

⚠ WARNING

Breathing Hazard - Carbon Monoxide Gas



- Install water heater in accordance with the instruction manual and NF PA54 or CAN/CSA-B149.1
- To avoid injury, combustion and ventilation air must be taken from outdoors.
- Do not place chemical vapor emitting products near water heater.

Breathing carbon monoxide can cause brain damage or death. Always read and understand instruction manual.

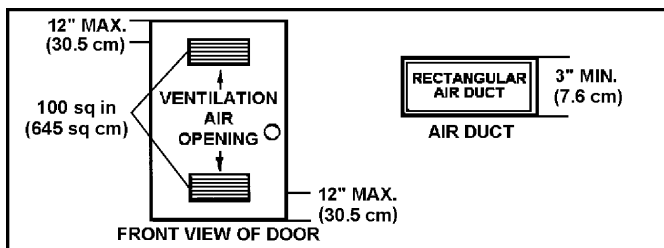

FIGURE 5.

If this water heater will be used in beauty shops, barber shops, cleaning establishments, or self-service laundries with dry cleaning equipment, it is imperative that the water heater or water heaters be installed so that combustion and ventilation air be taken from outside these areas.

Propellants of aerosol sprays and volatile compounds, (cleaners, chlorine based chemicals, refrigerants, etc.) in addition to being highly flammable in many cases, will also react to form corrosive hydrochloric acid when exposed to the combustion products of the water heater. The results can be hazardous, and also cause product failure.

INSULATION BLANKETS

Insulation blankets are available to the general public for external use on gas water heaters but are not necessary with these products. The purpose of an insulation blanket is to reduce the standby heat loss encountered with storage tank heaters. Your water heater meets or exceeds the Energy Policy Act standards with respect to insulation and standby loss requirements, making an insulation blanket unnecessary.

Should you choose to apply an insulation blanket to this heater, you should follow these instructions (For identification of components mentioned below, see Figure 1). Failure to follow these instructions can restrict the air flow required for proper combustion, potentially resulting in fire, asphyxiation, serious personal injury or death.

⚠ WARNING

Breathing Hazard - Carbon Monoxide Gas



- Do not obstruct water heater air intake with insulating blanket.
- Gas and carbon monoxide detectors are available.
- Install water heater in accordance with the instruction manual.

Breathing carbon monoxide can cause brain damage or death. Always read and understand instruction manual.

- Do not apply insulation to the top of the water heater, as this will interfere with safe operation of the blower assembly.
- Do not cover the outer door, thermostat or temperature & pressure relief valve.
- Do not allow insulation to come within 2" (5.1 cm) of the floor to prevent blockage of combustion air flow to the burner.
- Do not cover the instruction manual. Keep it on the side of the water heater or nearby for future reference.
- Do obtain new warning and instruction labels from the manufacturer for placement on the blanket directly over the existing labels.
- Do inspect the insulation blanket frequently to make certain it does not sag, thereby obstructing combustion air flow.

COMBUSTION AIR AND VENTILATION FOR APPLIANCES LOCATED IN UNCONFINED SPACES

UNCONFINED SPACE is space whose volume is not less than 50 cubic feet per 1,000 Btu per hour (4.8 cubic meters per kW) of the aggregate input rating of all appliances installed in that space. Rooms communicating directly with the space in which the appliances are installed, through openings not furnished with doors, are considered a part of the unconfined space.

In unconfined spaces in buildings, infiltration may be adequate to provide air for combustion, ventilation and dilution of flue gases. However, in buildings of tight construction (for example, weather stripping, heavily insulated, caulked, vapor barrier, etc.), additional air may need to be provided using the methods described in "Combustion Air and Ventilation for Appliances Located in Confined Spaces."

COMBUSTION AIR AND VENTILATION FOR APPLIANCES LOCATED IN CONFINED SPACES

CONFINED SPACE is a space whose volume is less than 50 cubic feet per 1,000 Btu per hour (4.8 cm per kW) of the aggregate input rating of all appliances installed in that space.

When drawing combustion air from inside a conventionally constructed building to a confined space, such a space shall be provided with two permanent openings. ONE WITHIN 12 INCHES (30 cm) OF THE ENCLOSURE TOP AND ONE WITHIN 12 INCHES (30 cm) OF THE ENCLOSURE BOTTOM. Each opening shall have

a free area of one square inch per 1000 Btu/hr (22 cm²/kW) of the total input of all appliances in the enclosure, but not less than 100 square inches (645 cm²).

If the confined space is within a building of tight construction, air for combustion and ventilation must be obtained from outdoors. When directly communicating with the outdoors or communicating through vertical ducts, two permanent openings, located in the above manner, shall be provided. Each opening shall have a free area of not less than one square inch per 4000 Btu/hr (5.5 cm²/kW) of total input of all appliances in the enclosure. If horizontal ducts are used, each opening shall have a free area of not less than one square inch per 2000 Btu/hr (11 cm²/kW) of the total input of all appliances in the enclosure.

A. ALL AIR FROM INSIDE BUILDINGS: (See Figure 5 and 6)

The confined space shall be provided with two permanent openings communicating directly with an additional room(s) of sufficient volume so that the combined volume of all spaces meets the criteria for an unconfined space. The total input of all gas utilization equipment installed in the combined space shall be considered in making this determination. Each opening shall have a minimum free area of one square inch per 1,000 Btu per hour (22 cm²/kW) of the total input rating of all gas utilization equipment in the confined space, but not less than 100 square inches (645 cm²). One opening shall commence within 12 inches (30 cm) of the top and one commencing within 12 inches (30 cm) of the bottom of the enclosures.

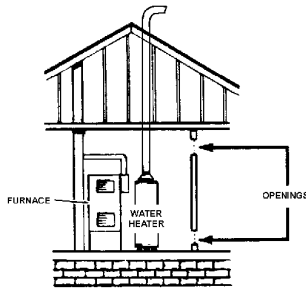

FIGURE 6.

B. ALL AIR FROM OUTDOORS: (See Figures 7, 8 and 9)

The confined space shall be provided with two permanent openings, one commencing within 12 inches (30 cm) of the top and one commencing within 12 inches (30 cm) from the bottom of the enclosure. The openings shall communicate directly, or by ducts, with the outdoors or spaces (crawl or attic) that freely communicate with the outdoors.

1. When directly communicating with the outdoors, each opening shall have a minimum free area of 1 square inch per 4,000 Btu per hour (5.5 cm²/kW) of total input rating of all equipment in the enclosure, see Figure 7.

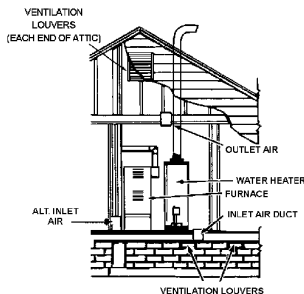

FIGURE 7.

2. When communicating with the outdoors through vertical ducts, each opening shall have a minimum free area of 1 square inch per 4,000 Btu per hour (5.5 cm²/kW) of total input rating of all equipment in the enclosure, see Figure 8.
3. When communicating with the outdoors through horizontal ducts, each opening shall have a minimum free area of 1 square inch per 2,000 Btu per hour (11 cm²/kW) of total input rating of all equipment in the enclosure, see Figure 9.

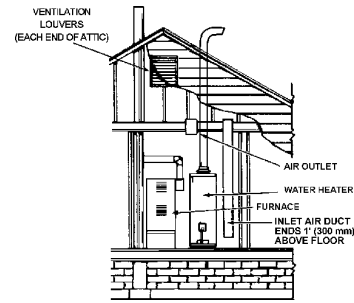

FIGURE 8.

4. When ducts are used, they shall be of the same cross-sectional area as the free area of the openings to which they connect. The minimum short side dimension of rectangular air ducts shall not be less than 3 inches (7.6 cm), see Figure 9.

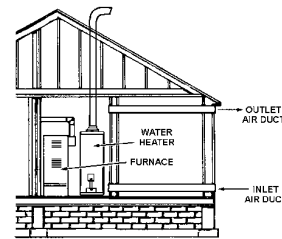

FIGURE 9.

5. Alternatively a single permanent opening may be used when communicating directly with the outdoors, or with spaces that freely communicate with the outdoors. The opening shall have a minimum free area of 1 square inch per 3,000 BTU per hour (8.3 cm²/kW) of total input rating of all equipment in enclosure. See Figure 9A.

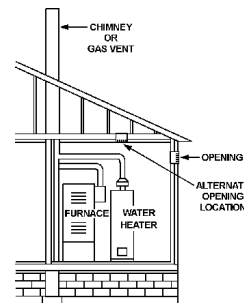

FIGURE 9A.

6. Louvers and Grilles: In calculating free area, consideration shall be given to the blocking effect of louvers, grilles or screens protecting openings. Screens used shall not be smaller than 1/4 inch (6.4 mm) mesh. If the free area through a design of louver or grille is known, it should be used in calculating the size opening required to provide the free area specified. If the design and free area is not known, it may be assumed that wood louvers will be 20-25 percent free area and metal louvers and grilles will have 60-75 percent free area. Louvers and grilles shall be fixed in the open position or interlocked with the equipment so that they are opened automatically during equipment operation.
7. Special Conditions Created by Mechanical Exhausting or Fireplaces: operation of exhaust fans, ventilation systems, clothes dryers or fireplaces may create conditions requiring special attention to avoid unsatisfactory operation of installed gas utilization equipment.

INSTALLING THE NEW WATER HEATER

CHEMICAL VAPOR CORROSION

CORROSION OF THE FLUEWAYS AND VENT SYSTEM MAY OCCUR IF AIR FOR COMBUSTION CONTAINS CERTAIN CHEMICAL VAPORS. SUCH CORROSION MAY RESULT IN FAILURE AND RISK OF ASPHYXIATION.

Spray can propellants, cleaning solvents, refrigerator and air conditioning refrigerants, swimming pool chemicals, calcium and sodium chloride (water softener salt), waxes, and process chemicals are typical compounds which are potentially corrosive.

Do not store products of this sort near the heater. Also, air which is brought in contact with the heater should not contain any of these chemicals. If necessary, uncontaminated air should be obtained from remote or outside sources. The limited warranty is voided when failure of water heater is due to a corrosive atmosphere. (See limited warranty for complete terms and conditions).

WATER PIPING

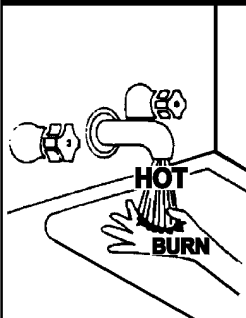
	<p>▲ DANGER Water temperature over 125°F (52°C) can cause severe burns instantly resulting in severe injury or death.</p> <p>Children, the elderly, and the physically or mentally disabled are at highest risk for scald injury.</p> <p>Feel water before bathing or showering.</p> <p>Temperature limiting valves are available.</p> <p>Read instruction manual for safe temperature setting.</p>
--	--

HOTTER WATER CAN SCALD:

Water heaters are intended to produce hot water. Water heated to a temperature which will satisfy space heating, clothes washing, dish washing, cleaning and other sanitizing needs can scald and permanently injure you upon contact. Some people are more likely to be permanently injured by hot water than others. These include the elderly, children, the infirm, or physically/mentally handicapped. If anyone using hot water fits into one of these groups or if there is a local code or state law requiring a certain temperature water at the hot water tap, then you must take special precautions. In addition to using the lowest possible temperature setting that satisfies your hot water needs, a means such as a "mixing valve, shall be used at the hot water taps used by these people or at the water heater, see Figure 2. Valves for reducing point of use temperature by mixing cold and hot water are also available:

Consult a Qualified Installer or Service Agency. Follow manufacturer's instructions for installation of the valves. Before changing the factory setting on the thermostat, read the "Temperature Regulation" section in this manual.

<p>▲ WARNING</p> <p>Toxic Chemical Hazard</p>
<ul style="list-style-type: none"> Do not connect to non-potable water system.

This water heater shall not be connected to any heating systems or component(s) used with a non-potable water heating appliance.

All piping components connected to this unit for space heating applications shall be suitable for use with potable water.

Toxic chemicals, such as those used for boiler treatment shall not be introduced into this system.

When the system requires water for space heating at temperatures higher than required for domestic water purposes, a tempering valve must be installed. Please refer to Figure 2 for suggested piping arrangement.

Water supply systems may, because of such events as high line pressure, frequent cut-offs, the effects of water hammer among others, have installed devices such as pressure reducing valves, check valves, back flow preventers, etc. to control these types of problems. When these devices are not equipped with an internal by-pass, and no other measures are taken, the devices cause the water system to be closed. As water is heated, it expands (thermal expansion) and closed systems do not allow for the expansion of heated water.

The water within the water heater tank expands as it is heated and increases the pressure of the water system. If the relieving point of the water heater's temperature-pressure relief valve is reached, the valve will relieve the excess pressure. **The temperature-pressure relief valve is not intended for the constant relief of thermal expansion.** This is an unacceptable condition and must be corrected.

It is recommended that any devices installed which could create a closed system have a by-pass and/or the system have an expansion tank to relieve the pressure built by thermal expansion in the water system. Expansion tanks are available for ordering through a local plumbing contractor. Contact the local water supplier and/or a service agency for assistance in controlling these situations.

NOTE: To protect against untimely corrosion of hot and cold water fittings, it is strongly recommended that di-electric unions or couplings be installed on this water heater when connected to copper pipe.

All gas piping must comply with local codes and ordinances or with the National Fuel Gas Code (ANSI Z223.1/ NFPA-54) or the Natural Gas and Propane Installation Code (CAN/CSA B149.1) whichever applies. Copper and brass tubing and fittings (except tin lined copper tubing) shall not be used.

<p>CAUTION</p> <p>Property Damage Hazard</p>
<ul style="list-style-type: none"> Avoid water heater damage. Install thermal expansion tank if necessary. Do not apply heat to cold water inlet. Contact qualified installer or service agency.

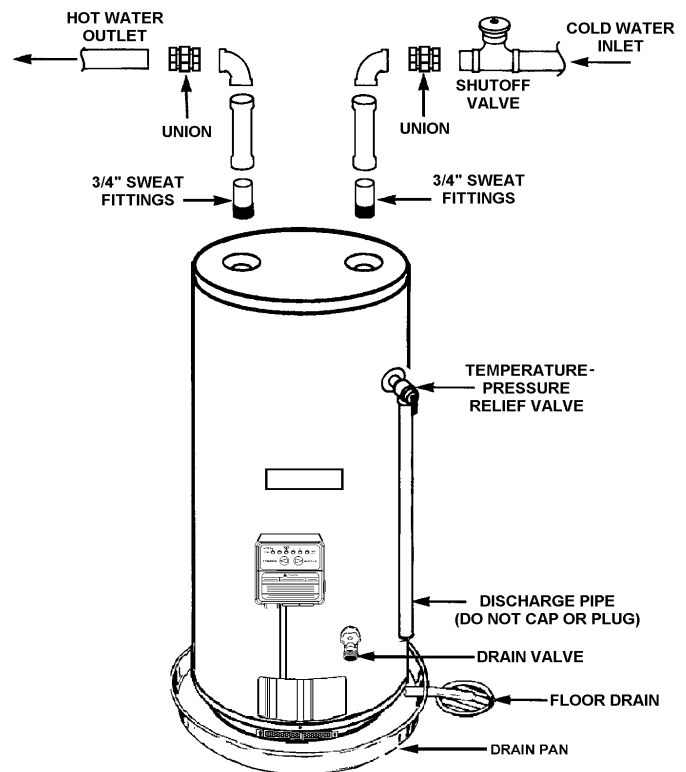

FIGURE 10.

Figure 10 shows the typical attachment of the water piping to the water heater. The water heater is equipped with 3/4 inch NPT water connections.

NOTE: If using copper tubing, solder tubing to an adapter before attaching the adapter to the water heater connections. Do not solder the water lines directly to the water heater connections. It will harm the dip tube and damage the tank.

T & P Valve and Pipe Insulation (if supplied)

Remove insulation for T & P valve and pipe connections from carton.

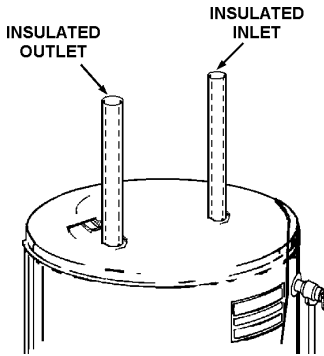

FIGURE 11.

Fit pipe insulation over the incoming cold water line and the hot water line. Make sure that the insulation is against the top cover of the heater. Fit T & P valve insulation over valve. Make sure that the insulation does not interfere with the lever of the T & P valve.

Secure all insulation using tape.

TEMPERATURE-PRESSURE RELIEF VALVE

	<p>⚠ WARNING</p> <p>Explosion Hazard</p>
	<ul style="list-style-type: none"> • Temperature-pressure relief valve must comply with ANSI Z21.22- CSA 4.4 and ASME code. • Properly sized temperature-relief valve must be installed in opening provided. • Can result in overheating and excessive tank pressure. • Can cause serious injury or death.

This heater is provided with a properly certified combination temperature - pressure relief valve by the manufacturer.

The valve is certified by a nationally recognized testing laboratory that maintains periodic inspection of production of listed equipment of materials as meeting the requirements for Relief Valves for Hot Water Supply Systems, ANSI Z21.22 • CSA 4.4, and the code requirements of ASME.

If replaced, the valve must meet the requirements of local codes, but not less than a combination temperature and pressure relief valve certified as indicated in the above paragraph.

The valve must be marked with a maximum set pressure not to exceed the marked hydrostatic working pressure of the water heater (150 psi = 1,035 kPa) and a discharge capacity not less than the water heater input rate as shown on the model rating plate.

For safe operation of the water heater, the relief valve must not be removed from its designated opening nor plugged.

The temperature-pressure relief valve must be installed directly into the fitting of the water heater designed for the relief valve. Position the valve downward and provide tubing so that any discharge will exit only within 6 inches (15.2 cm) above, or at any distance below the structural floor. Be certain that no contact is made with any live electrical part. The discharge opening must not be blocked or reduced in size under any circumstances. Excessive length, over 30 feet (9.14 m), or use of more than four elbows can cause restriction and reduce the discharge capacity of the valve, see Figures 10 or 14.

No valve or other obstruction is to be placed between the relief valve and the tank. Do not connect tubing directly to discharge drain unless a 6" (15.2 cm) air gap is provided. To prevent bodily injury, hazard to life, or property damage, the relief valve must be allowed to discharge water in quantities should circumstances demand. If the discharge pipe is not connected to a drain or other suitable means, the water flow may cause property damage.

<p>CAUTION</p> <p>Water Damage Hazard</p>
<ul style="list-style-type: none"> • Temperature-pressure relief valve discharge pipe must terminate at adequate drain.

The Discharge Pipe:

- Shall not be smaller in size than the outlet pipe size of the valve, or have any reducing couplings or other restrictions.
- Shall not be plugged or blocked.
- Shall be of material listed for hot water distribution.
- Shall be installed so as to allow complete drainage of both the temperature-pressure relief valve, and the discharge pipe.
- Shall terminate at an adequate drain.
- Shall not have any valve between the relief valve and tank.

	<p>⚠ DANGER Water temperature over 125°F (52°C) can cause severe burns instantly resulting in severe injury or death.</p> <p>Children, the elderly, and the physically or mentally disabled are at highest risk for scald injury.</p> <p>Feel water before bathing or showering.</p> <p>Temperature limiting valves are available.</p> <p>Read instruction manual for safe temperature setting.</p>
--	--

The temperature-pressure relief valve must be manually operated at least once a year. Caution should be taken to ensure that (1) no one is in front of or around the outlet of the temperature-pressure relief valve discharge line, and (2) the water manually discharged will not cause any bodily injury or property damage because the water may be extremely hot.

If after manually operating the valve, it fails to completely reset and continues to release water, immediately close the cold water inlet to the water heater, follow the draining instructions, and replace the temperature-pressure relief valve with a new one.

GAS PIPING

	<h3>⚠ WARNING</h3>
	<h4>Fire and Explosion Hazard</h4> <ul style="list-style-type: none"> • Do not use water heater with any gas other than the gas shown on the rating plate. • Excessive pressure to gas control valve can cause serious injury or death. • Turn off gas lines during installation. • Contact qualified installer or service agency.

Make sure the gas supplied is the same type listed on the model rating plate. The inlet gas pressure must not exceed 14 inch water column (3.5 kPa) for natural and propane gas (L.P.). The minimum inlet gas pressure shown on the rating plate is that which will permit firing at rated input.

All gas piping must comply with local codes and ordinances or with the National Fuel Gas Code (ANSI Z223.1/NFPA-54) or the Natural Gas and Propane Installation Code (CAN/CSA B149.1) whichever applies. Copper or brass tubing and fittings (except tin lined copper tubing) shall not be used.

If the gas control valve is subjected to pressures exceeding 1/2 psi (3.5 kPa), the damage to the gas control valve could result in a fire or explosion from leaking gas.

If the main gas line Shut-off serving all gas appliances is used, also turn "off" the gas at each appliance. Leave all gas appliances shut "off" until the water heater installation is complete.

A gas line of sufficient size must be run to the water heater. Consult the current edition of National Fuel Gas Code (ANSI Z223.1/NFPA 54) or the Natural Gas and Propane Installation Code (CAN/CSA B149.1) and your gas supplier concerning pipe size.

There must be:

- A readily accessible manual shut off valve in the gas supply line serving the water heater, and
- A drip leg (sediment trap) ahead of the gas control valve to help prevent dirt and foreign materials from entering the gas control valve.
- A flexible gas connector or a ground joint union between the shut off valve and control valve to permit servicing of the unit.

Be sure to check all the gas piping for leaks before lighting the water heater. Use a soapy water solution, not a match or open flame. Rinse off soapy solution and wipe dry.

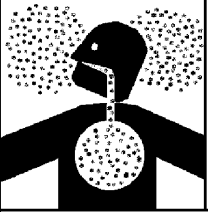
<h3>⚠ WARNING</h3>	
<h4>Breathing Hazard - Carbon Monoxide Gas</h4>	
	<ul style="list-style-type: none"> • High altitude models should be installed at elevations above 5,300 feet (1,615 m). For operation above 10,100 feet (3,079 m), a high altitude orifice must be installed. • Contact a qualified installer or service agency.
<p>Breathing carbon monoxide can cause brain damage or death. Always read and understand instruction manual.</p>	

This heater is approved for operation up to 5,300 feet (1,615 m) without alteration. High altitude models are available from the factory for elevations between 5,300 feet (1,615 m) and 10,100 feet (3,079 m). For elevations above 10,100 feet (3,079 m) the input rating should be reduced at the rate of 4 percent for each 1,000 feet (305 m) above sea level which requires replacement of the burner orifice in accordance with National Fuel Gas Code (ANSI Z223.1/NFPA 54) or the Natural Gas and Propane Installation Code (CAN/CSA B149.1). Contact your local gas supplier for further information.

Failure to replace the standard orifice with a high altitude orifice when installed above 10,100 feet (3,079 m) could result in improper and inefficient operation of the appliance, producing carbon monoxide gas in excess of safe limits, which could result in serious injury or death. Contact your gas supplier for any specific changes which may be required in your area.

	<h3>⚠ WARNING</h3>
	<h4>Fire and Explosion Hazard</h4> <ul style="list-style-type: none"> • Use joint compound or tape compatible with propane. • Leak test before operating heater. • Disconnect gas piping and shut-off valve before pressure testing system.

Use pipe joint compound or teflon tape marked as being resistant to the action of petroleum [Propane (L.P.)] gases.

The appliance and its gas connection must be leak tested before placing the appliance in operation.

The appliance and its individual Shut-off valve shall be disconnected from the gas supply piping system during any pressure testing of that system at test pressures in excess of 1/2 pound per square inch (3.5 kPa). It shall be isolated from the gas supply piping system by closing its individual manual Shut-off valve during any pressure testing of the gas supply piping system at test pressures equal to or less than 1/2 pound per square inch (3.5 kPa).

Connecting the gas piping to the gas control valve of the water heater can be accomplished by either of the two methods shown in Figures 12 and 13.

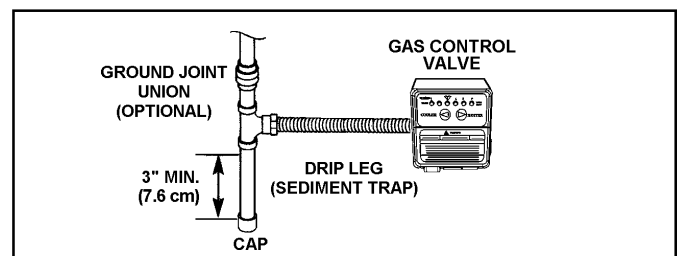

FIGURE 12. GAS PIPING WITH FLEXIBLE CONNECTOR.

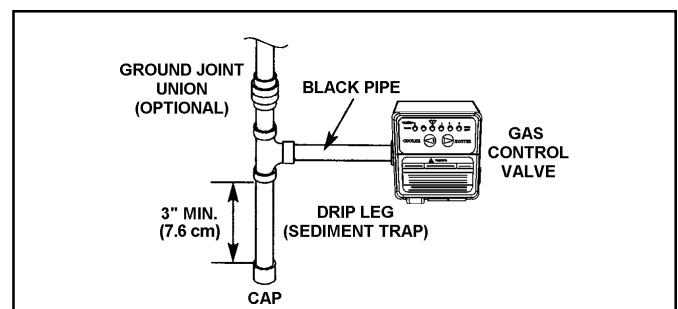



FIGURE 13. GAS PIPING WITH ALL BLACK IRON PIPE TO GAS CONTROL.

SEDIMENT TRAPS



⚠ WARNING

Fire and Explosion Hazard

- Contaminants in gas lines can cause fire or explosion.
- Clean all gas piping before installation.
- Install drip leg in accordance with NFPA54 or CAN/CSA-B149.1.

A sediment trap shall be installed as close to the inlet of the water heater as practical at the time of water heater installation. The sediment trap shall be either a tee fitting with a capped nipple in the bottom outlet or other device recognized as an effective sediment trap. If a tee fitting is used, it shall be installed in conformance with one of the methods of installation shown in Figures 12 and 13.

Contaminants in the gas lines may cause improper operation of the gas control valve that may result in fire or explosion. Before attaching the gas line be sure that all gas pipe is clean on the inside. To trap any dirt or foreign material in the gas supply line, a drip leg (sometimes called a sediment trap) must be incorporated in the piping. The drip leg must be readily accessible. Install in accordance with the "Gas Piping" section. Refer to the current edition of the National Fuel Gas Code (ANSI Z223.1/NFPA 54) or the Natural Gas and Propane Installation Code (CAN/CSA B149.1).

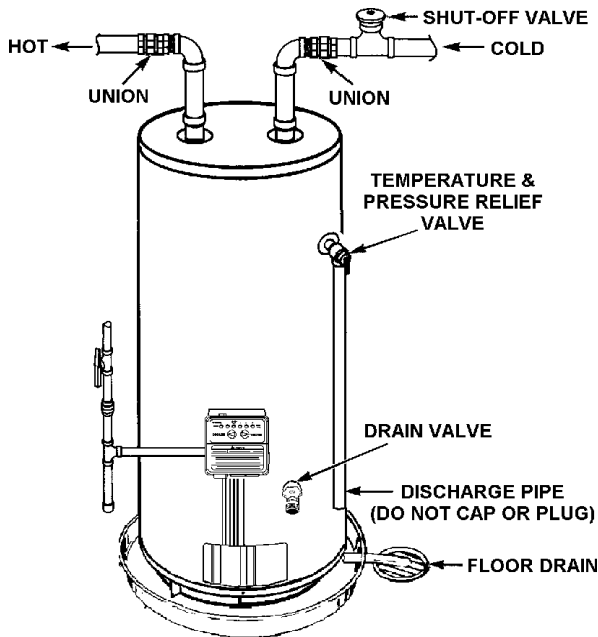

FIGURE 14.

FILLING THE WATER HEATER

CAUTION

Property Damage Hazard

- Avoid water heater damage.
- Fill tank with water before operating.

Never use this water heater unless it is completely full of water. To prevent damage to the tank, the tank must be filled with water. Water must flow from the hot water faucet before turning "ON" gas to the water heater.

To fill the water heater with water:

1. Close the water heater drain valve by turning the handle to the right (clockwise). The drain valve is on the lower front of the water heater.
2. Open the cold water supply valve to the water heater.

NOTE: The cold water supply valve must be left open when the water heater is in use.
3. To insure complete filling of the tank, allow air to exit by opening the nearest hot water faucet. Allow water to run until a constant flow is obtained. This will let air out of the water heater and the piping.
4. Check all water piping and connections for leaks. Repair as needed.

VENT PIPE ASSEMBLY

There are three parts of the vent pipe assembly that connect the water heater exhaust (located on the lower back side of the water heater) to the inlet of the blower assembly (mounted on top of the water heater) as shown in Figure 1. These parts will need to be assembled according to the instructions in the VENT PIPE PREPARATION section of this manual. These PVC parts should be assembled with ASTM D-2564 grade cement.

Assemble Vent Pipe Assemblies #1, #2 and #3 (See Figure 1) prior to cementing. The preferred orientation of Vent Pipe Assembly #1 (Condensate U-Assembly) is shown in Figure 16. However this assembly may be rotated to a different orientation as needed for the specific installation requirements. Note the rotational orientation of each part by marking a line several inches long across the joints. The long tube of Vent Pipe Assembly #2 should be approximately vertical. If it is found that either of the two pieces of pipe in Vent Pipe Assembly #2 are too long for proper fit-up, then remove as little material as possible to improve the fit-up. Keep in mind that the pipes will insert slightly further into the elbows when cement is applied as it acts as a lubricating agent. The vertical distance from the bottom of the Condensate U-Assembly to the floor that supports the water heater should be approximately 0.25" (0.64 cm), see Figure 16. Disassemble the parts and cement back together using the alignment marks. After the cement dries, attach the assembly to the blower and the water heater exhaust using the supplied rubber boots and hose clamps.

A condensate trap is incorporated in the bottom of this vent pipe assembly. See the CONDENSATE section of this manual for further details.

VENTING

⚠ WARNING

Breathing Hazard - Carbon Monoxide Gas

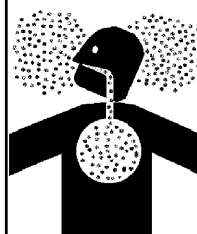

- Install vent system in accordance with codes.
- Do not operate water heater if flood damaged.
- High altitude models should be installed at elevations above 5,300 feet (1,615 m). For operation above 10,100 feet (3,079 m), a high altitude orifice must be installed.
- Do not operate if soot buildup.
- Do not obstruct water heater air intake with insulating jacket.
- Do not place chemical vapor emitting products near water heater.
- Gas and carbon monoxide detectors are available.
- Never operate the heater unless it is vented to the outdoors and has adequate air supply to avoid risks of improper operation, fire, explosion or asphyxiation.
- Analyze the entire vent system to make sure that condensate will not become trapped in a section of vent pipe and therefore reduce the open cross sectional area of the vent.

Breathing carbon monoxide can cause brain damage or death.
Always read and understand instruction manual.

U.S. HORIZONTAL VENT CLEARANCES

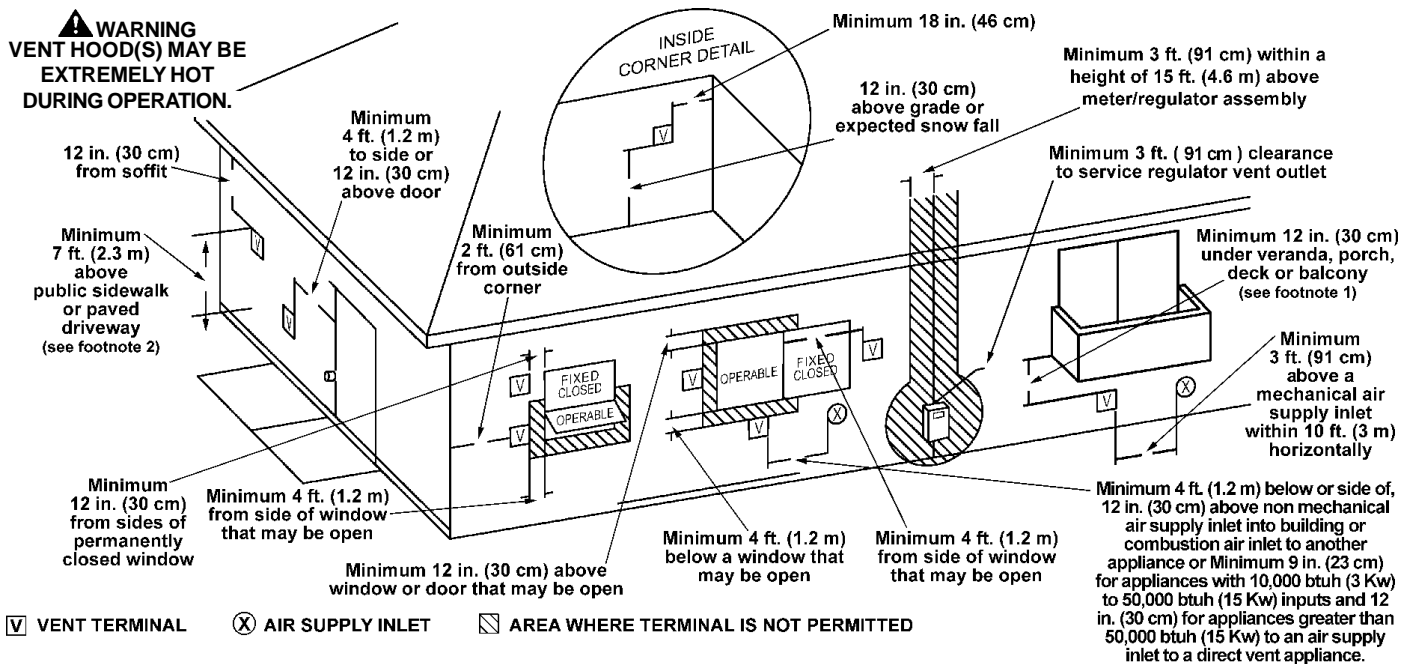

1. Permitted only if veranda, porch, deck or balcony is fully opened on a minimum of two sides beneath the floor.
2. A vent shall not terminate above a sidewalk or paved driveway that is located between two single family dwellings and serves both dwellings.

CANADIAN HORIZONTAL VENT CLEARANCES

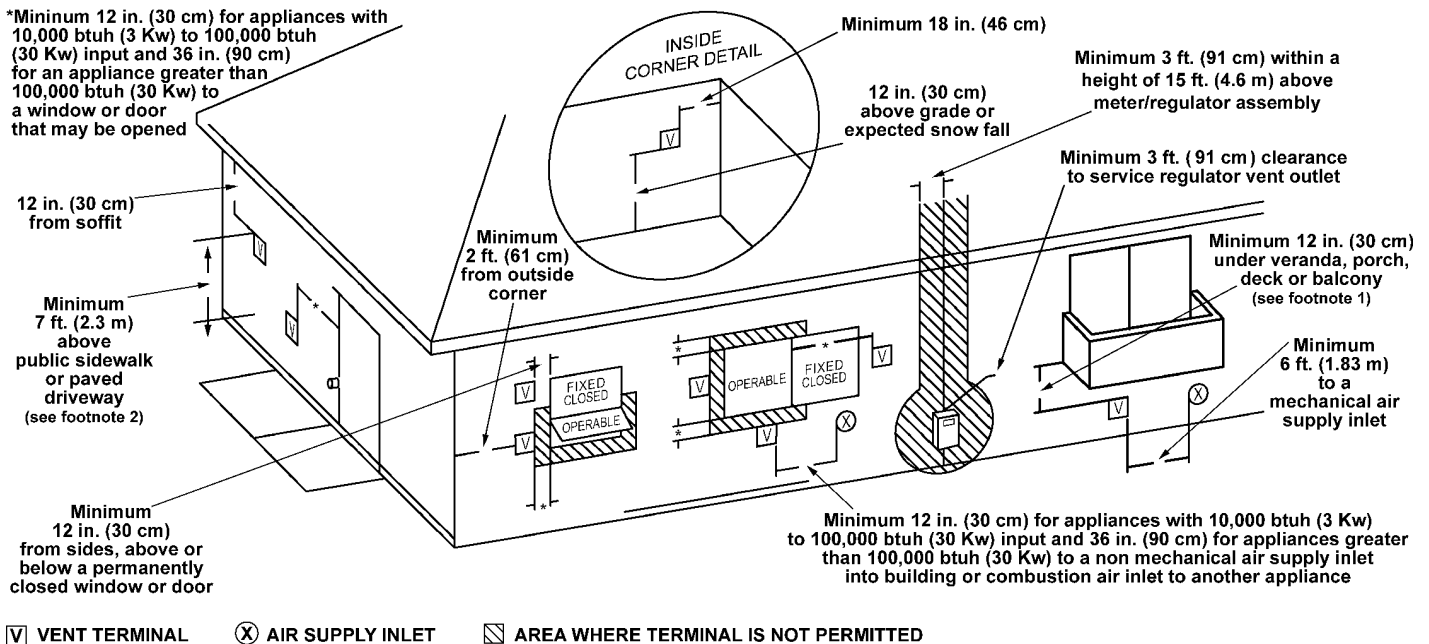

1. Permitted only if veranda, porch, deck or balcony is fully opened on a minimum of two sides beneath the floor.
2. A vent shall not terminate above a sidewalk or paved driveway that is located between two single family dwellings and serves both dwellings.

FIGURE 15

VENT PIPE TERMINATION

The first step is to determine where the vent pipe will terminate. See Figures 15, 20 and 21. The vent may terminate through a sidewall as shown in Figure 20 or through the roof as shown in Figure 21.

The vent system must terminate so that proper clearances are maintained as cited in local codes or the current edition of the National Fuel Gas Code, (ANSI Z223.1, 12.9.1 through 12.9.4) or the Natural Gas and Propane Installation Code (CAN/CSA-B149.1).

Instructions on proper installation through a sidewall are provided in Figure 15.

Plan the vent system layout so that proper clearances are maintained from plumbing and wiring.

Vent pipes serving power vented appliances are classified by building codes as "vent connectors". Required clearances from combustible materials must be provided in accordance with information in this manual under LOCATING THE NEW WATER HEATER and INSTALLING THE WATER HEATER, and with the National Fuel Gas Code and local codes.

PLANNING THE VENT SYSTEM

Plan the route of the vent system from the discharge of the blower to the planned location of the vent terminal.

1. Layout total vent system to use a minimum of vent pipe and elbows.
2. This water heater is capable of venting flue gases equivalent to 25' (7.6 m) of 2" pipe, 65' (19.8 m) of 3" pipe, or 128' (39.0 m) of 4" pipe as listed in Table 1.

TABLE 1

Number of 90° Elbows	2" Maximum Pipe - ft. (m)	3" Maximum Pipe - ft. (m)	4" Maximum Pipe - ft. (m)
1	20 (6.1)	60 (18.3)	120 (36.6)
2	15 (4.6)	55 (16.8)	112 (34.1)
3	10 (3.0)	50 (15.2)	104 (31.7)
4	--	45 (13.7)	96 (29.3)
5	--	40 (12.2)	88 (26.8)
6	--	35 (10.7)	80 (24.3)

The minimum vent lengths for each of the pipe sizes is one 90° on top of the unit plus 2' (61 cm) of straight pipe and the appropriate termination.

NOTE: The equivalent feet (m) of pipe listed above are exclusive of the termination. That is, the termination, with an installed screen, is assumed to be in the system and the remainder of the system must not exceed the lengths discussed above.

3. The blower discharge adapter is made to accept only straight sections of 2" pipe. To start, a minimum of 2 inches (5.1 cm) of 2" pipe must be attached to the blower discharge, see Figure 17.

If using 2" inch vent pipe:

A minimum of 2 inches (5.1 cm) must be attached to the blower before the first elbow. After the first elbow add the additional venting required for the installation. The total system cannot exceed the lengths discussed above, where each elbow is equal to 5 feet (1.5 m) of straight pipe.

If using 3" or 4" inch vent pipe:

Two inches (5.1 cm) of pipe must be attached to the blower discharge before adding a reducer to acquire the desired pipe diameter. An appropriately sized 45 degree elbow (supplied locally-a schedule 40 DWV) vent terminal must be obtained with an equivalent screen (supplied in vent kit). The total system cannot exceed the equivalent pipe lengths discussed above where each elbow is equal to 5 feet (1.5 m) of straight pipe (3" vent pipe) or 8 feet (2.4 m) of straight pipe (4" vent pipe).

U.S. Installations

NOTE: This unit can be vented with PVC pipe materials (Cellular Core ASTM-F891; DWV ASTM-D2665 or CSA B181.2; Schedule 40, 80, 120 ASTM-D1785 or CSA B137.3; or SDR Series ASTM-D2241 or CSA B137.3), CPVC pipe materials (CPVC41 ASTM-D2846 or CSA B137.6; Schedule 40, 80 ASTM-F441 or CSA B137.6; or SDR Series ASTM-F442), ABS pipe materials (Schedule 40 DWV ASTM-D2661 or CSA B181.1 or Schedule 40 DWV Cellular Core ASTM-F628). The fittings, other than the TERMINATION should be equivalent to PVC-DWV fittings meeting ASTM D-2665 (Use CPVC fittings, ASTM F-438 for CPVC pipe and ABS fittings, ASTM D-2661/3311 for ABS pipe). If CPVC or ABS pipe and fittings are used, then the proper cement must be used for all joints, including joining the pipe to the Termination (PVC Material). If local codes do not allow the use of the PVC termination when a material other than PVC is used for venting, then an equivalent fitting of that material may be substituted if the screen in the PVC terminal is removed and inserted into the new fitting.

PVC Materials should use ASTM D-2564 Grade Cement; CPVC Materials should use ASTM F-493 Grade Cement and ABS Materials should use ASTM D-2235 Grade Cement.

Canadian Installation of this water heater must comply with CAN/CSA B149.1 - Natural Gas and Propane Installation Code which requires the vent system components be certified to ULC S636.

This water heater has been design certified to be vented with PVC pipe certified and marked as complying with ULC S636. This water heater is supplied with a 2 inch 22.5 degree termination elbow that is

a special fitting that must be used with this appliance. Any outlet piping, fittings and glue used to vent this appliance that is not supplied by the manufacturer must comply with the ULC S636 requirements.

If the water heater is being installed as a replacement for an existing power vented heater in pre-existing venting, a thorough inspection of the existing venting system must be performed prior to any installation work. Verify that the correct material as detailed above has been used, and that the minimum or maximum vent lengths and terminal location as detailed in this manual have been met. Carefully inspect the entire venting system for any signs of cracks or fractures, particularly at the joints between elbows and other fittings and the straight runs of vent pipe. Check the system for signs of sagging or other stresses in the joints as a result of misalignment of any components in the system. If any of these conditions are found, they must be corrected in accordance with the venting instructions in this manual before completing the installation and putting the water heater into service.

NOTE: A. For water heaters in locations with high ambient temperatures (above 100°F) it is recommended that CPVC or ABS pipe and fittings be used. **B.** A 22.5 degree elbow (2" vent pipe) or a 45 degree elbow (3" and 4" vent pipe) with an installed screen VENT TERMINAL must be used in all cases.

4. There will be some installations where condensate will be formed in the horizontal runs of the vent system. This condensate will run into the condensate boot attached to the blower and out the fitting. The water heater is shipped with condensate hose that attaches to the fitting on the condensate boot. No other Tee or fitting is required. See Figures 17, 20 and 21.

CONDENSATE

This water heater is a condensing unit and requires a drain to be located in close proximity to allow the condensate to drain safely. The condensate drains from the unit at the exhaust tee located at the bottom of the unit (see figure 16) and from two places on the blower assembly (see figure 17). Condensate from this water heater is mildly acidic. Please note that some local codes require that condensate is treated by using a pH neutralizing filter prior to disposal.

NOTE: It is important that the condensate hose on the bottom of the unit is not installed elevated above the clamp that is secured to the side of the jacket, see figure 16. This must be true for the entire length of the hose from the clamp to the exit into an appropriate drain. If these instructions are not followed or if the condensate hose is blocked, water will spill from the condensate trap. As with every water heater installation, a drain pan should be used to prevent water damage to the surrounding area. If necessary, a condensate pump with an incorporated reservoir may be used to pump the water to an appropriate drain. To avoid condensate spillage, select a pump with an overflow switch.

Caution must be used to ensure that the drain is free and clear of debris and will not allow backflow through the condensate hose. Consideration must be given to avoid freezing of the condensate lines which could result in excessive build up of condensate inside the water heater. Waterproof heat tape may be required to prevent freezing of the condensate lines. Please ensure that the outlet of the condensate drain does not create a slippery condition which could lead to personal injury.

⚠ WARNING

Breathing Hazard - Carbon Monoxide Gas

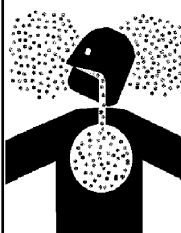

- Form an approximately 8" diameter loop in the condensate hoses on top of the water heater to trap water and prevent the escape of combustion by-products.
- Do not elevate the condensate hose on the bottom of the water heater above the bracket attached to the side of the unit. This must be true for the entire length of the hose including the exit into an appropriate drain.
- Condensate lines must be free and clear of debris and must not allow back flow through the hose. The condensate lines must be able to flow freely to an appropriate drain.
- Do not allow condensate lines to become crimped closed.
- Analyze the entire vent system to make sure that condensate will not become trapped in a section of vent pipe and therefore reduce the open cross sectional area of the vent.

Breathing carbon monoxide can cause brain damage or death.
Always read and understand instruction manual.

The condensate trap may be primed by filling the CONDENSATE U-ASSEMBLY with tap water using the supplied hose while the water heater is not operating. The system is fully primed when the hose is lowered below the hose clamp on the side of the water heater and water begins to flow out of the hose. In most installations the water heater will self-prime the condensate trap during the first full heat-up cycle. If a sound of air bubbling through water (gurgling) is heard while the blower is operating after the first heat-up cycle, then turn the unit off and contact your plumber or service representative.

If these instructions are not followed, the condensate build-up will block the exhaust outlet, which will cause improper operation.

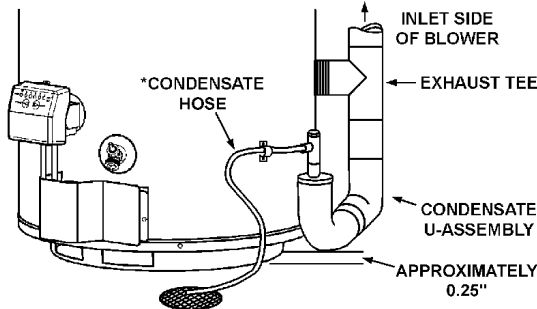

*NOTE: NO PORTION OF THE CONDENSATE HOSE MAY BE ELEVATED HIGHER THAN THE CLAMP THAT IS SECURED TO THE SIDE OF THE JACKET THROUGHOUT THE ENTIRE LENGTH OF THE HOSE INCLUDING THE EXIT INTO AN APPROPRIATE DRAIN.

CONDENSATE SYSTEM - FIGURE 16

Condensate is likely to form in the venting system attached to this water heater. The vent pipe should be sloped downward away from the blower assembly (not less than 1/8" (3.2 mm) nor greater than 1/2" (12.7 mm) per foot (30 cm) maximum). If the vent piping is vented level or sloped upwards away from the blower assembly, then adequate means for draining and disposing of the condensate needs to be made by the installer. In either case, a 3/8" drain hose should be connected to the built-in drain port. Prior to operating the water heater, make sure the removable cap is installed on the second drain port, see Figure 17.

BLOWER ASSEMBLY INSTALLATION

1. This power vented water heater comes with the blower assembly installed.
2. After the unit is set in place, make sure the blower assembly is still mounted securely. Also make sure that one of the drain ports of the rubber boot vent adapter is capped off. Lastly, make sure there is no damage to the blower.
3. Condensate drains from two locations on the blower assembly as shown in figure 17. A condensate hose must be secured to form a "trap" as shown in figure 17 for these condensate drain connections. These two hoses may be connected together. The hose(s) should be routed to a suitable drain. A fitting that may be used to join the two hoses from the blower assembly is included in a supplied kit.

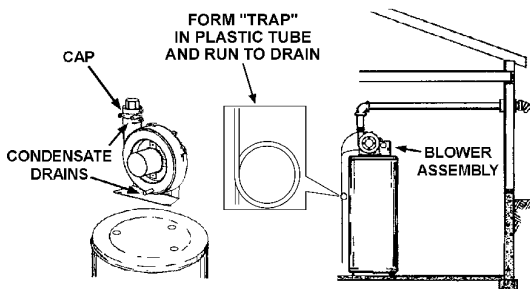

FIGURE 17.

4. Make sure there is no packing material in the inlet or discharge of the blower.
5. Make sure that the plastic tubing is still attached from the air pressure switch to the port on the blower housing. Make sure the plastic tubing is not folded anywhere between the pressure switch and the blower housing.

6. Make sure the ON/OFF switch is in the OFF position and that the outer harness is connected from the blower control box to the connector on the bottom side of the gas valve.
7. If the outer harness is not factory installed, make sure the ON/OFF switch is in the OFF position and then connect the outer harness from the blower control box to the connector on the bottom side of the gas valve.

⚠ **WARNING**

- Before servicing the water heater, make sure the blower assembly is unplugged and the electrical supply to the water heater is turned "OFF".
- Label all wires prior to disconnection when servicing controls. Wiring error can cause improper and dangerous operation. Verify proper operation after servicing.
- Failure to do this could result in death, serious bodily injury, or property damage.

8. Do not plug in power cord until vent system is completely installed. The Power Vent operates on 110-120 Vac. therefore a grounded outlet must be within reach of the 6 foot (1.8 m) flexible power cord supplied with the vent (See Figure 1). The power cord supplied may be used on a unit only where local codes permit. If local codes do not permit use of flexible power supply cord:
 - A. Make sure the unit is unplugged from the wall outlet. Remove the plastic top cap. Remove screws and open panel on the front of the control box on the blower.
 - B. Cut the flexible power cord, leaving enough to be able to make connections. Remove the strain relief fitting from the box.
 - C. Install a suitable conduit fitting inside the enclosure.
 - D. Splice field wiring into existing wiring using code authorized method (wire nuts, etc).
 - E. Be certain that neutral and line connections are not reversed when making these connections.
 - F. Ground heater properly. This water heater must be grounded in accordance with the National Electrical Code NFPA 70 or the Canadian Electrical Code C22.1 and/or local codes. These must be followed in all cases.

The water heater must be connected to a grounded metal, permanent wiring system; or an equipment grounding conductor must be run with the circuit conductors and connected to the equipment grounding terminal or lead on the water heater, see Figure 19.

- G. Close the panel on the control box. Make sure that the access panel is secured shut.
9. The blower discharge boot is made to accept only straight sections of 2" pipe. To start off with an elbow, a short section of the furnished pipe, a minimum of 2 inches (5.1 cm), must be cut and glued into the end of the elbow that will mount on the discharge boot.

INSTALLATION OF VENT SYSTEM

Before beginning installation of piping system thoroughly read the section of this manual VENT PIPE PREPARATION.

If you are installing your system so that it vents through roof, please refer to section titled INSTALLATION OF VERTICAL VENT SYSTEM.

VENT TERMINAL INSTALLATION, SIDEWALL

1. Install the vent terminal by using the cover plate as a template to mark the hole for the vent pipe to pass through the wall. BEWARE OF CONCEALED WIRING AND PIPING INSIDE THE WALL.

2. If the Vent Terminal is being installed on the outside of a finished wall, it may be easier to mark both the inside and outside wall. Align the holes by drilling a hole through the center of the template from the inside through to the outside. The template can now be positioned on the outside wall using the drilled hole as a centering point for the template.

3. A) MASONRY SIDE WALLS
Chisel an opening approximately one half inch (1.3 cm) larger than the marked circle.

B) WOODEN SIDE WALLS

Drill a pilot hole approximately one quarter inch (0.64 cm) outside of the marked circle. This pilot hole is used as a starting point for a saws-all or sabre saw blade. Cut around the marked circle staying approximately one quarter inch (0.64 cm) outside of the line. (This will allow the vent to easily slide through the opening. The resulting gap will be covered up by the Vent Terminal cover plate.) Repeat this step on inside wall if necessary.

SEQUENCE OF INSTALLATIONS, FIGURE 18

Cut a length of PVC pipe about 3.5 inches (8.9 cm) longer than the wall thickness at the opening. Glue the vent terminal to this section of pipe. Slide

the wall plate over the pipe to stop against the vent terminal. Place a bead of caulking (not supplied) around the gap between the pipe and cover plate. Apply enough to fill some of the gap between the pipe and wall. Place some of the caulking on the back of the plate to hold it against the wall after installation. If the vent pipe is installed up to the wall, with a coupling on the end against the wall opening, the pipe with the vent terminal can be prepared for gluing before inserting through the wall. Slide the pipe through the wall and insert into the coupling on the other side of the wall, making sure that the vent terminal ends up pointed in the correct position, see Figure 18.

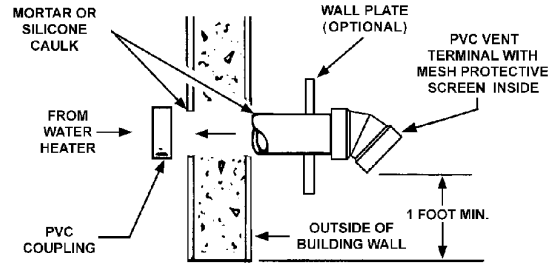

VENT TERMINATION - FIGURE 18.

CAUTION

LABEL ALL WIRES PRIOR TO DISCONNECTION WHEN SERVICING CONTROLS. WIRING ERRORS CAN CAUSE IMPROPER AND DANGEROUS OPERATION. VERIFY PROPER OPERATION AFTER SERVICING.

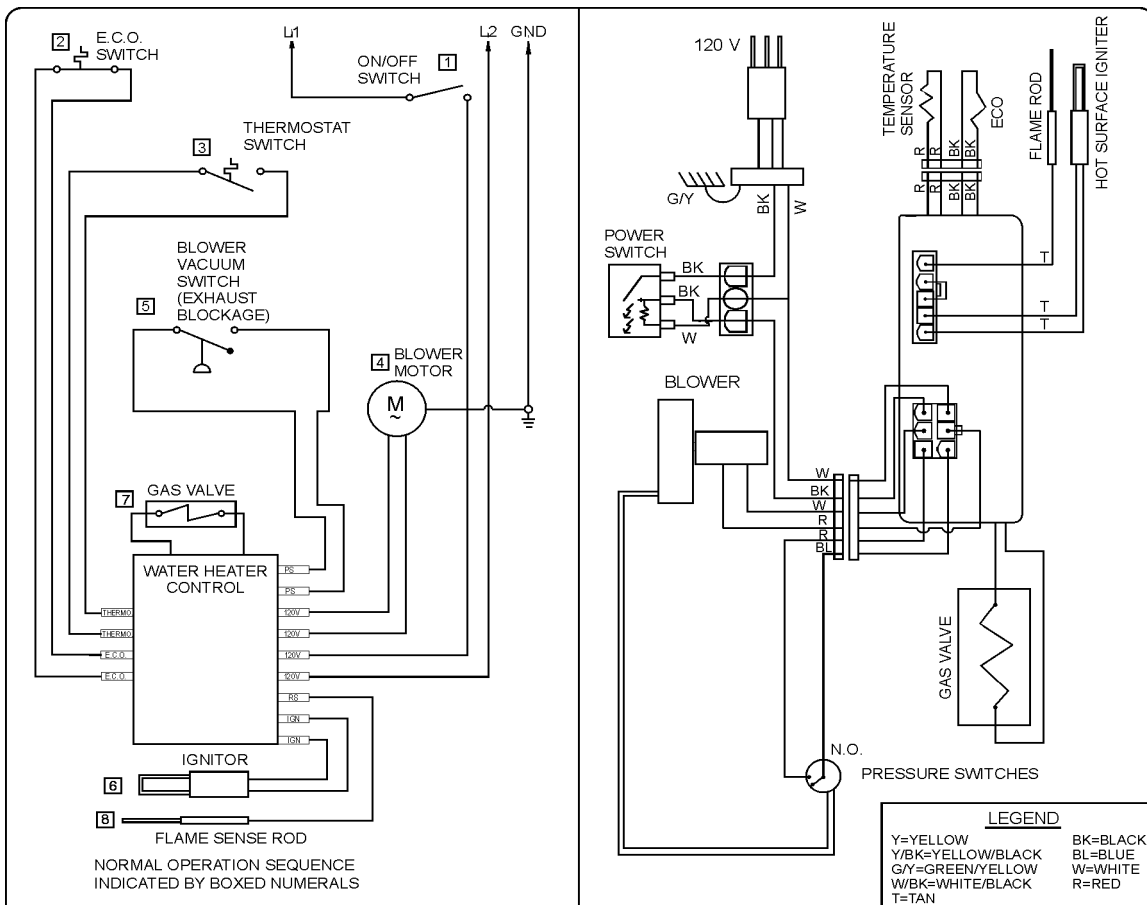

WARNING

DISCONNECT FROM ELECTRICAL SUPPLY BEFORE SERVICING UNIT.
REPLACE ALL DOORS AND PANELS BEFORE OPERATING HEATER.

IF ANY OF THE ORIGINAL WIRES SUPPLIED WITH THE APPLIANCE MUST BE REPLACED, IT MUST BE REPLACED WITH APPLIANCE WIRE MATERIAL WITH MINIMUM TEMPERATURE RATING OF 105°C AND A MINIMUM SIZE OF NO. 18 AWG.

POWER VENT WIRING SCHEMATIC - FIGURE 19.

INSTALLATION OF VENT SYSTEM, SIDEWALL

With the route of the venting system and selection of materials completed, as discussed in the section of this manual titled PLANNING THE VENT SYSTEM, the through the wall vent terminal in place and the first section of piping, up to first elbow, installed at the blower it is time to complete the installation of the venting system for the sidewall installation.

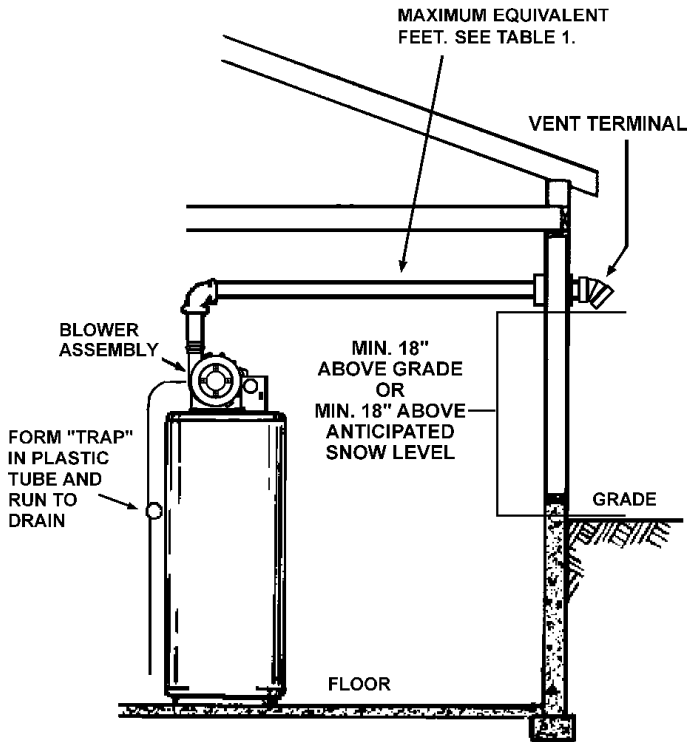

FIGURE 20

Before completing the installation of the venting system be sure to read the sections of this manual discussing the proper method of cutting and cementing PVC pipe and fittings: VENT PIPE PREPARATION.

It is recommended that the completion of the venting system start at the blower assembly and run to the coupling on the inside wall of the vent terminal, Figure 18.

The vent system piping should be supported every 5 feet (1.5 m) of vertical run and every 3 feet (91 cm) of horizontal run. All piping and fittings must be joined by the proper procedures as described under: VENT PIPE PREPARATION.

INSTALLATION OF VERTICAL VENT SYSTEM

A proper flashing or "BOOT" should be used to seal the pipe where

it exits the roof. The total vent system should not exceed the equivalent feet of pipe as listed in Table 1.

Provide support for all pipe protruding through the roof. All piping should be properly secured. The vent system piping should be supported every 5 feet (1.5 m) of vertical run and every 3 feet (91 cm) of horizontal run. All piping and fittings must be joined by the proper procedures as described under: VENT PIPE PREPARATION.

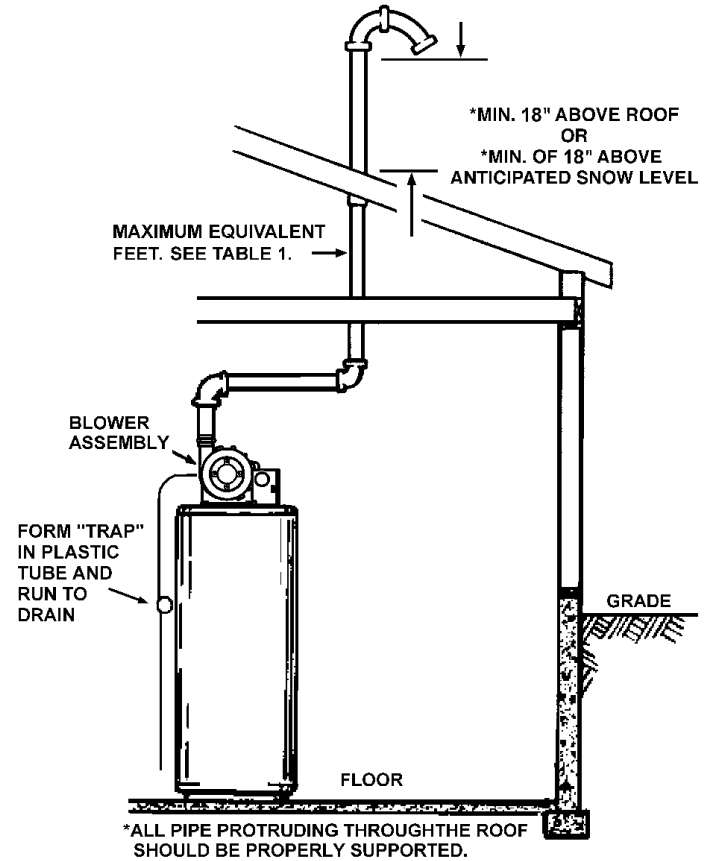

FIGURE 21

IMPORTANT

The vent system must terminate so that proper clearances are maintained as cited in local codes or the current edition of the National Fuel Gas Code (ANSI Z223.1) or the Natural Gas and Propane Installation Code (CAN/CSA-B149.1) and as listed below:

1. Vent Termination must extend a minimum of 18 inches (46 cm) above roof or 18 inches (46 cm) above the anticipated snow level to prevent blockage of the vent termination, as shown in Figures 20 and 21.

VENT ATTENUATION ASSEMBLY INSTALLATION INSTRUCTIONS

The Vent Attenuation Assembly (VAA) is designed to provide a reduction in fan noise created in the blower wheel. This installation of this VAA is optional. Review directions thoroughly prior to installing the new VAA. Please contact the manufacturer of the water heater as shown in the instruction manual with any questions or for additional product support.

VENT ATTENUATION ASSEMBLY KIT PARTS LIST

The kit consists of the following items. If a part is missing, use the contact information in the instruction manual to acquire missing component(s).

- vent attenuation assembly
- flexible tubing
- hose barb
- hex plug (installed on VAA)
- instruction sheet

VENT ATTENUATION ASSEMBLY INSTALLATION

The VAA is designed for both vertical and horizontal installations. The vertical installation does not require the additional hose barb and flexible tubing. However, the horizontal installation will require the hose barb and flexible tubing to release condensate buildup from the VAA. See instructions and diagrams that follow for a more detailed description.

⚠ WARNING

Breathing Hazard - Carbon Monoxide Gas

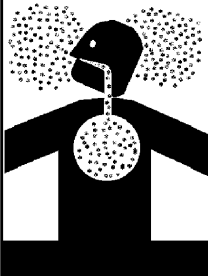

- Form an approximately 8" diameter loop in the condensate hoses on top of the water heater to trap water and prevent the escape of combustion by-products.
- Condensate lines must be free and clear of debris and must not allow back flow through the hose. The condensate lines must be able to flow freely to an appropriate drain.
- Do not allow condensate lines to become crimped closed.
- Analyze the entire vent system to make sure that condensate will not become trapped in a section of vent pipe and therefore reduce the open cross sectional area of the vent.

Breathing carbon monoxide can cause brain damage or death.
Always read and understand instruction manual.

Vertical VAA Installations (Recommended)

1. The VAA is designed to accept two inch PVC pipe into the adapters on both ends. The VAA can be installed to the piping from either side (there is no specific inlet or outlet). For optimum performance, install VAA as close as possible to the blower assembly.
2. Use standard PVC cement (not included with kit) and glue the two inch PVC pipe coming from the blower into the VAA.
3. Perform the same sequence on the PVC pipe coming from the exhaust side (vent terminal side) of the VAA.
4. Make sure the VAA and vent pipe is supported securely to a permanent fixture (stud or wall). Use standard support straps (not supplied with kit) that may be found at a local hardware store. Failure to properly

support the VAA and the surrounding vent pipe could create a hazardous situation. DO NOT puncture any surface of the VAA.

5. Confirm that the hex plug is securely installed in the 1/2" fitting found on the center of the VAA pipe. It is imperative that the plug is secure and air tight to prevent any combustion gases escaping into the room. If the plug is not securely tightened, remove and reinstall using Teflon tape on the threads. Once installed along with the rest of the vent configuration, make sure to operate the unit through at least one heat up cycle to ensure there is no leakage around the plug or any joints of the VAA or vent pipe system.

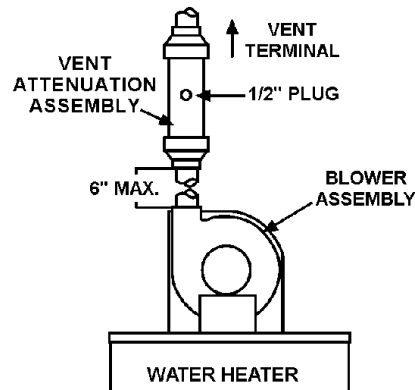

FIGURE 22: Typical Vertical Installation

Horizontal VAA Installations

1. The VAA is designed to accept two inch PVC pipe into the adapters on both ends. The VAA can be installed to the piping from either side (there is no specific inlet or outlet). For optimum performance, install VAA as close as possible to the blower assembly.
2. Use standard PVC cement (not included with kit) and glue the two inch PVC pipe coming from the blower into the VAA. Make sure the 1/2" fitting is on the bottom side of the VAA. This will be used to run the condensate hose to a suitable drain. See typical vent installation in Figure 23.
3. Perform the same sequence on the PVC pipe coming from the exhaust side (vent terminal side) of the VAA.
4. Make sure the VAA and vent pipe is supported securely to a permanent fixture (stud or wall). Use standard support straps (not supplied with kit) that may be found at a local hardware store. Failure to properly support the VAA and the surrounding vent pipe could create a hazardous situation. DO NOT puncture any surface of the VAA.
5. Remove hex plug from the center pipe of the VAA. Locate the hose barb and install into the 1/2" fitting on the center of the VAA. Using Teflon tape on the threads, install hose barb into 1/2" fitting securely. It is imperative that the hose barb is secure and tight to prevent any combustion gases escaping into the room.
6. Locate flexible tubing. Slide one end of tube over the hose barb located on the center pipe of the VAA. The ridges on the hose barb should prevent the tube from sliding off, however, to ensure there are no leaks and possible dislocation from hose barb, use a wire tie or hose clamp (not supplied with kit) and secure.
7. Take the other end of the flexible tubing and form an 8 inch (20 cm) diameter circle approximately 3 feet (91 cm) down from the hose barb located in the VAA. To ensure that the circle (loop) maintains its shape, use two wire ties (not supplied with kit) to secure it.

8. Take the end of the tube at the bottom of the floor and route it to a suitable drain. This will provide an area where the condensate can drain without affecting the area around the appliance.
9. Once installed along with the rest of the vent configuration, make sure to operate the unit through at least one heat up cycle to ensure there is no leakage around the hose barb or any joints of the VAA or vent pipe system.

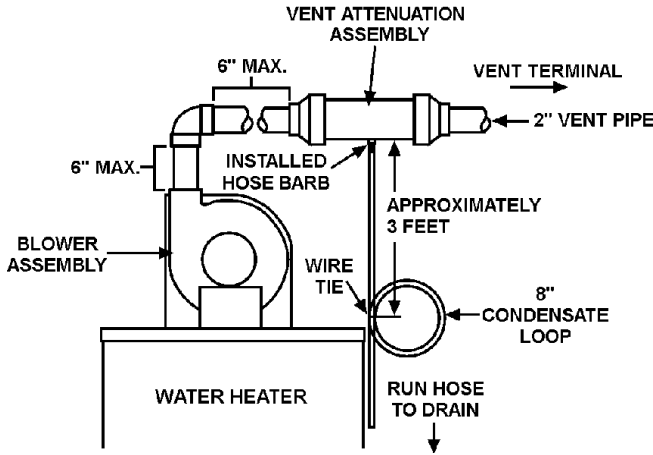

FIGURE 23: Typical Horizontal Installation

Installation for VAA with 3 & 4 inch Pipe for Vertical Vent

Some applications may require the use of 3 or 4 inch vent pipe for longer vent lengths. Please refer to the Figure 24 as you review these instructions. Refer back to the vertical VAA installation steps but with the following changes to the vent construction.

3 inch vent (Vertical VAA Installations)

The VAA is designed to accommodate only 2 inch vent pipe. The installer must use 2 inch vent pipe between the blower assembly and the inlet into the VAA. On the outlet side of the VAA, a short run of 2 inch vent pipe is required. Each of the short pieces of 2 inch pipe entering and exiting the VAA must not exceed 6 inches (15 cm) in length. From this point on, a 2 inch to 3 inch adapter may be used. From the 2 inch to 3 inch adapter, the installer may use up to 65 equivalent feet (19.8 m) of pipe, see Figure 24 for typical installation.

4 inch vent (Vertical VAA Installations)

The VAA is designed to accommodate only 2 inch vent pipe. The installer must use 2 inch vent pipe between the blower assembly and the inlet into the VAA. On the outlet side of the VAA, a short run of 2 inch vent pipe is required. Each of the short pieces of 2 inch pipe entering and exiting the VAA must not exceed 6 inches (15 cm) in length. From this point on, a 2 inch to 4 inch adapter may be used. From the 2 inch to 4 inch adapter, the installer may use up to 128 equivalent feet (39.0 m) of pipe, see Figure 24 for typical installation.

Remember to operate the unit for at least one heat cycle to ensure there are no air leaks in the vent joints of the VAA and the vent pipe system. Air leaks will allow flue gas by-products to disseminate into the room creating an unsafe environment and could cause illness, asphyxiation and/or even death.

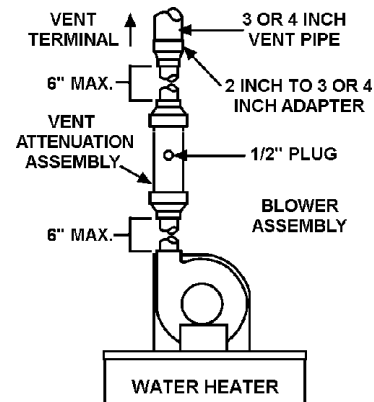

FIGURE 24: Typical Installation for Vertical Vent with 3 or 4 inch Pipe

Installation of VAA with 3 & 4 inch Pipe for Horizontal Vent

Some applications may require the use of 3 or 4 inch vent pipe for longer vent lengths. Please refer to the Figure 25 as you review these instructions. Refer back to the horizontal VAA installation steps but with the following changes to the vent construction.

3 inch vent (Horizontal VAA Installations)

The VAA is designed to accommodate only 2 inch vent pipe. The installer must use 2 inch vent pipe between the blower assembly and the inlet into the VAA. On the outlet side of the VAA, a short run of 2 inch vent pipe is required. From this point on, a 2 inch to 3 inch adapter may be used. From the 2 inch to 3 inch adapter, the installer may use up to 52 equivalent feet (15.8 m) of pipe. This is 8 equivalent feet (2.4 m) less than the original 60 equivalent feet (18.3 m) specified with one elbow due to the 2 inch elbow instead of a 3 inch elbow required for the vent from the blower to the inlet of the VAA, see Figure 25 for typical installation.

4 inch vent (Horizontal VAA Installations)

The VAA is designed to accommodate only 2 inch vent pipe. The installer must use 2 inch vent pipe between the blower assembly and the inlet into the VAA. On the outlet side of the VAA a short run of 2 inch vent pipe is required. From this point on, a 2 inch to 4 inch adapter may be used. From the 2 inch to 4 inch adapter, the installer may use up to 102 equivalent feet (31.1 m) of pipe. This is 18 equivalent feet (5.5 m) less than the original 120 equivalent feet (36.6 m) specified with one elbow due to the 2 inch elbow instead of a 4 inch elbow required for the vent from the blower to the inlet of the VAA, see Figure 25 for typical installation.

Remember to operate the unit for at least one heat cycle to ensure there are no air leaks in the vent joints of the VAA and the vent pipe system. Air leaks will allow flue gas by-products to disseminate into the room creating an unsafe environment and could cause illness, asphyxiation and/or even death.

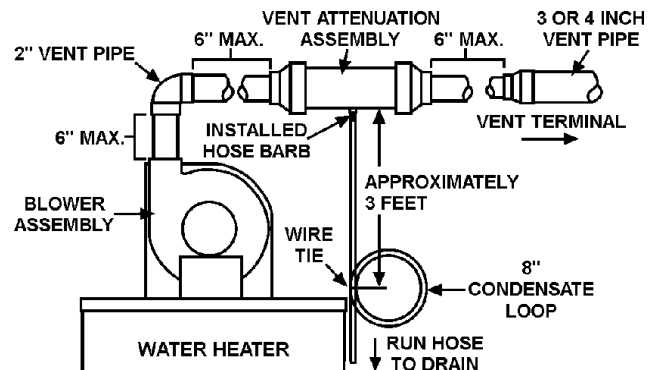

FIGURE 25: Typical Installation for Horizontal Vent with 3 or 4 inch

VENT PIPE PREPARATION

1. INITIAL PREPARATION

- A. Make sure the solvent cement you are planning to use is designed for the specific application you are attempting.
- B. Know the physical and chemical characteristics and limitations of the PVC and CPVC piping materials that you are about to use.
- C. Know the reputation of your manufacturer and their products.
- D. Know your own qualifications or those of your contractor. The solvent welding technique of joining PVC and CPVC pipe is a specialized skill just as any other pipe fitting technique.
- E. Closely supervise the installation and inspect the finished job before start-up.
- F. Contact the manufacturer, supplier, or competent consulting agency if you have any questions about the application or installation of PVC and CPVC pipe.
- G. Take the time and effort to do a professional job. Shortcuts will only cause you problems and delays in start-up. By far, the majority of failures in PVC and CPVC systems are the result of shortcuts and/or improper joining techniques.

2. SELECTION OF MATERIALS

- Cutting Device - Saw or Pipe Cutter
- Deburring Tool, Knife, File, or Beveling Machine (2" and above)
- Brush - Pure Bristle
- Rag - Cotton (Not Synthetic)
- Primer and Cleaner
- Solvent Cement - PVC for PVC Components and CPVC for CPVC Components
- Containers - Metal or Glass to hold Primer and Cement. Select the type of PVC or CPVC materials to be used on the basis of their application with respect to chemical resistance, pressure rating, temperature characteristics, etc.
- Insertion Tool - Helpful for larger diameter pipe and fittings 6 inches (15.2 cm) and above.

⚠ WARNING

Fire or Explosion Hazard

- Do not store or use gasoline or other flammable vapors and liquids in the vicinity of this or any other appliance.
- Avoid all ignition sources if you smell LP gas.
- Do not expose water heater control to excessive gas pressure.
- Use only gas shown on rating plate.
- Maintain required clearances to combustibles.
- Keep ignition sources away from faucets after extended period of non-use.



Read instruction manual before installing, using or servicing water heater.



PRIMER

It is recommended that Tetrahydrofuran (THF) be used to prepare the surfaces of pipe and fittings for solvent welding. Do not use water, rags, gasoline or any other substitutes for cleaning PVC or CPVC surfaces. A chemical cleaner such as MEK may be used.

CEMENT

The cement should be a bodied cement of approximately 500 to 1600 centipoise viscosity containing 10-20% (by weight) virgin PVC material solvated with tetrahydrofuran (THF). Small quantities of dimethyl formamide (DMF) may be included to act as a retarding agent to extend curing time. Select the proper cement; Schedule 40 cement should be used for Schedule 40 pipe. Never use all-purpose cements, commercial glues and adhesives or ABS cement to join PVC or CPVC pipe and fittings.



⚠ WARNING

Fire Hazard

- Primers and cements are extremely flammable, and must not be stored or used near heat or open flame.
- Also, use only in a well ventilated area.

APPLICATORS

Select a suitable pure bristle type paint brush. Use a proper width brush or roller to apply the primer and cement (see chart below). Speedy application of cement is important due to its fast drying characteristics. **IMPORTANT NOTE:** A dauber type applicator should only be used on pipe sizes 2" and below. For larger diameter pipe, a brush or roller must be used.

RECOMMENDED BRUSH* SIZE FOR PRIMER AND CEMENT APPLICATIONS	
Nominal Pipe (IPS)	Size Brush Width
2	1.5" (3.8 cm)
3	1.5" - 2.5" (3.8 cm - 6.4 cm)

***USE ONLY NATURAL BRISTLE**

3. MAKING THE JOINT

A. Cutting

Pipe must be squarely cut to allow for the proper interfacing of the pipe end and the fitting socket bottom. This can be accomplished with a miter box saw or wheel type cutter. Wheel type cutters are not generally recommended for larger diameters since they tend to flare the corner of the pipe end. If this type of cutter is used, the flare on the end must be completely removed.

NOTE: Power saws should be specifically designed to cut plastic pipe.

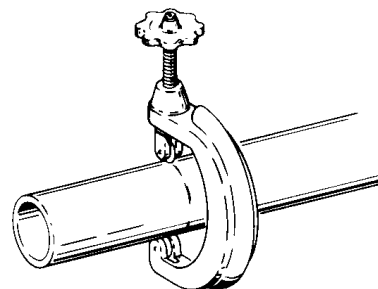

STEP A

B. Deburring

Use a knife, plastic pipe deburring tool, or file to remove burrs from the end of small diameter pipe. Be sure to remove all burrs from around the inside as well as the outside of the pipe. A slight chamfer (bevel) of about 10°-15° should be added to the end to permit easier insertion of the pipe into the end of the fitting. Failure to chamfer the edge of the pipe may remove cement from the fitting socket, causing the joint to leak.

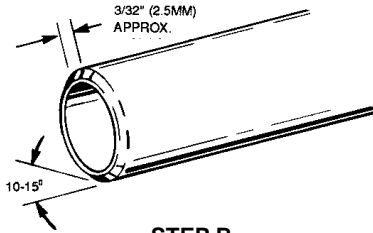

C. Test dry fit of the joint

Tapered fitting sockets are designed so that an interfaced fit should occur when the pipe is inserted about 1/3 to 2/3 of the way into the socket. Occasionally, when pipe fitting dimensions are at the tolerance extremes, it will be possible to fully insert dry pipe to the bottom of the fitting socket. When this happens, a sufficient quantity of cement must be applied to the joint to fill the gap between the pipe and fitting. The gap must be filled to obtain a strong, leak-free joint.

D. Inspection, cleaning, priming

Visually inspect the inside of the pipe and fitting sockets and remove all dirt, grease or moisture with a clean dry rag. If wiping fails to clean the surfaces, a chemical cleaner must be used. Check for possible damage such as splits or cracks and replace if necessary.

Depth-of-entry

Marking the depth of entry is a way to check if the pipe has reached the bottom of the fitting socket in Step F. Measure the fitting depth and mark this distance on the pipe O.D. You may want to add several inches to the distance and make a second mark as the primer and cement will most likely destroy your first one.

Apply primer to the surface of the pipe and fitting socket with a natural bristle brush. This process softens and prepares the PVC or CPVC for the solvent cementing step. Move quickly and without hesitation to the cementing procedure while the surfaces are still wet with primer.

E. Application of solvent cement

- Apply the solvent cement evenly and quickly around the outside of the pipe at a width a little greater than the depth of the fitting socket.
- Apply a light coat of cement evenly around the inside of the fitting socket. Avoid puddling.
- Apply a second coat of cement to the pipe end.

	<p>▲ WARNING</p> <ul style="list-style-type: none">• Cans of cement and primer should be closed at all times when not in use to prevent evaporation of chemicals and hardening of cement.• They are also very flammable and should be kept away from heat or flame.
---	---

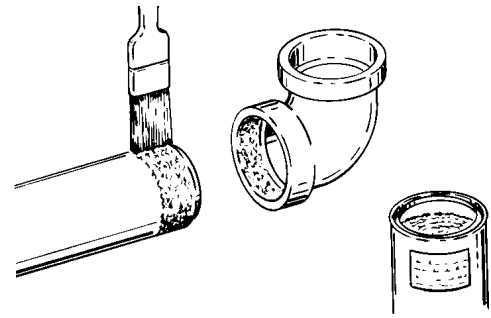

F. Joint assembly

Working quickly, insert the pipe into the fitting socket bottom and give the pipe or fitting a 1/4 turn to evenly distribute the cement. Do not continue to rotate the pipe after it has hit the bottom of the fitting socket. A good joint will have sufficient cement to make a bead all the way around the outside of the fitting hub. The fitting will have a tendency to slide back while the cement is still wet so hold the joint together for about 15 seconds.

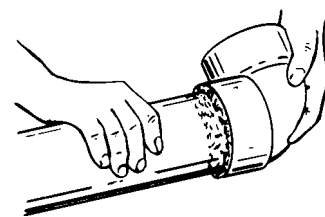

G. Cleanup and joint movement

Remove all excess cement from around the pipe and fitting with a dry cotton rag. This must be done while the cement is still soft.

The joint should not be disturbed immediately after the cementing procedure, and sufficient time should be allowed for proper curing of the joint. Exact drying time is difficult to predict because it depends on variables such as temperature, humidity and cement integrity. For more specific information, you should contact your solvent cement manufacturer.

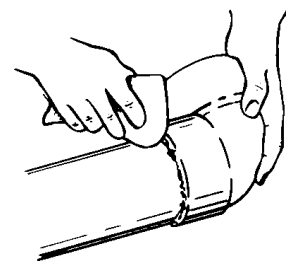

FOR YOUR SAFETY READ BEFORE OPERATING



WARNING: If you do not follow these instructions exactly, a fire or explosion may result causing property damage, personal injury or loss of life.



BEFORE OPERATING: ENTIRE SYSTEM MUST BE FILLED WITH WATER AND AIR PURGED FROM ALL LINES.

- A. This appliance does not have a pilot. It is equipped with an ignition device which automatically lights the burner. **Do NOT try to light the burner by hand.**
- B. **BEFORE OPERATING** smell all around the appliance area for gas. Be sure to smell next to the floor because some gas is heavier than air and will settle on the floor.
- WHAT TO DO IF YOU SMELL GAS:**
- Do not try to light any appliance.
 - Do not touch any electric switch; Do not use any phone in your building.
 - Immediately call your gas supplier from a neighbor's phone. Follow the gas supplier's instructions.
- If you cannot reach your gas supplier, call the fire department.
- C. Use only your hand to push in the gas control buttons. Never use tools. If the control buttons will not push in, don't try to repair them, call a qualified service technician. Force or attempted repair may result in a fire or explosion.
- D. Do not use this appliance if any part has been under water. Immediately contact a qualified installer or service agency to replace a flooded water heater. Do not attempt to repair the unit! It must be replaced!

OPERATING INSTRUCTIONS

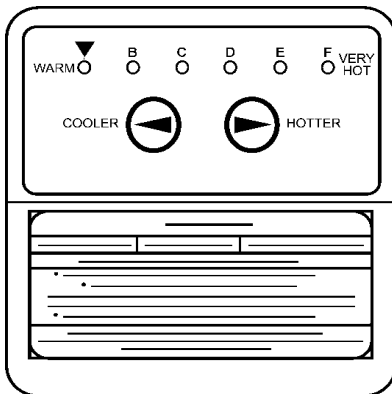

1. STOP! Read the safety information above, on this label.
2. Set the thermostat to the lowest setting by first pressing the COOLER and HOTTER buttons together and holding for 1 second. Then press the COOLER button until the WARM indicator light appears.
3. Set the "ON/OFF" switch on the blower control box to the "OFF" position.

4. This appliance is equipped with a device which automatically lights the burner. **DO NOT TRY TO LIGHT THE BURNER BY HAND.**
5. Wait five (5) minutes to clear out any gas. If you then smell gas, STOP! Follow "B" in the safety information above on this label. If you don't smell gas, go to the next step.
6. Turn on all electrical power to the appliance.
7. Set thermostat to desired setting by first pressing the COOLER and HOTTER buttons together and holding for 1 second. Then press the HOTTER button.
8. If the appliance will not operate, follow the instructions "TO TURN OFF GAS TO APPLIANCE" and call your technician or gas supplier.
9. **WATER TEMPERATURE ADJUSTMENT**
▼ is approximately 120°F.



CAUTION: Hotter water increases the risk of scald injury. Consult the instruction manual before changing temperature.



WARNING: TURN OFF ALL ELECTRIC POWER BEFORE SERVICING

TO TURN OFF GAS TO APPLIANCE

1. Set the thermostat to the lowest setting by first pressing the COOLER and HOTTER buttons together and holding for 1 second. Then press the COOLER button until the WARM indicator light appears.
2. Set the ON/OFF switch on the blower control box to the "OFF" position.
3. Turn off all electric power to the appliance if service is to be performed.

TEMPERATURE REGULATION

It is recommended that lower water temperatures be used to avoid the risk of scalding. It is further recommended, in all cases, that the water temperature be set for the lowest temperature which satisfies your hot water needs. This will also provide the most energy efficient operation of the water heater.

Short repeated heating cycles caused by small hot water uses can cause temperatures at the point of use to exceed the thermostat setting by up to 20°F (11°C). If you experience this type of use you should consider using lower temperature settings to reduce scald hazards.

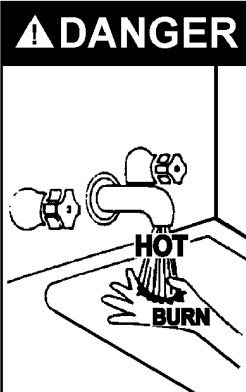

▲ DANGER Water temperature over 125°F (52°C) can cause severe burns instantly resulting in severe injury or death.

Children, the elderly, and the physically or mentally disabled are at highest risk for scald injury.

Feel water before bathing or showering.

Temperature limiting valves are available.

Read instruction manual for safe temperature setting.

HOT WATER CAN SCALD: Water heaters are intended to produce hot water. Water heated to a temperature which will satisfy space heating, clothes washing, dish washing, and other sanitizing needs can scald and permanently injure you upon contact. Some people are more likely to be permanently injured by hot water than others. These include the elderly, children, the infirm, or physically/mentally handicapped. If anyone using hot water from this heater fits into one of these groups or if there is a local code or state law requiring a certain temperature water at the hot water tap, then you must take special precautions. In addition to using the lowest possible temperature setting that satisfies your hot water needs, a means such as a mixing valve, shall be used at the hot water taps used by these people or at the water heater. Mixing valves are available at plumbing supply or hardware stores, see Figure 2. Follow manufacturer's instructions for installation of the valves. Before changing the factory setting on the thermostat, in this manual, see Figure 26.

Never allow small children to use a hot water tap, or to draw their own bath water. Never leave a child or handicapped person unattended in a bathtub or shower.

The water heater should be located in an area where the general public does not have access. If a suitable area is not available, a cover should be installed over the thermostat to prevent tampering.

The water temperature setting was factory set at the lowest temperature; Pressing the "COOLER" button decreases temperature and pressing the "HOTTER" button increases the temperature.

Setting the water heater temperature at 120°F (49°C) (Approx. "▼" mark on temperature setting of gas valve) will reduce the risks of scalds. Some states or local codes require settings at specific lower temperatures.

To avoid any unintentional changes in water temperature settings, the control has a tamper resistant feature for changing the temperature setting. To change the temperature setting follow these instructions:

1. "Wake Up" the temperature indicators by holding down both "COOLER" and "HOTTER" temperature adjustment buttons at the same time for one second, see Figure 26. One or two of the temperature indicators will light up. These indicators will only remain on for 30 seconds if no further buttons are pressed. After 30 seconds the control will go back to "Sleep" mode.

2. Release both of the temperature adjustment buttons.

- a. To decrease the temperature press and release the "COOLER" button until the desired setting is reached.
- b. To increase the temperature press and release the "HOTTER" button until the desired setting is reached.

NOTE: Holding down the button will not continue to lower or raise the temperature setting. The button must be pressed and released for each temperature change desired.

Should overheating occur or the gas supply fail to shut off, turn off the manual gas control valve to the appliance.

TEMPERATURE INDICATORS

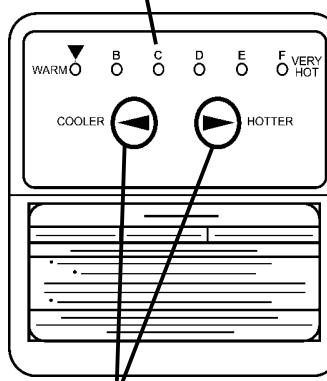

TEMPERATURE ADJUSTMENT BUTTONS

Temperature Setting	Display ▼ B C D E F	Time to Produce 2nd & 3rd Degree Burns on Adult Skin
F = approx. 180°F (82°C)	○○○○●	Nearly Instantaneous
E = approx. 170°F (77°C)	○○○○●○	Nearly Instantaneous
D = approx. 160°F (71°C)	○○○●○○	About 1/2 Second
C = approx. 150°F (65°C)	○○●○○○	About 1 1/2 Seconds
B = approx. 140°F (60°C)	○●○○○○	Less than 5 Seconds
▼ B = approx. 130°F (54°C)	●●○○○○	More than 30 Seconds
▼ = approx. 120°F (49°C)	●○○○○○	More than 5 Minutes

FIGURE 26.

FOR YOUR INFORMATION

START UP CONDITIONS

SMOKE/ODOR

It is not uncommon to experience a small amount of smoke and odor during the initial start-up. This is due to burning off of oil from metal parts, and will disappear in a short while.

THERMAL EXPANSION

CAUTION

Improper installation and use may result in property damage.

- Avoid water heater damage.
- Install thermal expansion tank or device if necessary.
- Contact qualified installer or service agency.

Water supply systems may, because of such events as high line pressure, frequent cut-offs, the effects of water hammer among others, have installed devices such as pressure reducing valves, check valves, back flow preventers, etc. to control these types of problems. When these devices are not equipped with an internal by-pass, and no other measures are taken, the devices cause the water system to be closed. As water is heated, it expands (thermal expansion) and closed systems do not allow for the expansion of heated water.

The water within the water tank expands as it is heated and increases the pressure of the water system. If the relieving point of the water heater's temperature-pressure relief valve is reached, the valve will release the excess pressure. **The temperature-pressure relief valve is not intended for the constant relief of thermal expansion.** This is an unacceptable condition and must be corrected. It is recommended that any devices installed which could create a closed system have a by-pass and/or the system have an expansion tank or device to relieve the pressure built by thermal expansion in the water system. Expansion tanks are available for ordering through a local plumbing contractor. Contact the local water heater supplier or service agency for assistance in controlling these situations.

STRANGE SOUNDS

Possible noises due to expansion and contraction of some metal parts during periods of heat-up and cool-down do not necessarily represent harmful or dangerous conditions.

Condensation causes sizzling and popping within the burner area during heating and cooling periods and should be considered normal. See "Condensate" in this section.

OPERATIONAL CONDITIONS

SMELLY WATER

In each water heater there is installed at least one anode rod (see parts section) for corrosion protection of the tank. Certain water

conditions will cause a reaction between this rod and the water. The most common complaint associated with the anode rod is one of a "rotten egg smell" in the hot water. The smell is a result of four factors which must all be present for the odor to develop:

- a. A concentration of sulfate in the supply water.
- b. Little or no dissolved oxygen in the water.
- c. A sulfate reducing bacteria which has accumulated within the water heater (this harmless bacteria is nontoxic to humans).
- d. An excess of active hydrogen in the tank. This is caused by the corrosion protective action of the anode.

Smelly water may be eliminated or reduced in some water heater models by replacing the anode(s) with one of less active material, and then chlorinating the water heater tank and all water lines. Contact the local water heater supplier or service agency for further information concerning an Anode Replacement Kit and this chlorination treatment.

If the smelly water persists after the anode replacement and chlorination treatment, we can only suggest that chlorination or aeration of the water supply be considered to eliminate the water problem.

Do not remove the anode leaving the tank unprotected. By doing so, all warranty on the water heater tank is voided.

"AIR" IN HOT WATER FAUCETS

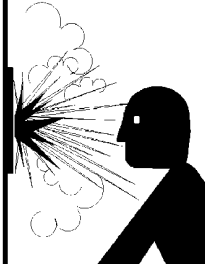

⚠ WARNING
Explosion Hazard
<ul style="list-style-type: none">• Flammable hydrogen gases may be present.• Keep all ignition sources away from faucet when turning on hot water.

HYDROGEN GAS: Hydrogen gas can be produced in a hot water system that has not been used for a long period of time (generally two weeks or more). Hydrogen gas is extremely flammable and explosive. To prevent the possibility of injury under these conditions, we recommend the hot water faucet, located farthest away, be opened for several minutes before any electrical appliances which are connected to the hot water system are used (such as a dishwasher or washing machine). If hydrogen gas is present, there will probably be an unusual sound similar to air escaping through the pipe as the hot water faucet is opened. There must be no smoking or open flame near the faucet at the time it is open.

HIGH WATER TEMPERATURE SHUT OFF SYSTEM

This water heater is equipped with an automatic reset type high limit (Energy Cutoff) sensor. The high limit switch interrupts the main burner gas flow should the water temperature reach 195°F (91°C). The high limit will automatically reset when the water temperature drops below 140°F (60°C). After cooling the tank temperature, turn off the water heater for at least 10 seconds by using the switch on top of the unit. Turn on the water heater. If this fails to correct the problem, contact your plumber or service representative.

PERIODIC MAINTENANCE

VENTING SYSTEM INSPECTION

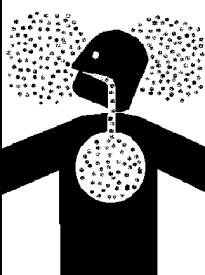
⚠ WARNING	
Breathing Hazard - Carbon Monoxide Gas	
	<ul style="list-style-type: none">• Flue gases may escape if vent pipe is not connected.• Be alert for obstructed, sooted or deteriorated vent system to avoid serious injury or death.• Do not store corrosive chemicals in vicinity of water heater.• Chemical corrosion of flue and vent system can cause serious injury or death.• Analyze the entire vent system to make sure that condensate will not become trapped in a section of vent pipe and therefore reduce the open cross sectional area of the vent.
Breathing carbon monoxide can cause brain damage or death. Always read and understand instruction manual.	

At least once a year a visual inspection should be made of the venting system. You should look for:

1. Obstructions which could cause improper venting. The combustion and ventilation air flow must not be obstructed.
2. Damage or deterioration which could cause improper venting or leakage of combustion products.

Be sure the vent piping is properly connected to prevent escape of dangerous flue gasses which could cause deadly asphyxiation.

Obstructions and deteriorated vent systems may present serious health risk or asphyxiation.

Chemical vapor corrosion of the flue and vent system may occur if air for combustion contains certain chemical vapors. Spray can propellants, cleaning solvents, refrigerator and air conditioner refrigerants, swimming pool chemicals, calcium and sodium chloride, waxes, bleach and process chemicals are typical compounds which are potentially corrosive.

If after inspection of the vent system you found sooting or deterioration, something is wrong. Call the local gas utility to correct the problem and clean or replace the flue and venting before resuming operation of the water heater.

BURNER OPERATION AND INSPECTION

Flood damage to a water heater may not be readily visible or immediately detectable. However, over a period of time a flooded water heater will create dangerous conditions which can cause **DEATH, SERIOUS BODILY INJURY, OR PROPERTY DAMAGE**. Contact a qualified installer or service agency to replace a flooded water heater. Do not attempt to repair the unit! It must be replaced!

At least once a year a visual inspection should be made of the main burner and the hot surface igniter assembly for proper flame

characteristics and ignition sequences. This can be done by removing the Outer Door and viewing the main burner operation through the Viewport on the Inner Door, see Figure 1. The main burner should provide complete combustion of gas, ignite rapidly, give reasonably quiet operation, and cause no excessive flame lifting from the burner ports. If the proper flame characteristics are not evident (see Figure 27), make sure that the flow of combustion and ventilation air is not blocked.

You should also check for sooting. Soot is not normal and will impair proper combustion. A visual inspection of the main burner and HSI igniter assembly should also be done at least once a year, see Figure 27.

Soot build-up indicates a problem that requires correction before further use. Turn "OFF" gas to water heater and leave off until repairs are made, because failure to correct the cause of the sooting can result in a fire causing death, serious injury, or property damage.

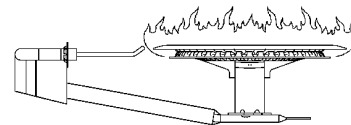



FIGURE 27.

BURNER CLEANING

In the event your burner or burner air openings require cleaning, turn the blower switch to the "OFF" position and allow the burner to cool. Call a service agency to remove and clean the burner and correct the problem that required the burner to be cleaned.

HOUSEKEEPING

Vacuum around base of water heater for dust, dirt, and lint on a regular basis.

⚠ DANGER	
Fire and Explosion Hazard	
	<ul style="list-style-type: none">• Do not obstruct combustion air openings at the bottom of the water heater.• Do not use or store flammable vapor products such as gasoline, solvents or adhesives in the same room or area near water heater or other appliance.• Can cause serious injury or death.

INSTALLED IN SUITABLE AREA: To insure sufficient ventilation and combustion air supply, proper clearances from the water heater must be maintained. See "Locating the New Water Heater" section. Combustible materials such as clothing, cleaning materials, or flammable liquids, etc. must not be placed against or adjacent to the water heater which can cause a fire.

ANODE ROD INSPECTION

CAUTION	
Property Damage Hazard	
<ul style="list-style-type: none">• Avoid water heater damage.• Inspection and replacement of anode rod required.	

The anode rod is used to protect the tank from corrosion. Most hot water tanks are equipped with an anode rod. The submerged rod sacrifices itself to protect the tank. Instead of corroding the tank, water ions attack and eat away the anode rod. This does not affect the water's taste or color. The rod must be maintained to keep the tank in operating condition.

Anode deterioration depends on water conductivity, not necessarily water condition. A corroded or pitted anode rod indicates high water conductivity and should be checked and/or replaced more often than an anode rod that appears to be intact. Replacement of a depleted anode rod can extend the life of your water heater. Inspection should be conducted by a qualified technician, and at a minimum should be checked annually after the warranty period.

TEMPERATURE-PRESSURE RELIEF VALVE OPERATION

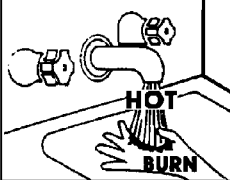
▲ DANGER	
	<ul style="list-style-type: none">• Burn hazard.• Hot water discharge.• Keep clear of relief valve discharge outlet.

The temperature-pressure relief valve must be manually operated at least once a year.

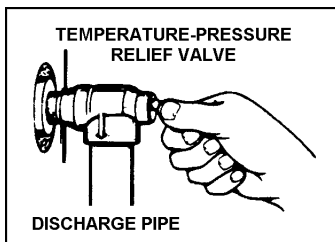

FIGURE 28.

When checking the temperature-pressure relief valve operation, make sure that (1) no one is in front of or around the outlet of the temperature-pressure relief valve discharge line, and (2) that the water discharge will not cause any property damage, as the water may be extremely hot, see Figure 28.

If after manually operating the valve, it fails to completely reset and continues to release water, immediately close the cold water inlet to the water heater, follow the draining instructions, and replace the temperature-pressure relief valve with a new one.

If the temperature-pressure relief valve on the appliance weeps or discharges periodically, this may be due to thermal expansion. You may have a check valve installed in the water line or a water meter with a check valve. Consult your local water supplier or service agency for further information. Do not plug the temperature-pressure relief valve.

DRAINING

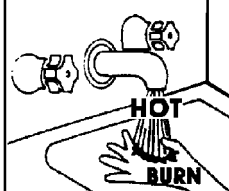
▲ DANGER	
	<ul style="list-style-type: none">• Burn hazard.• Hot water discharge.• Keep hands clear of drain valve discharge.

The water heater should be drained if being shut down during freezing temperatures. Also periodic draining and cleaning of sediment from the tank may be necessary.

1. Set the blower switch to the "OFF" position.
2. CLOSE the cold water inlet valve to the water heater.
3. OPEN a nearby hot water faucet and leave open to allow for draining.
4. Connect a hose to the drain valve and terminate to an adequate drain.
5. OPEN the water heater drain valve to allow for tank draining.

NOTE: If the water heater is going to be shut down and drained for an extended period, the drain valve should be left open with hose connected allowing water to terminate to an adequate drain.

6. CLOSE the drain valve.
7. Follow instructions in the "Filling The Water Heater" section.
8. Follow the lighting instructions on the label or see "Lighting Instructions" in this manual to restart the water heater.

SERVICE

If a condition persists or you are uncertain about the operation of the water heater contact a service agency.

Use this guide to check a "Leaking" water heater. Many suspected "Leakers" are not leaking tanks. Often the source of the water can be found and corrected.

If you are not thoroughly familiar with gas codes, your water heater, and safety practices, contact your gas supplier or qualified installer to check the water heater.

Read this manual first. Then before checking the water heater make sure the gas supply has been turned "OFF", and never turn the gas "ON" before the tank is completely full of water.

LEAKAGE CHECKPOINTS

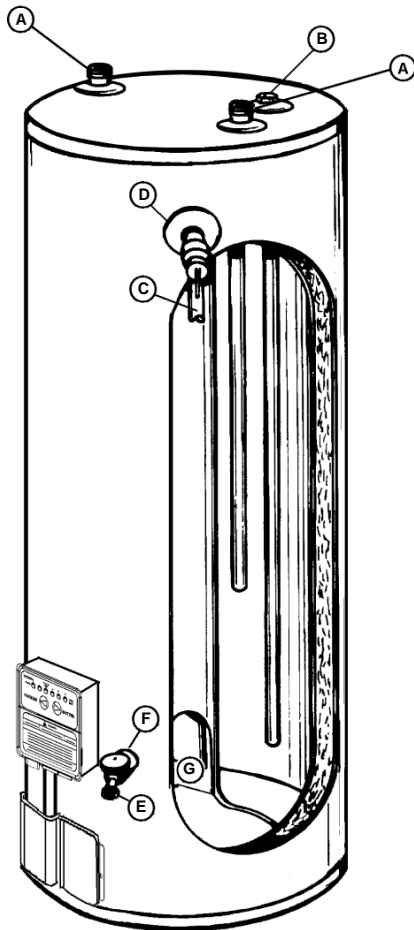

Never use this water heater unless it is completely filled with water. To prevent damage to the tank, the tank must be filled with water. Water must flow from the hot water faucet before turning "ON" gas to the water heater.

A *Condensation may be seen on pipes in humid weather or pipe connections may be leaking.

B. *The anode rod fitting may be leaking.

C. Small amounts of water from temperature-pressure relief valve may be due to thermal expansion or high water pressure in your area.

D. *The temperature-pressure relief valve may be leaking at the tank fitting.

E. Water from a drain valve may be due to the valve being slightly opened.

F. *The drain valve may be leaking at the tank fitting.

G. Combustion products contain water vapor which can condense on the cooler surfaces of the tank. Droplets form and drip onto the burner or run on the floor. This is common at the time of start-up after installation and when incoming water is cold.

H. Water in the water heater bottom or on the floor may be from condensation, loose connections, or the relief valve. DO NOT replace the water heater until a full inspection of all possible water sources is made and necessary corrective steps taken.

Leakage from other appliances, water lines, or ground seepage should also be checked.

* To check where threaded portion enters tank, insert cotton swab between jacket opening and fitting. If cotton is wet, follow "Draining" instructions in the "Periodic Maintenance" section and then remove fitting. Put pipe dope or teflon tape on the threads and replace. Then follow "Filling the Water Heater" instructions in the "Installing the New Water Heater" section.



⚠ WARNING

Read and understand instruction manual and safety messages before installing, operating or servicing this water heater.

Failure to follow instructions and safety messages could result in death or serious injury.

Instruction Manual must remain with water heater.

TROUBLESHOOTING GUIDELINES

TROUBLE SHOOTING

Please check guidelines below. For your safety, water heater service should be performed only by a qualified service technician. Read the GENERAL SAFETY INFORMATION section first.

INTELLI-VENT TROUBLESHOOTING CHART - RESIDENTIAL CONTROL

#	LED STATUS	PROBLEM	SOLUTION
1	▼ B C D E F ● ○ ○ ● ○ ○	Inadequate or no earth ground sensed by the Intelli-Vent™ control.	<ol style="list-style-type: none"> 1. Ensure the wall outlet is properly grounded. 2. Ensure all ground connections/wires on the water heater are secure.
2	▼ B C D E F ● ○ ● ○ ● ○	Power supply to Intelli-Vent™ control has reversed polarity or a high resistance to earth ground.	<ol style="list-style-type: none"> 1. Ensure the wall outlet is properly wired. 2. Ensure all internal 120 VAC wiring connections and wiring harness have no reversed wires. 120 VAC "hot" wire must connect to the on/off switch. 3. Ensure the wall outlet is properly grounded. 4. Ensure all ground connections/wires on the water heater are secure.
3	▼ B C D E F ● ○ ● ○ ○ ○	<p>Pressure switch circuit remaining closed for more than 5 seconds after heating cycle begins. Blower does not start.</p> <p>Service Note: Disconnect power - disconnect one wire from the air pressure switch or the vent temperature limit switch. Turn power back on - blower should start.</p>	<ol style="list-style-type: none"> 1. Ensure air pressure switch circuit wiring is correct and the air pressure switch is not jumpered. 2. Secure power to water heater, check continuity of air pressure switch contacts with wires disconnected. <ul style="list-style-type: none"> A If pressure switch contacts show continuity (closed circuit) replace the pressure switch. B If pressure switch contacts are open and all wiring is correct - turn the power off for 10-20 seconds then on again to clear the error code - if the error code persists replace the Intelli-Vent™ control.
4	▼ B C D E F ● ○ ● ○ ○ ●	<p>Pressure switch circuit remains open longer than 5 seconds after the blower is energized. Blower may run continuously in this condition.</p> <p>Service Note: To learn more about performing Air Pressure Switch tests visit our web site www.hotwater.com to download technical bulletin A-023-06 Air Pressure Switches.</p>	<ol style="list-style-type: none"> 1. Ensure the blower is running - check for 120 VAC to the blower when the heating cycle begins, check the wiring. If the control does not energize the blower - replace the Intelli-Vent™ control. If the blower fails to start when energized - replace the blower assembly. 2. Ensure the air pressure switch sensing tube is properly connected - not kinked or damaged. 3. Check continuity of vent temperature limit switch - replace switch if contacts remain open under 160°F (71°C). 4. Ensure the correct size of vent pipe (2", 3", 4") was used per installation manual for vent length. Ensure maximum number of elbows or equivalent feet of vent pipe has not exceeded maximum limits. 5. Ensure there are no obstructions in the vent pipe. 6. Check air pressure switch performance - check pressure with a digital manometer - check continuity of contacts. (see service note in left column) If the switch proves defective - replace the air pressure switch and or the blower assembly as required. 7. If air pressure switch performance test results prove the air pressure switch is working properly and error code 4 persists - replace the Intelli-Vent™ control.
5	▼ B C D E F ● ○ ● ○ ● ●	<p>The Intelli-Vent™ control has detected an open ignitor circuit.</p> <p>Service Note: The resistance (ohms) of a hot surface ignitor will increase over time. If the resistance at room temperature is near 18.8 ohms - consider replacing the ignitor as a preventative measure.</p>	<ol style="list-style-type: none"> 1. Check wiring to the hot surface ignitor - replace ignitor assembly if wiring is damaged or worn. 2. Check ignitor assembly plug and the socket on the Intelli-Vent™ body for good connection. Replace ignitor assembly and/or control if necessary. 3. Check resistance of ignitor at room temperature 77°F (25°C) at the plug end. Replace ignitor if resistance is not within 11.5 and 18.8 ohms at room temperature. 4. If results from the above tests were good and error code 5 persists - replace the Intelli-Vent™ control.

WATER HEATER CONTROL

TROUBLESHOOTING GUIDELINES

TROUBLE SHOOTING

Please check guidelines below. For your safety, water heater service should be performed only by a qualified service technician. Read the GENERAL SAFETY INFORMATION section first.

INTELLI-VENT TROUBLESHOOTING CHART - RESIDENTIAL CONTROL

#	LED STATUS	PROBLEM	SOLUTION
WATER HEATER CONTROL	6 ▼ B C D E F ● ○ ○ ● ● ○	Ignition/flame failure. The water heater has reached the maximum number of retries and is currently locked out for one hour. Cycle the power to the water heater off and on to reset. Service Note: The resistance (ohms) of a hot surface ignitor will increase over time. If the resistance at room temperature is near 18.8 ohms - consider replacing the ignitor as a preventative measure.	<ol style="list-style-type: none"> 1. Gas supply is turned off - pressure too low. Ensure supply and manifold gas pressures are within requirements in the installation manual. Manifold gas pressure is non-adjustable if pressure is off by more than 0.3" W.C. (75 Pa) replace the Intelli-Vent™ control. 2. Low supply voltage - should be 115 -125 VAC. 3. Ensure flame sensor is making good contact with the burner flame, ensure flame is steady see #8 below. 4. Ensure the flame sensor is clean - use ultra fine steel wool or Scotch-Brite™ pad to clean flame sensor. 5. Ensure the hot surface ignitor is positioned to provide consistent ignition. 6. Check for any cracks in ignitor assembly ceramic insulators - replace ignitor assembly if damaged. 7. Check resistance of ignitor at room temperature (77°F) (25°C) at the plug end. Replace ignitor if resistance is not within 11.5 and 18.8 ohms at room temperature. 8. Ensure the correct size of vent pipe (2", 3", 4") was used per installation manual for vent length. Using larger pipe than required may cause excessive air turbulence in the combustion chamber.
	7 ▼ B C D E F ● ○ ○ ○ ● ●	Self diagnostic tests have found a problem with the gas valve driver circuit, internal microprocessor, or other internal circuits.	<ol style="list-style-type: none"> 1. Turn the power off for 10-20 seconds then on again to clear these error codes. 2. If any of these error codes persist or cannot be cleared- replace the Intelli-Vent™ control.
	8 ▼ B C D E F ● ○ ● ● ● ○		
	9 ▼ B C D E F ● ● ● ● ● ●		
	10 ▼ B C D E F ● ○ ○ ● ● ●	Flame signal has been sensed out of proper sequence.	<ol style="list-style-type: none"> 1. Turn the power off for 10-20 seconds and then on again to clear this error code. 2. Replace the Intelli-Vent™ control if this error code persists.
11 ▼ B C D E F ● ○ ● ● ○ ○	Water temperature in the tank has exceeded 195°F (91°C) and has activated the ECO.	<ol style="list-style-type: none"> 1. Turn the power off for 10-20 seconds then on again to clear this error code. 2. Replace the Intelli-Vent™ if the error code persists. 	
12 ▼ B C D E F ● ○ ● ● ○ ○	The self diagnostic check detected one or both of the temperature adjust buttons are stuck.	<ol style="list-style-type: none"> 1. Press and release temperature adjust buttons. If the above action does not clear the error, the control will continue to regulate water temperature at the last setting. However, settings will no longer be adjustable - the control should be replaced. 	
13 ▼ B C D E F ● ○ ● ● ○ ●	The self diagnostic test has detected the water temperature sensor (thermistor) is either open or shorted.	<ol style="list-style-type: none"> 1. Turn the power off for 10-20 seconds then on again to clear this error code. 2. Replace the Intelli-Vent™ control if this error code persist. 	

TROUBLESHOOTING GUIDELINES

These guidelines should be utilized by a qualified service agent.

PROBLEM	CAUSE	SOLUTION
NOT ENOUGH HOT WATER	1.) Blower will not run.	
	a. "ON/OFF" control switch turned off.	Turn switch to the "ON" position.
	b. Blower unplugged.	Plug blower back into 115 VAC outlet.
	c. No power at outlet.	Repair service to outlet.
	d. Thermostat defective.	Replace thermostat.
	e. Control harness defective.	Replace control harness.
	f. High limit control circuit open.	Reduce the water temperature below 140°F. Turn the power switch to the off position. Wait 10 seconds. Turn the power switch to the on position. Reduce the temperature set point to minimize likelihood of reoccurrence. If this does not solve the problem, replace thermostat.
	g. Blower motor defective.	Replace blower assembly.
	2.) Thermostat problems	
	a. Thermostat set too low.	Adjust temperature control higher.
	b. Thermostat or ECO defective.	Replace thermostat.
	3.) Others	
	a. Heater undersized.	Reduce hot water use.
	b. Low gas pressure.	Contact dealer.
	c. Incoming water is usually cold.	Allow more time for heater to reheat.
d. Leaking hot water pipes or fixtures.	Have plumber check and repair leaks.	
e. Heater not lit or thermostat not on.	Refer to LIGHTING INSTRUCTIONS.	
VENT PIPE TOO HOT (ABOVE 170° F [77° C])	Wrong burner orifice.	Install correct orifice.
YELLOW FLAME	Dirt in burner ports.	Turn off heater and gas, clean burner head.
	Combustion air path restricted.	Check exhaust venting and air openings in bottom base pan for obstructions or blockage.
CONDENSATION	Water on the floor under heater.	See CONDENSATION section.
	Water dripping from blower assembly.	Provide drip "TEE" to catch condensation, see Figure 1.
WATER LEAKS	Improperly sealed, hot or cold supply connections, relief valve, drain valve or thermostat threads.	Check for leaks at all condensate points. See Figure 1. Also see LEAK CHECKPOINTS section.
	Leakage from other appliances or water lines.	Inspect other appliances near water heater.
	Condensation of flue products.	Refer to CONDENSATION section.
LEAKING T & P	Thermal expansion in closed water system.	Install thermal expansion tank (Do not plug T&P valve).
	Improperly sealed valve.	Check relief valve for proper operation (Do not plug T&P valve).
HOT WATER ODORS (refer to cathodic protection)	High sulfate or mineral content in water supply.	Drain and flush heater thoroughly then refill.
	Bacteria in water supply.	Chlorinate water supply.
WATER TOO HOT	Thermostat set too high.	Refer to TEMPERATURE REGULATION section.
WATER HEATER SOUNDS	Condensation dripping on burner.	Refer to CONDENSATION above.
SIZZLING - RUMBLING	Sediment at bottom of heater tank.	Clean sediment from tank. Refer to DRAINING.
SOOTING	Improper combustion.	Refer to Air Requirements.
BURNER WILL NOT STAY LIT – GOES OUT 4-5 SECONDS	Outlet polarity is reversed.	Test polarity and correct.
	High ambient room temperature.	Contact a service agency to determine cause.
	Combustion air path restricted.	Check exhaust venting and air openings in bottom base pan for obstructions or blockage.
	Defective gas valve.	Replace gas valve.
VENT GAS ODORS	Lack of air supply.	Shut off water heater immediately and contact a service agency to determine cause.
	Improperly installed vent piping.	
	Downdraft	
	Poor Combustion	

Limited Warranty

A. O. Smith Corporation, the warrantor, extends the following LIMITED WARRANTY to the owner of this water heater.

1. THE TANK

If the glass-lined tank in this water heater shall prove upon examination by the warrantor to have leaked due to natural corrosion from potable water therein, during the first THREE years after initial installation, the warrantor will supply a complete new A. O. Smith water heater of equivalent size and current model. Some government agencies are requiring energy efficient standards for water heaters. In the event regulations prohibit sale of a model of equivalent size and construction, A. O. Smith will provide a model which complies with the regulations of your area, in which case the consumer will be charged the difference in price between the like replacement and the energy efficient model required. The warranty on the replacement water heater will be limited to the unexpired term of the original warranty.

2. ALL OTHER PARTS

If within ONE year after initial installation of this water heater, any part or portion shall prove upon examination by the warrantor to be defective in material or workmanship, the warrantor will repair or replace such part or portion at its option.

3. CONDITIONS AND EXCEPTIONS

This warranty shall apply only when the water heater is installed in accordance with local plumbing and building codes, ordinances and regulations, the printed instructions provided with it and good industry practices. In addition, a temperature and pressure relief valve, certified by and officially sanctioned and recognized independent testing agency and approved by the American Society of Mechanical Engineers, must have been installed.

a. This warranty shall apply only when the heater is:

- (1) used at temperatures not exceeding the maximum calibrated setting of its thermostat;
- (2) used at water pressure not exceeding the working pressure shown on the heater;
- (3) filled with potable water, free to circulate at all times and with the tank free of damaging water sediment or scale deposits;
- (4) used in a non-corrosive and non-contaminated atmosphere;
- (5) used with factory approved anode(s) installed;
- (6) in its original installation location;
- (7) in the United States, its territories or possessions or Canada;
- (8) sized in accordance with proper sizing techniques for commercial and/or residential water heaters;
- (9) bearing a rating plate which has not been altered, defaced or removed, except as required by the warrantor;
- (10) used in an open system or in a closed system with properly sized and installed thermal expansion tank;
- (11) operated with properly installed dirt leg;
- (12) fired with the fuel for which it was factory built;
- (13) fired at the factory rated input;
- (14) operated with the inner and outer combustion chamber doors in place.

b. Any accident to the water heater, any misuse, abuse (including freezing or thermal expansion damage) or alteration of, any operation in a modified form, or any attempt to repair tank leaks will void this warranty.

c. This warranty is void if a device acting as a backflow prevention device (check valves etc.) is installed in the cold water supply the heater is connected to, unless an effective method of controlling thermal expansion is also installed at the heater(s) and operational at all times. The relief valve installed on the heater is not an acceptable method.

4. SERVICE AND REPAIR EXPENSES

Under the limited warranty the warrantor will provide only a replacement water heater or part thereof. The owner is responsible for all other costs. Such costs may include but are not limited to:

- a. Labor charges for service removal, repair or reinstallation of the water heater or any component part;
- b. Shipping, delivery, handling, and administrative charges for forwarding the new heater or replacement part from the nearest distributor and returning the claimed defective heater or part to such distributor.
- c. All cost necessary or incidental for any material and/or permits required for installation of the replacement heater or part.

5. LIMITATIONS ON IMPLIED WARRANTIES

Implied warranties, including the warranty of merchantability imposed on the sale of this heater under state law or local code are limited to one (1) year duration for the heater or any of its parts. Some areas do not allow limitation on how long an implied warranty lasts, so the above limitation may not apply to you.

6. CLAIM PROCEDURE

Any claim under the warranty should be initiated with the dealer who sold the heater, or with any other dealer handling the warrantor's products. If this is not practicable, the owner should contact:

U.S. Customers
A. O. Smith Water Products Company
500 Tennessee Waltz Parkway
Ashland City, TN 37015
Telephone: (800) 323-2636

- a. The warrantor will only honor replacement with identical or similar water heater or parts thereof which are manufactured or distributed by the warrantor.
- b. Dealer replacements are made subject to in-warranty validation by warrantor.

7. DISCLAIMERS

NO OTHER EXPRESS WARRANTY HAS BEEN OR WILL BE MADE IN BEHALF OF THE WARRANTOR WITH RESPECT TO THE MERCHANTABILITY OF THE HEATER OR THE INSTALLATION, OPERATION, REPAIR OR REPLACEMENT OF THE HEATER. THE WARRANTOR SHALL NOT BE RESPONSIBLE FOR WATER DAMAGE, LOSS OF USE OF THE UNIT, INCONVENIENCE, LOSS OR DAMAGE TO PERSONAL PROPERTY OR OTHER CONSEQUENTIAL DAMAGE. THE WARRANTOR SHALL NOT BE LIABLE BY VIRTUE OF THIS WARRANTY OR OTHERWISE FOR DAMAGE TO ANY PERSONS OR PROPERTY, WHETHER DIRECT OR INDIRECT, AND WHETHER ARISING IN CONTRACT OR IN TORT.

- a. Some areas do not allow the exclusion or limitation of the incidental or consequential damage, so the above limitations or exclusions may not apply to you.
- b. This warranty gives you specific legal rights, and you may also have other rights which vary from area to area.

Fill in the following for your own reference. Keep it. Registration is not a condition of warranty. The model and serial number are found on the heater's rating plate.

Model No. _____ Serial No. _____ Date Installed _____

Dealer's Name _____

Dealer's Address _____ Phone No. _____

City and State _____ Zip _____

Free Manuals Download Website

<http://myh66.com>

<http://usermanuals.us>

<http://www.somanuals.com>

<http://www.4manuals.cc>

<http://www.manual-lib.com>

<http://www.404manual.com>

<http://www.luxmanual.com>

<http://aubethermostatmanual.com>

Golf course search by state

<http://golfingnear.com>

Email search by domain

<http://emailbydomain.com>

Auto manuals search

<http://auto.somanuals.com>

TV manuals search

<http://tv.somanuals.com>