

Service
Service
Service



Service Manual

Horizontal Frequency
30-83KHz

Table of Contents

Description	Page	Description	Page
Table of Contents.....	1	5.Block Diagram.....	25
Revision List.....	2	6.Schematic.....	26
Important Safety Notice.....	3	6.1.Main Board.....	25
1.Monitor Specification.....	4	6.2.Key Board.....	31
2.LCD Monitor Description.....	5	7.PCB Layout.....	32
3.Operation Instruction.....	6	7.1.Main Board.....	32
3.1.General Instructions.....	6	7.2.Key Board.....	34
3.2.Hot Keys.....	6	8.Maintainability.....	35
3.3.OSD Setting.....	7	8.1.Equipments and Tools Requirement.....	35
4.Input/Output Specification.....	20	8.2.Trouble Shooting.....	36
4.1.Input Signal Connector.....	20	9.White-Balance, Luminance Adjustment.....	40
4.2.Factory Preset Display Modes.....	21	10.Monitor Exploded View.....	42
4.3.Panel Specification.....	22	11.BOM List.....	44

SAFETY NOTICE

ANY PERSON ATTEMPTING TO SERVICE THIS CHASSIS MUST FAMILIARIZE HIMSELF WITH THE CHASSIS AND BE AWARE OF THE NECESSARY SAFETY PRECAUTIONS TO BE USED WHEN SERVICING ELECTRONIC EQUIPMENT CONTAINING HIGH VOLTAGES.

CAUTION: USE A SEPARATE ISOLATION TRANSFORMER FOR THIS UNIT WHEN SERVICING

Important Safety Notice

Proper service and repair is important to the safe, reliable operation of all AOC Company Equipment. The service procedures recommended by AOC and described in this service manual are effective methods of performing service operations. Some of these service operations require the use of tools specially designed for the purpose. The special tools should be used when and as recommended.

It is important to note that this manual contains various CAUTIONS and NOTICES which should be carefully read in order to minimize the risk of personal injury to service personnel. The possibility exists that improper service methods may damage the equipment. It is also important to understand that these CAUTIONS and NOTICES ARE NOT EXHAUSTIVE. AOC could not possibly know, evaluate and advise the service trade of all conceivable ways in which service might be done or of the possible hazardous consequences of each way. Consequently, AOC has not undertaken any such broad evaluation. Accordingly, a servicer who uses a service procedure or tool which is not recommended by AOC must first satisfy himself thoroughly that neither his safety nor the safe operation of the equipment will be jeopardized by the service method selected.

Hereafter throughout this manual, AOC Company will be referred to as AOC.

WARNING

Use of substitute replacement parts, which do not have the same, specified safety characteristics may create shock, fire, or other hazards.

Under no circumstances should the original design be modified or altered without written permission from AOC. AOC assumes no liability, express or implied, arising out of any unauthorized modification of design. Servicer assumes all liability.

FOR PRODUCTS CONTAINING LASER:

DANGER-Invisible laser radiation when open AVOID DIRECT EXPOSURE TO BEAM.

CAUTION-Use of controls or adjustments or performance of procedures other than those specified herein may result in hazardous radiation exposure.

CAUTION -The use of optical instruments with this product will increase eye hazard.

TO ENSURE THE CONTINUED RELIABILITY OF THIS PRODUCT, USE ONLY ORIGINAL MANUFACTURER'S REPLACEMENT PARTS, WHICH ARE LISTED WITH THEIR PART NUMBERS IN THE PARTS LIST SECTION OF THIS SERVICE MANUAL.

Take care during handling the LCD module with backlight unit

- Must mount the module using mounting holes arranged in four corners.
- Do not press on the panel, edge of the frame strongly or electric shock as this will result in damage to the screen.
- Do not scratch or press on the panel with any sharp objects, such as pencil or pen as this may result in damage to the panel.
- Protect the module from the ESD as it may damage the electronic circuit (C-MOS).
- Make certain that treatment person's body is grounded through wristband.
- Do not leave the module in high temperature and in areas of high humidity for a long time.
- Avoid contact with water as it may a short circuit within the module.
- If the surface of panel becomes dirty, please wipe it off with a soft material. (Cleaning with a dirty or rough cloth may damage the panel.)

1. Monitor Specifications

Panel	Model name	E2251S _{WDN}
	Driving system	TFT Color LCD
	Viewable Image Size	546.86 mm diagonal
	Pixel pitch	0.0827*RGB(H)mm x 0.248(V)mm
	Video	R, G, B Analog Interface
	Separate Sync.	H/V TTL
	Display Color	16.7M Colors
	Dot Clock	170 MHz
Resolution	Horizontal scan range	30kHz - 83kHz
	Horizontal scan Size(Maximum)	498.1 mm
	Vertical scan range	50Hz - 76Hz
	Vertical scan Size(Maximum)	291.4mm
	Optimal preset resolution	1920×1080@60Hz
	Plug & Play	VESA DDC2B
	Input Connector	VGA/DVI
	Input Video Signal	Analog: 0.7Vp-p(standard), 75 OHM, Positive
	Power Source	100-240V ~, 50/60Hz
	Power Consumption	Typical: 26W (Max:32W)
		Standby < 0.5 W
Off timer	0-24 hrs	
Physical Characteristics	Connector Type	VGA/DVI
	Signal Cable Type	Detachable
	Dimensions & Weight:	
	Height (with base)	389.1 mm
	Width	512.5 mm
	Depth	193.7 mm
	Weight (monitor only)	2.168 kg
	Weight (with packaging)	3.360 kg
Environmental	Temperature:	
	Operating	0° to 40°
	Non-Operating	-25°to 55°
	Humidity:	
	Operating	10% to 85% (non-condensing)
	Non-Operating	5% to 93% (non-condensing)
	Altitude:	
	Operating	0~ 2000m (0~ 6512 ft)
	Non-Operating	0~ 12192m (0~ 40000 ft)

2. LCD Monitor Description

The LCD MONITOR will contain a main board and a key board which house the flat panel control logic, brightness control logic and DDC.

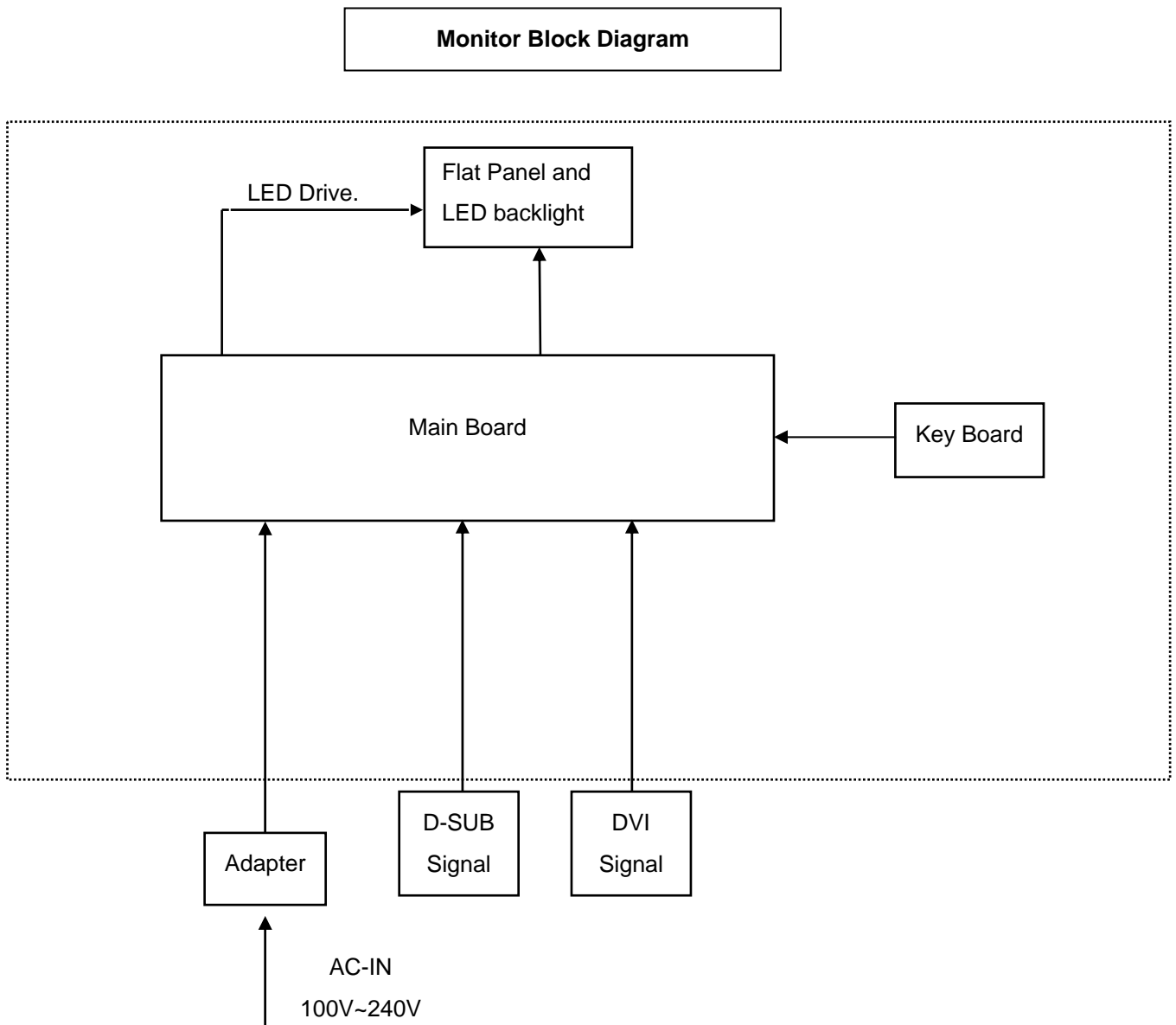

3. Operating Instructions

3.1 General Instructions

Press the power button to turn the monitor on or off. The other control knobs are located at front panel of the monitor. By changing these settings, the picture can be adjusted to your personal preferences.

3.2 Hotkeys

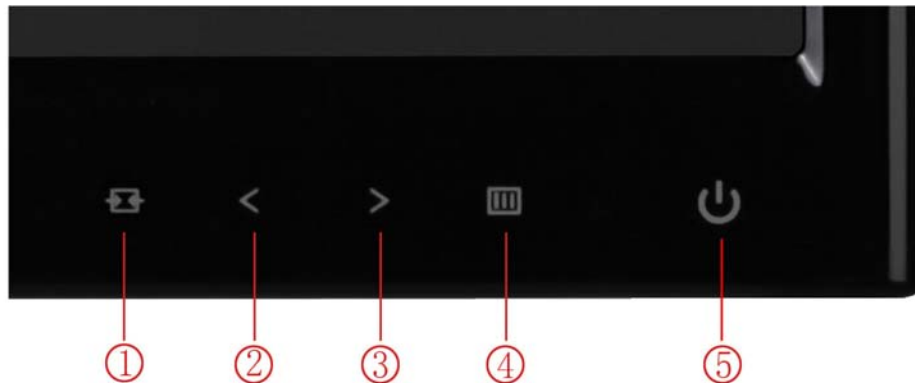

1	Source/Auto/Exit
2	ECO/-
3	4:3/Wide/+
4	Menu/Enter
5	Power



Power

Press the Power button to turn on/off the monitor.



Menu/Enter

Press to display the OSD or confirm the selection

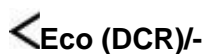

Press the Eco key continuously to select the Eco mode of brightness and DCR on when there is no OSD. (Eco mode hot key may not be available in all models).



When there is no OSD, press > continuously to change 4:3 or wide image ratio. (If the product screen size is 4:3 or input signal resolution is wide format, the hot key is disabled to adjust.)



Source/Auto / Exit

Auto / Exit









When the OSD is closed, press Auto/Source/Exit button continuously about 2 second to do auto configure (only for the models with dual or more inputs).

When the OSD is closed, press Auto/Source/Exit button will be Source hot key function (Only for the models with dual or more inputs).

3.3 OSD Setting

Basic and simple instruction on the control keys.



- 1) Press the  **MENU-button** to activate the OSD window.
- 2) Press **< or >** to navigate through the functions. Once the desired function is highlighted, press the  **MENU-button** to activate sub-menu. Once the desired function is highlighted, press  **MENU-button** to activate it.
- 3) Press **< or >** to change the settings of the selected function. Press  **AUTO** to exit. If you want to adjust any other function, repeat steps 2-3.
- 4) OSD Lock Function: To lock the OSD, press and hold the  **MENU button** while the monitor is off and then press  **power button** to turn the monitor on. To un-lock the OSD - press and hold the  **MENU button** while the monitor is off and then press  **power button** to turn the monitor on.

Notes:

- 1) If the product has only one signal input, the item of "Input Select" is disable to adjust.
- 2) If the product screen size is 4:3 or input signal resolution is wide format, the item of "Image Ratio" is disable to adjust.
- 3) One of DCR, Color Boost, and Picture Boost functions is active, the other two function is turned off accordingly.

Luminance

1



Press  (Menu) to display menu



2



Press  or  to select  (Luminance), and press  to enter

3

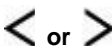

Press  or  to select submenu, and press to  enter.

4



Press < or > to adjust

5



Press  to exit.









	Brightness	0-100		Backlight Adjustment
	Contrast	0-100		Contrast from Digital-register.
	Eco mode	Standard	<input checked="" type="checkbox"/>	Standard Mode
		Text		Text Mode
		Internet		Internet Mode
		Game		Game Mode
		Movie		Movie Mode
		Sports		Sports Mode
	Gamma	Gamma1	Adjust to Gamma1	
		Gamma2	Adjust to Gamma 2	
		Gamma3	Adjust to Gamma 3	
	DCR	Off		Disable dynamic contrast ratio
		On		Enable dynamic contrast ratio

Image Setup

1



Press  (Menu) to display menu



2



Press  or  to select  (Image Setup) , and press  to enter.



3



Press  or  to select submenu, and press  to enter.

4



Press  or  to adjust.

5



Press  to exit.

	Clock	0-100	Adjust picture Clock to reduce Vertical-Line noise.
	Phase	0-100	Adjust Picture Phase to reduce Horizontal-Line noise
	Sharpness	0-100	Adjust picture sharpness
	H.Position	0-100	Adjust the horizontal position of the picture.
	V.Position	0-100	Adjust the vertical position of the picture.

Color Setup

1



Press  (Menu) to display menu.

2



Press  or  to select  (Color Setup), and press  to enter.

3



Press < or > to select submenu, and press  to enter.

4



Press < or > to adjust.

5



Press  to exit.

	Color setup.	Warm		Recall Warm Color Temperature from EEPROM.	
		Normal		Recall Normal Color Temperature from EEPROM.	
		Cool		Recall Cool Color Temperature from EEPROM.	
		sRGB		Recall sRGB Color Temperature from EEPROM.	
		User	Red		Red Gain from Digital-register
			Green		Green Gain Digital-register.
	Blue			Blue Gain from Digital-register	
	DCB Mode	Full Enhance	on or off	Disable or Enable Full Enhance Mode	
		Nature Skin	on or off	Disable or Enable Nature Skin Mode	
		Green Field	on or off	Disable or Enable Green Field Mode	
		Sky-blue	on or off	Disable or Enable Sky-blue Mode	
		AutoDetect	on or off	Disable or Enable AutoDetect Mode	
	DCB Demo		on or off	Disable or Enable Demo	

Picture Boost

1



Press  (Menu) to display menu.

2



Press < or > to select  (Picture Boost), and press  to enter.

3



Press < or > to select submenu, and press  to enter.

4



Press < or > to adjust.

5



Press  to exit.

	Frame Size	14-100	Adjust Frame Size
	Brightness	0-100	Adjust Frame Brightness
	Contras	0-100	Adjust Frame Contrast
	H. position	0-100	Adjust Frame horizontal Position
	V.position	0-100	Adjust Frame vertical Position
	Bright Frame	on or off	Disable or Enable Bright Frame

OSD Setup

1



Press  (Menu) to display menu.



2



Press  or  to select  (OSD Setup), and press  to enter.

3



Press  or  to select submenu, and press to enter.

4



Press < or > to adjust.

5



Press  to exit.

	H.Position	0-100	Adjust the horizontal position of OSD
	V.Position	0-100	Adjust the vertical position of OSD
	Timeout	5-120	Adjust the OSD Timeout
	Transparence	0-100	Adjust the transparence of OSD
	Language		Select the OSD language

Extra

1



Press  (Menu) to display menu.

2



Press < or > to select  (Extra), and press  to enter.

3



Press < or > to select submenu, and press  to enter.

4



Press < or > to adjust.

5



Press  to exit.

	Input Select	Auto	Select to Auto Detect input signal
		Analog	Select Analog Signal Source as Input
		DVI	Select DVI Signal Source as Input
	Auto Config	yes or no	Auto adjust the picture to default
	Off timer	0-24hrs	Select DC off time
	Image Ratio	wide or 4:3	Select wide or 4:3 format for display
	DDC-CI	yes or no	Turn ON/OFF DDC-CI Support
	Reset	Yes or no	Reset the menu to default
	Information		Show the information of the main image and sub-image source

Exit

1



Press  (Menu) to display menu.

2



Press  or  to select  (Exit), and press  to exit.

	Exit		Exit the main OSD
---	------	--	-------------------

LED Indicator

Status	LED Color
Full Power Mode	Blue
Active-off Mode	Orange

4. Input/Output Specification

4.1 D-SUB CONNECTORS

Pin Assignments

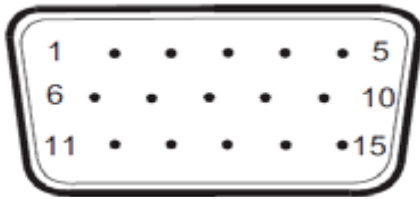

Pin Number	15-Pin Side of the Signal Cable	Pin Number	15-Pin Side of the Signal Cable
1	Video-Red	9	+5V
2	Video-Green	10	Ground
3	Video-Blue	11	N.C.
4	N.C.	12	DDC- Serial data
5	Detect Cable	13	H- sync
6	GND-R	14	V- sync
7	GND-G	15	DDC- Serial clock
8	GND-B		

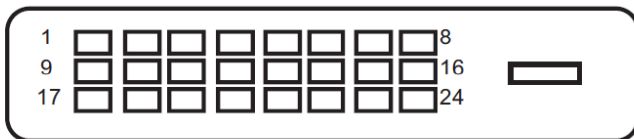

Pin Number	24-Pin Color Display Signal Cable	Pin Number	24-Pin Color Display Signal Cable
1	TMDS data 2-	13	TMDS data 3+
2	TMDS data 2+	14	+5V Power
3	TMDS data 2/4 Shield	15	Ground (for+5V)
4	TMDS data 4-	16	Hot Plug Detect
5	TMDS data 4+	17	TMDS data 0-
6	DDC Clock	18	TMDS data 0+
7	DDC Data	19	TMDS data 0/5 Shield
8	N.C.	20	TMDS data 5-
9	TMDS data 1-	21	TMDS data 5+
10	TMDS data 1+	22	TMDS Clock Shield
11	TMDS data 1/3 Shield	23	TMDS Clock +
12	TMDS data 3-	24	TMDS Clock -

4.2 Factory Preset Display Modes

STAND	RESOLUTION	HORIZONTAL FREQUENCY(kHZ)	VERTICAL FREQUENCY(Hz)
VGA	640x480@60Hz	31.469	59.940
	640x480@72Hz	37.861	72.809
	640x480@75Hz	37.500	75.00
SVGA	800x600@56Hz	35.156	56.250
	800x600@60Hz	37.879	60.317
	800x600@72Hz	48.077	72.188
	800x600@75Hz	46.875	75.000
XGA	1024x768@60Hz	48.363	60.004
	1024x768@70Hz	56.476	70.069
	1024x768@75Hz	60.023	75.029
***	1280x720@60Hz	45.000	60.000
SXGA	1280x1024@60Hz	63.981	60.020
	1280x1024@75Hz	79.976	75.025
WXGA+	1440x900@60Hz	55.935	59.887
	1440x900@60Hz	55.469	59.901
WSXGA	1680x1050@60Hz	65.290	59.954
	1680x1050@60Hz	64.674	59.883
HD	1920x1080@60Hz	67.500	60.000
	1280x960@60HZ	60.000	60.000
IBM MODES			
DOS	720x400@70Hz	31.469	70.087
MAC MODES			
VGA	640x480@67Hz	35.000	66.667
SVGA	832x624@75Hz	49.725	74.551
XGA	1024x768@75Hz	60.241	74.927

4.3 Panel Specification

4.3.1 General Features

BM215WF4-T2BB is a Color Active Matrix Liquid Crystal Display with an integral Light Emitting Diode (LED) backlight system. The matrix employs a-Si Thin Film Transistor as the active element. It is a transmissive type display operating in the normally white mode. It has a 21.5 inch diagonally measured active display area with Full HD resolution (1080 vertical by 1920 horizontal pixel array) Each pixel is divided into Red, Green and Blue sub-pixels or dots which are arranged in vertical stripes. Gray scale or the brightness of the sub-pixel color is determined with a 8-bit gray scale signal for each dot, thus, presenting a palette of more than 16,7M colors with Advanced-FRC(Frame Rate Control). It has been designed to apply the interface method that enables low power, high speed, low EMI. FPD Link or compatible must be used as a LVDS(Low Voltage Differential Signaling) chip. It is intended to support applications where thin thickness, wide viewing angle, low power are critical factors and graphic displays are important. In combination with the vertical arrangement of the sub-pixels, the BM215WF4-T2BB characteristics provide an excellent flat panel display for office automation products such as monitors.

4.3.2 Display Characteristics

Active screen size	21.53 inches(546.86mm) diagonal
Outline Dimension	498.9 (H) x 292.2 (V) x 8.4 (D) mm(Typ.)
Pixel Pitch	0.0827*RGB(H)mm x 0.248(V)mm
Pixel Format	1920 horiz. By 1080 vert. Pixels RGB stripes arrangement
Interface	LVDS 2Port
Color depth	16.7M colors
Luminance, white	200 cd/m ² (Center 1Point, typ)
Viewing Angle (CR>10)	R/L 90(Typ.), U/D 50(Typ.)
Power Consumption	Total 16.3 W(Typ.), (5.0 W@V _{LCD} , 11.3 W@W/O Driver)
Weight	1240 g (Typ.)
Display operating mode	Transmissive mode, Normally White
Surface treatments	Hard coating (3H), Anti-glare treatment of the front polarizer
Color Gamut	72%(Typ.) CIE 1931

4.3.3 Electrical Characteristics

Ta = 25°C

Parameter	Symbol	Values			Unit	Notes
		Min	Typ	Max		
MODULE :						
Power Supply Input Voltage	V_{LCD}	4.5	5.0	5.5	Vdc	
Permissive Power Input Ripple	V_{LCD}	-	-	0.3	V	3
Power Supply Input Current	$I_{LCD-MOSAIC}(60Hz)$	-	1000	1300	mA	1,5
	$I_{LCD-BLACK}(60Hz)$	-	1300	1690	mA	2,5
	$I_{LCD-BLACK}(75Hz)$		-	2000	mA	5
Power Consumption	P_{LCD}	-	5.00	6.5	Watt	1
Inrush current	I_{RUSH}	-	-	3.0	A	1, 4

LED bar Electrical characteristics

Parameter	Symbol	Condition	Values			Unit	Notes
			Min.	Typ.	Max.		
LED :							1,7
LED String Current	I_s		-	110	120	mA	2,7
LED String Voltage	V_s		48.0	51.2	54.4	V	3,7
Power Consumption	P_{Bar}		-	11.3	12.0	Watt	4,6,7
LED Life Time	LED_LT		30,000	-	-	Hrs	5,7

4.3.4 Optical Characteristics

(Ta=25 °C, V_{LCD}=5.0V, f_V=60Hz, D_{CLK}=72MHz, I_s=110mA)

Parameter	Symbol		Values			Units	Notes
			Min	Typ	Max		
Contrast Ratio	CR		400	600	-		1 (PR-880)
Surface Luminance, white	L _{WH}		160	200	-	cd/m ²	2 (PR-880)
Luminance Variation	δ _{WHITE}	9P	75	-	-	%	3 (PR-880)
Response Time	Rise Time	Tr _R	-	1.3	2.6	ms	4 (RD80S)
	Decay Time	Tr _D	-	3.7	7.4	ms	
Color Coordinates [CIE1931]	RED	Rx	Typ -0.03	0.642	Typ +0.03		(PR-650)
		Ry		0.332			
	GREEN	Gx		0.305			
		Gy		0.625			
	BLUE	Bx		0.150			
		By		0.068			
	WHITE	Wx		0.313			
		Wy		0.329			
Viewing Angle (CR>5)							5 (PR-880)
	x axis, right(φ=0°)	θ _r	45	50		Degree	
	x axis, left (φ=180°)	θ _l	45	50			
	y axis, up (φ=90°)	θ _u	20	25			
	y axis, down (φ=270°)	θ _d	40	45			
Viewing Angle (CR>10)							
	x axis, right(φ=0°)	θ _r	40	45		Degree	
	x axis, left (φ=180°)	θ _l	40	45			
	y axis, up (φ=90°)	θ _u	10	15			
	y axis, down (φ=270°)	θ _d	30	35			
Crosstalk					1.5	%	6 (PR880)

5. Block Diagram

5.1 Main Board

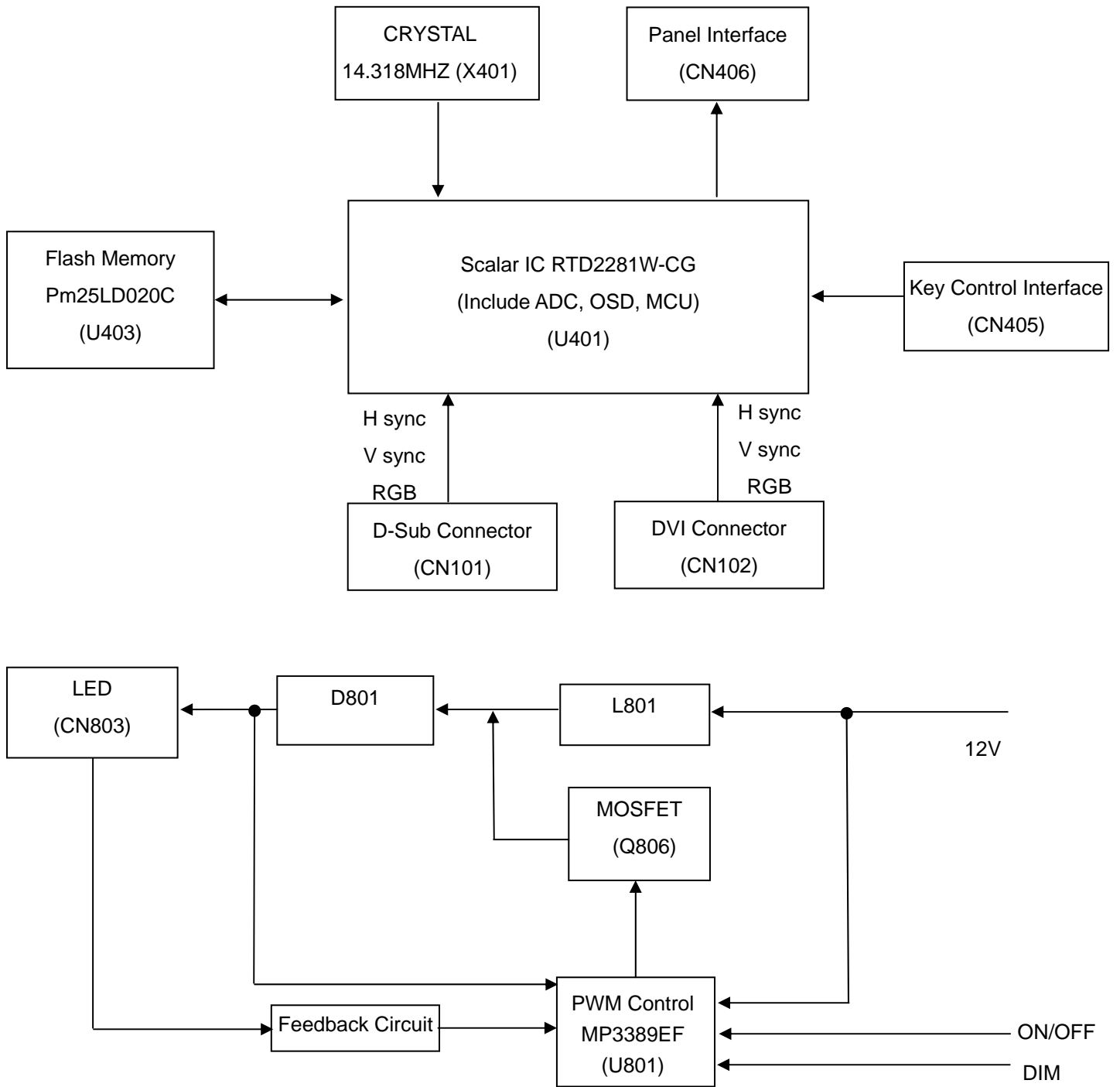

6. Schematic

6.1 Main Board

715G4798M0E000004L

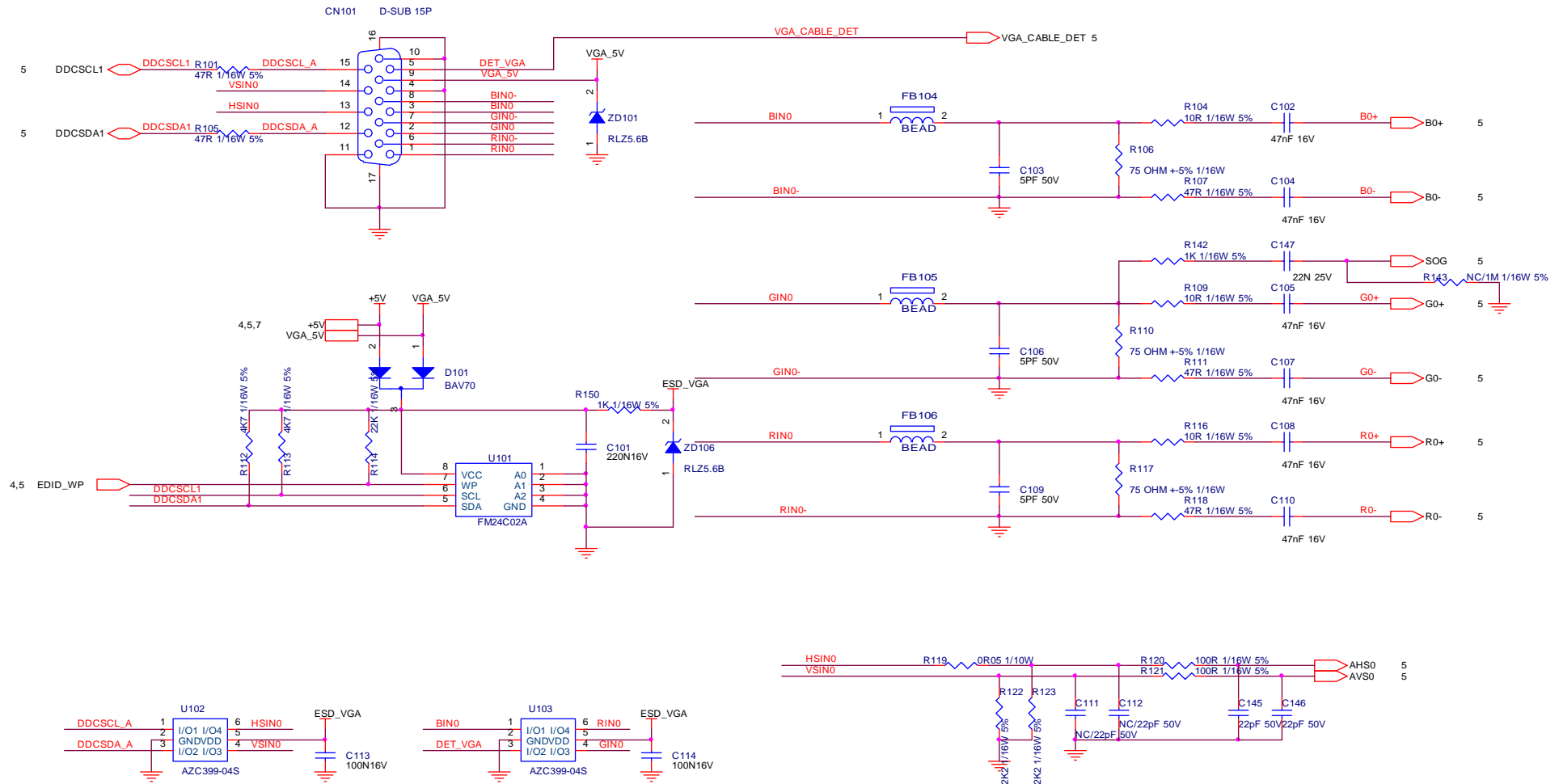

TPV (Top Victory Electronics Co., Ltd.)	OEM MODEL	AOC 50ID	Size	B
話隔瓜網膜	715G4798-M0A-000-0040_101101	TPV MODEL	AOC 50ID	Rev
Key Component	D-SUB I/O	PCB NAME	715G4798-M0A	修差
Date	Thursday, May 12, 2011	Sheet	3 of 8	<修差>

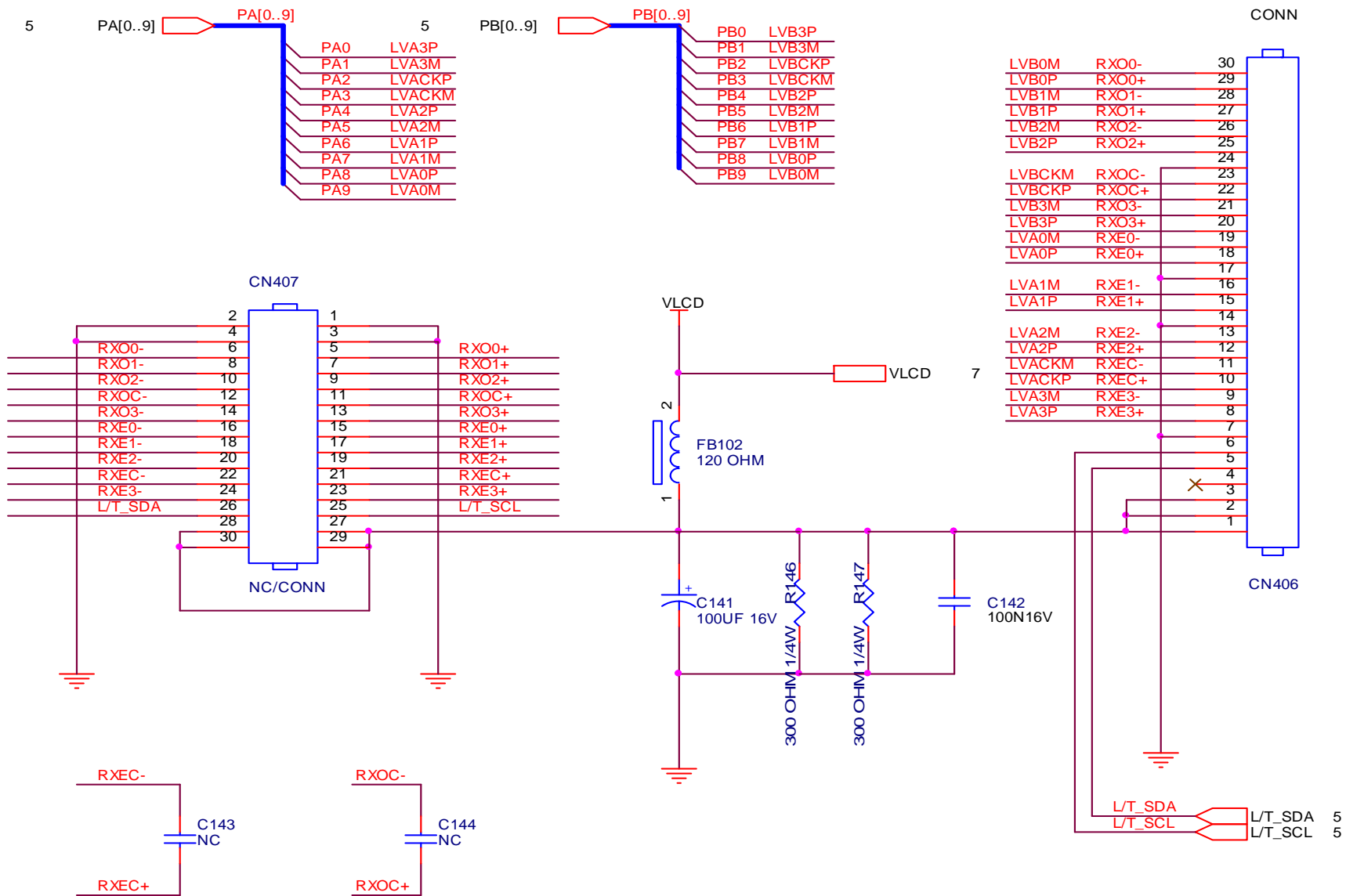

TPV (Top Victory Electronics Co., Ltd.)	OEM MODEL	AOC 50ID	Size	A
結隔瓜網腹	715G4798-M0A-000-0040_101101	TPV MODEL	Rev	A
Key Component	LVDS PANEL I/O	PCB NAME	715G4798-M0A	稱爹
Date	Thursday, May 12, 2011	Sheet	6 of 8	<稱爹>

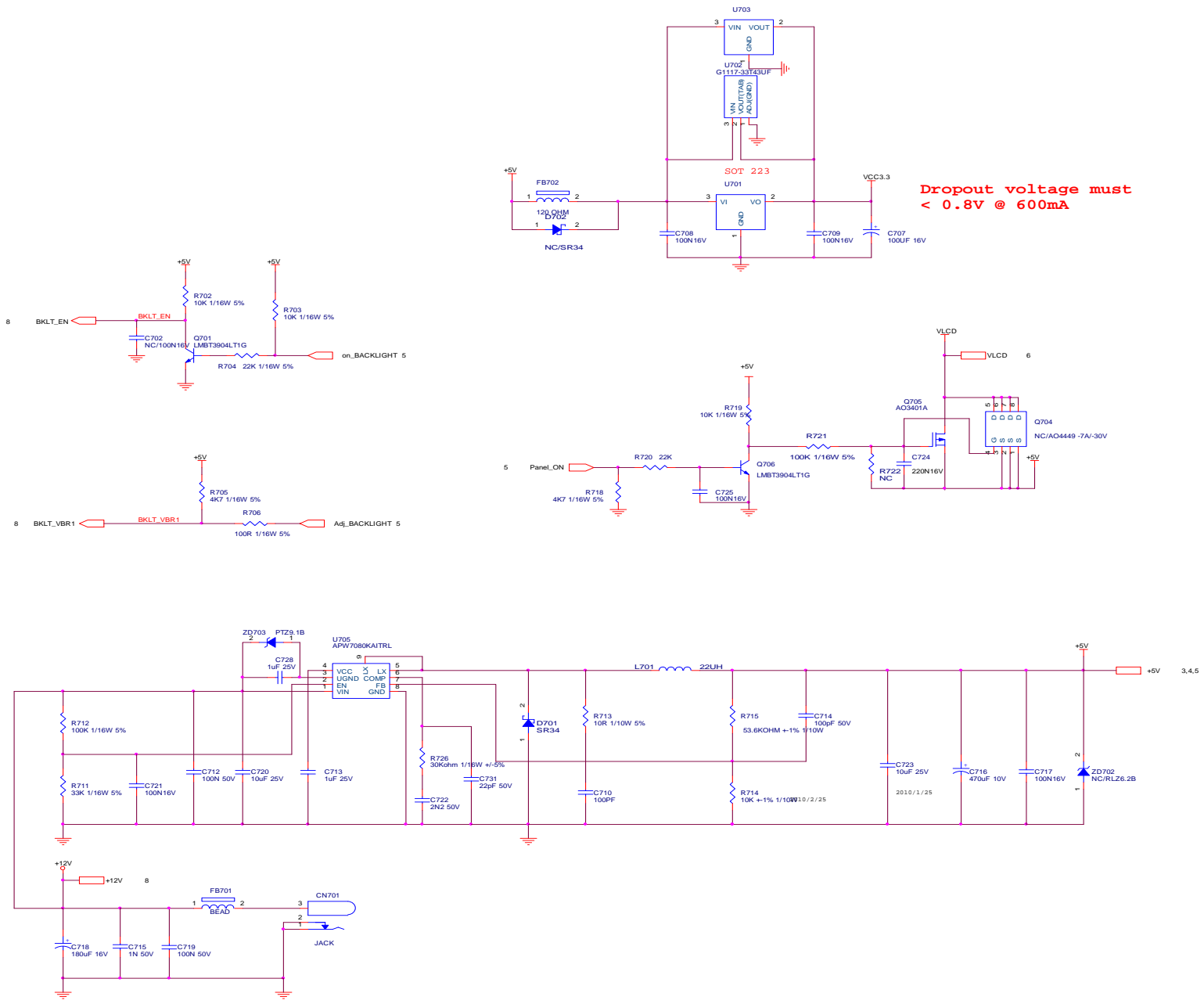

Dropout voltage must < 0.8V @ 600mA



TPV (Top Victory Electronics Co., Ltd.)	OEM MODEL	AOC 50ID	Size	C
新 冠 瓜 瓜 瓜	715G4798-MMA-000-0040_101101	TPV MODEL	Rev	D
Key Component	POWER	PCB NAME		名称 <名称>
Date	Friday, May 13, 2011	Sheet	7 of 8	

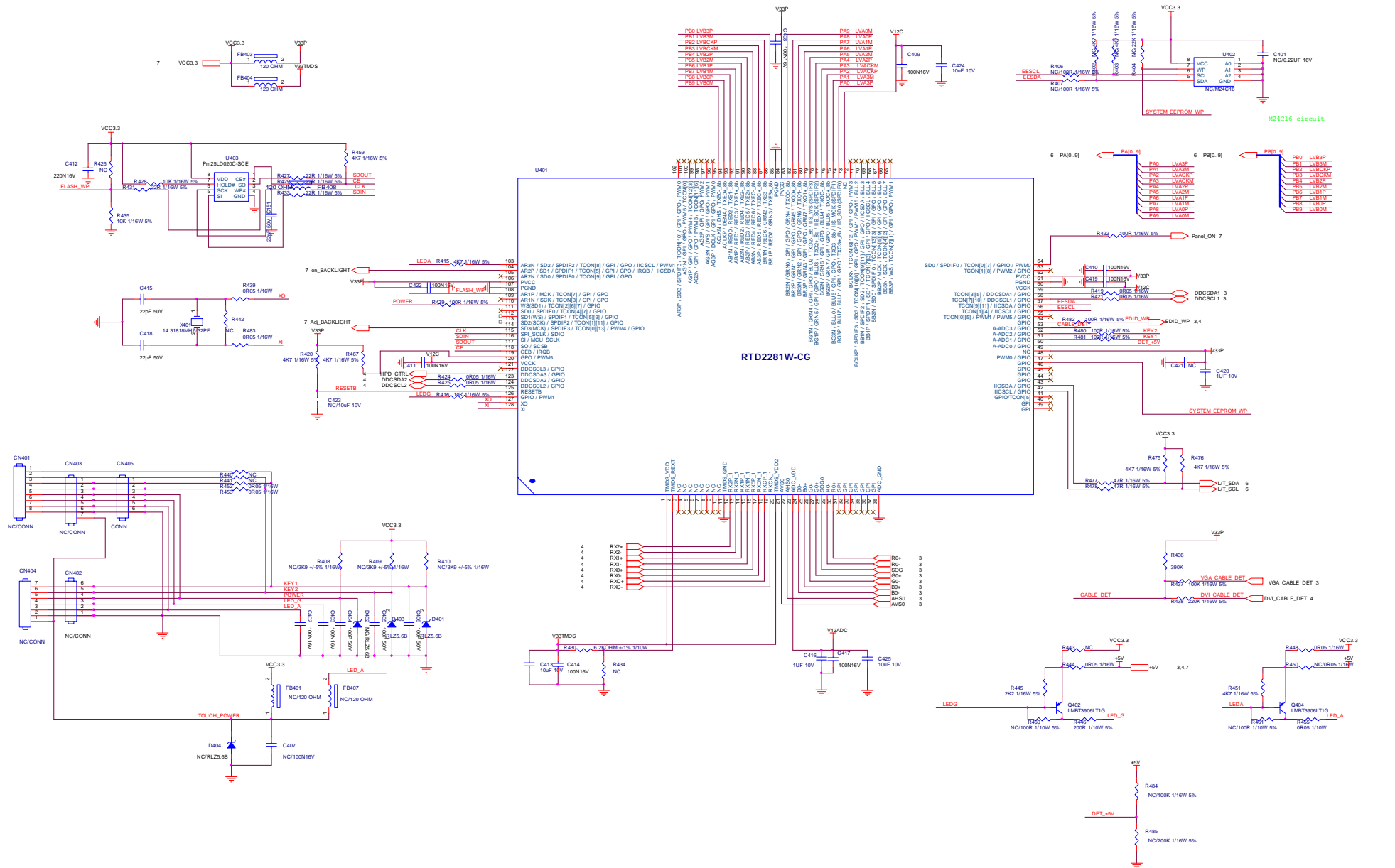

TPV (Top Victory Electronics Co., Ltd.)	OEM MODEL	ADC 50D	Size	Custom
拓普仕电子	T15G4798-MDA-000-0040_101101	ADC 50D	Rev	A
Key Component	SCALER	PCB NAME	T15G4798-MDA	Page
Date	Thursday, May 12, 2011	Sheet	5 of 8	<8>

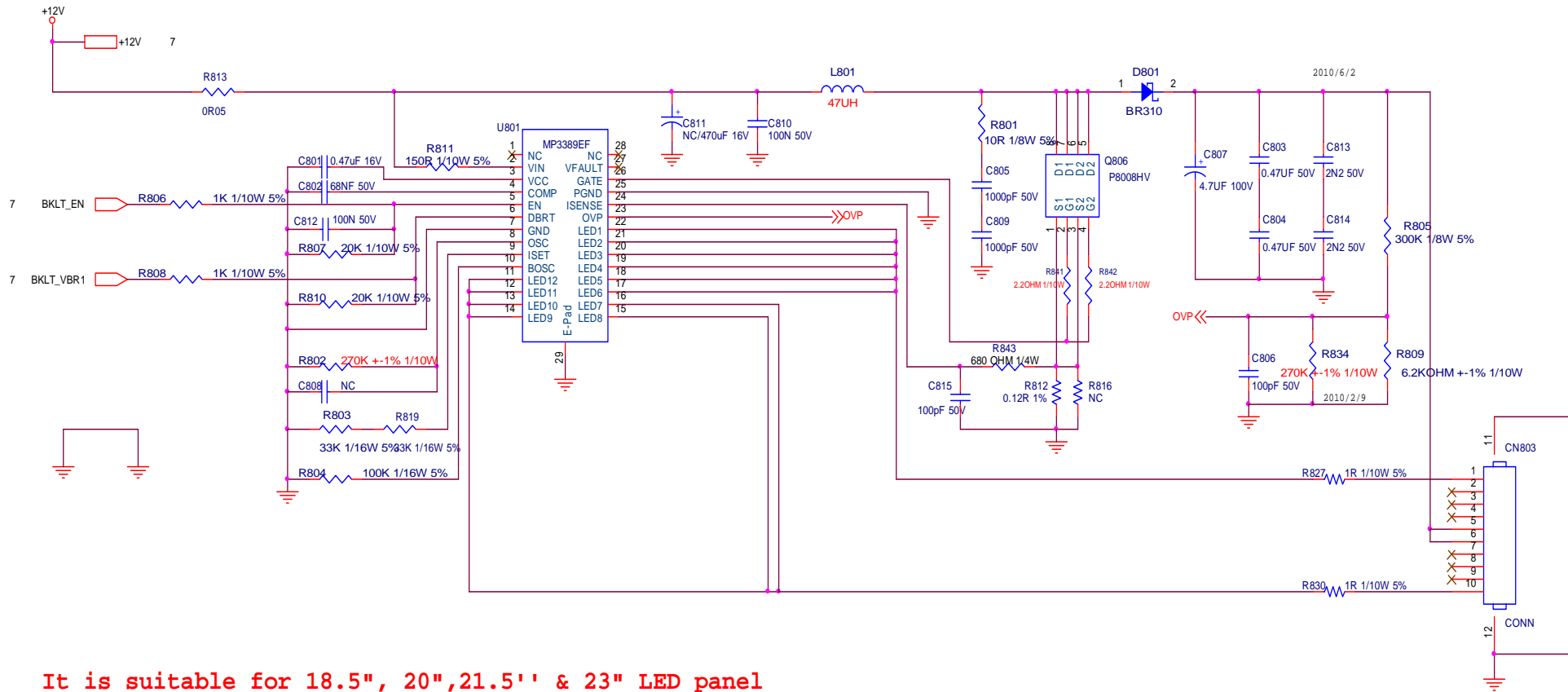

It is suitable for 18.5", 20", 21.5" & 23" LED panel

	190W	200W	215W	230W
R809	6.2K	6.8K	6.2K	6.2K
R834	NC	270K	270K	39K
R812	0.15 ohm	0.15 ohm	0.12 ohm	0.2 ohm
R816	NC	NC	NC	0.2 ohm



TPV (Top Victory Electronics Co., Ltd.)	OEM MODEL	AOC 50ID	Size	Custom
錫蘭瓜網版	715G4798-M0A-000-0040_101101	TPV MODEL	AOC 50ID	Rev
Key Component	CONVERT	PCB NAME		務審
Date	Thursday, May 12, 2011	Sheet	8 of 8	<務審>

6.2 Key Board 715G4842K0E000004F

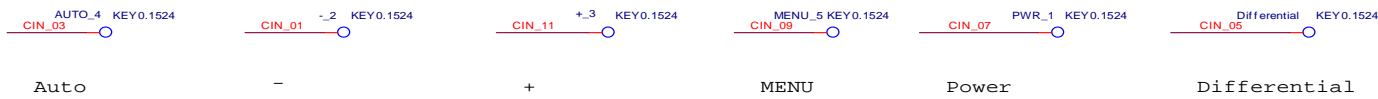
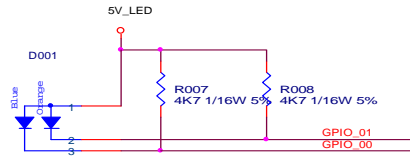
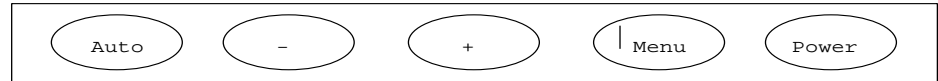
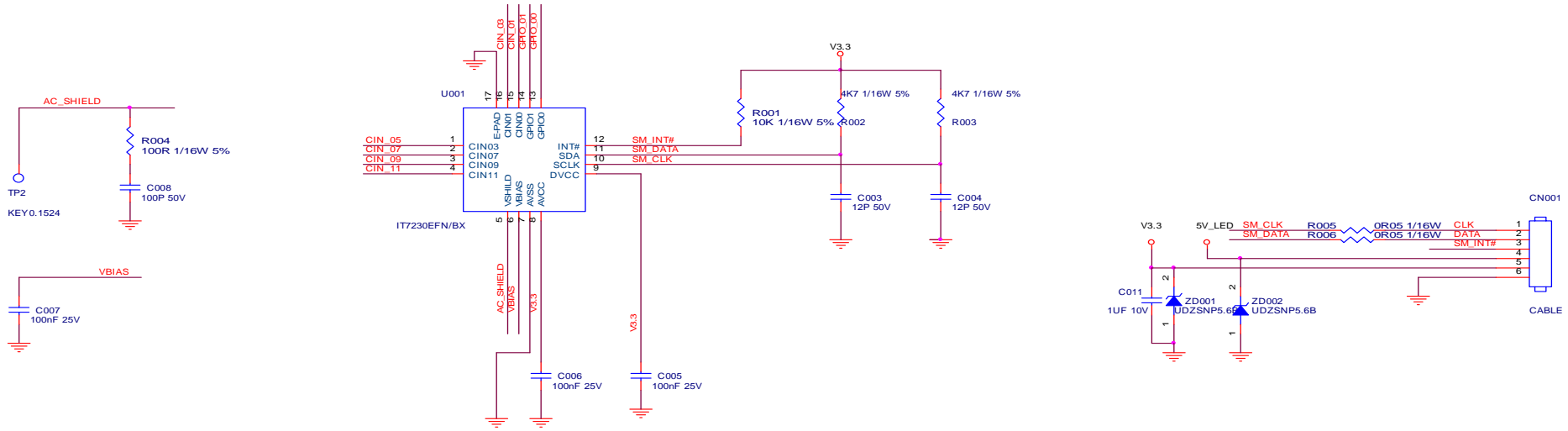

T P V (Top Victory Electronics Co., Ltd.)	OEM MODEL	AOC e943Fw	Size	A3
話筒瓜網膜	715G4164-K0C-000-0040_20100420.DSN	TPV MODEL	e943Fw	Rev
Key Component	2.0 Touch key	PCB NAME	715G4164-K0C	称差
Date	Tuesday, April 19, 2011	Sheet	2 of 2	<称差>

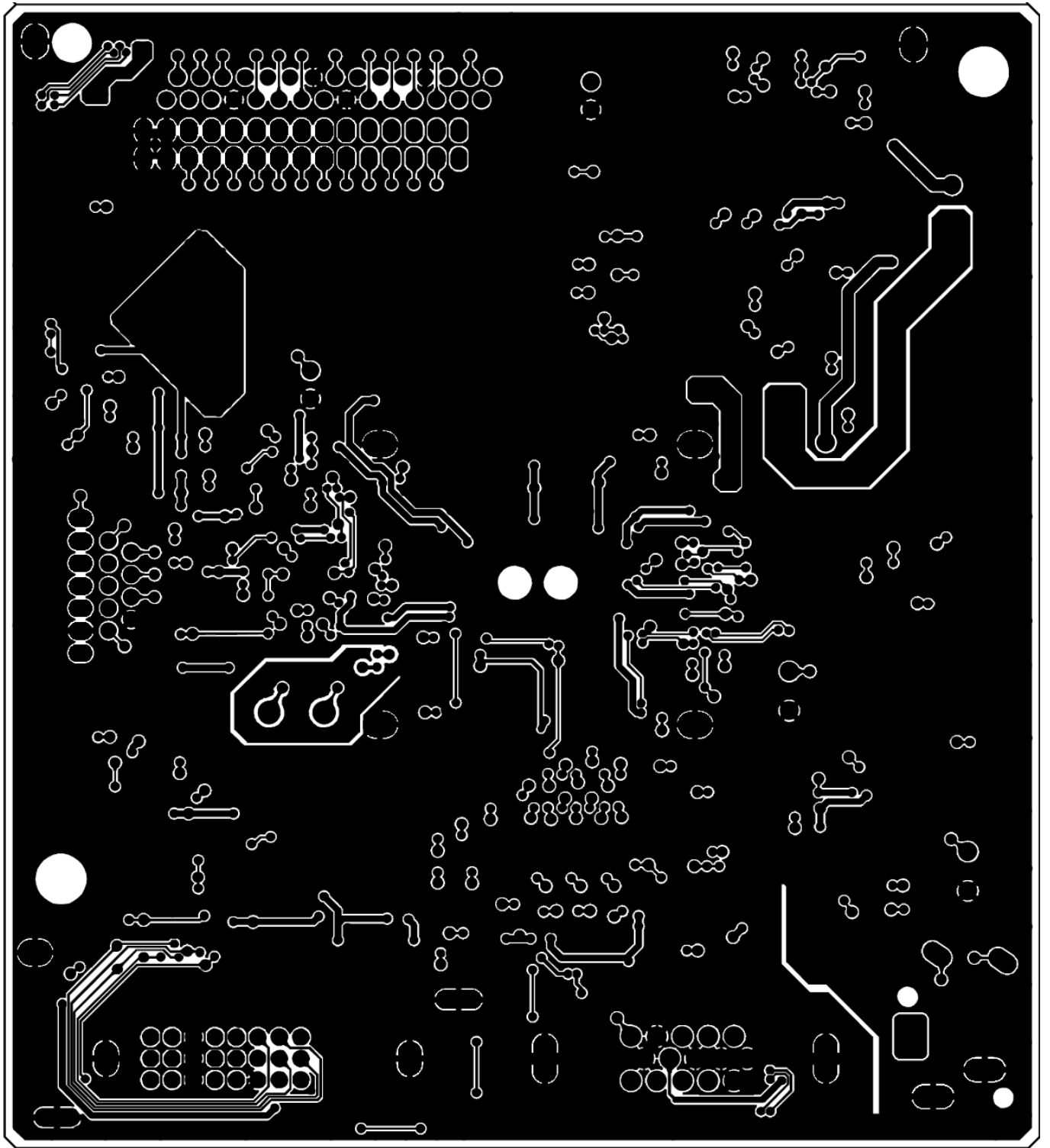

7.2 Key Board

715G4842K0E000004F

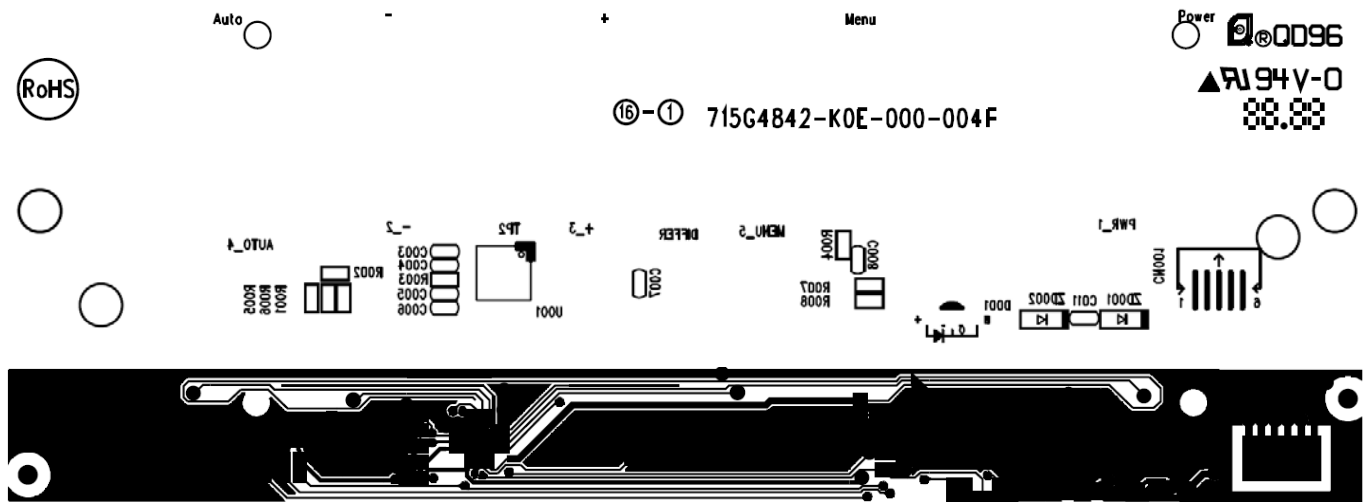

8. Maintainability

8.1 Equipments and Tools Requirement

1. Voltmeter.
2. Oscilloscope.
3. Pattern Generator.
4. DDC Tool with an IBM Compatible Computer.
5. Alignment Tool.
6. LCD Color Analyzer.
7. Service Manual.
8. User Manual.

8.2 Trouble Shooting

1. No Power

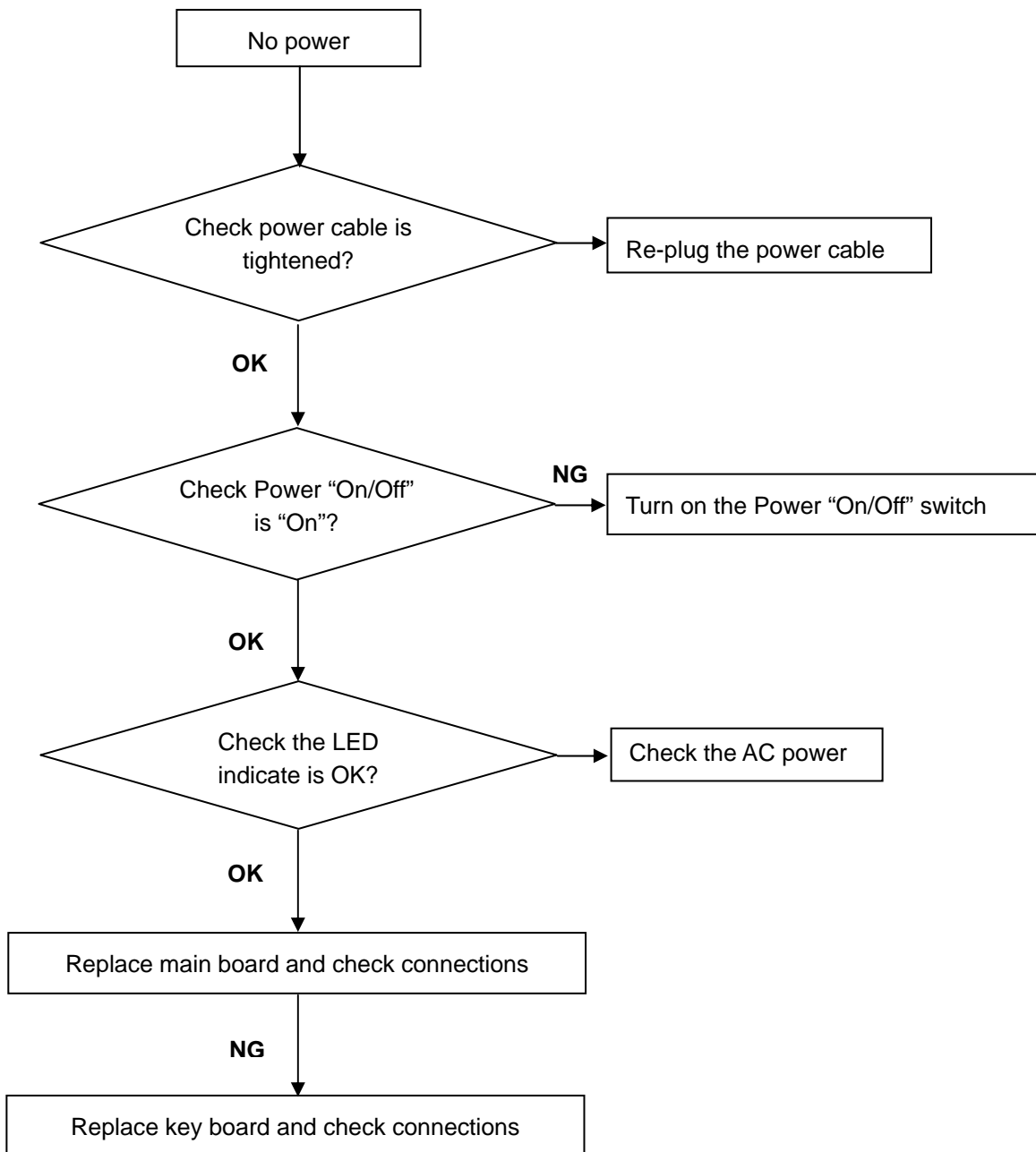

2. No Video (Power LED White)

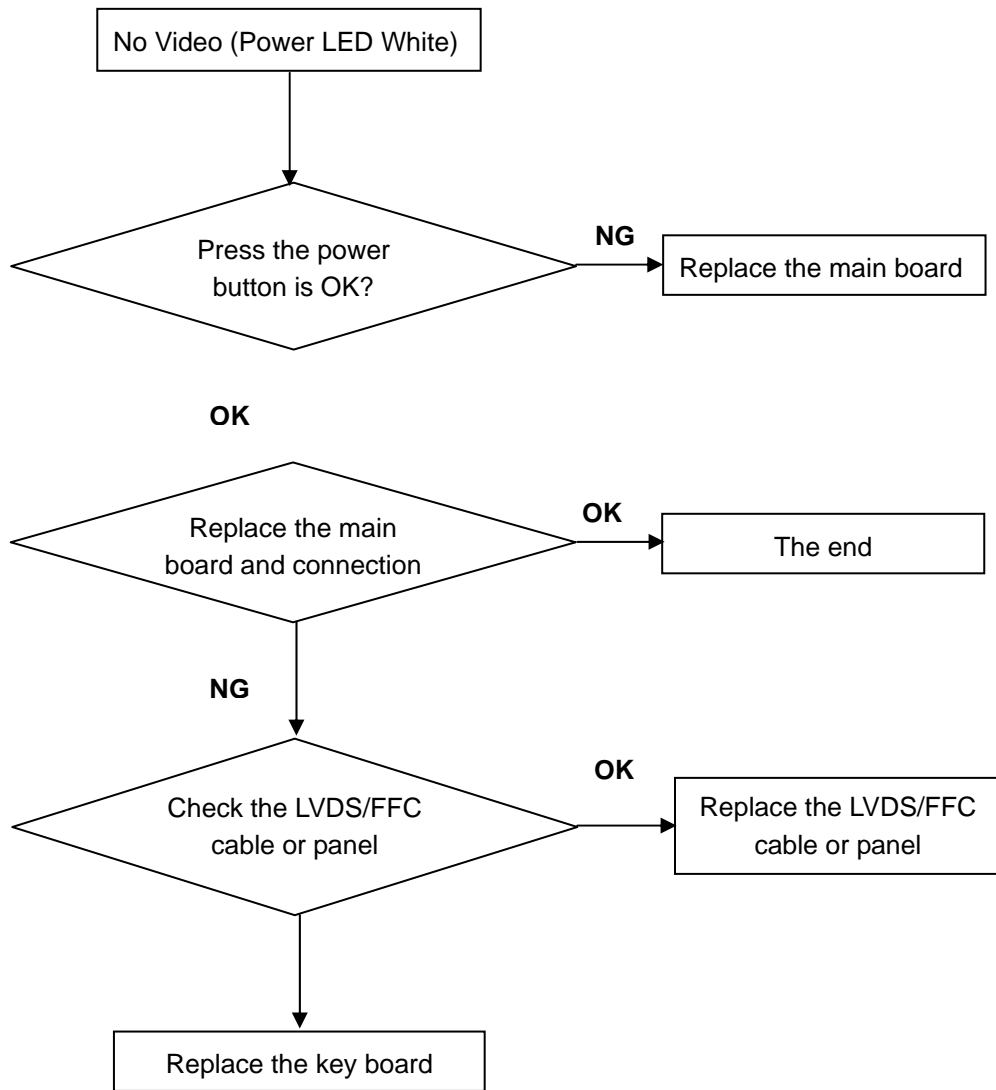

3. DIM

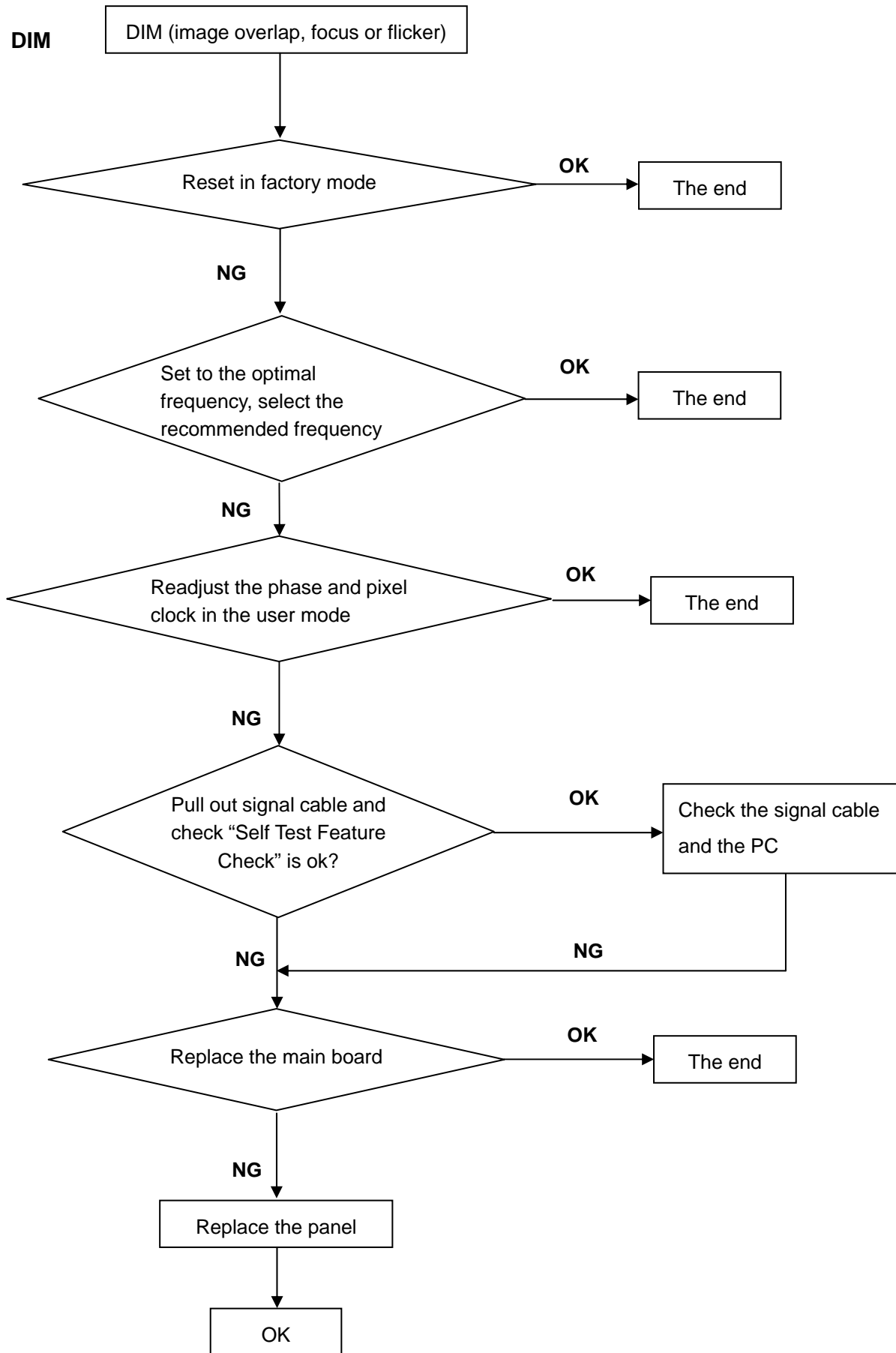

4. Color is not optimal

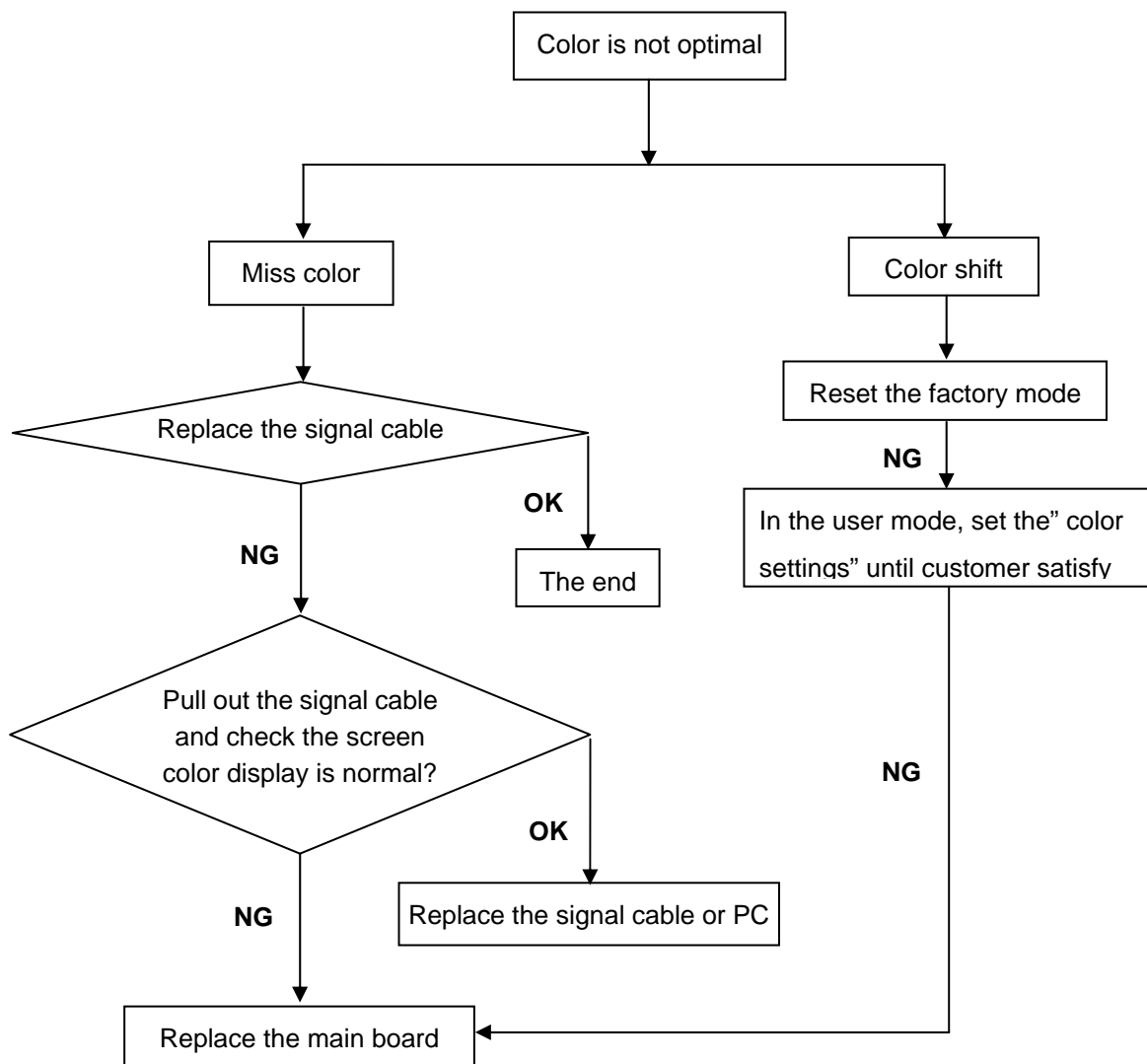

9. White- Balance, Luminance Adjustment

Approximately 30 minutes should be allowed for warm up before proceeding white balance adjustment.

How to setting MEM channel you can reference to chroma 7120 user guide or simpl use "SC" key and "NEXT" Key to modify xyY value and use "ID" key to modify the TEXT description Following is the procedure to do white-balance adjust .

2. Setting the color temp. you want

A. MEM.CHANNEL 3 Warm (6500K):

Warm color temp. parameter is $x = 313 \pm 30$, $y = 329 \pm 30$

B. MEM.CHANNEL 4 Normal (7300K):

Normal color temp. parameter is $x = 301 \pm 30$, $y = 317 \pm 30$

C. MEM.CHANNEL 9 Cool (9300K):

Cool color temp. parameter is $x = 283 \pm 30$, $y = 297 \pm 30$

D. MEM.CHANNEL 10 (sRGB color):

sRGB color temp. parameter is $x = 313 \pm 30$, $y = 329 \pm 30$

3. Enter into the factory mode

Turn off the power, press two direction keys and turn the power on. Then press the "MENU" button. The factory OSD will appear.

4. Gain adjustment:

Move cursor to "-F-" and press MENU key

A. Adjust Warm (6500K) color-temperature

1. Switch the chroma-7120 to **RGB-Mode** (with press "MODE" button)
2. Switch the MEM.channel to Channel 3 (with up or down arrow on chroma 7120)
3. The LCD-indicator on chroma 7120 will show $x = 313 \pm 30$, $y = 329 \pm 30$
4. Adjust the RED on factory window until chroma 7120 indicator reached the value R=100
5. Adjust the GREEN on factory window until chroma 7120 indicator reached the value G=100
6. Adjust the BLUE on factory window until chroma 7120 indicator reached the value B=100
7. Repeat above procedure (item 4, 5, 6) until chroma 7120 RGB value meet the tolerance =100±2

B. Adjust Normal (7300K) color-temperature

1. Switch the chroma-7120 to **RGB-Mode** (with press "MODE" button)
2. Switch the MEM.channel to Channel 4 (with up or down arrow on chroma 7120)
3. The LCD-indicator on chroma 7120 will show $x = 301 \pm 30$, $y = 317 \pm 30$
4. Adjust the RED on factory window until chroma 7120 indicator reached the value R=100
5. Adjust the GREEN on factory window until chroma 7120 indicator reached the value G=100
6. Adjust the BLUE on factory window until chroma 7120 indicator reached the value B=100
7. Repeat above procedure (item 4, 5, 6) until chroma 7120 RGB value meet the tolerance =100±2

C. Adjust Cool (9300K) color-temperature

1. Switch the Chroma-7120 to **RGB-Mode** (with press "MODE" button)
2. Switch the MEM. Channel to Channel 9 (with up or down arrow on chroma 7120)
3. The LCD-indicator on chroma 7120 will show $x = 283 \pm 30$, $y = 297 \pm 30$
4. Adjust the RED on factory window until chroma 7120 indicator reached the value $R=100$
5. Adjust the GREEN on factory window until chroma 7120 indicator reached the value $G=100$
6. Adjust the BLUE on factory window until chroma 7120 indicator reached the value $B=100$
7. Repeat above procedure (item 4, 5, 6) until chroma 7120 RGB value meet the tolerance $=100 \pm 2$

D. Adjust sRGB color-temperature

1. Switch the chroma-7120 to **RGB-Mode** (with press "MODE" button)
2. Switch the MEM.channel to Channel 10 (with up or down arrow on chroma 7120)
3. The LCD-indicator on chroma 7120 will show $x = 313 \pm 30$, $y = 329 \pm 30$
4. Adjust the RED on factory window until chroma 7120 indicator reached the value $R=100$
5. Adjust the GREEN on factory window until chroma 7120 indicator reached the value $G=100$
6. Adjust the BLUE on factory window until chroma 7120 indicator reached the value $B=100$
7. Repeat above procedure (item 4, 5, 6) until chroma 7120 RGB value meet the tolerance $=100 \pm 2$

E. Turn the Power-button off to quit from factory mode.

10. Monitor Exploded View

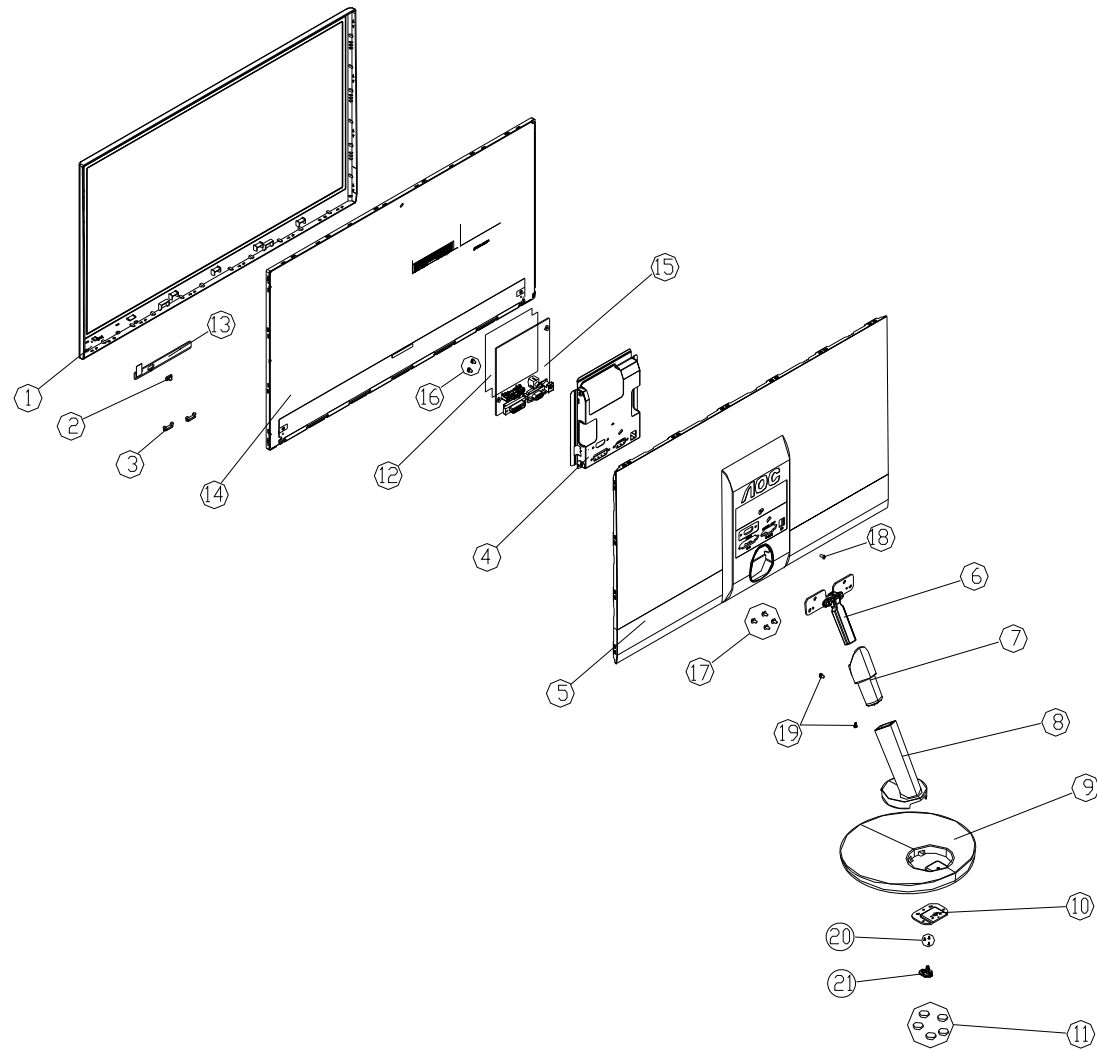

No.	Description
1	BEZEL
2	Power lens
3	RUBBER FEET
4	Main frame
5	Rear cover
6	Hinge
7	Stand
8	Stand cover

No.	Description	No.	Part No.	Description
9	Base			
10	Stand plate	16	0D1G1030--8120	SCREW(MAIN BOARD/MAIN FRAME)
11	RUBBER FOOT	17	0Q1G-140-10120	SCREW(REAR COVER/HINGE)
12	MYLAR	18	0M1G3130--5-47-CR3	SCREW(REAR COVER/MAIN FRAME)
13	KEY BOARD	19	0M1G1730--8225-CR3	SCREW(STAND/HINGE)
14	PANEL	20	0Q1G1030--6120	SCREW(STAND PLATE/BASE)
15	MAIN BOARD	21	F01G6064--4	SCREW(STAND PLATE/HINGE)

11. BOM List

Note: The parts information listed below are for reference only, and are subject to change without notice. Please go to <http://cs.tpv.com.cn/hello1.asp> for the latest information.

TIBJT32CB7SUHNF.LF

点位	组件	对象描述	备注
	040G-58162435A	P/N LABEL FOR MANUAL PE BAG	
	040G-58162461A	Energy star label	
	040G-581689-4A	BARCODE LABEL FOR 1 (58x35mm)	
	052G---1210--A	80MM * 25MM	
	052G---2191--A	PAPER TAPE	
	052G6019--1	INSULATING TAPE	
E08902	089G-725CAA-DB	SINGAL CABLE 1500MM COMLINK	
	089G-725HAA-DB	SINGAL CABLE 1500MM HONGLIN	2nd SOURCE
	089G-725GAA-DB	SINGAL CABLE 1500MM GREATLAND	2nd SOURCE
E08903	089G1745CAA-AC	DVI CABLE 1500MM COMLINK	
	089G1745HAA-AC	DVI CABLE 1500MM HONGLIN	2nd SOURCE
	089G1745GAA-AC	DVI CABLE 1500MM GREATLAND	2nd SOURCE
	0D1G1030--8120	screw	
	0M1G1730--8225-CR3	screw(Hinge)	
	0M1G3130--5-47-CR3	SCREW M3 x5	
	0Q1G-140-10120	SCREW	
	0Q1G1030--6120	SCREW	
	708GBG01-CP-3A	AOC 40(2200)	
	Q45G--77--4	PE FILM	
	Q50G---4-10	TIE (Y1900221)	
	Q52G---1185-98	3M TAPE	
E750	750GBT215W4BB1N20 0	PANEL BM215WF4-T2BB	
	750GBT215W4BB1N10 0	PANEL BM215WF4-T2BB	2nd SOURCE
	2436L-2518B	BM215WF4-T2BB-632	

	3110T-0856A	GALVALUME, T=0.3,BM215WF4-TJA1-6F1-A0, Up	
	3110T-0856B	GALVALUME, T=0.3,BM215WF4-TJA1-6F1-A0, Down	
	3850L-0088A	ID, YUPO, 78X37	
	4296L-0284B	PMP-P2 100-520U-13, 5U-C60 black A600, 170x7x0.45	
	6060L-2569A	LM215WF4(TJBA,T2BB)	
	6061L-2064A	LM215WF4-TJAA	
	01LUL-0185A	LS0609D3-C6LS, LUSEM, 960, 6BIT, MINI, C_B, R/TP, 48MM, 4PF, UPILEX, T9	
	6308L-4013A	LTBXNSSNXX1-02150T01, 487.1*277.5, LGC,T,B,X,N,S, S,N,X,X,1,02150,Top,01	
	6308L-4014A	LTXNSSNXX1-02150B01, 487.10*277.5, LGC, T, X, X, N, S, S, N, X, X, 1, 02150, Bottom, 01	
	6871L-2552B	Source, Single, None-C/SKD, LM215WF4-TJC1, Single Side	
C115	0CH2103K562	10NF, K, 50V, X7R, 0.9mm, 1608, R/TP	
C915,C916	0CH2104H942	0.1uF, Z, 25V, Y5V, 0.9mm, 1608, R/TP	
C1,C2,C302,C 5,C51,C6,C7,C 8,C924	0CH2104K562	0.1UF 50V K X7R 1608 R/TP	
C79,C911	0CH2473H562	47nF, K, 25V, X7R, 0.9mm, 1608, R/TP	
C56,C57,C74	0CH2473K562	47NF 50V K X7R 1608 R/TP	
C3,C36,C4,C9 08	0CH2A-0007A	1U F, 10 Volt, K PER, X5R(JB), 1608 R/TP, T=0.9(MAX)	
C50,C55,C58, C59	0CH2A-0010A	33nF, M, 25V, X7R, 0.9mm, 1608, R/TP	
C22,C23,C32, C33,C34	0CH2A-0011A	10U F, 16 Volt, K PER, X5R(JB), 3216 R/TP, T=0.95(MAX)	
C101,C102,C1 03,C104,C105, C106,C107,C1 08,C109,C110, C111,C112,C1 13,C114,C301, C303,C305,C3 07,C309,C311,	0CH2A-0015A	1uF, K, 25V, X5R, 0.9mm, 1608, R/TP	

C77,C907			
C73	0CH2A-0017A	2.2U F, 10 Volt, K PER, X5R(JB), 1608 R/TP, T=0.9(MAX)	
C313,C314,C315,C318,C52,C61,C62,C63,C64,C71,C72,C913,C914,C920,C921	0CH2A-0026A	10U F, 25 Volt, K PER, X5R(JB), 3225 R/TP, T=1.0(MAX)	
C312	0CH2A-0038A	0.1U F, 25 Volt, Z PER, Y5V(JF), 1005 R/TP, T0.55(MAX)	
C701	0CH2A-0049A	1.5nF, 50, -10~+10(K), 1608, X7R(JB)	
C75	0CH2A-0088A	3.3nF, K, 50V, X7R, 0.9mm, 1608, R/TP	
C912	0CH2A-0091A	1uF, K, 25V, X5R, 0.6mm, 1005, R/TP	
D3,D4,D5	0DHZL-0008B	BAV99-7-05-F, DIODES, SOT-23, R/TP	
ZD1	0DHZL-0061A	SDZ6V2D, AUK, SOD-323, R/TP	
D6	0DHZL-0095A	RB050M-30, ROHM, PMDU, R/TP	
F1	0FFST-0002A	F0603FA2500V032T, AEM, 2.5, 32 Volt, 1.6X0.8X0.8, SMT, Ceramic, UL/CSA	
U3	0IDIL-0002A	AP7167-FNG-7, DIODES, ADJUST_3.3V, 1.2A, DFN3030-10, R/TP, 10	
UC2	0IIML-0004A	iML7821BE, IML, 5V~20V, 320mA, 20V/us, 40MHz, 1Ch, TSOT, R/TP, 5Pin	
U4	0ISGL-0008C	M24C04-RDW, STmicroelectronics, 4K, 5ms, TSSOP, R/TP, 8	
US2	0ISML-0007A	SM4025, SILICON MITUS, MONITOR, BOOST+L/S(GPM)+OP-AMP+PVCOM+DISCHARGING,	
UC1	0ISWL-0078A	SW0640, SIW, LVDS, 6/8, 2, MINI-LVDS, 6, 1, DRD, GIP, AFRC, DGA, MUTE, MLF, TR, 68	
L1	0LCAA-0069B	TNI8016-100M, DACOWELL, 10UH, M=20%, 2.1A, 0.093, 8.0X11.0X1.8 (1.2MM, IN-BOARD), R/TP	
FL4,FL5,R103,R109,R118,R119,R121,R125,R126,R127,R129,R138,R139,	0RH0000C622	0 OHM 1/16W 1608 5% D R/TP	

R140,R142,R179,R180,R20,R302,R54,R601,R602,R801,R802,R901,R902,R903,R906,R908			
R131	0RH0102C422	10 OHM 1/16W 1608 1% D R/TP	
R701	0RH0221C622	2.2 OHM 1/16W 1608 5% D R/TP	
R10,R11,R12,R13,R14,R15,R16,R17,R18,R19,R22,R23,R25,R26	0RH0302C422	30 OHM 1/16W 1608 1% D R/TP	
R322	0RH0472C422	47 OHM 1/16W 1608 1% D R/TP	
R2,R3	0RH1000C422	100 OHM 1/16W 1608 1% D R/TP	
R1	0RH1001C422	1K OHM 1/16W 1608 1% D R/TP	
R24,R55	0RH1002C422	10K OHM 1/16W 1608 1% D R/TP	
R123,R225,R235,R244,R255	0RH1102C422	11K OHM 1/16W 1608 1% D R/TP	
R214	0RH1201C422	1.2K OHM 1/16W 1608 1% D R/TP	
R212	0RH1202C422	12K OHM 1/16W 1608 1% D R/TP	
R211	0RH1301C422	1.3K OHM 1/16W 1608 1% D R/TP	
R150	0RH1500C422	150 OHM 1/16W 1608 1% D R/TP	
R151,R242,R27	0RH1502C422	15K OHM 1/16W 1608 1% D R/TP	
R114,R136	0RH1601C422	1.6K OHM 1/16W 1608 1% D R/TP	
R130,R233,R77	0RH1602C422	16K OHM 1/16W 1608 1% D R/TP	
R141	0RH1800C422	180 ohm, 1/16W, 1608, 1%, R/TP	
R115	0RH2201C422	2.2K OHM 1/16W 1608 1% D R/TP	
R50,R51	0RH2401C422	2.4K OHM 1/16W 1608 1% D R/TP	
R904	0RH2402C422	24K OHM 1/16W 1608 1% D R/TP	
R101,R104,R106,R261	0RH2700C422	270 OHM 1/16W 1608 1% D R/TP	

R243,R253	0RH2702C422	27K OHM 1/16W 1608 1% D R/TP	
R148,R223,R234,R245	0RH3302C422	33K OHM 1/16W 1608 1% D R/TP	
R135	0RH3602C422	36K 1/16W 1% 1608	
R201	0RH3900C422	390 OHM 1/16W 1608 1% D R/TP	
R146	0RH3902C422	39K OHM 1/16W 1608 1% D R/TP	
R324,R326,R67	0RH4700C422	470 OHM 1/16W 1608 1% D R/TP	
R202	0RH4702C422	47K OHM 1/16W 1608 1% D R/TP	
R110,R132,R778,R905	0RH5101C422	5.1K OHM 1/16W 1608 1% D R/TP	
R117	0RH5102C422	51K OHM 1/16W 1608 1% D R/TP	
R203	0RH5600C422	560 ohm, 1/16W, 1608, 1%, R/TP	
R122,R124,R4,R5,R909	0RH5601C422	5.6K OHM 1/16W 1608 1% D R/TP	
R222	0RH5602C422	56K OHM 1/16W 1608 1% D R/TP	
R252	0RH6201C422	6.2K OHM 1/16W 1608 1% D R/TP	
R254	0RH6202C422	62K OHM 1/16W 1608 1% D R/TP	
R232	0RH7502C422	75K ohm, 1/16W, 1608, 1%, R/TP	
R21,R231,R241,R251	0RH8201C422	8.2K OHM 1/16W 1608 1% D R/TP	
R221	0RH9101C422	9.1K OHM 1/16W 1608 1% D R/TP	
R910	0RH9102C422	91K OHM 1/16W 1608 1% D R/TP	
R224	0RHAA-0015A	43K ohm, 1/16W, 1608, 1%, R/TP	
AR5,AR6	0RHZL10005A	100OHM 5 1/16W 3216 R/TP	
Q2	0TRRL-0010A	KTA1505S-Y-RTK/H, KEC, PNP, R/TP, SOT-23, .	
	0TRRL-0019A	MMBT4403, Diodes, PNP, R/TP, SOT-23, H/F, 3	2nd SOURCE
Q1	0TRRL-0011A	KTC3876S-Y-RTK/H, KEC, NPN, R/TP, SOT-23, .	
	0TRRL-0020A	MMBT4401, Diodes, NPN, R/TP, SOT-23, H/F, 3	2nd SOURCE
FL6,FL7,FL8,FL9	6200L-J015A	BLM18PG300SN1D	
RT1	6322L-0004A	22K ohm, +-3%, 125, 0.21, 3950, 1608, R/TP	

CN1	6630L-0157B	FI-XB30SL-HF10, JAE, 30 Pin, 1 mm, Angle, Sn, USER LOCK	
	6630L-0410A	IS100-L30F-C15, UJU, 30 Pin, 1 mm, Angle, Sn, USER LOCK	2nd SOURCE
	6870S-1235A	LM215WF4-TJC1-611, 2L, 0.6, 479.15*122.15, 3, N, Source, NO, Single Side	
E2436L	6091L-1904D	BM215WF4-T2AA	
	6091L-1904B	BM215WF4-T2AA	2nd SOURCE
	3022L-1413A	KOLON, XC210, T=0.123, BM215WF4-TJA1-6F1-A0	
	3022L-1413B	LUCKY, CDX131, T=0.21, BM215WF4-TJA1	
	3550B-0918A	AL, T=0.5, BM215WF4-TJA1-6F1-A0	
	3850L-0151A	BL, YUPO, 77X21	
	4975L-0464A	BM215WF4-TJA1-6F1-A0	
	4974L-0864A	PC,ENTIRE,ETR-1010,V0, BM215WF4-TJA1-6F1-A0	
	5022L-0302A	SH140U+5256M, SILICON, Gray, 274.7*2.0*0.4	
	5022L-0303A	SH140U+5256M, SILICON, Gray, 485*2.0*0.4	
	5151L-0218A	BM215WF4-TJA1-6F1-A0	
	3034L-0937A	TORAY, TZC25S, T=0.25, 3M, 1363-60, BM215WF4-TJA1-6F1-A0	
	3953L-0217A	TORAY, 188E60L, T=0.188, 3M, 1363-60, 441.7*1.8*0.2, BM215WF4-TJA1-6F1-A0	
	3953L-0218A	TORAY, 188E60L, T=0.188, 3M, 1363-60, 286*1.8*0.2, BM215WF4-TJA1-6F1-A0	
	5150L-0595A	PMMA, Flat, 2.0, Printing, BM215WF4-TJA1-6F1-A0	
	6916L-0539C	EverTop, LED, 32(Number Of LED), White LED, BM215WF4-TJA1	
	5153L-0068A	10FH-SM1-GAN-TB(LF)(SN) , JST	
	6915L-0284C	Ever Top LED,WM32NW1F,Top View,2ea(LED Chip Q'TY per PKG), 7020PKG	
	6920L-0064A	283.4*4.2*1.2, 2ea(Number Of Chain), 1L(Number Of Layer), 32ea(Number Of LED), AL	
	7250L-1401B	TP-15;282.6*3.6*0.25T	
	7250L-0864A	NITTO, NITTO 5000NS, Clear, 30*3*0.16	

	7250L-1408A	ZH350 25x16x0.1	
	7250L-1488B	Conductive Tape,STN1026WR(P), T=0.11, 15*25*0.11	
	756GFBCB-AA016--00	MAINBOARD-CBPCAT3A1AX	
SMTCA-U403	100GARJI004FT1	MCU ASS' Y-056G2233-11	
	A15G1636101	MAIN_FRAME	
	A15G1648101	PIATE	
	A33G1203AED-1B0100	stand-top	
	A33G1204--1-1C0100	Power lens	
	A34G2579AEDD1B013 0	BEZEL	
	A34G2580AED-1B0100	rear cover	
	A34G2581AED-1B0100	Stand-cover	
	A34G2618AED-1B0130	BASE	
	A37G0252011	HINGE	
CN406	033G801930F-CH---L	WAFER 30P 1.0MM XIANGLONG	
	033G801930F-CH--JS	WAFER 30P 1.0MM JINGSHI	2nd SOURCE
C716	067G204V471-2L	CS CAP 470uF +-20% 10V 8*8 LELON	
	067G204V471-2K	CS CAP 470uF 10V 8*8 mm	2nd SOURCE
C718,C811	067G215C151-4H	EC 150uF +-20% 25V 8*7mm 700mA 2000Hr HER MEI	
C807	067G415R479-9L	EC 4.7UF 20% 100V RZW 8*12	
	067G415R479-9K	EC 4.7UF 20% 100V ED 8*12	2nd SOURCE
FB701	071G--5526A--H	CORE 6.0X3.5X3.5 127 25% 3.5X6.0	
	071G--5526A--S	CORE 6.0X3.5X3.5 127 25%	2nd SOURCE
CN101	088G-35315FVXH	D-SUB CONN WITH SCREW 15P BLUE XIANHE	
	088G-35315FVCL	D-SUB CONN WITH SCREW 15P BLUE CL	2nd SOURCE
CN102	088G354GOF1VXH	DVI CONN WITH SCREW 24P WHITE XIANHE	
X401	093G--22-53--J	Diode CRY 14.31818MHZ/32PF/49US NSK	
	709G4798-QM001	COMSUPTIVE ASS""Y	

	055G--23524--A	WELDING FULX WITHOUT Pb	
	Q49G--51100	GW2066 Cleaner	
	Q55G-100625	TIN STICK_LOW ARGENTUM	
C141,C707	F67G305M1013GV	100uF +-20% 16V 105 °C 2000H 6.3*7	
	067G305S1013HV	EC 100UF 20% 16V 6.3*7	2nd SOURCE
CN701	F88G-304-11-YG	DC JACK 3P BLACK YCG	
	088G-304-11--C	DC JACK 3P BLACK CL	2nd SOURCE
CN803	033G801910Y--H	NO-SUGGEST WAFER 10P 0.5MM GAOLIN	
	311GF050B10ADH	FFC CONN 10P 0.5MM HR	2nd SOURCE
U401	056G-562434	IC SCALER RTD2281W-CG QFP-128 Realtek	
U702	056G-563512--C	IC LDO G1117-33PT43U 1A 3.3V TO-252 GMT	
	056G-563512	NO-SUGGEST IC LDO G1117-33T43UF 1A/3.3V TO-252 GMT	2nd SOURCE
	056G-563520	NO-SUGGEST IC LDO LSP1117D33AG 1A 3.3V TO-252 LITEON	2nd SOURCE
U102,U103,U104,U106,U107	056G-662-48	IC ESD PROTECT AZC399-04S SOT23-6L AMAZING	
	056G-662-49	NO-SUGGEST IC ESD PROTECT L30ESDL5V0C6-4 SOT23-6L LITEON	2nd SOURCE
U801	056G-700--5	IC LED DRIVER MP3389EF TSSOP28 MPS	
U101,U105	056G1133158	IC EEPROM CAT24C02WI-GT3A 2Kb SOIC-8 ON	
	056G1133531	NO-SUGGEST IC EEPROM FM24C02A-SO-T-G 2K SOP-8 FUDAN	2nd SOURCE
	056G1133-34--1	IC EEPROM M24C02-RMN6TP 2Kb SO-8 ST	2nd SOURCE
U403	056G2233-11	IC FLASH Pm25LD020C-SCE SIOC-8 2M PMC	
Q402,Q404	057G-417517	TRA LMBT3906LT1G -0.2A/-40V SOT-23 LRC	
	057G-417512	TRA MMBT3906 0.2A/40V SOT-23 BLUE ROCKET	2nd SOURCE
Q701,Q706	057G-417518	TRA LMBT3904LT1G 0.2A/40V SOT-23 LRC	
	057G-417511	TRA MMBT3904 0.2A/40V SOT-23 BLUE ROCKET	2nd SOURCE
Q806	057G-763-92	MOSFET P8008HV 4A/80V SOP-8 NIKO-SEM	

Q705	057G-763535	MOSFET LP3401LT1G -4.2A/-30V SOT-23 LRC	
	057G-763940	MOSFET AO3401A 4.2A/30V SOT-23 AOS	2nd SOURCE
R419,R421,R424,R425,R439,R444,R448,R452,R453,R483	061G0402000-JT	RST CHIPR MAX0R05 1/16W TZAI YUAN	
R104,R109,R116,R131,R132,R133,R134,R135,R136,R137,R138	061G0402100-JT	RST CHIPR 10 OHM +-5% 1/16W 0402 TZAI YUAN	
R120,R121,R422,R479,R480,R481,R482,R706	061G0402101-JT	RST CHIPR 100 OHM +-5% 1/16W 0402 TZAI YUAN	
R127,R142,R149,R150	061G0402102-JT	RST CHIPR 1 KOHM +-5% 1/16W 0402 TZAI YUAN	
R416,R428,R435,R702,R703,R719	061G0402103-JT	RST CHIPR 10 KOHM +-5% 1/16W 0402 TZAI YUAN	
R437,R712,R721,R804	061G0402104-JT	RST CHIPR 100 KOHM +-5% 1/16W 0402 TZAI YUAN	
R427,R429,R431,R433	061G0402220-JT	RST CHIPR 22 OHM +-5% 1/16W 0402 TZAI YUAN	
R122,R123,R445	061G0402222-JT	RST CHIPR 2.2 KOHM +-5% 1/16W 0402 TZAI YUAN	
R720	061G0402223-JI	RST CHIPR 22 KOHM +-5% 1/16W 0402 TA-I	
R114,R130,R704	061G0402223-JT	RST CHIPR 22 KOHM +-5% 1/16W 0402 TZAI YUAN	
R438	061G0402224-JT	RST CHIPR 220 KOHM +-5% 1/16W 0402 TZAI YUAN	
R726	061G0402303-JT	RST CHIPR 30 KOHM +-5% 1/16W 0402 TZAI YUAN	
R711,R803,R819	061G0402333-JT	RST CHIPR 33 KOHM +-5% 1/16W 0402 TZAI YUAN	
R436	061G0402394-JF	RST CHIPR 390 KOHM +-5% 1/16W 0402 FENGHUA	
R101,R105,R107,R111,R118,R125,R126,R4	061G0402470-JT	RST CHIPR 47 OHM +-5% 1/16W 0402 TZAI YUAN	

77,R478			
R112,R113,R128,R129,R415,R420,R451,R459,R467,R475,R476,R705,R718	061G0402472-JT	RST CHIPR 4.7 KOHM +-5% 1/16W 0402 TZAI YUAN	
R106,R110,R117	061G0402750-JT	RST CHIPR 75 OHM +-5% 1/16W 0402 TZAI YUAN	
FB101,R119,R455	061G0603000-JT	RST CHIP MAX 0R05 1/10W TZAI YUAN	
R713	061G0603100-JT	RST CHIPR 10 OHM +-5% 1/10W 0603 TZAI YUAN	
R714	061G06031002FF	RST CHIPR 10 KOHM +-1% 1/10W 0603 FENGHUA	
R806,R808	061G0603102-JT	RST CHIPR 1 KOHM +-5% 1/10W 0603 TZAI YUAN	
R827,R830	061G0603109-JT	RST CHIPR 1 OHM +-5% 1/10W 0603 TZAI YUAN	
R811	061G0603151-JT	RST CHIPR 150 OHM +-5% 1/10W 0603 TZAI YUAN	
R446	061G0603201-JT	RST CHIPR 200 OHM +-5% 1/10W 0603 TZAI YUAN	
R807,R810	061G0603203-JT	RST CHIPR 20 KOHM +-5% 1/10W 0603 TZAI YUAN	
R841,R842	061G0603229-JT	RST CHIPR 2.2 OHM +-5% 1/10W 0603 TZAI YUAN	
R802,R834	061G06032703FF	RST CHIPR 270 KOHM +-1% 1/10W 0603 FENGHUA	
R715	061G06035362FF	RST CHIPR 53.6KOHM +-1% 1/10W 0603 FENGHUA	
R430,R809	061G06036201FF	RST CHIPR 6.2 KOHM +-1% 1/10W 0603 FENGHUA	
R801	061G0805100-JT	RST CHIP 10R 1/8W 5% TZAI YUAN	
R805	061G0805304-JT	RST CHIP 300K 1/8W 5% TZAI YUAN	
R813	061G12060004JT	RST CHIP MAX 0R05 1/4W TZAI YUAN	
R812	061G12061207FF	RST 1206 0.12R 1% 1/4W FENGHUA	
R146,R147	061G1206301-JT	RST CHIPR 300 OHM 1/4W TZAI YUAN	

R843	061G1206681-JT	RST CHIPR 680 OHM +-5% 1/4W	
C404,C405,C406	065G040210131J---Y	MLCC 0402 100pF +-5% 50V NPO YAGEO	
C113,C114,C115,C117,C118,C119,C142,C402,C403,C408,C409,C410,C411,C414,C417,C419,C422,C708,C709,C717,C721,C725	065G040210412K---A	MLCC 0402 0.1uF +-10% 16V X7R SAMSUNG	
C416,C420	065G0402105A5K---A	MLCC 0402 1uF +-10% 10V X5R SAMSUNG	
	065G0402105A5K---T	MLCC 0402 1uF -10% 10V X5R TAIYO YUDEN	2nd SOURCE
C145,C146,C151,C415,C418,C731	065G040222031J---T	MLCC 0402 22pF +-5% 50V NPO TAIYO YUDEN	
C722	065G040222232K---Y	MLCC 0402 2.2nF +-10% 50V X7R YAGEO	
C147	065G040222322K---Y	MLCC 0402 22nF +-10% 25V X7R YAGEO	
C101,C116,C412,C724	065G040222415K---T	MLCC 0402 0.22uF +-10% 16V X5R TAIYO YUDEN	
C102,C104,C105,C107,C108,C110	065G040247312K---A	MLCC 0402 47nF +-10% 16V X7R SAMSUNG	
C103,C106,C109	065G040250931C---Y	MLCC 0402 5pF +-0.25pF 50V NPO YAGEO	
C710,C714,C805,C806,C809,C815	065G060310131J---A	MLCC 0603 100pF +-5% 50V NPO SAMSUNG	
	065G060310131J---M	MLCC 0603 100pF -5% 50V NPO MURATA	2nd SOURCE
C715	065G060310232K---Y	MLCC 0603 1000pF +-10% 50V X7R YAGEO	
C712,C719,C810,C812	065G060310432K---Y	MLCC 0603 0.1uF +-10% 50V X7R YAGEO	
C713,C728	065G060310525K---T	MLCC 0603 1uF +-10% 25V X5R TAIYO YUDEN	
	065G060310525K---3	NO-SUGGEST MLCC 0603 1uF -10% 25V X5R TDK	2nd SOURCE
C801	065G060347412K---A	MLCC 0603 0.47uF +-10% 16V X7R SAMSUNG	

	065G060347412K---T	MLCC 0603 0.47uF -10% 16V X7R TAIYO YUDEN	2nd SOURCE
C802	065G060368332K---Y	MLCC 0603 68nF +-10% 50V X7R YAGEO	
C413,C424,C4 25	065G0805106A5K---A	MLCC 0805 10uF +-10% 10V X5R SAMSUNG	
	065G0805106A5K---T	MLCC 0805 10uF -10% 10V X5R TAIYO YUDEN	2nd SOURCE
C813,C814	065G080522232K---Y	MLCC 0805 2200pF +-10% 50V X7R YAGEO	
C803,C804	065G080547432K---T	MLCC 0805 0.47uF +-10% 50V X7R TAIYO YUDEN	
	065G080547432K---M	MLCC 0805 0.47uF -10% 50V X7R MURATA	2nd SOURCE
C720,C723	065G120610625K---A	MLCC 1206 10uF +-10% 25V X5R SAMSUNG	
	065G120610625K---T	MLCC 1206 10uF -10% 25V X5R TAIYO YUDEN	2nd SOURCE
U403	070GHDCP500HDC	HDCP CODE	
FB102,FB403, FB404,FB702	071G-56K121--M	CHIP BEAD	
FB408	071G-59C121-TA	CHIP BEAD 0603 120R 25% 300mA FCM1608CF-121T03 TAI-TECH	
	071G-59C121--B	FCM1608C-121T03 SMD	2nd SOURCE
FB103	071G-59G301-TA	CHIP BEAD 300OHM 200mA FCM1608KF-301T02	
FB104,FB105, FB106	071G-59K190-TA	CHIP BEAD 0603 19R 25% 500mA FCB1608KF-190T05 TAI-TECH	
	071G-59K190--B	19 OHM BEAD	2nd SOURCE
L801	073G253S-98-DN	SMD CHOKE 47uH 20% 3A 64R	
	073G253S-98--X	SMD CHOKE 47UH 20% 0.064R 3SMSL12575-470	2nd SOURCE
L701	073G253S521--H	SMD CHOKE 22UH 20% 3.3A HF	
	073G253S521--M	SMD CHOKE	2nd SOURCE
D101,D102	093G--64-42--L	DIODE LBAV70LT1G 0.15A/75V SOT-23 LRC	
	093G--64-42--P	DIODE BAV70 0.5A/100V SOT23 PANJIT	2nd SOURCE
D401,D403,ZD 101,ZD102,ZD 105,ZD106	093G-39GA01--T	DIODE ZD RLZ5.6B 5.6V/0.5W SEMTECH	

ZD703	093G-39GA52--T	DIDOE ZD ZM-PTZ9.1BST 9.1V/1W LL-41 SEMTECH	
D801	093G-60S907--T	Diode SCHOTTKY B3100B 3A 100V SMB LITEON	
D701	093G3004--2	DIODE SCHOTTKY SR34 3A/40V SMB PANJIT	
CN405	311GF100C06ADH	FFC CONN 6P 1.0mm HR	
U705	356G0563419	IC LDO DC/DC APW7089KAI-TRG 4A 26V SOP-8P ANPEC	
	056G-563513	NO-SUGGEST IC LDO APW7080KAITRG 4A/26V SOP-8P ANPEC	2nd SOURCE
	709G4798-QS001	COMSUPTIVE ASS""Y	
	052G---2191--A	PAPER TAPE	
E715	715G4798M01000004L	MAIN PCB FR-4 92*102mm*1.6mm 6	
	715G4798M01000004S	MAIN PCB FR-4 92*102mm*1.6mm 6	2nd SOURCE
	715G4798M01000004I	MAIN PCB FR-4 92*102mm*1.6mm 6	2nd SOURCE
	715G4798M01000004F	MAIN PCB FR-4 92*102mm*1.6mm 6	2nd SOURCE
	F12G6300001	RUBBER	
	F12G6600001	RUBBER FEET	
	F40G-22E61518A	Rating Label for E2251SWDN-e2251Swn 迪拜 Fire bird	
	F40G000361511C	Warning Label for e51 WW WH	
	F44GBF01101	EPS for e2151vw	
	F44GBF01201	EPS for e2151vw	
	F44GBG01615-3A	Carton for E2251SWDN	
	F52G1201163001	double sides adhesive tape	
	F52G1801499001	Mylar	
	F70G22C1615-4A	E2251SWDN CD MANUAL	
	F80G-L19A10-HR	Adapter 19V 1.7A 32W AOC HONOR	
E08901	F89G604A15N-HL	POWER CORD 1500MM Europe HONGLIN	
	089G604A15N-IS	POWER CORD 1500MM Europe I-SHENG	2nd SOURCE
	F89G604A15N-JR	POWER CORD 1500MM EUROPE JIANRUN	2nd SOURCE
	F95G176J-10103	FFC CABLE 10P 326MM P0.5MM KOTL	

	F95G176X-10103	FFC CABLE 10P 326MM P0.5MM WENXIN	2nd SOURCE
F09503	F95G179X30N102	FFC CABLE 30P 241MM P1.0MM WENXIN	
	F95G179J30N102	FFC CABLE 30P 241MM P1.0MM KOTL	2nd SOURCE
	KEPCAAB5	KEY BOARD	
F09501	F95G-76T--6603	FFC CABLE 6PIN 344MM 1.0MM DIY	
	F95G-76X--6603	FFC CABLE 6PIN 344MM 1.0MM WENXIN	2nd SOURCE
	F95G-76J--6603	FFC CABLE 6PIN 344MM 1.0MM KOTL	2nd SOURCE
U001	056G-669-45	IC TOUCH KEY IT7230EFN/BX QFN16 ITE	
R005,R006	061G0402000-JT	RST CHIPR MAX0R05 1/16W TZAI YUAN	
R004	061G0402101-JT	RST CHIPR 100 OHM +-5% 1/16W 0402 TZAI YUAN	
R001	061G0402103-JT	RST CHIPR 10 KOHM +-5% 1/16W 0402 TZAI YUAN	
R002,R003,R007,R008	061G0402472-JT	RST CHIPR 4.7 KOHM +-5% 1/16W 0402 TZAI YUAN	
C008	065G040210131J---Y	MLCC 0402 100pF +-5% 50V NPO YAGEO	
	065G040210131J---A	MLCC 0402 100pF -5% 50V NPO SAMSUNG	2nd SOURCE
C005,C006,C007	065G040210427Z---Y	MLCC 0402 0.1uF -20%+80% 25V Y5V YAGEO	
	065G040210427Z---T	MLCC 0402 0.1uF -20% 80% 25V Y5V TAIYO YUDEN	2nd SOURCE
C011	065G0402105A5K---A	MLCC 0402 1uF +-10% 10V X5R SAMSUNG	
	065G0402105A5K---T	MLCC 0402 1uF -10% 10V X5R TAIYO YUDEN	2nd SOURCE
C003,C004	065G040212031J---Y	MLCC 0402 12pF +-5% 50V NPO YAGEO	
	065G040212031J---A	MLCC 0402 12pF -5% 50V NPO SAMSUNG	2nd SOURCE
D001	081G15BY--2-GP	CHIP LED blue/Orange GPTD12048BOC1-A GUANGPU	
	081G15BY--2-EL	LED Blue/Orange 12-22/BHS2C-C30/2C EVERHIGHT	2nd SOURCE
ZD001,ZD002	093G-39S501--T	DIODE ZD LUDZS5.6BT1G 5.6V/0.5W SOD-323 LRC	
	093G-39S-34--T	NO-SUGGEST Diode ZD UDZSNP5.6B ROHM	2nd SOURCE
	709G4842-QS001	COMSUPTIVE ASS""Y	

E715	715G4842K01000004S	Key Board FR-4 105*11*1.2mm 16	
	715G4842K01000004F	Key Board FR-4 105*11*1.2mm 16	2nd SOURCE
	715G4842K01000004L	Key PCB FR-4 105*11*1.2mm 16	2nd SOURCE
	Q12G6600--6	FOOT	
	Q40G000161514A	CARTON LABEL(70*80)	
	Q40G0001624-4A	PALLET LABEL	
	Q41G78D1615-9A	WARRANTY CARD	
	Q45G2010M0201A	pe bag for manual	
	Q45G8801607--7	pe bag	

Free Manuals Download Website

<http://myh66.com>

<http://usermanuals.us>

<http://www.somanuals.com>

<http://www.4manuals.cc>

<http://www.manual-lib.com>

<http://www.404manual.com>

<http://www.luxmanual.com>

<http://aubethermostatmanual.com>

Golf course search by state

<http://golfingnear.com>

Email search by domain

<http://emailbydomain.com>

Auto manuals search

<http://auto.somanuals.com>

TV manuals search

<http://tv.somanuals.com>