

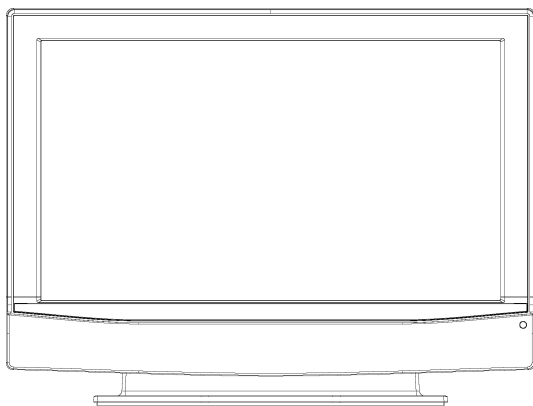

USER'S MANUAL

L26W661



ENVISION *Series*

Thank you very much for choosing the AOC Envision Series LCD TV.
We recommend that you take a few minutes to read carefully through this manual before installing and using the TV. Please keep this manual in a safe place for your future reference.

www.AOC.com

TABLE OF CONTENTS

TABLE OF CONTENTS 1

FOR YOUR SAFETY 2

PRECAUTIONS AND REMINDERS3

IMPORTANT SAFETY INSTRUCTIONS 5

PREPARATION 7

PERIPHERAL CONNECTION GUIDE 9

OPERATING INSTRUCTIONS 11

 TO USE THE FRONT PANEL CONTROL 11

 TO USE THE REMOTE CONTROL 12

 TO USE THE MENUS 13

 SETUP MENU 13

 VIDEO MENU 14

 AUDIO MENU 15

 FEATURE MENU 16

 TIPS 20



PRODUCT SPECIFICATION 22

BEFORE CALLING SERVICE 23

 GLOSSARY 24

 APPENDIX25

 MOUNTING THE TV BASE26

SYMBOL	SYMBOL DEFINITION
 SA 1965	DANGEROUS VOLTAGE: The lightning flash with arrowhead symbol, within an equilateral triangle, is intended to alert the user to the presence of uninsulated “dangerous voltage” within the product’s enclosure that may be of sufficient magnitude to constitute a risk of electrical shock to persons.
 SA 1966	INSTRUCTIONS: The exclamation point within on equilateral triangle to alert the User to the presence of important operating and maintenance (servicing) instruction In the literature accompanying the appliance.

Apparatus shall not be exposed to dripping or splashing and no objects filled with liquids, Such as vases, Shall be placed on the apparatus.
 Caution - Danger of explosion if battery is incorrectly replaced. Replace only with the same or equivalent type.

FOR YOUR SAFETY

Before operating the TV please read this manual thoroughly. This manual should be retained for future reference.

FCC Class B Radio Frequency Interference Statement

WARNING: (FOR FCC CERTIFIED MODELS)

NOTE: This equipment has been tested and found to comply with the limits for a Class B digital device, pursuant to Part 15 of the FCC Rules. These limits are designed to provide reasonable protection against harmful interference in a residential installation. This equipment generates, uses and can radiate radio frequency energy, and if not installed and used in accordance with the instructions, may cause harmful interference to radio communications. However, there is no guarantee that interference will not occur in a particular installation. If this equipment does cause harmful interference to radio or television reception, which can be determined by turning the equipment off and on, the user is encouraged to try to correct the interference by one or more of the following measures:

1. Reorient or relocate the receiving antenna.
2. Increase the separation between the equipment and receiver.
3. Connect the equipment into an outlet on a circuit different from that to which the receiver is connected.
4. Consult the dealer or an experienced radio/TV technician for help.

NOTICE

1. The changes or modifications not expressly approved by the party responsible for compliance could void the user's authority to operate the equipment.
2. Shielded interface cables and AC power cord, if any, must be used in order to comply with the emission limits.
3. The manufacturer is not responsible for any radio or TV interference caused by unauthorized modification to this equipment. It is the responsibilities of the user to correct such interference.

WARNING:

To prevent fire or shock hazard, do not expose the TV to rain or moisture. Dangerously high voltages are present inside the TV. Do not open the cabinet. Refer servicing to qualified personnel only.

SAFETY: Lamp Disposal

 LAMP(S) INSIDE THIS PRODUCT CONTAIN MERCURY AND MUST BE RECYCLED OR DISPOSED OF ACCORDING TO LOCAL, STATE OR FEDERAL LAWS. FOR MORE INFORMATION, CONTACT THE ELECTRONIC INDUSTRIES ALLIANCE AT WWW.EIAE.ORG.

PRECAUTIONS AND REMINDERS

Place unit on even surfaces.

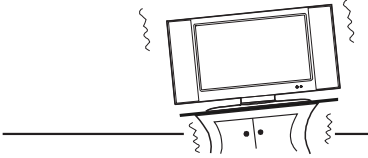

Don't place the TV in confined spaces or in a box when using it.

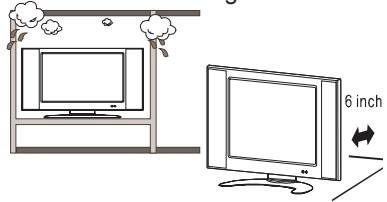

Unplug immediately if is malfunction like no picture, no video/audio, smoke and bad odor from TV.

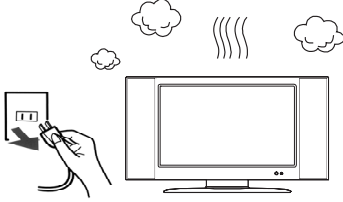

Unplug immediately if other foreign materials are put inside TV box or if the TV fell down.

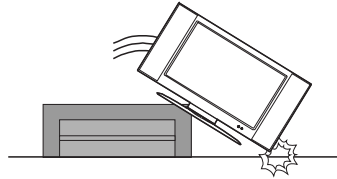

Don't throw any object inside the TV box like metals or other flammable materials.

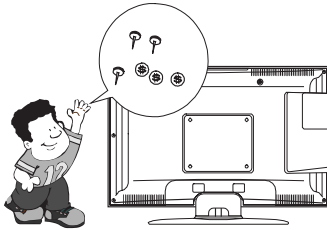

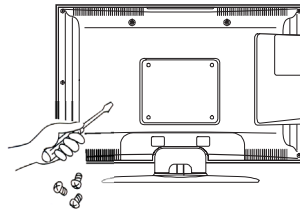

Prohibit/Avoid opening TV cabinet

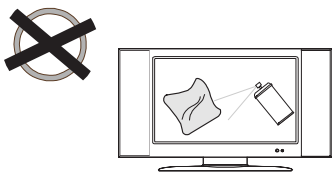
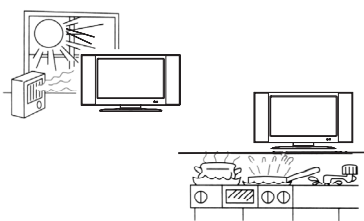
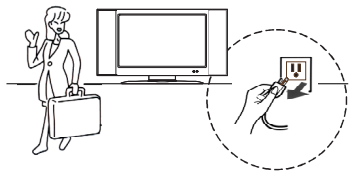
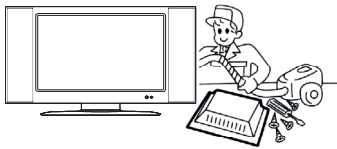
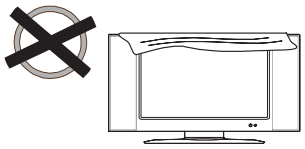
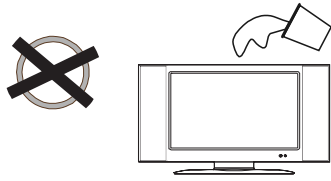

<p>Remember to unplug the AC cord from the AC outlet before cleaning. Do not use liquid cleaners or aerosol cleaners to clean the display.</p> 	<p>Avoid direct sunlight, dusty, high humidity and smoky areas.</p> 
<p>Make sure to unplug the unit when not in use for a long period of time (days).</p> 	<p>Call service personnel to clean the internal part of the TV once a year.</p> 
<p>Do not cover or block any vents and openings. Inadequate ventilation may shorten the life of the display unit and cause overheating.</p> 	<p>Do not place the display near water, such as bathtub, washbasin, kitchen sink laundry tub, swimming pool or in a damp basement.</p> 

 Notice for Remote Controller

<p>Avoid Dropping</p> 	<p>Avoid Liquids</p> 	<p>Avoid Aerosol Cleaners</p> 
-----------------------------------------------------------------------------------------------------------	----------------------------------------------------------------------------------------------------------	-------------------------------------------------------------------------------------------------------------------

IMPORTANT SAFETY INSTRUCTIONS

Read before operating equipment

1. Read these instructions.
2. Keep these instructions.
3. Heed all warnings.
4. Follow all instructions.
5. Do not use this apparatus near water.
6. Clean only with a dry cloth.
7. Do not block any of the ventilation openings. Install in accordance with the manufacturers instructions.
8. Do not install near any heat sources such as radiators, heat registers, stoves, or other apparatus (including amplifiers) that produce heat.
9. Do not defeat the safety purpose of the polarized or grounding type plug. A polarized plug has two blades with one wider than the other. A grounding type plug has two blades and third grounding prong. The wide blade or third prong is provided for your safety. When the provided plug does not fit into your outlet, consult an electrician for replacement of the obsolete outlet.
10. Protect the power cord from being walked on or pinched particularly at plugs, convenience receptacles, and the point where they exit from the apparatus.
11. Only use attachments/accessories specified by the manufacturer.
12. Use only with a cart, stand, tripod, bracket, or table specified by the manufacturer, or sold with the apparatus. When a cart is used, use caution when moving the cart/apparatus combination to avoid injury from tip-over.



13. The TV should be operated only from the type of power source indicated on the label. If you are not sure of the type of power supplied to your home, consult your dealer or local power company.
14. Unplug this apparatus during lightning storms or when unused for long periods of time.
15. Refer all servicing to qualified service personnel. Servicing is required when the apparatus has been damaged in any way, such as power-supply cord or plug is damaged, liquid has been spilled or objects have fallen into apparatus, the apparatus has been exposed to rain or moisture, does not operate normally, or has been dropped.
16. This product may contain lead or mercury. Disposal of these materials may be regulated due to environmental considerations. For disposal or recycling information, please contact your local authorities or the Electronic Industries Alliance: www.eiae.org
17. **Damage Requiring Service** – The appliance should be serviced by qualified service personnel when:
 - A. The power supply cord or the plug has been damaged; or
 - B. Objects have fallen, or liquid has been spilled into the appliance; or
 - C. The appliance has been exposed to rain; or
 - D. The appliance does not appear to operate normally or exhibits a marked change in performance; or
 - E. The appliance has been dropped, or the enclosure damaged.

18. **Tilt/Stability** – All televisions must comply with recommended international global safety standards for tilt and stability properties of its cabinets design.
- Do not compromise these design standards by applying excessive pull force to the front, or top, of the cabinet, which could ultimately overturn the product.
 - Also, do not endanger yourself, or children, by placing electronic equipment/toys on the top of the cabinet. Such items could unsuspectingly fall from the top of the set and cause product damage and/or personal injury.
19. **Wall or Ceiling Mounting** – The appliance should be mounted to a wall or ceiling only as recommended by the manufacturer.
20. **Power Lines** – An outdoor antenna should be located away from power lines.
21. **Outdoor Antenna Grounding** – If an outside antenna is connected to the receiver, be sure the antenna system is grounded so as to provide some protection against voltage surges and built up static charges. Section 810 of the National Electric Code, ANSI/NFPA No. 70-1984, provides information with respect to proper grounding of the mats and supporting structure grounding of the lead-in wire to an antenna-discharge unit, size of grounding connectors, location of antenna-discharge unit, connection to grounding electrodes and requirements for the grounding electrode. See Figure below.

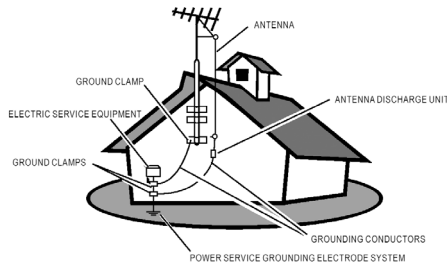

EXAMPLE OF ANTENNA GROUNDING AS PER NATIONAL ELECTRICAL CODE

Note to the CATV system installer: This reminder is provided to call the CATV system installer's attention to Article 820-40 of the NEC that provides guidelines for proper grounding and, in particular, specifies that the cable ground shall be connected to the grounding system of the building, as close to the point of cable entry as practical.

Please, make sure to connect the power plug to the wall outlet socket after connecting the TV to the adapter!

22. **Objects and Liquid Entry** – Care should be taken so that objects do not fall and liquids are not spilled into the enclosure through openings.

PREPARATION

Please, make sure to connect the power plug to the wall outlet socket after connecting the TV to the power cord!

1. **Install the base stand; place the TV on a solid surface.**

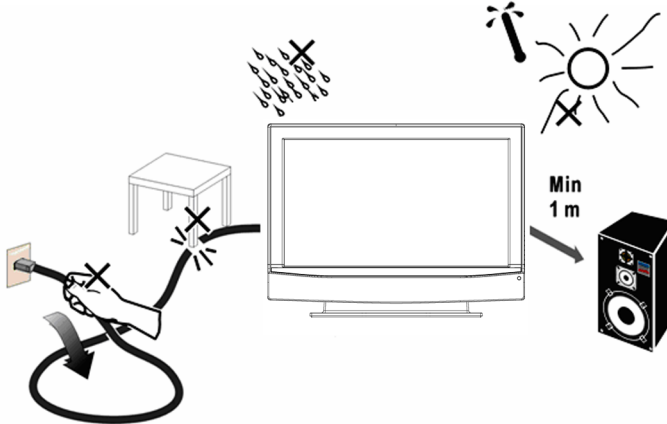

Ensure that the TV is placed in a position to allow free flow of air. Do not cover the ventilation openings on the back cover.

To prevent any unsafe situations, no naked flame sources, such as lighted candles, should be placed on or in the vicinity.

Avoid heat, direct sunlight and exposure to rain or water. The equipment shall not be exposed to dripping or splashing.

2. Connect the antenna cable or CATV cable to the aerial socket **ANT IN 75Ω** at the back of the TV set.

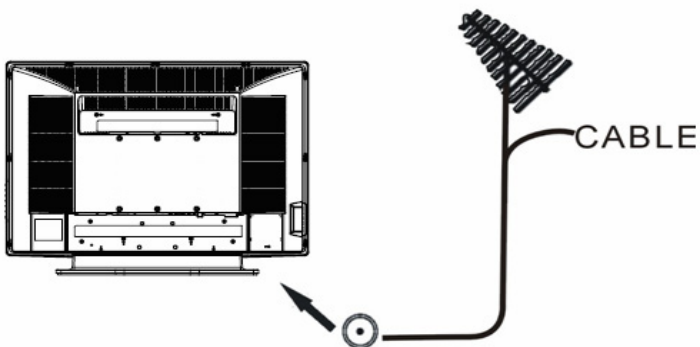

3. Remote control:

Remove the cover of the battery compartment. Insert the 2 batteries supplied (Type AA 1.5V).

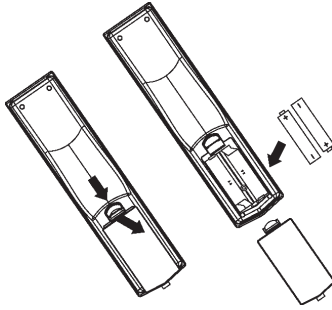
**4. Power:**

Insert the power cord in the wall socket having an AC power supply. You can see LED states at the front panel. If the LED color is Green, means the TV set is power on. If the LED color is amber, which means this TV set is in standby state.

5. Turn on the TV:

Push the POWER key on the Remote control or the control knobs on right of TV. The TV will be power-on and the user can see the display on the screen after a few seconds.

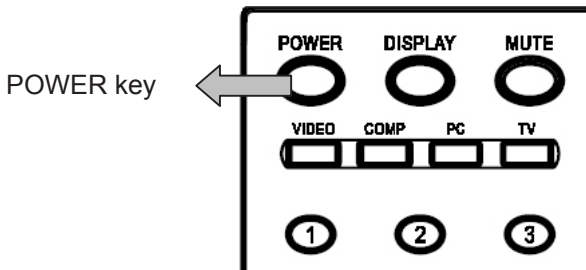

PERIPHERAL CONNECTION GUIDE

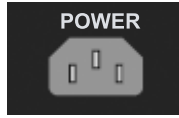

AC POWER

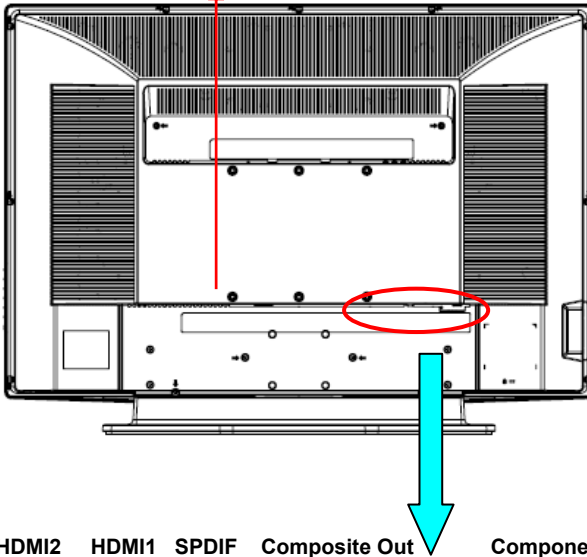

HDMI 2 **HDMI 1** **SPDIF** **Composite Out** **Component 1**
 Video L R L R Y Pb/Cb Pr/Cr

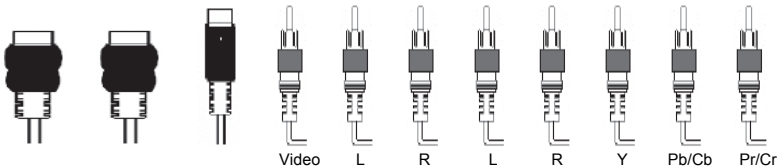
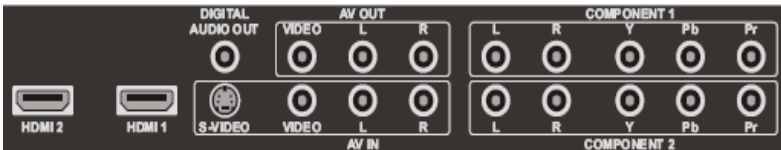

Video Rear **Composite Rear** **Component 2**

Once your equipment is connected, use the following procedure to view the input signal:

Press the source button on the remote controller to select the relevant source to view. (ex: Press VIDEO button to select "Video1 Composite Rear" if you have connected a DVD player to Video1 Composite socket.)

"HDMI, the HDMI logo and High-Definition Multimedia Interface are trademarks or registered trademarks of HDMI Licensing LLC."

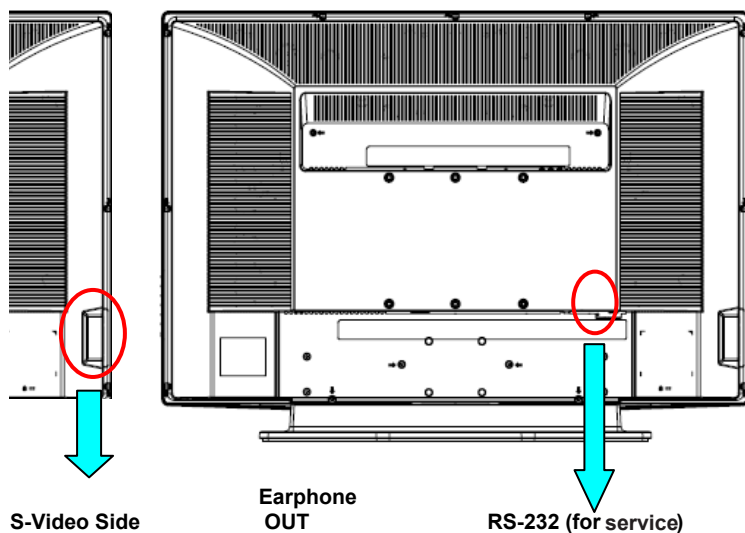

S-Video Side



Earphone
OUT

RS-232 (for service)



Composite side

Svideo

Video

L

R

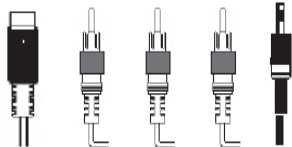

L/R Line IN Video7 VGA



PC L/R Line Output
of PC terminal

15-pin D-Sub VGA Output
of PC terminal

Note: The MUTE key on the remote control works on both TV internal speaker and the earphone output.

OPERATION INSTRUCTIONS

TO USE THE FRONT PANEL CONTROL

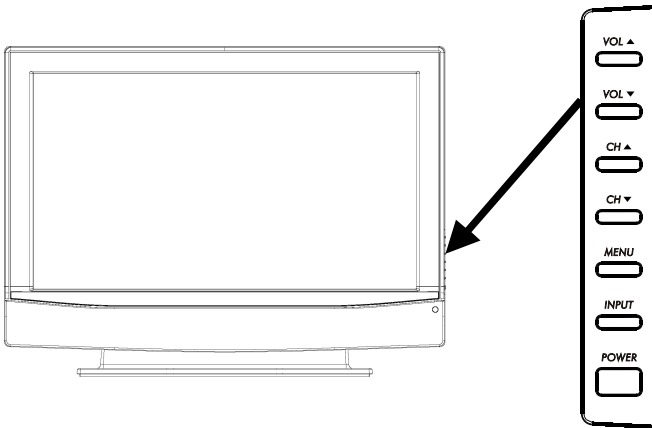

English

1	VOL+	VOL +: Press to increase the sound volume level.
2	VOL -	VOL - : Press to decrease the sound volume level.
3	CH +	CH +: Press to select the next higher Program number.
4	CH -	CH - : Press to select the next lower Program number.
5	MENU	Menu key: Press to open or exit the OSD menu.
6	INPUT	Input key: Press to select the input source.
7	POWER	Power key: Press to turn on / off (standby) the TV set. (Please re-turn on TV after the Power-ON status LED had changed to the orange color and finished flashing.)

TO USE THE REMOTE CONTROL

“POWER”

Press to power ON/OFF (standby) TV.
(Note:1.TV is never completely power off unless physically unplugged.

- 2.Press to turn on TV after the power on status LED had changed to the amber color and stopped flashing.)

“VIDEO”

Press repeatedly to choose S-Video/ Composite source mode (Video 1 ~ 4).

“COMP”

Press repeatedly to choose Component source mode (Video 5 ~ 6).

“PC”

Press repeatedly to choose VGA or HDMI source mode (Video 7 ~ 9).

“TV”

Press to choose ATSC/NTSC TV source mode.

“0 ~ 9 /- number”

Press to enter TV channel number to select channel (Press ‘.’ to indicate choosing the sub-channel).

“SLEEP”

Press to set a time period (off/30min/ 60min/90min) after which the TV should switch itself to standby mode.

“FREEZE”

Press to freeze the displayed picture

“VOL- / VOL+”

Press + or - to adjust the volume.

“MENU”

Press to open or exit menu.

“▲” “▼” “◀” “▶” “OK”

Press to adjust the various function items on the menu.

“V-CHIP”

Press to lock / unlock Parental Control temporarily. (After setting the restricted table of MPAA or TV Rating.)

“DISPLAY”

Press to show the information about the input source \ TV channel \ display resolution and current time.

“MUTE”

Press to set TV sound mute ON/OFF.

“PREV CH”

Press to display the previous TV.

“MTS/SAP”

Press to activate the NTSC TV sounds, such as: Stereo, SAP or Mono tone.

“WIDE”

Press to choose the display aspect as: Normal, Wide, Zoom or Cinema mode.

“SOURCE”

Press repeatedly to choose the various input sources (Video 1 ~ 9).

“CH- / CH +”

Press + or - to browse through the TV channels.

“Exit”

Press to exit menu or OSD.

“VIDEO ADJ”

Press to choose the Brightness or Contrast adjustment.

“AUDIO ADJ”

Press to switch the ATSC multi-channel TV sounds.

“CC”

Press repeatedly to change cc on/cc off/cc on when mute

“EPG”

Press to show the information the same as “DISPLAY” key.

“FAV”

Press to turn on/off favorite mode (use CH up and down to change after setting the favorite TV channel on main menu)

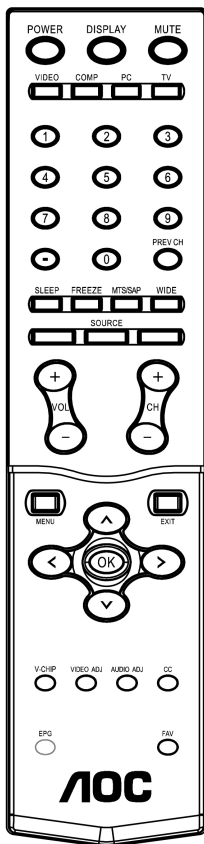

TO USE THE MENU

1. Press the **MENU** button to display the main menu
2. Use the **cursor up/down** to select a menu item.
3. Use the **cursor left/right** to enter a submenu.
4. Press the **OK** button to enable/disable the function.
5. Press the **MENU** or **EXIT** button to exit the menu.

Press the MENU button to enter the main OSD (On Screen Display). Adjust the items including **Setup menu**, **Video menu**, **Audio menu** and **Feature menu**. However, some function items in the menus may only be enabled in the particular source modes.

SETUP MENU

The Setup menu in TV mode shows as below. In others source modes, the Setup menu only shows **Menu Language** and **Aspect Ratio** items.

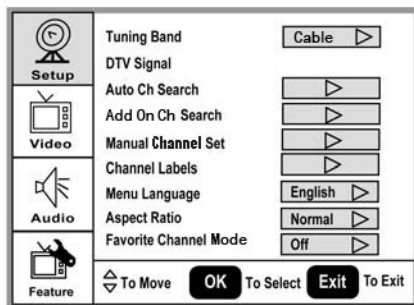

1. **Tuning Band**: Select TV source signal from the Air (antenna) or Cable (CATV).
2. **DTV Signal**: Show the intensity of the received DTV signal.

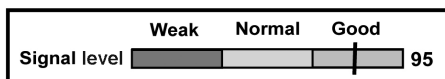

3. **Auto Ch Search**: Automatically scan all NTSC / ATSC TV channels and then store in the channel table. In channel scan process, the OSD can display the number of channels which had been found.

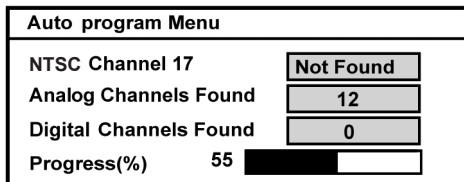

4. **Add on Ch search:** Add channels which are new found.
5. **Manual Channel Set:** Show the channel setup table. User can choose to display the ATSC or NTSC TV channels and then edit (add/delete) the channel numbers.
6. **Channel Labels:** Show the NTSC or ATSC TV channel label menu for user modifying channel labels specifically.
7. **Menu Language:** Select the menu display language. (English /Spanish / French)
8. **Aspect Ratio:** Select the display aspect ratio. (Normal / Zoom / Wide / Cinema)
9. **Favorite Channel Mode:** when favorite channel mode on user can edit favorite channel table in favorite channel set option.

VIDEO MENU

The Video menu in most source modes shows as below. It provides several video adjustment items for user fine tuning the video display. Only in VGA source modes, the Video menu simply provides **Contrast**, **Brightness**, **Back light** and **Settings (Preset)** items.

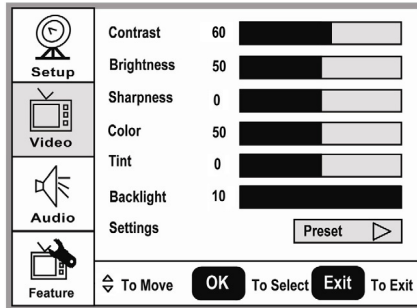

1. **Contrast:** Video contrast adjustment, the tuning range is 0 ~ 100.
2. **Brightness:** Video brightness adjustment, the tuning range is 0 ~ 100.
3. **Sharpness:** Video sharpness adjustment, the tuning range is -50 ~ 50.
4. **Color:** Video color chroma adjustment, the tuning range is 0 ~ 100.
5. **Tint:** Video tint adjustment, the tuning range is R50 ~ G50.
6. **BackLight:** Back light strength adjustment, the tuning range is 0 ~ 10.
7. **Settings:** Restore the default video settings.

AUDIO MENU

The Audio menu in TV mode shows as below. It provides audio adjustment for user to modify the audio setting. Except in ATSC TV mode, some audio adjustment items for user to modify the audio setting. Excepting in ATSC TV mode, the **Audio Language** option is disable in others source modes. The audio language setting is only available in ATSC TV source. Furthermore, the **Bass** and **Treble** tuning items are only enabled while the **SRS** option set "Off" (tune-off the SRS sound effect). The Default states of **Bass** and **Treble** items are enabled as well as **SRS** option set "Off".

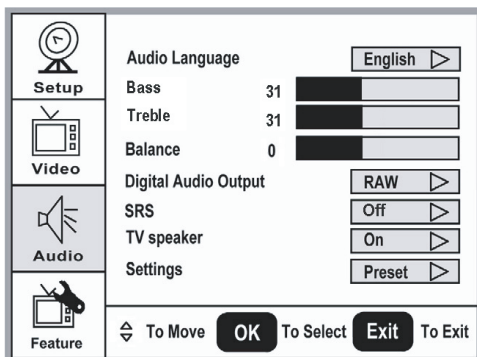

- 1. Audio Language:** Change the audio language setting on ATSC TV programs. The number of the supported audio languages depends on the ATSC TV programs.
- 2. Bass:** Bass tone adjustment, the tuning range is 0 ~ 63. (The default state is enabled)
- 3. Treble:** Treble tone adjustment, the tuning range is 0 ~ 63. (The default state is enabled)
- 4. Balance:** Audio balance adjustment, the tuning range is L31 ~ R31.
- 5. Digital Audio Output:** Digital audio output format selection, user can choose RAW (default) or PCM format.
- 6. SRS:** Choose to turn on / off the SRS sound effect. The default value is Off.
- 7. TV Speaker:** Choose to turn on / off the TV internal speaker. The digital audio output signals, earphone output signals and the composite L/R audio output signals will not be turn-off even though the TV speaker is off. The default setting is On.
- 8. Settings:** Restore the default audio settings.

SRS, SRS and  are registered trademarks of SRS Labs, Inc. This product is designed using SRS technology with permission from SRS Labs, Inc.

FEATURE MENU

The Feature menu in TV mode shows as below. It provides certain optional control functions such as time set, sleep timer, video noise reduction, parental control (V-chip) and close caption style setting. This menu gives users the most flexibilities to satisfy their generally demands. According to the various requirements in different source modes, certain features should be hidden (disable) on the menu. The details footnotes will be described clearly below.

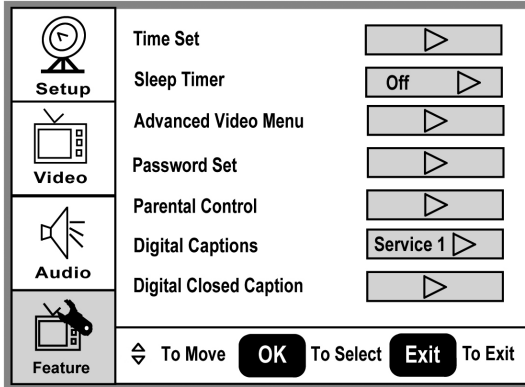

1. **Time Set:** Set current time. This sub-menu includes **Time Zone** and **Time** items. 【Time Zone】 item provides user to set current time zone, such as: Pacific、Alaska、Hawaii、Eastern、Central and Mountain. 【Time】 item provides user to set the time clock.

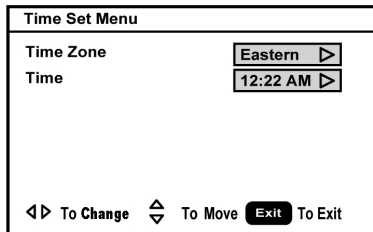

2. **Sleep Timer:** Enable or disable the TV standby timer. User can set the TV standby timer as **off / 5 min / 10 min / 15 min / 30 min / 45 min / 60 min / 90 min / 120 min / 180 min / 240 min**. Timer starts to count down after cursor leaving the sub-menu. (At the moment, the item shows 『** min Left』 and the cursor highlights on the Feature icon.)
3. **Advanced Video Menu:** Provide the **Noise Reduction** setting、**Color Temperature** and **3D Y/C filter** options for enhancing video quality.

【Noise Reduction】 gives four NR effect degrees, such as: Low · Mid · High and Off.

The default setting is off .

【3D Y/C】 provides On / Off switches. The default setting is On.

【Color Temp】 gives three color temperature modes as: Normal · Warm and Cool. The default mode is Warm. o

【Setting】 restores the default advanced video option settings.

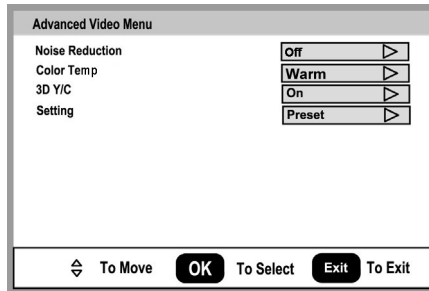

4. **Password Set:** Change the 4-numeral parental control password. Three steps are required for changing the password: *Enter Old Password* -> *Enter New Password* -> *Confirm New Password*. Note: This item is only available in TV, Composite and S-Video source modes. The default password is 『0000』 .

Enter Old Password
<input type="text"/> <input type="text"/> <input type="text"/> <input type="text"/>

Enter New Password
<input type="text"/> <input type="text"/> <input type="text"/> <input type="text"/>

Confirm New Password
<input type="text"/> <input type="text"/> <input type="text"/> <input type="text"/>

5. **Parental Control:** provide the parental Control (V-chip) function setting. Before entering the Parental Control sub-menu, user has to key in the password first. Then enter the *Parental Lock* item, User can modify the restricted table about MPAA or TV Rating respectively. While exiting the sub-menu, the parental control function is working. The inhibitive channels or source signals can be un-lock through pressing the V-CHIP key on the remote control and then key in the correct password. Note: This feature is only available in TV, Composite and S-Video source modes. (The default password is: 0000.)

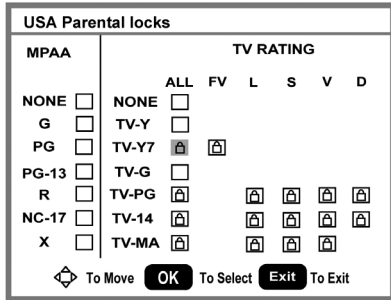
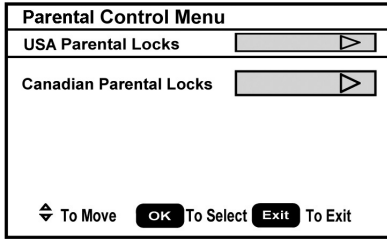
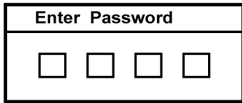

6. **Digital Captions:** Select the close caption options (Service 1-6, Text 1-4 and CC 1-4) in digital TV mode. When select service 1 to service 6 you can modulate parameters in the Digital Close Caption.

7. **Digital Closed Caption:** Provide numerous options for setting the close caption style. In the sub-menu.

【Style】 item can be set as Automatic or Custom mode.

If Custom mode is selected, user can modify the detail styles described below.

The setting result will be shown immediately on the bottom side of the sub-menu OSD.

Note: This feature is only available in Digital TV (ATSC) mode.

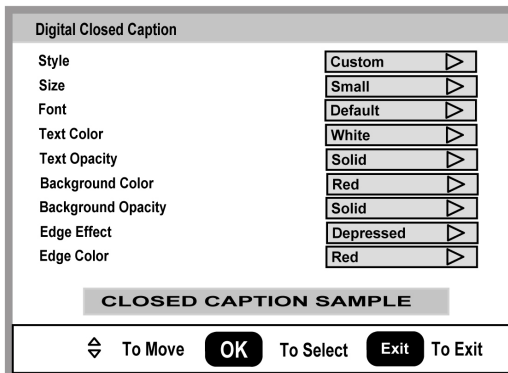

- 【Size】 : Digital close caption font size, which can be set as Small · Normal or Large.
 - 【Font】 : Digital close caption font style, which can be chosen as Default or Font 1 ~ 7.
 - 【Text Color】 : Giving Red / Green / Blue / Yellow / Magenta / Cyan / Black / White Colors.
 - 【Text Opacity】 : Giving Transparent / Translucent / Solid / Flashing modes.
 - 【Background Color】 : Giving Red / Green / Blue / Yellow / Magenta / Cyan / Black / White Colors.
 - 【Background Opacity】 : Giving Transparent / Translucent / Solid / Flashing modes.
 - 【Edge Effect】 : The text edge effects, which gives None / Raised / Depressed / Uniform / Left Shadow / Right Shadow modes.
 - 【Edge Color】 : The colors of text edge effects, which provides Red / Green / Blue / Yellow / Magenta / Cyan / Black / White Colors.
8. **Component Set:** This option only shows and is available in component mode, which provides fine tuning component display, such as: 【H-Position】、【V-Position】 and 【Phase】. All these items are giving the tuning range from 0 to 100. 【Setting】 item provides the default component setting values restoring.

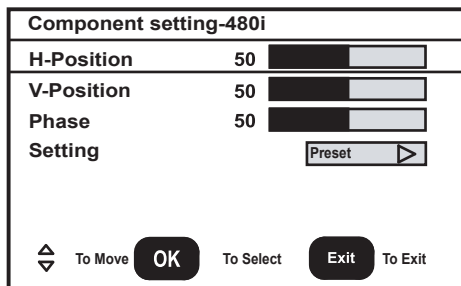

9. **VGA Set:** This option only shows and is available in VGA mode, which provides fine tuning VGA display, such as : 【H-Position】、【V-Position】、【Clock】 and 【Phase】. All these items are giving the tuning range from 0 to 100. 【Setting】 item provides the default VGA setting values restoring.

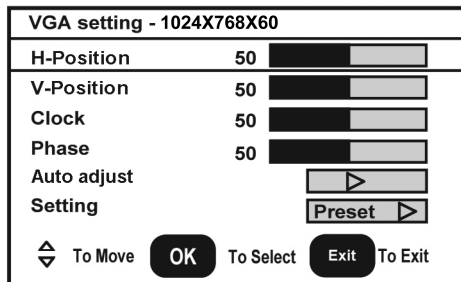

TIPS

Care of the screen

Do not rub or strike the screen with anything hard as this may scratch, mar, or damage the screen permanently.

Unplug the power cord before cleaning the screen. Dust the TV by wiping the screen and the cabinet with a soft, clean cloth. If the screen requires additional cleaning, use a clean, damp cloth. Do not use liquid cleaners or aerosol cleaners.

Mobile telephone warning

To avoid disturbances in picture and sound, malfunctioning of your TV or even damage to the TV, keep away your mobile telephone from the TV.

End of life directives

We are paying a lot of attention to produce environmentally friendly in green focal areas. Your new receiver contains materials, which can be recycled and reused.

At the end of its life specialized companies can dismantle the discarded receiver to concentrate the reusable materials and to minimize the amount of materials to be disposed of.

Please ensure you dispose of your old receiver according to local regulations.

Regulatory Notices – Federal Communications Commission Notice

This equipment has been tested and found to comply with the limits for a Class B digital device, pursuant to part 15 of the FCC Rules. These limits are designed to provide reasonable protection against harmful interference in a residential installation. This equipment generates, uses, and can radiate radio frequency energy and, if not installed and used in accordance with the instructions, may cause harmful interference to radio communications. However, there is no guarantee that interference will not occur in a particular installation. If this equipment does cause harmful interference to radio or television reception, which can be determined by turning the equipment off and on, the user is encouraged to try to correct the interference by one or more of the following measures:

- Reorient or relocate the receiving antenna.
- Increase the separation between the equipment and the TV.
- Connect the equipment into wall power outlet on a circuit different from that to which the receiver is connected.
- Consult the dealer or an experienced radio or television technician for help.

Modifications –

The FCC requires the user to be notified that any changes or modifications made to this device that are not expressly approved by Our company. may void the user's authority to operate the equipment.

Cables –

Connections to this device must be made with shielded cables with metallic RF/EMI connector hoods to maintain compliance with FCC Rules and Regulations.

Canadian notice –

This Class B digital apparatus meets all requirements of the Canadian Interference-Causing Equipment Regulations.

Avis Canadian –

Cet appareil numérique de la classe B respecte toutes les exigences du règlement sur le matériel brouilleur du Canada.

PRODUCT SPECIFICATION

NOTE:

*This model complies with the specifications listed below.

*Designs and specifications are subject to change without notice.

*This model may not be compatible with features and/or specifications that may be added in the future.

Television System:

NTSC standard
ATSC standard (8-VSB, Clear-QAM)

Viewable image size:

660mm diagonal

Channel Coverage:

VHF: 2 through 13
UHF: 14 through 69
Cable TV: Mild band (A-8 through A-1, A through I)

Super band (J through W)
Hyper band (AA through ZZ, AAA, BBB)
Ultra band (65 through 94, 100 through 125)

Power Source:

AC power supply: 100V~240 V, 50/60 Hz

Power Consumption

26" : ≤ 180 W

1 W in standby mode (power cord plugged in and power OFF)

Audio Power

10 W + 10 W, Internal Speaker

Video/Audio Terminals:

Side AV include 1 Group:
S-Video/Video/Audio Input
Rear AV include 1 Group:
S-Video/Video/Audio Input

S-VIDEO INPUT:

Y : 1 V(p-p), 75 ohm, negative sync.
C : 0.286 V(p-p) (burst signal), 75 ohm

VIDEO/AUDIO INPUT:

VIDEO: 1 V(p-p), 75 ohm, negative sync.
AUDIO: 150 mV(rms)

Component INPUT:

Rear Component include 2 Groups:
Y : 1V(p-p), 75 ohm, including sync.
Pr/Cr: ±0.35V(p-p), 75 ohm
Pb/Cb: ±0.35V(p-p), 75 ohm
AUDIO: 150 mV(rms)
Suggested resolutions: 1080i, 720p, 480p, 480i

HDMI Terminals:

HDMI INPUT: Rear HDMI include 2 HDMI Input
HDCP compliant
E-EDID compliant
Suggested scan rates: 1080i, 720p, 480p, 480i

VGA Terminals:

VGA INPUT:
Rear VGA include 1 D-SUB 15 Pin Input
E-EDID compliant
Suggested scan rates: 640X480 /60Hz
800x600 /60Hz
1024X768 /60Hz
1360X768 /60Hz
Audio INPUT: Headphone Mini-jack for stereo (3.5Φ)

Video/Audio Output:

VIDEO: 1 V(p-p), 75 ohm, negative sync
AUDIO: 150 mV(rms)

Dimensions:

Include Stand:
26": 674.9 mm(W) x 532.1 mm(H) x 220.73mm(L)

Weight: 26": 11 kg

Wall Mounting: Optional

VESA 26": 200 X 200 mm

Supplied Accessories:

1pcs Power cord
1pcs Remote control
(with two AA alkaline batteries)
1pcs User manual
1pcs Signal cable
1pcs Pc Audio cable

BEFORE CALLING SERVICE

Please make these simple checks before calling service. These tips may save you time and money since charges for receiver installation and adjustments of customer controls are not covered under your warranty.

Symptoms	Items to Check and Actions to follow
"Ghost " or double image	*This may be caused by obstruction to the antenna due to high rise buildings or hills. Using a highly directional antenna may improve the picture.
No power	*Check that the TV's AC power cord is plugged into the mains socket. *Unplug the TV, wait for 60 seconds. Then re-insert plug into the mains socket and turn on the TV again.
No picture	*Check antenna connection at the rear of the TV to see if it is properly connected to the TV. *Possible broadcast station trouble. Try another channel. *Adjust the contrast and brightness settings. *Check the Closed Captions setting. Some TEXT modes could block the screen,
Good picture but no sound	*Increase the VOLUME. *Check that the TV is not muted; press the MUTE button on the remote control.
Good sound but poor color	*Adjust the contrast, color and brightness settings.
Poor picture	*Sometimes, poor picture quality occurs when having activated an S-VHS camera or camcorder connected and having connected another peripheral at the same time. In this case switch off one of the other peripherals
Snowy picture and noise	*Check the antenna connection
Horizontal dotted line	*This may be caused by electrical interference (e.g. hairdryer, nearby neon lights, etc.) *Turn off the equipment.
Television not responding to remote control	*Check whether the batteries are working. Replace if necessary *Clean the remote control sensor lens on the TV. *You can still use the buttons at the front of your TV. *Select the TV mode to be sure your remote control is in the TV mode.

GLOSSARY

Audio / Video Inputs

Located on the rear and the front of the receiver these connectors (RCA phono type plug) are used for the input of audio and video signals. Designed for use with VCRs (or other accessories) in order to receive higher picture resolution and offer sound connection options.

Menu

An on-screen listing of features shown on the TV screen is made available for user adjustments.

MPAA

Motion Picture Association of America

Multichannel Television sound (MTS)

The broadcasting standard, which allows stereo sounds to be transmitted with the TV picture.

Programming

The procedure of adding or deleting channel numbers into the TV's memory. In this way the TV remembers only the locally available or desired channel numbers and skips over any unwanted channel numbers.

RF

Radio Frequency or modulated signal design used as the carrier for television broadcasts.

Second Audio Program (SAP)

Another or additional audio channel provided for in the Multichannel Television Sound (MTS) broadcast standard. A monaural soundtrack included within the recorded or video signal (usually containing a second language translation for the displayed program).

Sleep Timer

You can set a time period for which the TV will automatically turn itself off.

S-Video Input

You can connect your TV set to a high-resolution video source (such as Super VHS video-cassette recorder, Laser Disc player and DVD Home Theater Set) in order to provide maximum consumer viewing satisfaction.

APPENDIX

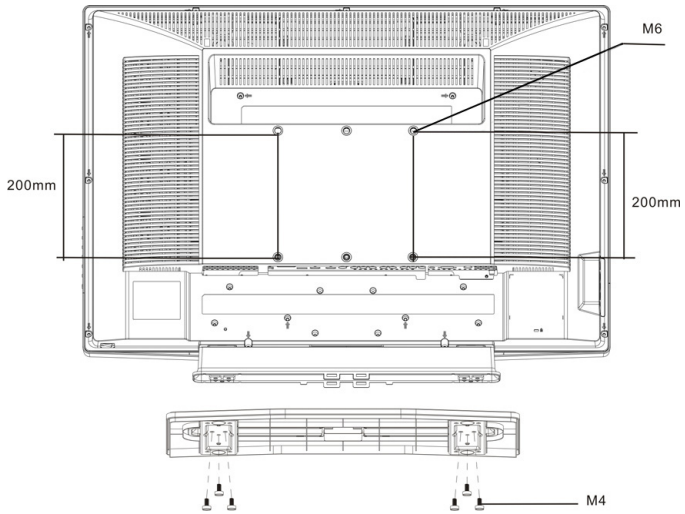

English

Use of Wall Mount Bracket

1. Remove the M4 screws from the base.
2. Fasten M6 screws to secure the wall mount bracket.

MOUNTING THE TV BASE

The TV base will be separated with the TV unit. You should install the base before you use the TV unit.

1. Place the TV on its face on a soft blanket.
2. Install the base stand with three screws.
3. Place the TV on the table.

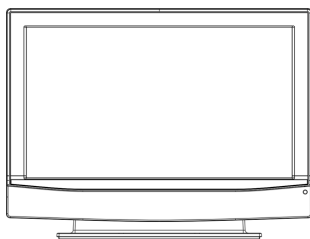
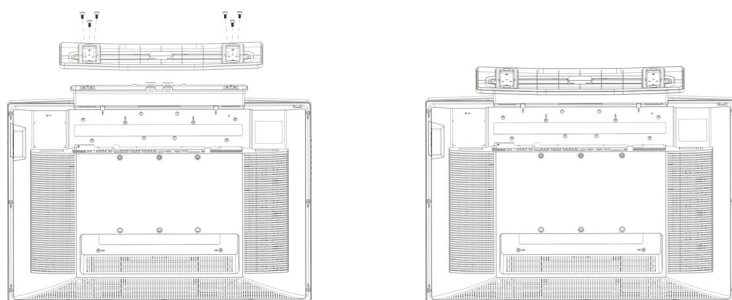

Free Manuals Download Website

<http://myh66.com>

<http://usermanuals.us>

<http://www.somanuals.com>

<http://www.4manuals.cc>

<http://www.manual-lib.com>

<http://www.404manual.com>

<http://www.luxmanual.com>

<http://aubethermostatmanual.com>

Golf course search by state

<http://golfingnear.com>

Email search by domain

<http://emailbydomain.com>

Auto manuals search

<http://auto.somanuals.com>

TV manuals search

<http://tv.somanuals.com>