

User's Manual

22" LCD TV

L22H998

ENVISION *Series*



AOC

HDTV



Content

FOR YOUR SAFETY	2
PRECAUTIONS AND REMINDERS	4
IMPORTANT SAFETY INSTRUCTIONS	6
Quick Installation	8
Wall-mount instruction	9
ACCESSORIES	11
FRONT PANEL BUTTONS	12
BACK PANEL BUTTONS.....	13
REMOTE CONTROL	14
INSTALLATION.....	16
Connecting RF antenna and Cable TV	16
Connecting to DVD / Set Top Box.....	16
Connecting to the Headphone	18
Connecting to a Computer	18
Connecting with the power cord	19
BASIC OPERATION	20
Turning on the LCD TV	20
Power On/Off	20
Select input source	20
Volume Adjusting	20
INFO	20
Electronic Program Guide (EPG).....	21
Channel Select	21
List.....	21
Favorite Channels.....	22
Sleep Time Setting.....	22
Zoom	22
MTS Selecting	22
C.C Mode	22
Using the OSD function	23
ADVANCED OPERATION—OSD MENU	24
PICTURE Menu.....	24
AUDIO Menu	25
TIME Menu	26
OPTION Menu.....	27
LOCK Menu.....	29
CHANNEL Menu.....	33
TECHNICAL SPECIFICATION	36
SAFETY PRECAUTIONS	37
CARE AND MAINTENANCE	38
TROUBLESHOOTING.....	38

 SA 1965	DANGEROUS VOLTAGE: The lightning flash with arrowhead symbol, within an equilateral triangle, is intended to alert the user to the presence of uninsulated "dangerous voltage" within the product's enclosure that may be of sufficient magnitude to constitute a risk of electrical shock to persons.
 SA 1966	INSTRUCTIONS: The exclamation point within an equilateral triangle to alert the User to the presence of important operating and maintenance (servicing) instructions in the literature accompanying the appliance.

Apparatus shall not be exposed to dripping or splashing and no objects filled with liquids, Such as vases, Shall be placed on the apparatus.

Caution - Danger of explosion if battery is incorrectly replaced. Replace only with the same or equivalent type.

FOR YOUR SAFETY

Before operating the TV please read this manual thoroughly. This manual should be retained for future reference.

FCC Class B Radio Frequency Interference Statement

WARNING: (FOR FCC CERTIFIED MODELS)

NOTE: This equipment has been tested and found to comply with the limits for a Class B digital device, pursuant to Part 15 of the FCC Rules. These limits are designed to provide reasonable protection against harmful interference in a residential installation. This equipment generates, uses and can radiate radio frequency energy, and if not installed and used in accordance with the instructions, may cause harmful interference to radio communications. However, there is no guarantee that interference will not occur in a particular installation. If this equipment does cause harmful interference to radio or television reception, which can be determined by turning the equipment off and on, the user is encouraged to try to correct the interference by one or more of the following measures:

1. Reorient or relocate the receiving antenna.
2. Increase the separation between the equipment and receiver.
3. Connect the equipment into an outlet on a circuit different from that to which the receiver is connected.
4. Consult the dealer or an experienced radio/TV technician for help.

NOTICE

1. The changes or modifications not expressly approved by the party responsible for compliance could void the user's authority to operate the equipment.
2. Shielded interface cables and AC power cord, if any, must be used in order to comply with the emission limits.
3. The manufacturer is not responsible for any radio or TV interference caused by unauthorized modification to this equipment. It is the responsibilities of the user to correct such interference.

WARNING:

To prevent fire or shock hazard, do not expose the TV to rain or moisture. Dangerously high voltages are present inside the TV. Do not open the cabinet. Refer servicing to qualified personnel only.

SAFETY: Lamp Disposal

 LAMP(S) INSIDE THIS PRODUCT CONTAIN MERCURY AND MUST BE RECYCLED OR DISPOSED OF ACCORDING TO LOCAL, STATE OR FEDERAL LAWS. FOR MORE INFORMATION, CONTACT THE ELECTRONIC INDUSTRIES ALLIANCE AT WWW.EIAE.ORG.

DIGITAL TELEVISION TRANSITION NOTICE

This device contains a digital television tuner, so it should receive digital over the air TV programming, with a suitable antenna, after the end of full-power analog TV broadcasting in the United States on June 12, 2009. Some older television receivers, if they rely on a TV antenna, will need a TV Converter to receive over the air digital programming, but should continue to work as before for other purposes (e.g., for watching low-power TV stations still broadcasting in analog, watching pre-recorded movies, or playing video games).

For more information,
call the FCC at 1-888-CALL-FCC (1-888-225-5322)
or see www.DTV.gov. For information on the TV Converter program, and on
government coupons that may be used toward the purchase
of one, see www.dtv2009.gov,
or call the NTIA at 1-888-DTV-2009.

AVISO RELATIVO A LA TRANSICIÓN A TELEVISIÓN DIGITAL

Este equipo incorpora un sintonizador de televisión digital, lo que le permitirá recibir una programación digital televisada por aire, con una antena adecuada, cuando se terminará la transmisión de alta potencia de la televisión analógica en los Estados Unidos el 12 de Junio de 2009. Ciertos receptores de televisión antiguos, si dependen de una antena de TV, necesitarán un conversor de TV para recibir por el aire una programación digital, pero seguirán funcionando como antes para otros usos (por ejemplo para ver emisoras de TV de baja potencia que todavía transmiten en analógico, para ver películas pregrabadas, o para utilizar sus videojuegos).

Para obtener más información,
llame FCC 1-888-CALL-FCC (1-888-225-5322)
o refiérase a www.DTV.gov. Para toda información sobre el programa de
conversores de TV, y acerca de los cupones del gobierno que se pueden usar
para comprarlos, refiérase a www.dtv2009.gov,
o llame al NTIA al 1-888-DTV-2009.

PRECAUTIONS AND REMINDERS

Place unit on even surfaces.

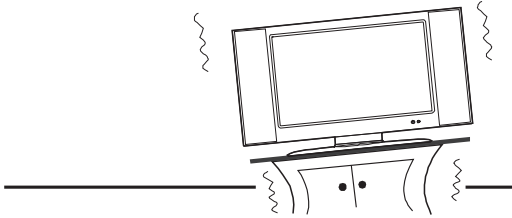

Don't place the TV in confined spaces or in a box when using it.

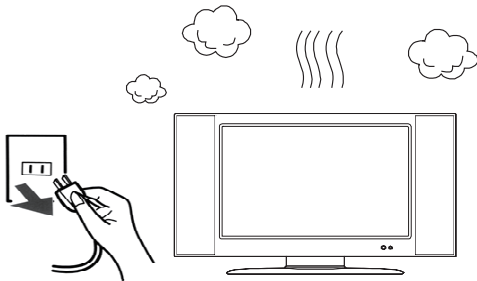
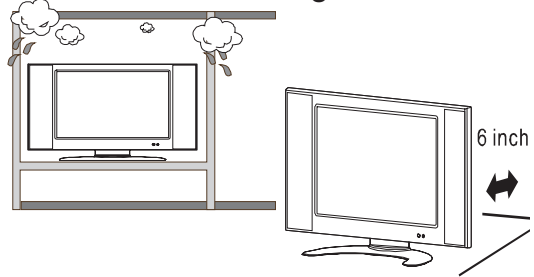

Unplug immediately if is malfunction like no picture, no video/audio, smoke and bad odor from TV.

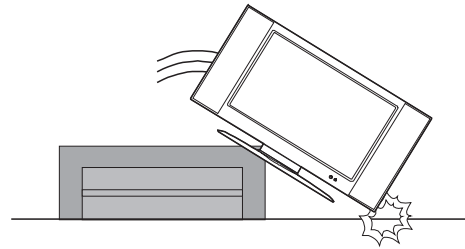

Unplug immediately if other foreign materials are put inside TV box or if the TV fell down.

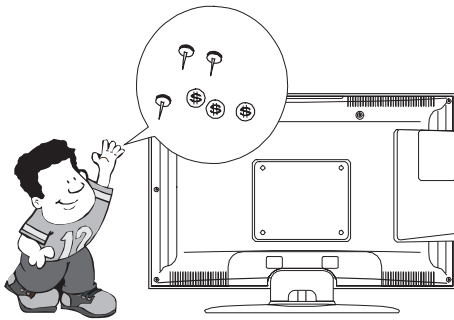

Don't throw any object inside the TV box like metals or other flammable materials.

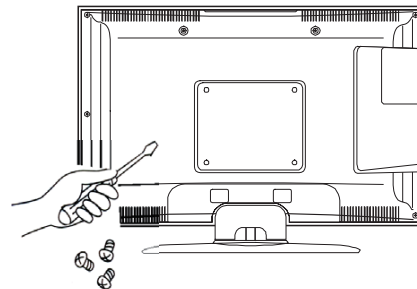

Prohibit/Avoid opening TV cabinet

Remember to unplug the AC cord from the AC outlet before cleaning. Do not use liquid cleaners or aerosol cleaners to clean the display.

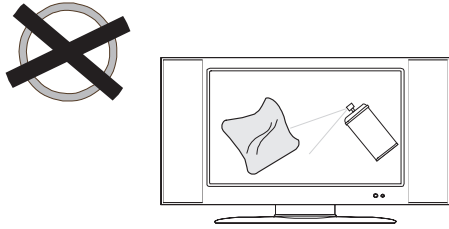

Avoid direct sunlight, dusty, high humidity and smoky areas.

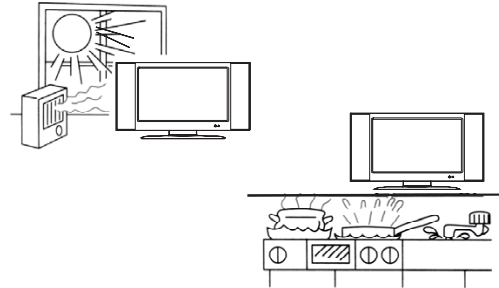

Make sure to unplug the unit when not in use for a long period of time (days).

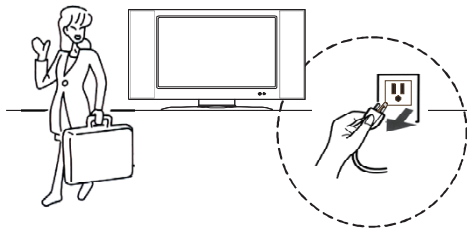

Call service personnel to clean the internal part of the TV once a year.

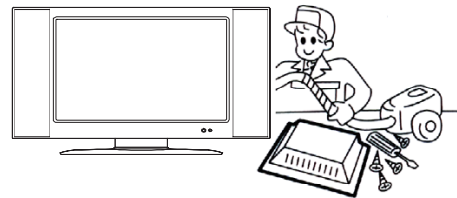

Do not cover or block any vents and openings. Inadequate ventilation may shorten the life of the display unit and cause overheating.

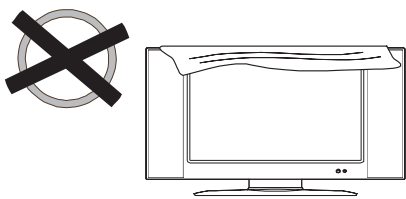

Do not place the display near water, such as bathtub, washbasin, kitchen sink laundry tub, swimming pool or in a damp basement.

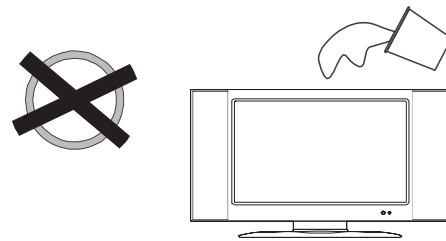

Notice for Remote Controller

Avoid Dropping



Avoid Liquids



Avoid Aerosol Cleaners



IMPORTANT SAFETY INSTRUCTIONS

Read before operating equipment

1. Read these instructions.
2. Keep these instructions.
3. Heed all warnings.
4. Follow all instructions.
5. Do not use this apparatus near water.
6. Clean only with a dry cloth.
7. Do not block any of the ventilation openings. Install in accordance with the manufacturers instructions.
8. Do not install near any heat sources such as radiators, heat registers, stoves, or other apparatus (including amplifiers) that produce heat.
9. Do not defeat the safety purpose of the polarized or grounding type plug. A polarized plug has two blades with one wider than the other. A grounding type plug has two blades and third grounding prong. The wide blade or third prong is provided for your safety. When the provided plug does not fit into your outlet, consult an electrician for replacement of the obsolete outlet.
10. Protect the power cord from being walked on or pinched particularly at plugs, convenience receptacles, and the point where they exit from the apparatus.
11. Only use attachments/accessories specified by the manufacturer.
12. Use only with a cart, stand, tripod, bracket, or table specified by the manufacturer, or sold with the apparatus. When a cart is used, use caution when moving the cart/apparatus combination to avoid injury from tip-over.



13. The TV should be operated only from the type of power source indicated on the label. If you are not sure of the type of power supplied to your home, consult your dealer or local power company.
14. Unplug this apparatus during lightning storms or when unused for long periods of time.
15. Refer all servicing to qualified service personnel. Servicing is required when the apparatus has been damaged in any way, such as power-supply cord or plug is damaged, liquid has been spilled or objects have fallen into apparatus, the apparatus has been exposed to rain or moisture, does not operate normally, or has been dropped.
16. This product may contain lead or mercury. Disposal of these materials may be regulated due to environmental considerations. For disposal or recycling information, please contact your local authorities or the Electronic Industries Alliance: www.eiae.org
17. **Damage Requiring Service** – The appliance should be serviced by qualified service personnel when:
 - A. The power supply cord or the plug has been damaged; or
 - B. Objects have fallen, or liquid has been spilled into the appliance; or
 - C. The appliance has been exposed to rain; or
 - D. The appliance does not appear to operate normally or exhibits a marked change in performance; or
 - E. The appliance has been dropped, or the enclosure damaged.

18. **Tilt/Stability** – All televisions must comply with recommended international global safety standards for tilt and stability properties of its cabinets design.
 - Do not compromise these design standards by applying excessive pull force to the front, or top, of the cabinet, which could ultimately overturn the product.
 - Also, do not endanger yourself, or children, by placing electronic equipment/toys on the top of the cabinet. Such items could unsuspectingly fall from the top of the set and cause product damage and/or personal injury.
19. **Wall or Ceiling Mounting** – The appliance should be mounted to a wall or ceiling only as recommended by the manufacturer.
20. **Power Lines** – An outdoor antenna should be located away from power lines.
21. **Outdoor Antenna Grounding** – If an outside antenna is connected to the receiver, be sure the antenna system is grounded so as to provide some protection against voltage surges and built up static charges.

Section 810 of the National Electric Code, ANSI/NFPA No. 70-1984, provides information with respect to proper grounding of the mats and supporting structure grounding of the lead-in wire to an antenna-discharge unit, size of grounding connectors, location of antenna-discharge unit, connection to grounding electrodes and requirements for the grounding electrode. See Figure below.

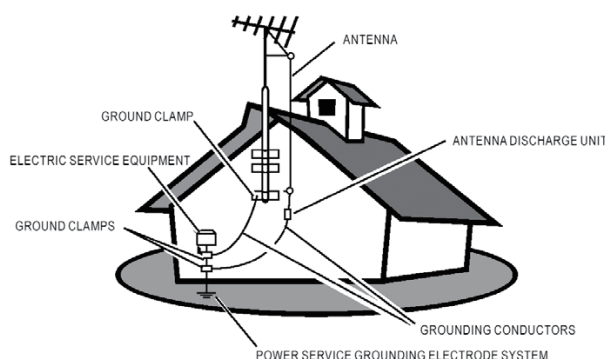

EXAMPLE OF ANTENNA GROUNDING AS PER NATIONAL ELECTRICAL CODE

Note to the CATV system installer: This reminder is provided to call the CATV system installer's attention to Article 820-40 of the NEC that provides guidelines for proper grounding and, in particular, specifies that the cable ground shall be connected to the grounding system of the building, as close to the point of cable entry as practical.

Please, make sure to connect the power plug to the wall outlet socket after connecting the TV to the adapter!

22. **Objects and Liquid Entry** – Care should be taken so that objects do not fall and liquids are not spilled into the enclosure through openings.

Quick Installation

Install

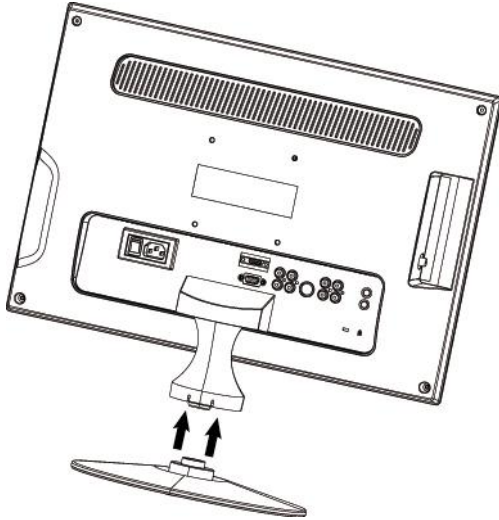

Install the stand base to the TV.

Remove

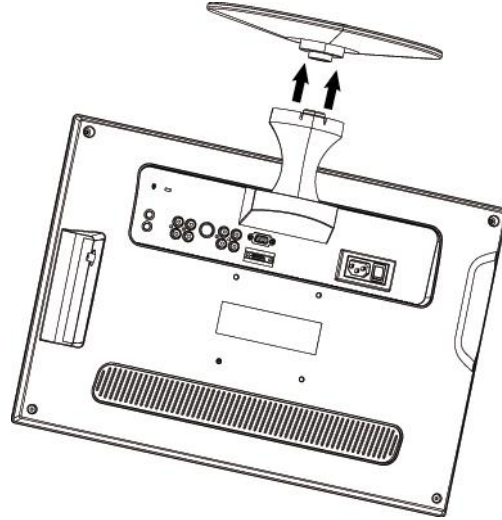

Remove the stand base from the TV.

Wall-mount instruction

Preparing To Install The Optional Wall Mount Arm (not included)

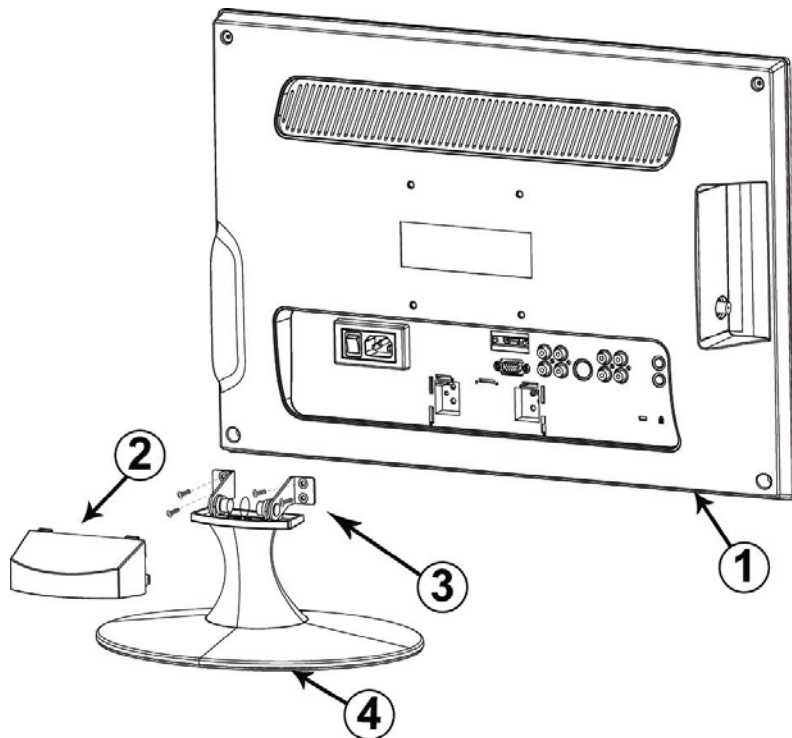

This TV can be attached to a wall mounting arm you can purchase separately.

Turn the power OFF then disconnect the cables from the TV before performing the procedure below.

- 1.Lay the TV face down on a soft surface.
- 2.Remove the hinge cover.
- 3.Remove the 4 screws holding the stand to the hinge.
- 4.Remove the stand.

Attaching The Optional Wall Mount Arm (not supplied)



Follow these steps to finish installing the wall mounting arm:

1. Place the wall mounting arm onto the back of the TV. Line up the holes of the arm with the holes in the back of the monitor.
2. Insert the 4 screws into the holes and tighten.
3. Reconnect the cables. Refer to the user's manual that came with the optional wall mounting arm for instructions on attaching it to the wall.

NOTE

- 100mmx100mm VESA high hole (n=4), M4, pitch =0.7 mm screw mounting kit not included.
- Due to safety concerns, if the VESA mounting kit is purchased separately please make sure the mounting kit is UL-Listed, and replaceable only by service personnel.

ACCESSORIES

Thank you for purchasing this LCD-TV.
This LCD-TV package comes with:

- LCD TV
- User's Guide book
- Remote control
- Battery AA x 2
- Power Cord
- Quick Setup Guide
- Pedestal stand

FRONT PANEL BUTTONS



①	Volume Up
②	Volume Down
③	On Screen Display Menu On/Off
④	CH Up
⑤	CH Down
⑥	Input Source Selection (Enter)
⑦	Power ON/OFF button
⑧	Power LED Indicator
⑨	Remote Control Receiver

BACK PANEL BUTTONS

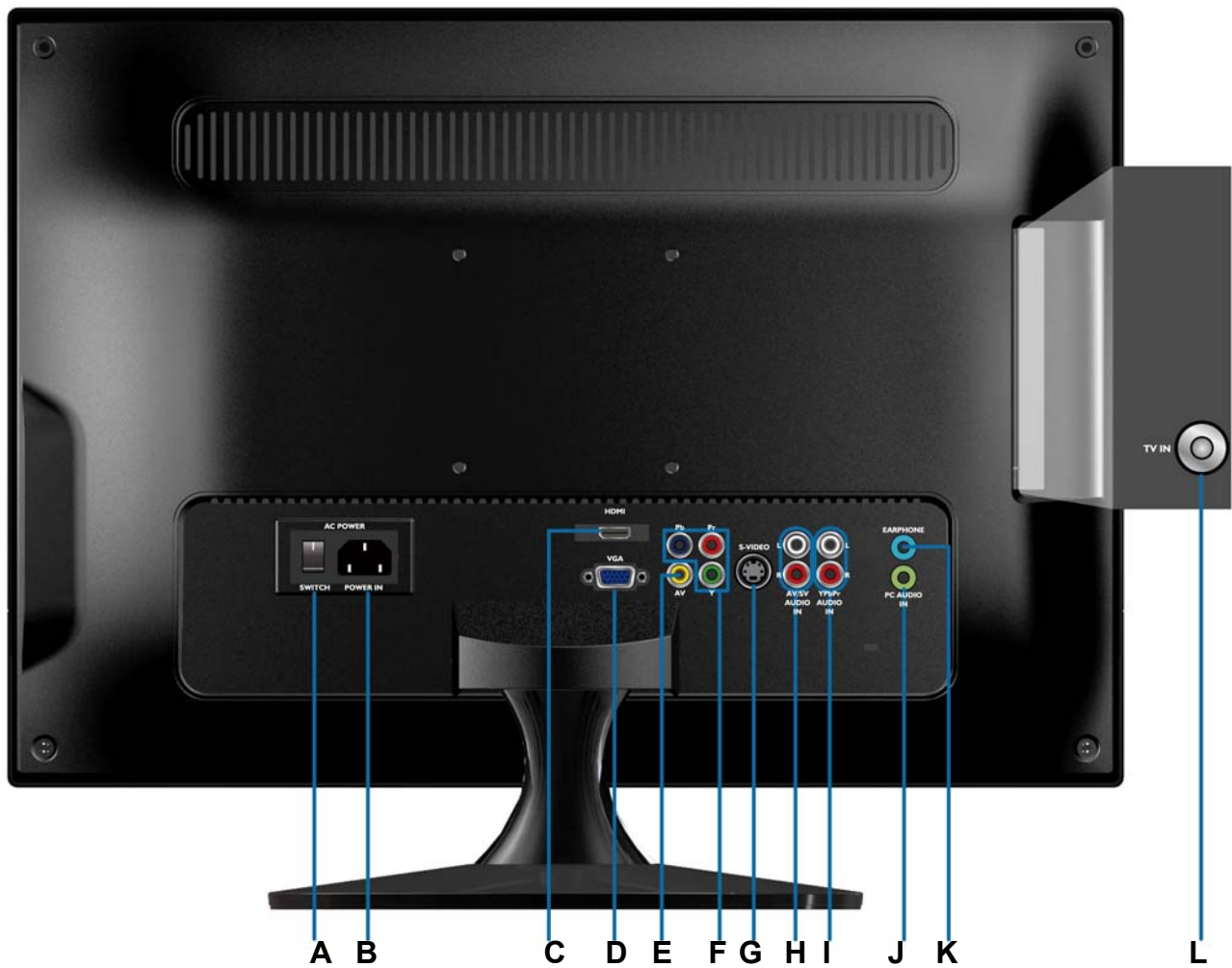

A	AC Power Switch (Must be turned on)
B	Power (AC input)
C	HDMI Input Terminal
D	VGA signal input
E	Composite Video input
F	YPbPr signal input
G	S-Video input
H	AV/ S-Video signal Audio input (left/right)
I	YPbPr signal Audio input (left/right)
J	PC Audio input
K	Headphone Jack
L	Cable/ Air TV input

REMOTE CONTROL

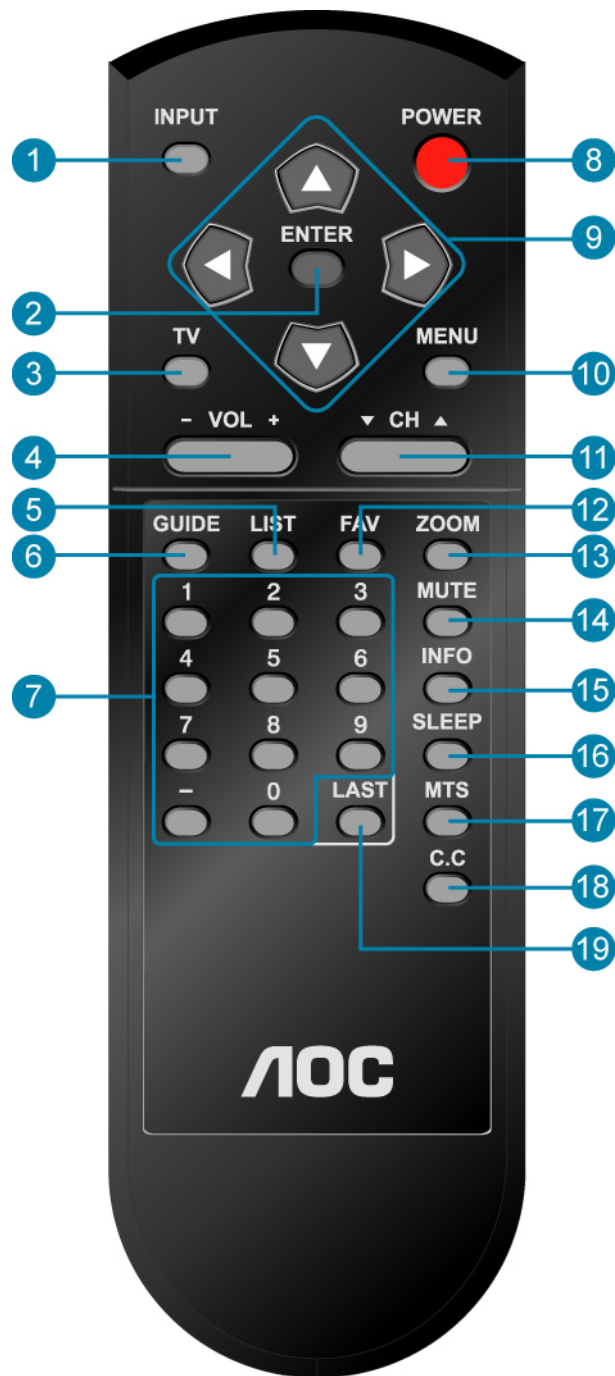

Remote control button function as follows:

1	INPUT	Input source select
2	ENTER	Confirm selection or enter selected menu
3	TV	Direct to TV source
4	- VOL +	Adjust volume UP/DOWN
5	LIST	Select channel from program list
6	GUIDE	Select electronic program guide (EPG) (Only available in DTV source)
7	0~9, - number	Directly channel select
8	POWER	Power ON/OFF
9	UP/ DOWN/ LEFT/ RIGHT	Move the cursor In OSD menu: UP/ DOWN for OSD function select and LEFT/ RIGHT for function adjust
10	MENU	On Screen Display (OSD) menu ON/OFF
11	▼ CH ▲	Adjust channel UP/DOWN
12	FAV	Select from preset Favorite Channels
13	ZOOM	Adjust window size
14	MUTE	Volume mute ON/OFF
15	INFO	Display current information
16	SLEEP	Set timer to turn off TV
17	MTS	Select Mono, Stereo or SAP sound
18	C.C	Select caption mode
19	LAST	Return to previous channel

INSTALLATION

Connecting RF antenna and Cable TV

Make sure the power is OFF before installing your LCD TV.

- 1) **AIR TV:** Connect the LCD TV to TV antenna with 75-ohm coaxial cable. Preset the air TV channels into memory with **Auto Scan** function when using an antenna TV system. This air input jack both support TV and DTV systems. Besides, the TV system (NTSC) and DTV system (ATSC) can be found by the scanning of "AIR" with **Auto Scan** function. See page 33.
- 2) **Cable TV:** Connect the LCD TV to the cable with CATV and Digital cable. Preset the cable TV channels into memory with **Auto Scan** function when using a cable TV system. The cable input jack both support CATV and Digital cable systems. Besides, the CATV system (cable TV) and Digital cable system (clear QAM) can be found by the scanning of "Cable" with **Auto Scan** function. See page 33.



Note: Users can select either Air or Cable TV cable to be connected to the TV IN jack. To watch both of them, use an adapter to connect both Air and Cable cables to the jack.

Connecting to DVD / Set Top Box

Connect Video/Audio cables from compatible devices into the back panel of LCD TV.

- 1) **With AV cable:**

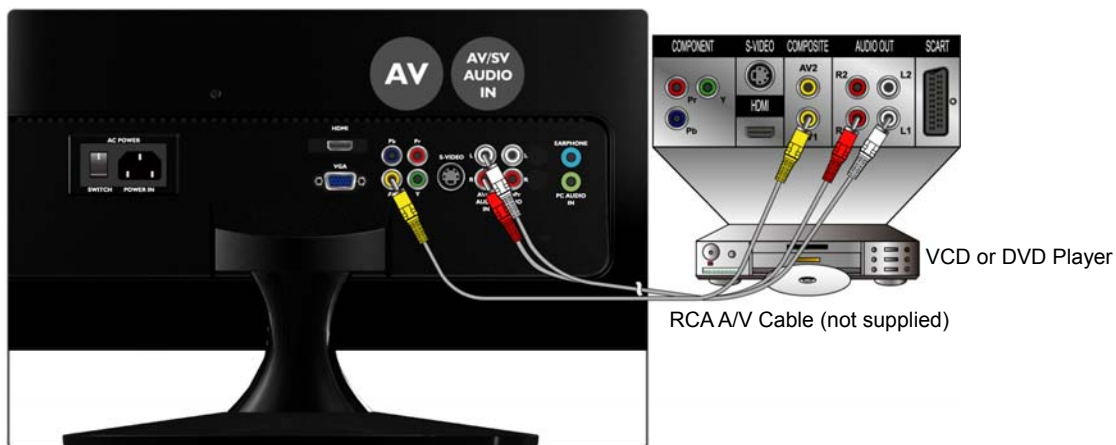

2) With S-Video cable:

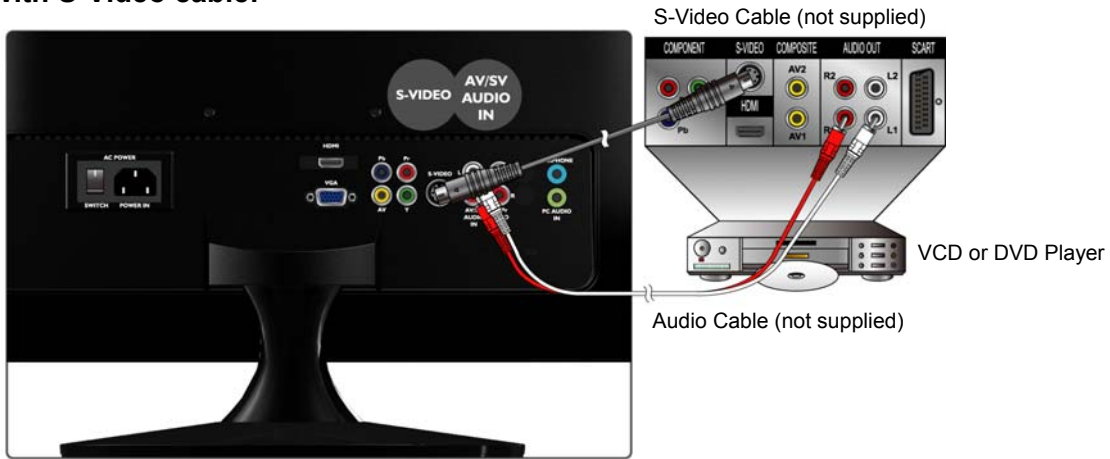

3) With YPbPr cable:

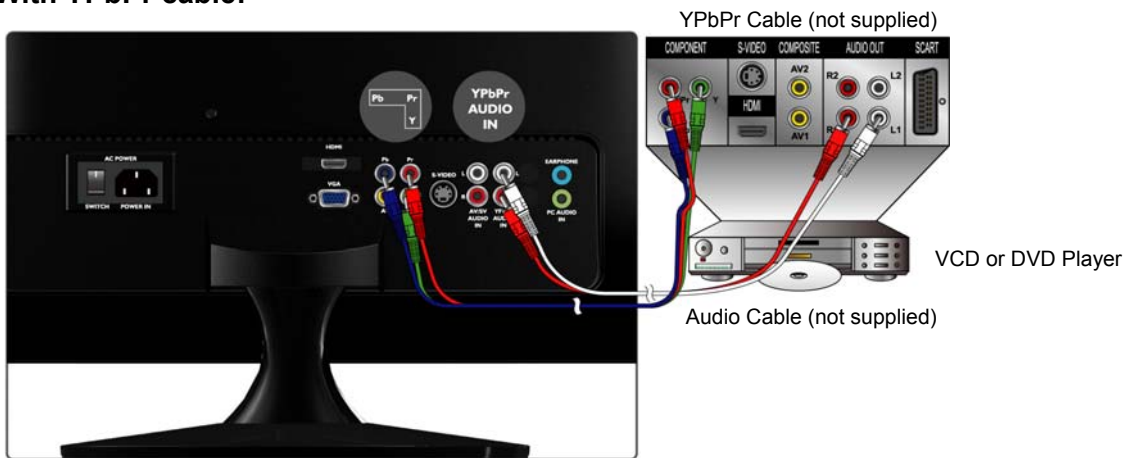

4) With HDMI cable:

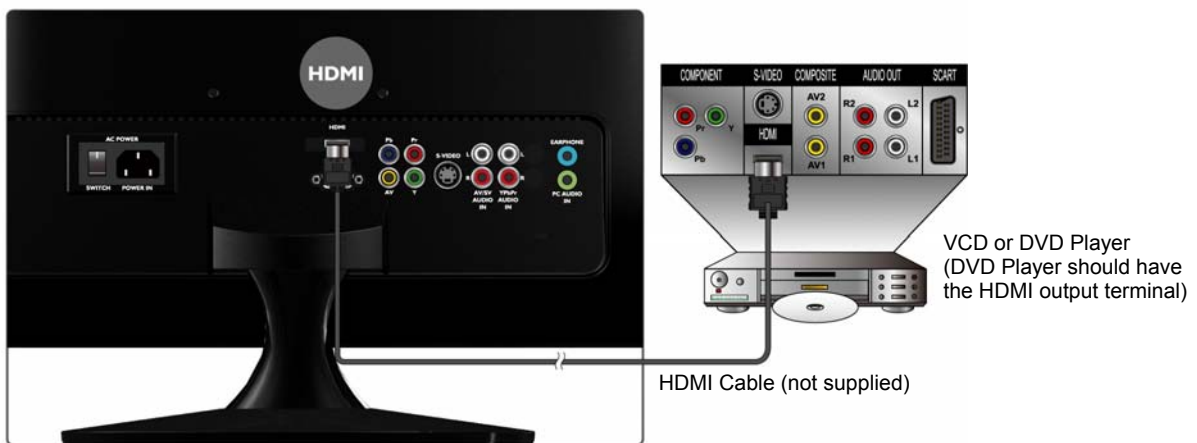

5) With HDMI-DVI cable:

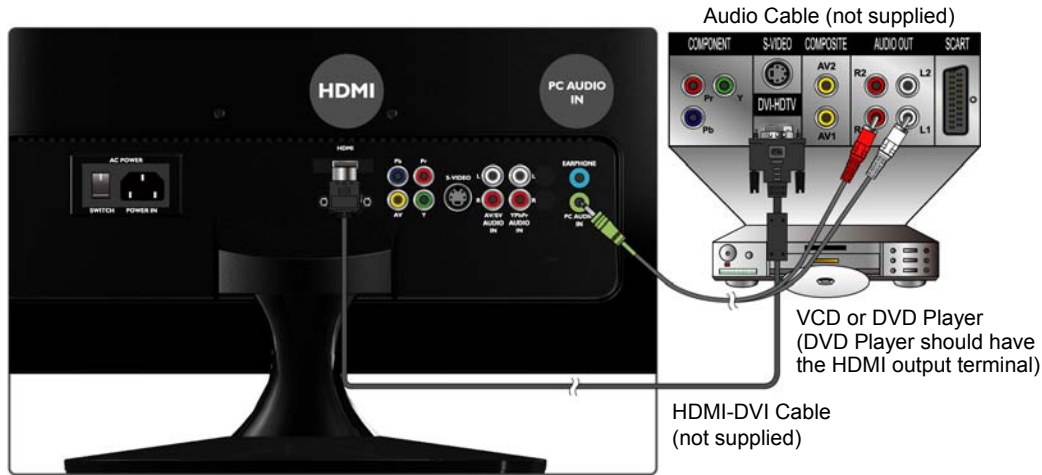

Connecting to the Headphone

Connect the headphone to the headphone output terminal of the LCD TV. (Headphone sold separately).



Connecting to a Computer

1) With VGA Cable:

Connect the VGA cable from VGA output of the computer to the VGA terminal input of your LCD TV. Also, connect the Audio In cable (green) from the audio output of your computer to the audio input terminal (green) of the LCD TV.

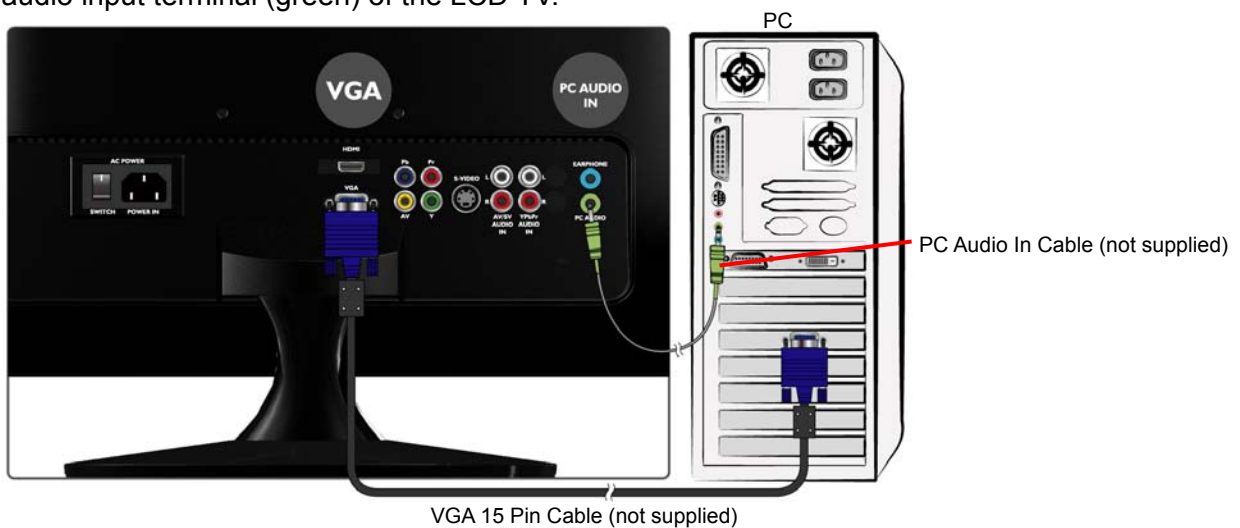

2) With HDMI-DVI Cable:

Connect the HDMI-DVI cable from the DVI output of the computer to the HDMI terminal input of the LCD TV. Also, connect the green end of the Audio In cable from the audio output of your computer to the audio input terminal (red/white) of the LCD TV.

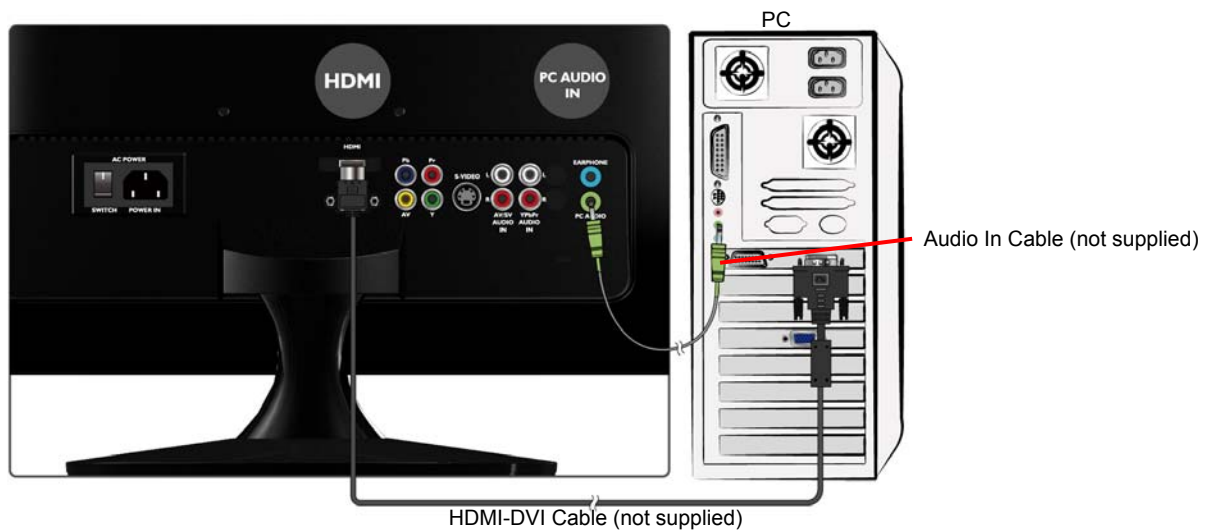

Connecting with the power cord

Connect the power cord to the AC inlet on the back of your LCD TV, after all connections have been completed, and plug the other end of the power cord into a correctly grounded electrical outlet.

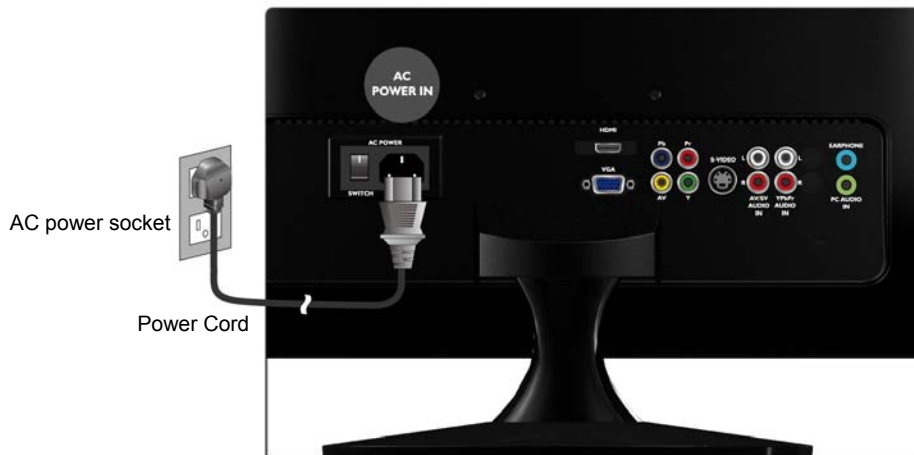

BASIC OPERATION

To operate your LCD TV, you may use the TV remote control or bottom panel buttons to select input source, change channels, or adjust volume.

Turning on the LCD TV

Before using the LCD TV:

1. Connect external equipment properly.
2. Insert the power plug and the power LED indicator will light orange.

Power On/Off

To turn the LCD TV on/off :

Press the **POWER** button under the LCD TV, or press the **POWER** button on your remote control to turn on/off the TV. The power LED indicator lights blue when the LCD TV is on.

Select input source

To select the required input source:

Press the **INPUT** button on the remote control, Use **▲ ▼** to select the required input source between TV, AV, S-Video, YPbPr, HDMI, and PC.

To confirm the selection, press **ENTER**.



Volume Adjusting

Press – **VOL +** to adjust volume.

To turn off the volume, press **MUTE**.

If you want to restore volume, press **MUTE** again, or press – **VOL +** directly.

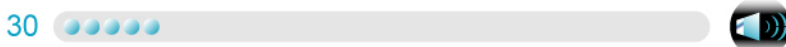

INFO

To display the current information of the LCD TV: Press **INFO**, and the current state will be displayed on the screen. (It shows all or some of the information about Input, Channel, Resolution, Audio Type, etc., depending on what input source it is in.)



* The picture here shows an example of the INFO screen in a DTV source.

Electronic Program Guide (EPG)

Press the **GUIDE** button on the remote control and the program information for the channel you are watching will be displayed on the screen. This function is only available when in DTV source.



* The picture here shows an example of the GUIDE screen in a DTV source.

Channel Select

Press number key or **▼CH▲** button to select your desired channel.

1. ATV

The “-” button has no function in ATV mode. Directly press the number buttons to select channels.

2. DTV

Use “-” button to select the sub channel in DTV.

Ex: Your desired number is 80-3.

Press **8** → press **0** → press “-” → press **3**.

- Whether in ATV or DTV, after you input the channel numbers, press **ENTER** button to direct to the channel immediately, or wait for 3 seconds to change automatically.
- Return to the previous channel, press **LAST** button.

Note: Please refer to channel menu on page 33. for TV channels set up when initial use.

List

Press **LIST** button and there will be a small window showing program list, you can scroll through the list to select the channel you want directly without using the **▼▲** button.

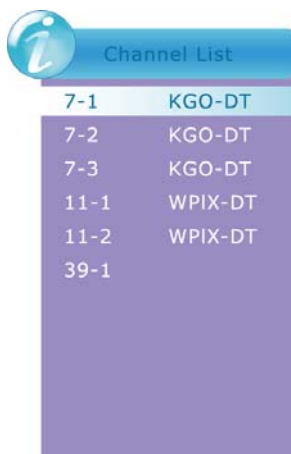

Favorite Channels

Press FAV button to show Favorite List and select your favorite channels that have already been stored. (You need to preset the favorite channels from the OSD menu to enable this function.)

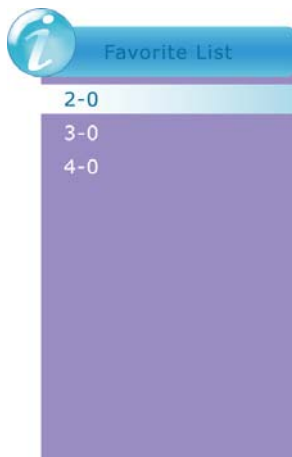

Sleep Time Setting

Repeatedly press **SLEEP** button to set the off timer. The function is used to automatically shut off the LCD TV after a preset period of time passed. There are several times for choice – Off, 5min, 10min, 15min, 30min, 45min, 60min, 90min, 120min, 180min, 240min.

Zoom

Press **ZOOM** button repeatedly to select the screen size. You can select from Full, 4:3, Movie Scale, and Zoom In.

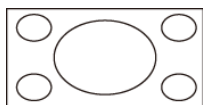

Full: Suitable for stretching 4:3 programs to fill the screen.

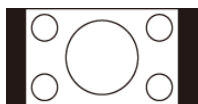

4:3: Suitable for viewing conventional 4:3 programs in their normal format.

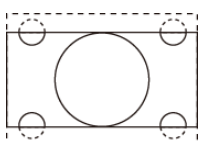

Movie Scale: This mode is useful for 1.78:1 DVDs, When viewing 1.85:1 DVDs movie scale mode will still show very thin black bands at the top and bottom of the screen.

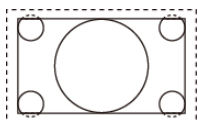

Zoom In: Suitable for viewing wide-screen 2.35:1 anamorphic DVDs in full screen.

* only in DTV source.

Note: When the resolution is or above 720p, the selections of Movie Scale and Zoom In are not supported in DTV.

MTS Selecting

Press **MTS** button to choose the available sound output that is preset by TV broadcasting station.

C.C Mode

Press **C.C** button to select the caption mode.

Using the OSD function

You can use the OSD menus and options to adjust various settings by using the remote control. The basic operation is as following:

- ◆ Press **MENU** to display OSD menu.
- ◆ Press ◀▶ to select your desired top Menu, and press **ENTER** or ▼ to enter the menu you select.
- ◆ Use ▲▼ to select the control you want to adjust.
- ◆ When selecting the control with ▶, press ▶ to enter next level menu or enable the function.
- ◆ Press ◀▶ to adjust or select the settings.
- ◆ Press **MENU** to exit from the OSD menu.

ADVANCED OPERATION—OSD MENU

PICTURE Menu

—To adjust the picture quality

In TV, AV, S-Video, YPbPr, HDMI source:

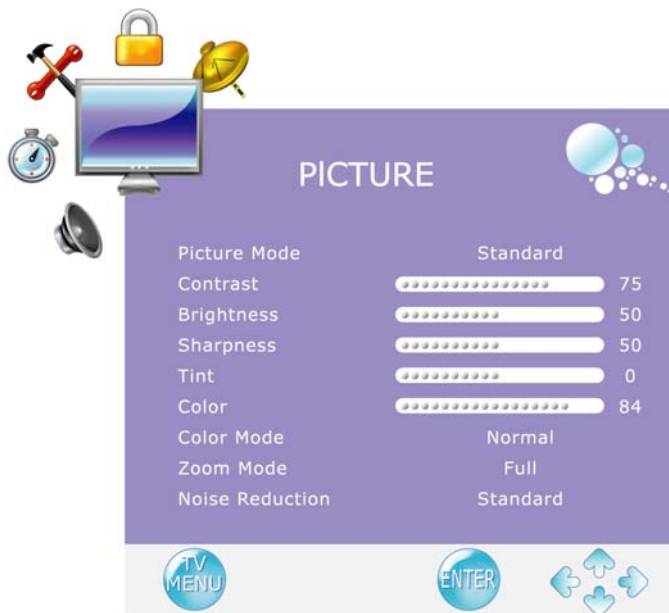

Note: The CHANNEL Menu icon on the screen will disappear in AV, S-Video, YPbPr, and HDMI sources.

In PC source:

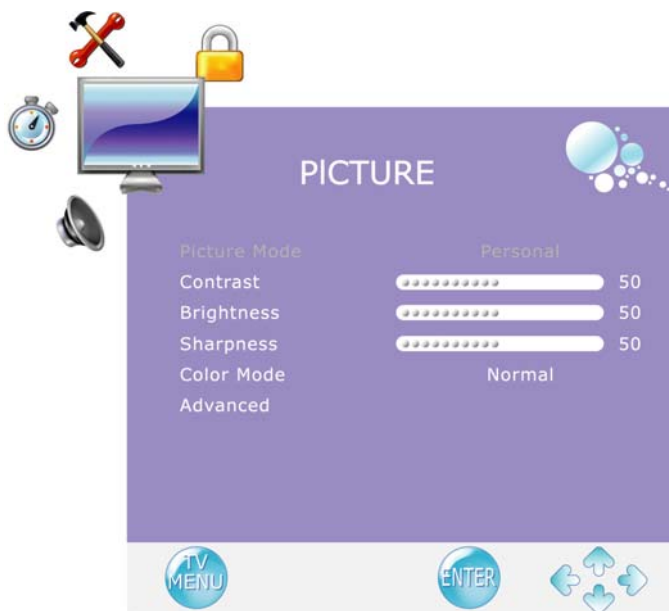

- **Picture Mode:** To select picture mode between Standard, Dynamic, Soft, and Personal.
- **Contrast:** To adjust contrast of video. (right: Max, left: Min.)
- **Brightness:** To adjust luminance of video. (right: Max, left: Min.)
- **Sharpness:** To adjust picture sharpness. (right: sharper, left: softer.)
- **Tint:** To adjust tint level.
- **Color:** To adjust color. (right: brilliant color, left: pale color.)
- **Color Mode:** To select color mode from Normal, Warm, or Cool.

- **Zoom Mode:** To select image size from Full, 4:3, Movie Scale, or Zoom In.
- **Noise Reduction:** To select noise restriction function from Standard, Strong, Off, or Weak. (Not supported in or above 720p)
- **Advanced:** To adjust advanced PC functions, press ► to enter. (only appear in PC source)

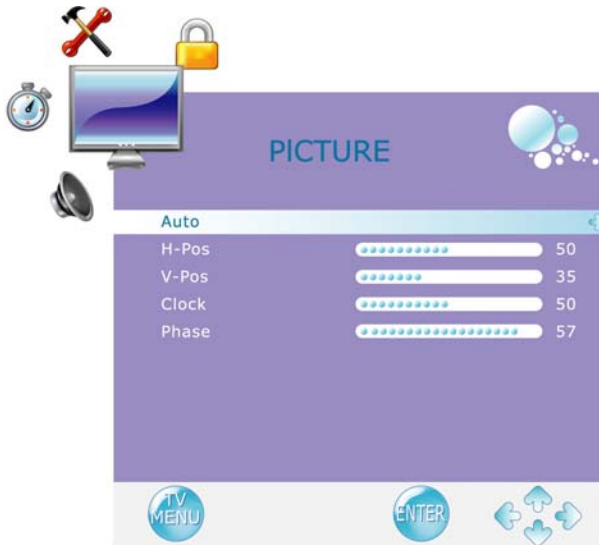

- ◆ **Auto:** To auto adjust picture's horizontal position, vertical position, fine tune and H-Size.
- ◆ **H-Pos:** To adjust the horizontal position of the picture.
- ◆ **V-Pos:** To adjust the vertical position of the picture.
- ◆ **Clock:** To adjust clock frequency in order to get optimized horizontal size.
- ◆ **Phase:** To adjust delay time of phase in order to reduce the noise of picture.

AUDIO Menu

—To set the audio quality and status

In DTV source:



In ATV source:



In AV, S-Video, YPbPr, HDMI, PC source:



- **Sound Mode:** To select sound mode between Standard, Music, Movie, Sports, and Personal.
- **Treble/Bass:** To adjust the treble, bass or balance.
- **Prefer Language:** To select the available audio languages. (only enabled in DTV mode)
- **MTS:** Press ◀▶ to select the audio language from STEREO, SAP or Mono. (only appears in ATV source)
- **Surround Sound:** To enjoy a concert hall effect, select “On” when stereo is playing.
- **Audio Only:** To turn off the screen picture but keep the sound on. (it is disabled in some sources)

TIME Menu

—To set up time zone



Note: The CHANNEL Menu icon on the screen will disappear in AV, S-Video, YPbPr, HDMI, and PC sources.

- **Sleep Timer:** Off, 5min, 10min, 15min, 30min, 45min, 60min, 90min, 120min, 180min, 240min.
- **Time Zone:** To select the correct Time Zone for your area.
- **DST:** To turn on/off summer Daylight Saving Time.
- **Time Format:** To select time format from 12-hour or 24-hour.
- **Auto Sync:** To enable automatic synchronization of time.

- **Clock:** To adjust the current time. Press ► to enter. Use ◀▶ to move between Year, Month, Date, Hour, Minute, and use ▲▼ to adjust. Select **OK** and press **ENTER** to save the setting.
- * The “Clock” time can only be adjusted manually, when “Auto Sync” is set to “Off”.

OPTION Menu

—To set up OSD window

In TV, AV, S-Video source:



Note: The CHANNEL Menu icon on the screen will disappear in AV and S-Video sources.

In YPbPr, HDMI, PC source:



- **Menu Language:** To select an OSD language from English, French or Spanish.
- **Transparency:** To change the transparency of OSD window. (0%, 25%, 50%, 75%, 100%)
- **OSD Time Out:** To setup the display time of OSD. (5, 15, 30, 45, and 60 seconds)

- **Closed Caption:** To set close caption options.



- ◆ **CC Mode:** To select Closed Caption Mode from CC Off, CC On, or CC on Mute.
- ◆ **Basic Selection:** To set basic analog closed caption options. (CC1~CC4, TEXT1~TEXT4, or Off)
- ◆ **Advanced Selection:** To select closed caption signal formats and set up caption modes for digital TV channels. (Service1~6, or Off) *only in DTV source.
- ◆ **Option:** Press ◀▶ to select Mode from Default or Custom. When “Custom” is selected, use ▲▼ to select the desired controls, ◀▶ to adjust detailed settings. *only in DTV source.



- **DCR:** To turn on/off the DCR (Dynamic Contrast Ratio) function.
- **Restore Default:** To restore the factory default settings.

LOCK Menu

—To set up parental control

In TV, AV, S-Video, YPbPr, HDMI, PC source:



Note: The CHANNEL Menu icon on the screen will disappear in AV, S-Video, YPbPr, HDMI, and PC sources.

- **Enter Password:** Enter password and the screen below will show. (The default password is 0000.)



Note: Some options will be disabled when in YPbPr, HDMI, or PC source.

- **Change Password:** To change the password, press ►, and the screen on the right appears. Follow the instructions to change password.
- **System Lock:** Select “On” to enable the following options.
Note: The below options can be enabled only when “On” is selected here.
- **Unrated Lock:** Select “On” to block unrated movies or TV programs.
- **Input Block:** To set the input source to be blocked.

- **US:** Press ► to set TV or MPAA ratings.



- ◆ **TV:** To adjust TV blocking level in the US.

The following screen will allow you to customize the following TV ratings:

TV-Y (all children)	TV-PG (guidance suggested)
TV-Y7 (older children)	TV-14 (strongly cautioned)
TV-G (general audience)	TV-MA (mature audience)

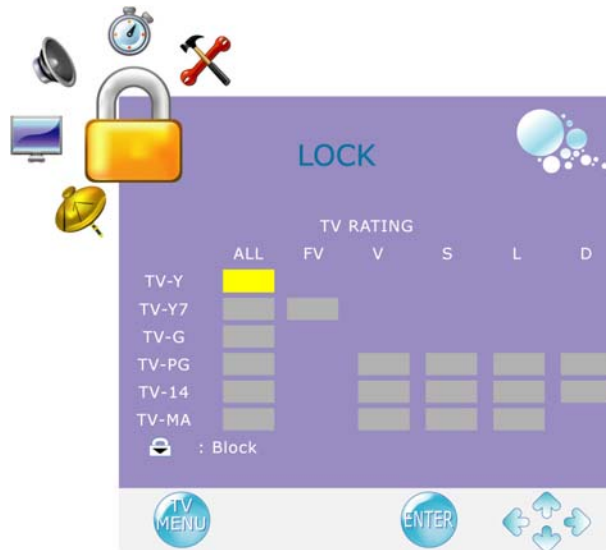

You can also customize the TV ratings for the following content:

ALL (All types of content)	S (sexual situations)
FV (fantasy violence)	L (adult language)
V (violence)	D (sexual dialog)

- ◆ **MPAA:** To adjust movie blocking level in the US. You can select between G, PG, PG-13, R, NC-17, X, or N/A.



The movie Ratings in the US are defined as following:

G (general audience)	NC-17 (no one under 17 years of age)
PG (parental guidance suggested)	X (adult audience only)
PG-13 (recommended for children 14 years of age or older)	N/A (Not applicable)
R (mature audience)	

- **Canada:** Press ► to set Canadian English and French ratings.



- ◆ **Canada Eng:** To adjust blocking level in English-speaking region of Canada. You can select between C, C8+, G, PG, 14+, 18+, EXEMPT.



The Canadian English Ratings are defined as following:

C (children)	14+ (viewers and older)
C8+ (children eight years and older)	18+ (adult programming)
G (general programming, suitable for all audiences)	EXEMPT
PG (parental guidance)	

- ◆ **Canada Fre:** To adjust blocking level in French-speaking region of Canada. You can select between G, 8 ans +, 13 ans +, 16 ans +, 18 ans +, EXEMPT.



The Canadian French Ratings are defined as following:

G (general)	16 ans+ (not appropriate for children of less than 16 years)
8 ans+ (children eight years and older)	18 ans+ (reserved to adults)
13 ans+ (not appropriate for children of less than 13 years)	EXEMPT

- **RRT Setting:** To set Rating Region Table that defines the rating standard for a particular geographic region and/or country. Press ► to enter the setting.
- **Reset RRT:** Press ► to reset RRT Setting.

CHANNEL Menu

—To set up for TV

Note: The Channel Menu is only active in TV source. When in AV, S-Video, YPbPr, HDMI, or PC source, the CHANNEL Menu will not appear.

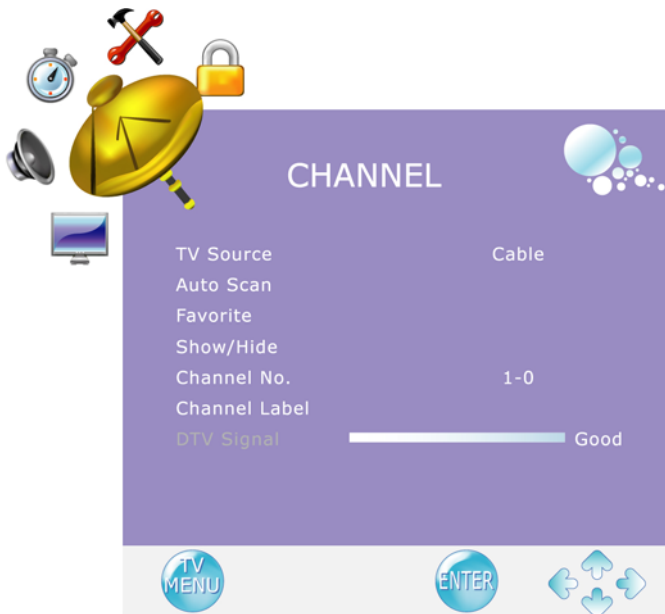

Note: The condition of DTV Signal will only be displayed when source is in DTV.

- **TV Source:** To select Cable or Air as the TV source.
- **Auto Scan:** To auto scan the TV or DTV channels. Select Air or Cable in TV option, and press ► to start auto scanning TV channels. Press **MENU** again at any time to interrupt scanning.



- **Favorite:** To set your favorite channels into memory. Press **ENTER** to confirm/ cancel your favorite channels. Press **◀ / ▶** to go to previous / next page.

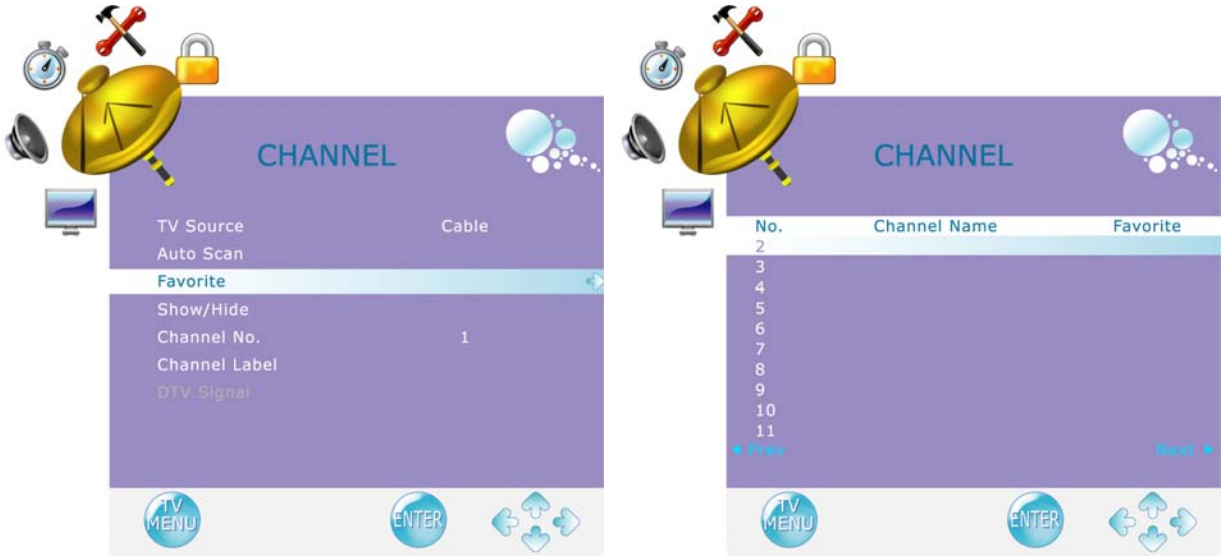

- **Show/Hide:** Press **ENTER** to skip the selected channel. To restore the channel, press **ENTER** again.



- **Channel No.:** Press **◀▶** to select a channel. The channel selected will be shown on the screen at the same time.



- **Channel Label:** Press ► to edit a name for the current channel (the channel selected in Channel No.). Use ▲▼ to choose letters or signs, ◀▶ to move forward or backward, and then press **MENU** or **ENTER** to exit.



- **DTV Signal:** To display the detected signal strength of the current DTV channel.

TECHNICAL SPECIFICATION

LCD	Type	21.5" TFT Active Matrix 0.248 (H) x 0.248 (V) pixel pitch
	Color Filter	RGB vertical stripe
	Glass surface	Anti-Glare
Input signal	RGB	RGB analog (0.7/1.0 Vp-p, 75 ohms) Separate Sync, fh: 30-80 kHz, fv:50-75 Hz
	RF	TV system Antenna / NTSC+ATSC TV Cable system / CATV + Digital Cable
	Video	1 composite RCA, 1 S-Video, 1 YPbPr component, 1 HDMI
	Audio	1 mini-stereo, 2 pair of RCA (L/R) stereo
Compatibility	PC	Up to 1920 x 1080 Non-interlaced
Resolution	Recommended and supported	1920 x 1080 @ 60 Hz 1680 x 1050 @ 60 Hz 1440 x 900 @ 60 Hz 1280 x 1024 @ 60 Hz 1280 x 768 @ 60 Hz 1024 x 768 @ 60, 75 Hz 800 x 600 @ 60, 75 Hz 640 x 480 @ 60, 75 Hz
Speaker Output		3W x 2
Audio Output		1 Headphone jack
Power	Voltage	100-240 VAC, 50/60 Hz (auto switch)
Display area	Full Scan	477.504 mm (H) x 268.596 mm (V) 18.8" (H) x 10.6" (V)
Operating conditions	Temperature	32°F to + 104°F (0°C to + 40°C)
	Humidity	20% to 65% (no condensation)
	Altitude	To 7,000 feet (2,000m)
Storage condition	Temperature	-4°F to + 140°F (-20°C to + 60°C)
	Humidity	20% to 90% (no condensation)
	Altitude	To 40,000 feet (12,000m)
Dimensions	Physical	518.3mm (W) x 427.8mm (H) x 216.0mm (D) 20.4" (W) x 16.8" (H) x 8.5" (D)
Weight (Net)	With stand	6.0 kg (13.2 lb)
	Without stand	5.6 kg (12.3 lb)
Regulations		UL, FCC-B (Doc-B)
Power saving modes	On	< 55 W (blue LED)
	Stand by	Max 1W, typical: 0.9W (orange LED)
Preset Timing Mode (Pre-adjusted to GTF® 1920 x 1080 @ 60 Hz)		
Warning: Do not set the graphics card in your computer to exceed these refresh rates; doing so may result in permanent damage to the LCD TV		

Note: Product Specifications are subject to change without notice.

SAFETY PRECAUTIONS

This LCD TV is manufactured and tested to insure the user's safety. Improper use or installation may result danger to the LCD TV as well as to the user. Carefully go over the following WARNINGS before installation and keep this guide handy.

WARNINGS

- This LCD TV should be operated only at the correct power sources indicated on the label on the rear end of the LCD TV. If you're unsure of the power supply in your residence, consult your local dealer or power company.
- Do not try to repair the LCD TV yourself as it contains no user-serviceable parts. The LCD TV should only be repaired by a qualified technician.
- Do not remove the LCD TV cabinet. There is high-voltage parts inside that may cause electric shock. even when the power cord is disconnected .
- Stop using the LCD TV if the cabinet is damaged. Have it checked by a service technician.
- Put your LCD TV only in a clean, dry environment. Unplug the LCD TV immediately if gets wet and consult your service technician.
- Always unplug the LCD TV before cleaning it. Clean the cabinet with a clean, dry cloth. Apply non-ammonia based cleaner onto the cloth, not directly onto the glass screen.
- Keep the LCD TV away from magnetic objects, motors, TV sets, and transformer.
- Do not place heavy objects on the cable or power cord.
- For PLUG CABLE EQUIPMENT, the Socket-outlet shall be installed near the equipment and shall be easily accessible.

CARE AND MAINTENANCE

Care

- Avoid exposing your LCD TV directly to sunlight or other heat source.
- Place your LCD TV away from the sun to reduce glare.
- Put your LCD TV in a well ventilated area. Do not place anything heavy on top of your LCD TV.
- Make certain your LCD TV is installed in a clean and moisture-free area.
- Keep your LCD TV away from magnets, motors, transformers, speakers, and TV sets.

Safety Tips

- If smoke, abnormal noise or odor came out of your LCD TV, remove the power cord immediately and call your service center.
- CAUTION-Never remove the rear cover of your LCD TV cabinet. The display unit inside contains high-voltage parts and may cause electric shock to human bodies.
- Never try to repair your LCD TV yourself. Always call your service center or a qualified technician to fix it.

TROUBLESHOOTING

No power

- Make sure A/C power cord is securely connected.
- Plug another electrical device into the power outlet to verify that the outlet is supplying proper voltage.

Power on but no screen image

- Make sure the video cable supplied with the TV is tightly secured to the video output port on back of video source (DVD, VCR...). If not, tightly secure it.
- Adjust brightness.
- Make sure all signal cables are installed.

Wrong or abnormal colors

- If any colors (red, green, blue) are missing, check the video cable to make sure it is securely connected. Loose or broken pins in the cable connector could cause an improper connection.
- Connect the TV unit to another video source or use another TVs to make sure the video source was not causing the problem.

Free Manuals Download Website

<http://myh66.com>

<http://usermanuals.us>

<http://www.somanuals.com>

<http://www.4manuals.cc>

<http://www.manual-lib.com>

<http://www.404manual.com>

<http://www.luxmanual.com>

<http://aubethermostatmanual.com>

Golf course search by state

<http://golfingnear.com>

Email search by domain

<http://emailbydomain.com>

Auto manuals search

<http://auto.somanuals.com>

TV manuals search

<http://tv.somanuals.com>