

## Smart-UPS® Quick-Start Guide 750/1000/1500/2200/3000 VA 120/208/230 Vac RM2U

### Inventory / Inventaire / Inventario / Lieferumfang / Contenuto

All Models / Tous les modèles / Todos los modelos /  
Alle Modelle / Tutti i modelli

2200/3000 VA models /  
Modèles 2200/3000 VA /  
Modelos de 2200/3000 VA /  
2200/3000-VA-Modelle /  
Modelli da 2200/3000 VA

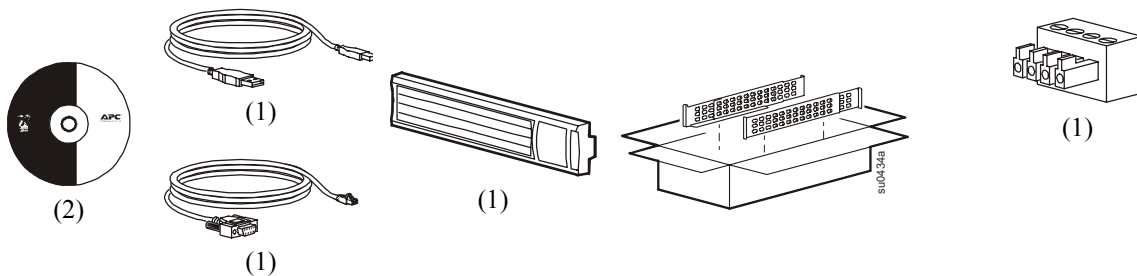

230 Vac Models / Modèles 230 V CA / Modelos de 230 V de CA / 230-VAC-Modelle / Modelli da 230 V c.a.

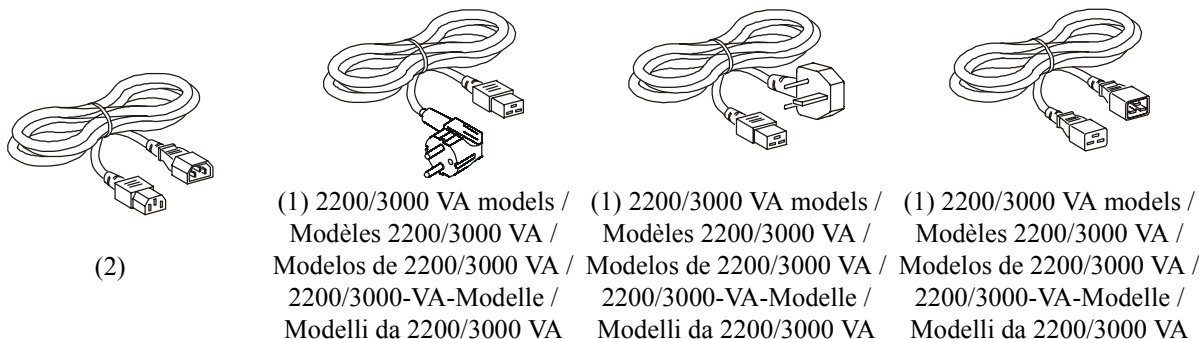

### Installation / Installation / Instalación / Einbau / Installazione



**Heavy:** The UPS is heavy, before installing the unit in a rack, remove the battery.

**Lourd :** l'onduleur est lourd. Retirez la batterie avant d'installer l'unité dans un rack.

**Carga pesada:** El SAI es pesado, antes de instalar la unidad en un armario extraiga la batería.

**Schwer:** Die USV ist schwer; vor der Installation der Einheit in einem Rack die Batterie entfernen.

**Pesante:** l'UPS è un'apparecchiatura pesante; prima di installare l'unità su rack, rimuovere la batteria.

750 VA Unit / Unité 750 VA / Unidad de 750 VA / 750-VA-Einheit / Unità da 750 VA

1

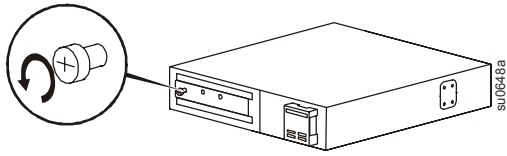

2

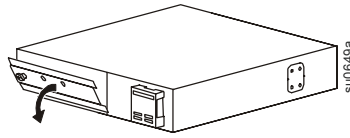

3

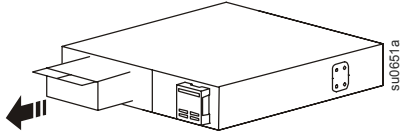

4

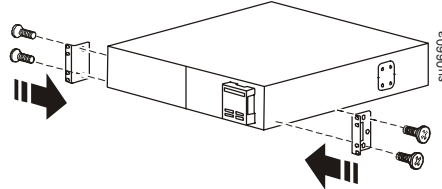

5

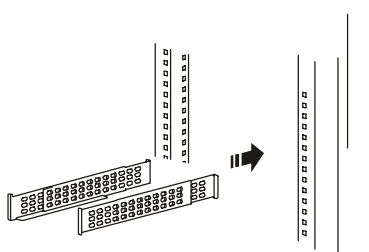

6

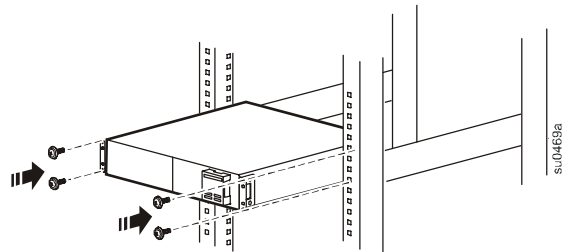

7

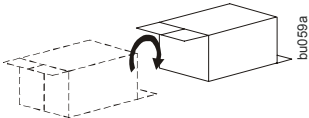

8

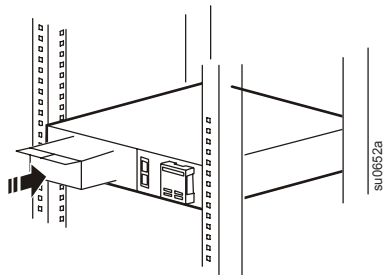

9

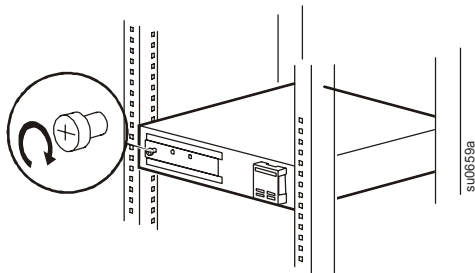

10

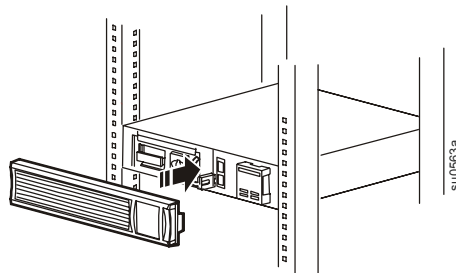

**1000/1500 VA units / Unités 1000/1500 VA / Unidades de 1000/1500 VA / 1000/1500-VA-Einheiten / Unità da 1000/1500 VA**

**1**

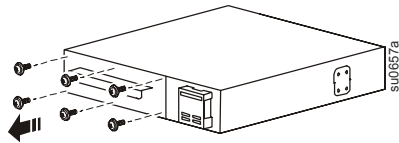

**2**

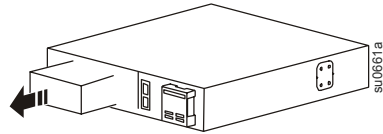

**3**

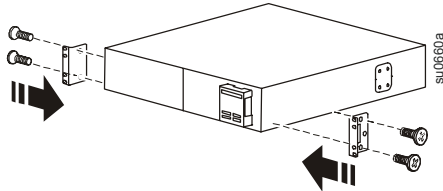

**4**

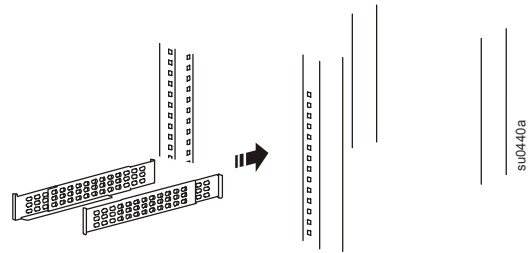

**5**

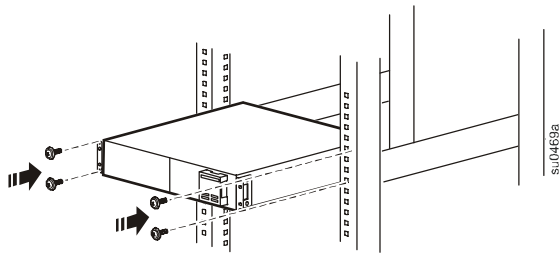

**6**

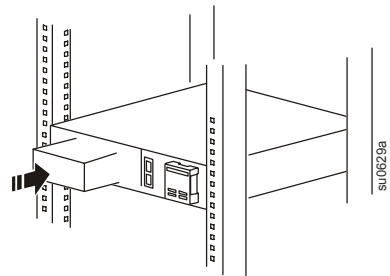

**7**

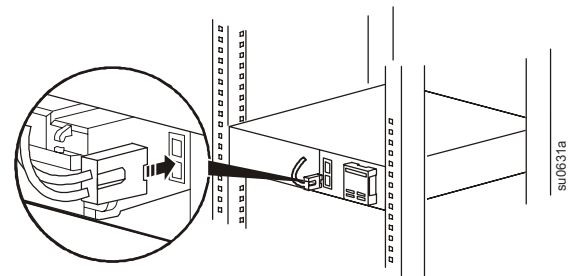

**8**

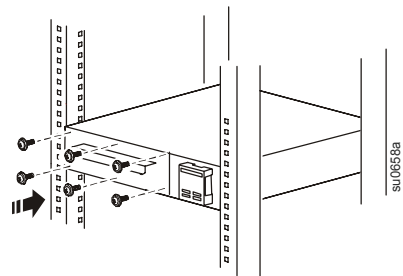

**9**

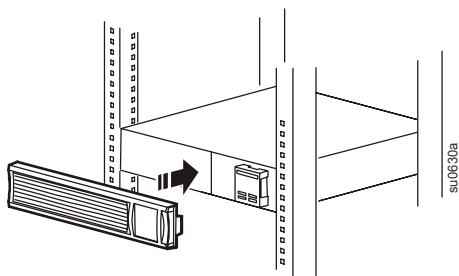

**2200/3000 VA units / Unités 2200/3000 VA / Unidades de 2200/3000 VA / 2200/3000-VA-Einheiten / Unità da 2200/3000 VA**

**1**

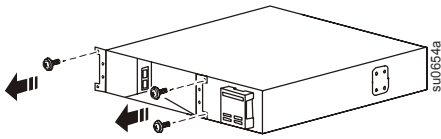

**2**

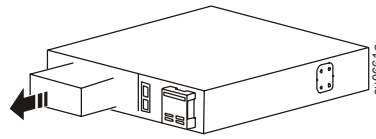

**3**

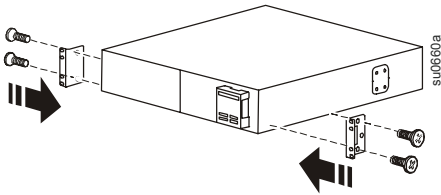

**4**

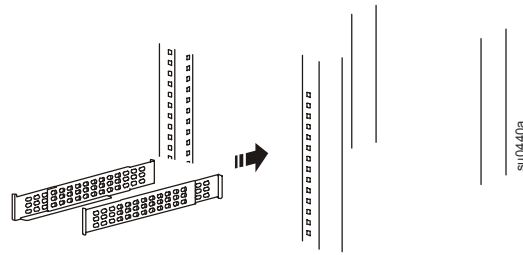

**5**

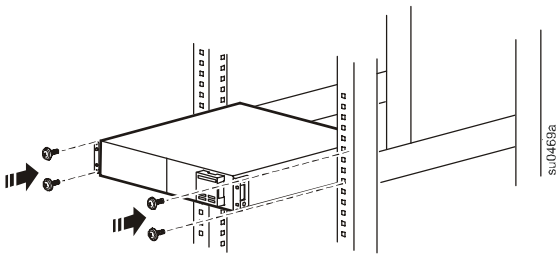

**6**

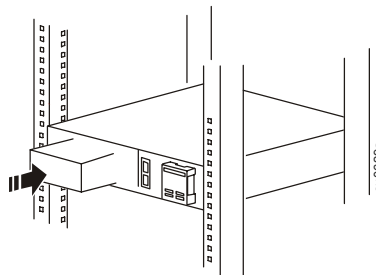

**7**

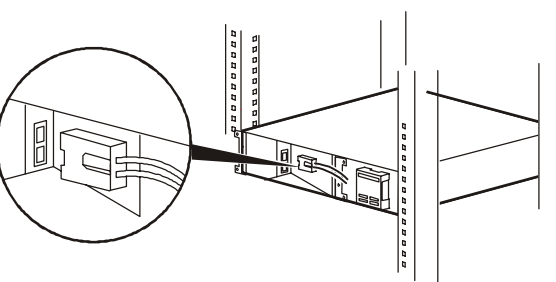

**8**

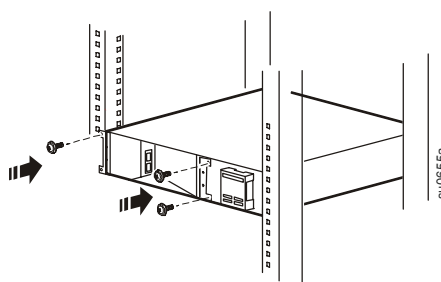

**9**

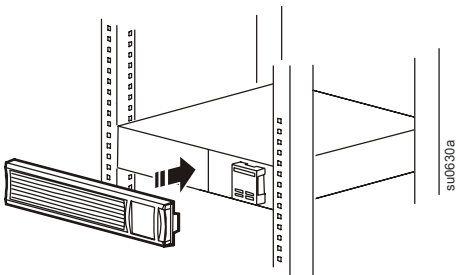

# Overview and Start-Up / Présentation et démarrage / Visión general e inicio / Übersicht und Inbetriebnahme / Panoramica e avvio

- ❶ SmartSlot for optional NMC accessory card / SmartSlot pour carte de gestion réseau en option / SmartSlot para tarjeta de accesorios NMC opcional / SmartSlot für optionale NMC-Zubehörkarte / SmartSlot per scheda NMC accessoria opzionale
- ❷ UPS input / Entrée de l'onduleur / Entrada del SAI / USV-Eingang / Ingresso dell'UPS
- ❸ Circuit breaker/Overload protection / Disjoncteur/protection contre les surcharges / Disyuntor de circuito / protección de sobrecarga / Leistungsschutzschalter/Überspannungsschutz / Interruttore automatico/Protezione da sovraccarico
- ❹ Controlled outlet group / Groupe de sorties contrôlées / Grupo de tomacorrientes controlables / Gesteuerte Ausgangsgruppe / Gruppo di prese controllate
- ❺ Chassis ground connection screw (TVSS GND) / Vis de connexion à la masse du châssis (TVSS GND) / Tornillo de conexión a tierra del chasis (TVSS GND) / Masseschraube des Gehäuses (TVSS GND) / Vite di collegamento a terra per chassis (TVSS GND)
- ❻ Outlets / Sorties / Tomacorrientes / Ausgänge / Prese
- ❼ EPO connector / Connecteur EPO / Conector de EPO / Notabschaltung (EPO-Anschluss) / Connettore EPO
- ❽ USB port / Port USB / Puerto USB / USB-Anschluss / Porta USB
- ❾ RJ45 connector - serial UPS monitoring port / Connecteur RJ45, port de surveillance de l'onduleur série / Conector RJ45 - puerto de supervisión del SAI serie / RJ45-Anschluss – serieller USV-Überwachungsport / Connettore RJ45 – Porta seriale di monitoraggio dell'UPS

750/1000/1500 VA 120 V

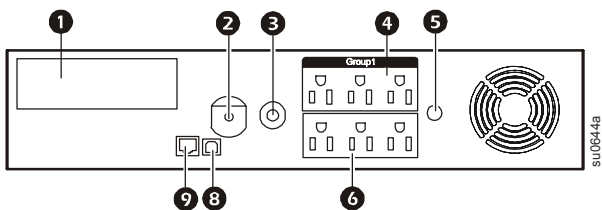

3000 VA 120 V

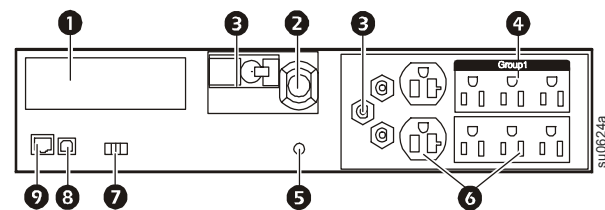

750/1000/1500 VA 230 V

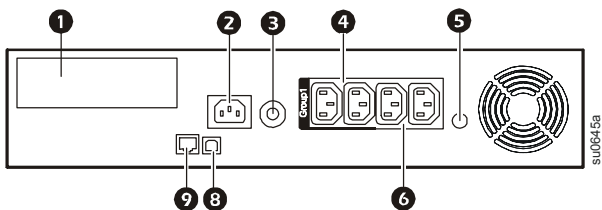

3000 VA 208 V

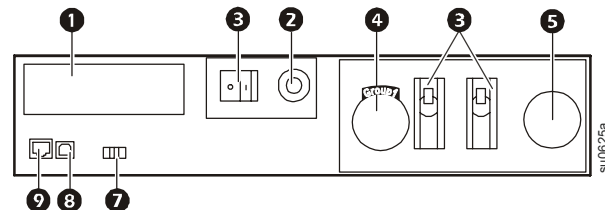

2200 VA 120 V

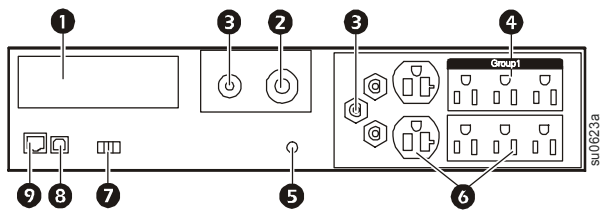

2200/3000 VA 230 V

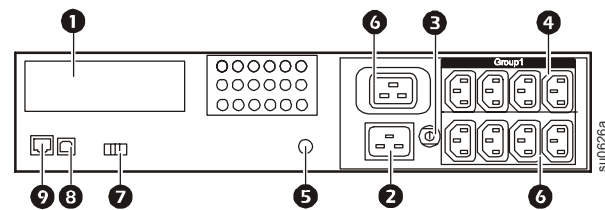

## Electrical connections / Connexions électriques / Conexiones eléctricas / Elektrische Verbindungen / Collegamenti elettrici

Plug type and connector locations may vary / Les types de prise et l'emplacement des connecteurs peuvent varier / El tipo de enchufe y las ubicaciones del conector pueden variar / Steckertyp und Position der Anschlüsse können abweichen / Il tipo di spina e le posizioni del connettore possono variare.

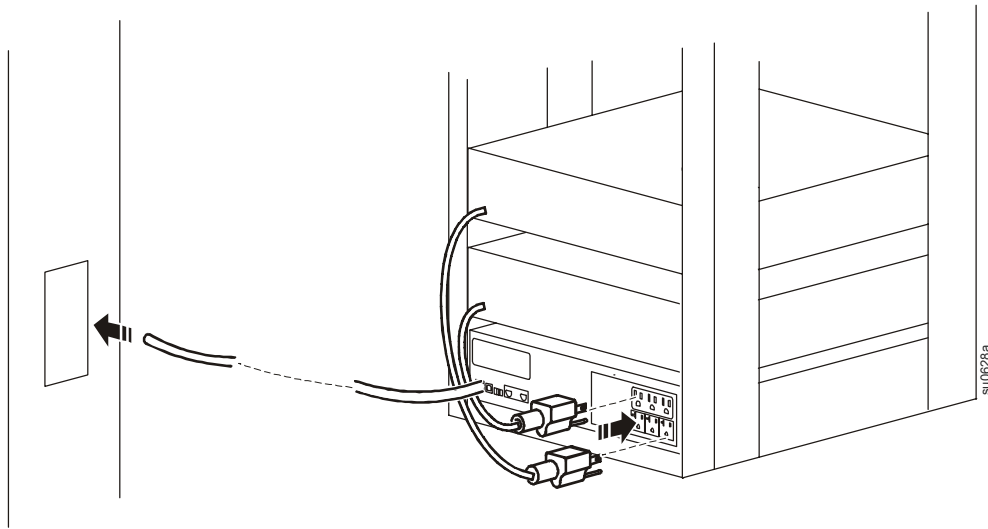

## Display Interface / Interface d'affichage / Interfaz de pantalla / Anzeige / Interfaccia del display

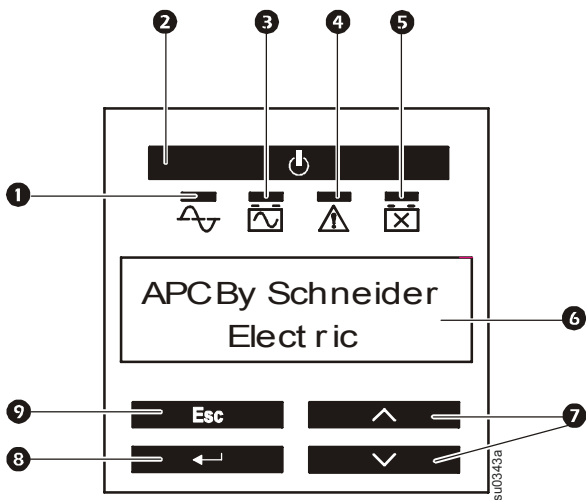

- ❶ Online indicator / Voyant En ligne / Indicador en línea / Betriebsanzeige / Indicatore in linea
- ❷ UPS output On/Off / Sortie de l'onduleur activée / désactivée / Encendido/apagado de la salida del SAI / USV-Ausgang ein/aus / Attivazione/disattivazione uscita dell'UPS
- ❸ On Battery indicator / Voyant Sur batterie / Indicador de funcionamiento con batería / Batteriebetriebsanzeige / Indicatore di alimentazione a batteria
- ❹ Fault indicator / Indicateur de panne / Indicador de fallo / Fehleranzeige / Indicatore di errori
- ❺ Replace Battery indicator / Voyant Remplacer la batterie / Indicador de reemplazo de batería / Anzeige „Batterie austauschen“ / Indicatore di sostituzione della batteria
- ❻ Display screen / Ecran d'affichage / Pantalla / Anzeigebildschirm / Display
- ❼ UP/DOWN arrow keys / Flèches HAUT/BAS / Teclas de dirección ARRIBA / ABAJO / AUF-/ABWÄRTS-Pfeiltasten / Tasti frecce SU/GIÙ
- ❽ ENTER key / Touche ENTREE / Tecla INTRO / EINGABE-Taste / Tasto INVIO
- ❾ ESC key / Touche ESC (Echap) / Tecla ESC / ESC-Taste / Tasto ESC

## **Controllable outlet groups / Groupe de sorties contrôlées / Grupos de tomacorrientes controlables / Steuerbare Ausgangsgruppen / Gruppi di prese controllabili**

Some UPS models have one bank of outlets that can function as a controlled group. Use the display interface to configure the controllable outlet features, navigate to: **Main Menu > Control > Outlet1 Control** / Certains onduleurs sont équipés d'un groupe de sorties pouvant servir de groupe contrôlé. L'interface d'affichage permet de configurer les sorties contrôlées : **Main Menu (Menu principal) > Control (Contrôle) > Outlet1 Control (Contrôle de la sortie 1)** / Algunos modelos de SAI tienen un banco de tomacorrientes que puede funcionar como un grupo controlable. Use la interfaz de pantalla para configurar las funciones de tomacorrientes controlables, seleccione: **Main Menu > Control > Outlet1 Control (Menú principal > Control > Control Tomacorrientes1)** / Bestimmte USV-Modelle verfügen über eine Reihe Ausgänge, die als gesteuerte Gruppe verwendet werden können. Navigieren Sie zu: **Main Menu > Control > Outlet1 Control (Hauptmenü > Steuerung > Ausgang1 Steuerung)**, um die Einstellungen für die gesteuerten Ausgänge zu konfigurieren. / Alcuni modelli di UPS dispongono di una fila di prese che possono funzionare come un gruppo controllato. Per utilizzare l'interfaccia del display e configurare le funzionalità delle uscite controllabili, selezionare: **Main Menu (Menu principale) > Control (Controllo) > Outlet1 Control (Controllo prese 1)**.





## Free Manuals Download Website

<http://myh66.com>

<http://usermanuals.us>

<http://www.somanuals.com>

<http://www.4manuals.cc>

<http://www.manual-lib.com>

<http://www.404manual.com>

<http://www.luxmanual.com>

<http://aubethermostatmanual.com>

Golf course search by state

<http://golfingnear.com>

Email search by domain

<http://emailbydomain.com>

Auto manuals search

<http://auto.somanuals.com>

TV manuals search

<http://tv.somanuals.com>