

ZERO *ARF*

INSTRUCTION MANUAL

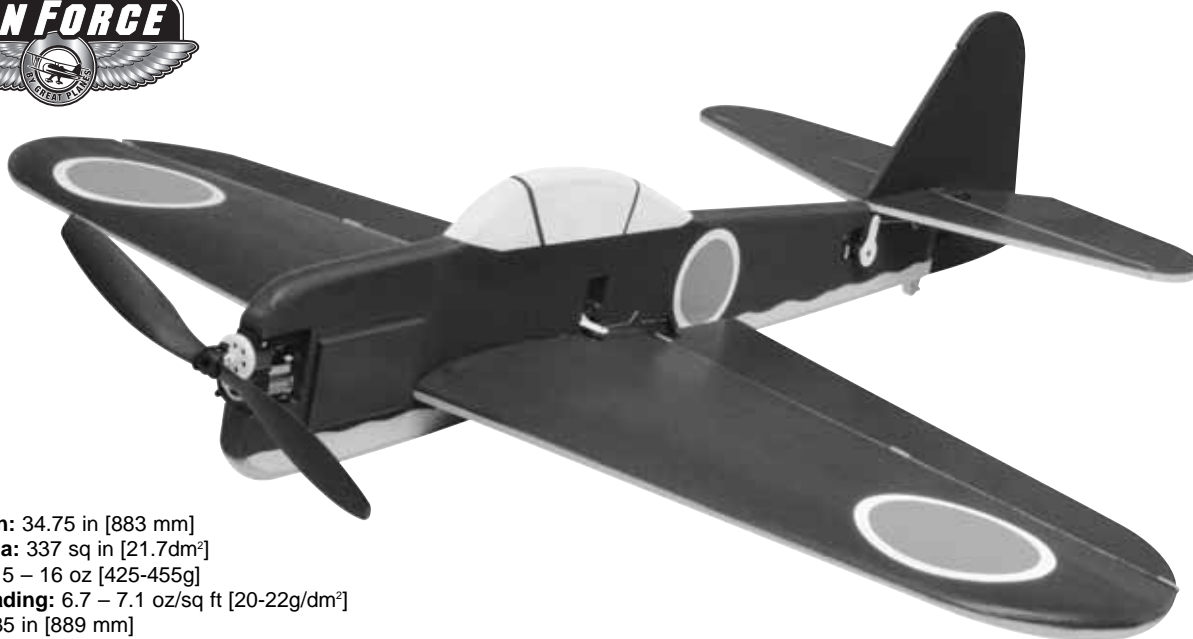

Wingspan: 34.75 in [883 mm]
Wing Area: 337 sq in [21.7dm²]
Weight: 15 – 16 oz [425-455g]
Wing Loading: 6.7 – 7.1 oz/sq ft [20-22g/dm²]
Length: 35 in [889 mm]
Radio: 4-channel w/ three micro servos and 20 Amp ESC
Motor: Supplied S380 Motor w/ 5:1 gearbox

WARRANTY

Great Planes® Model Manufacturing Co. guarantees this kit to be free from defects in both material and workmanship at the date of purchase. This warranty does not cover any component parts damaged by use or modification. **In no case shall Great Planes' liability exceed the original cost of the purchased kit.** Further, Great Planes reserves the right to change or modify this warranty without notice.

In that Great Planes has no control over the final assembly or material used for final assembly, no liability shall be assumed nor accepted for any damage resulting from the use by the user of the final user-assembled product. By the act of using the user-assembled product, the user accepts all resulting liability.

If the buyer is not prepared to accept the liability associated with the use of this product, the buyer is advised to return this kit immediately in new and unused condition to the place of purchase.

To make a warranty claim send the defective part or item to Hobby Services at the address below:

Hobby Services
3002 N. Apollo Dr., Suite 1
Champaign, IL 61822
USA

Include a letter stating your name, return shipping address, as much contact information as possible (daytime telephone number, fax number, e-mail address), a detailed description of the problem and a photocopy of the purchase receipt. Upon receipt of the package the problem will be evaluated as quickly as possible.

READ THROUGH THIS MANUAL BEFORE STARTING CONSTRUCTION. IT CONTAINS IMPORTANT INSTRUCTIONS AND WARNINGS CONCERNING THE ASSEMBLY AND USE OF THIS MODEL.



Champaign, Illinois
(217) 398-8970, Ext 5
airsupport@greatplanes.com

TABLE OF CONTENTS

INTRODUCTION	2
AMA	2
SAFETY PRECAUTIONS	3
LITHIUM BATTERY HANDLING & USAGE	3
DECISIONS YOU MUST MAKE	3
Transmitter	3
Servos	3
Receiver	4
Battery	4
Speed Control	4
Charger	4
Battery Charging Leads	4
Glue	4
ADDITIONAL ITEMS REQUIRED	4
Radio Equipment	4
Adhesives & Building Supplies	4
Optional Supplies & Tools	5
IMPORTANT BUILDING NOTES	5
ORDERING REPLACEMENT PARTS	5
METRIC CONVERSIONS	5
KIT INSPECTION	6
KIT CONTENTS	6
BUILDING INSTRUCTIONS	7
Join the Wing Halves	7
Join the Wing to the Fuselage	7
Install the Tail Surfaces	8
Hinge the Ailerons	8
Install the Servos	9
Install the Control Horns and Pushrods	10
Install the Motor & Speed Control	11
Final Setup	12
Optional Combat Setup	13
GET THE MODEL READY TO FLY	13
Check the Control Directions	13
Set the Control Throws	13
Balance the Model (C.G.)	14
Balance the Model Laterally	14
PREFLIGHT	15
Identify Your Model	15
Charge the Batteries	15
Balance the Propellers	15
Ground Check	15
Range Check	15
MOTOR SAFETY PRECAUTIONS	15
AMA SAFETY CODE (excerpts)	16
General	16
Radio Control	16
CHECK LIST	16
FLYING	16
Launch	17
Flight	17
Landing	17

INTRODUCTION

The Great Planes Fun Force™ EP Zero ARF is an excellent way to enjoy 3D aerobatics and combat dogfighting without the cost and headaches of larger, high-powered models. A couple of hours on the workbench, and your EP Zero ARF will be ready for sport aerobatics and some mild 3D-type maneuvers, and more! If you tire of aerobatics, strap a streamer onto the supplied combat mount and experience the thrill of close-in combat dogfighting. With two or more of the Fun Force series combat aircraft, you can recreate classic dogfights of history!

For the latest technical updates or manual corrections to the EP Zero ARF, visit the Great Planes web site at www.greatplanes.com. Open the "Airplanes" link, and then select the EP Zero ARF. If there is new technical information or changes to this model a "tech notice" box will appear in the upper left corner of the page.

AMA

We urge you to join the **AMA** (Academy of Model Aeronautics) and a local R/C club. The AMA is the governing body of model aviation and membership is required to fly at AMA clubs. Though joining the AMA provides many benefits, one of the primary reasons to join is liability protection. Coverage is not limited to flying at contests or on the club field. It even applies to flying at public demonstrations and air shows. Failure to comply with the Safety Code (excerpts printed in the back of the manual) may endanger insurance coverage. Additionally, training programs and instructors are available at AMA club sites to help you get started the right way. There are over 2,500 AMA chartered clubs across the country. Contact the AMA at the address or toll-free phone number below.



Academy of Model Aeronautics

5151 East Memorial Drive

Muncie, IN 47302

Tele: (800) 435-9262

Fax (765) 741-0057

Or via the Internet at:

<http://www.modelaircraft.org>

IMPORTANT!!! Two of the most important things you can do to preserve the radio controlled aircraft hobby are to avoid flying near full-scale aircraft and avoid flying near or over groups of people.

PROTECT YOUR MODEL, YOURSELF & OTHERS...FOLLOW THESE IMPORTANT SAFETY PRECAUTIONS

1. Your EP Zero ARF should not be considered a toy, but rather a sophisticated, working model that functions very much like a full-size airplane. Because of its performance capabilities, the EP Zero ARF, if not assembled and operated correctly, could possibly cause injury to yourself or spectators and damage to property.

2. You must assemble the model **according to the instructions**. Do not alter or modify the model, as doing so may result in an unsafe or unflyable model. In a few cases the instructions may differ slightly from the photos. In those instances the written instructions should be considered as correct.

3. You must take time to **build straight, true and strong**.

4. You must use an R/C radio system that is in first-class condition, and a correctly sized motor and components (ESC, wheels, etc.) throughout the building process.

5. You must correctly install all R/C and other components so that the model operates correctly on the ground and in the air.

6. You must check the operation of the model before **every** flight to insure that all equipment is operating and that the model has remained structurally sound. Be sure to check clevises or other connectors often and replace them if they show any signs of wear or fatigue.

7. If you are not an experienced pilot or have not flown this type of model before, we recommend that you get the assistance of an experienced pilot in your R/C club for your first flights. If you're not a member of a club, your local hobby shop has information about clubs in your area whose membership includes experienced pilots.

8. While this kit has been flight tested to exceed normal use, if the plane will be used for extremely high-stress flying, such as racing, or if an motor larger than one in the recommended range is used, the modeler is responsible for taking steps to reinforce the high-stress points and/or substituting hardware more suitable for the increased stress.

We, as the kit manufacturer, provide you with a top quality, thoroughly tested kit and instructions, but ultimately the quality and flyability of your finished model depends on how you build it; therefore, we cannot in any way guarantee the performance of your completed model, and no representations are expressed or implied as to the performance or safety of your completed model.

Remember: Take your time and follow the instructions to end up with a well-built model that is straight and true.

LITHIUM BATTERY HANDLING & USAGE

WARNING!! Failure to follow all instructions could cause permanent damage to the battery and its surroundings, and cause bodily harm!

- ONLY use a LiPo approved charger. NEVER use a NiCd/NiMH peak charger!
- NEVER charge in excess of 4.20V per cell.
- ONLY charge through the "charge" lead. NEVER charge through the "discharge" lead.
- NEVER charge at currents greater than 1C.
- ALWAYS set charger's output volts to match battery volts.
- ALWAYS charge in a fireproof location.
- NEVER trickle charge.
- NEVER allow the battery temperature to exceed 50°F (65°C).
- NEVER disassemble or modify pack wiring in any way or puncture cells.
- NEVER discharge below 2.5V per cell.
- NEVER place on combustible materials or leave unattended during charge or discharge.
- ALWAYS KEEP OUT OF REACH OF CHILDREN.

DECISIONS YOU MUST MAKE

In the hands of a capable pilot the EP Zero ARF is an impressive 3D performer. But for the EP Zero ARF to perform to its full potential, it must be properly equipped with all the right gear (servos, batteries, receiver, and speed control). There may be more than one type and brand of radio equipment that can be used, but based on extensive testing, following is the equipment we recommend so you can get the most performance out of your EP Zero ARF and assemble it as shown in this instruction manual.

Transmitter

With a standard, four-channel radio the EP Zero ARF is capable of all the basic 3D maneuvers. However, some advanced pilots who are already familiar with handling "foamies" may prefer to fly the EP Zero ARF with a computer radio capable of endpoint adjustments (for fine-tuning control throws), exponentials (for "softening" the throws near the center of the travel), and various mixing functions (such as rudder-to-elevator mixing for extended knife-edge flight).

Servos

The EP Zero ARF requires three *micro* servos with a minimum torque rating of 15 oz-in. Futaba® S-3108 micro servos (FUTM0042) are ideal because they meet the torque and weight requirements. Although there may be other servos that will physically fit in the model, those outside the recommended

weight and torque specifications will adversely affect flight performance and are not recommended. **Note:** During assembly when it's time to mount the servos, you will be instructed to glue them in. Do not be alarmed as this is a common practice with this type of lightweight, high-performance model. Should servo removal ever be necessary for repair, replacement or transfer to another model this can be done by prying them out with a hobby knife or a small screwdriver.

Receiver

The lightest, four-channel receiver is recommended and must be compatible with whatever servos will be used (not all servos are compatible with all receivers—even servos and receivers within the same brand). The Futaba R-114F *Micro* receiver is recommended and is compatible with the 3108 servos recommended. **Note:** Futaba receivers are sold on high and low bands and come without crystals. Following are the order numbers for the R-114F receiver and compatible crystals:

	Low Band (Channels 11-35)	High Band (Channels 36-60)
R114F Receiver	FUTL0442	FUTL0443
Crystal	FUTL62**	FUTL63**

Replace the “” in the order number for the crystals with the preferred channel number. For example, if you want to fly on channel 33, order a low band receiver and crystal number FUTL6233.

Battery

The EP Zero ARF requires a 3-cell (11.1V), 1250–1500mAh lithium-polymer (LiPo) battery capable of providing 7A continuous discharge current. The ElectriFly™ 3-cell, *3-Series* 1250mAh battery pack is recommended (GPMP0823).

Speed Control

An electronic speed control capable of handling a minimum of 15A continuous current is required. Additionally, the speed control should be as light as possible. The ElectriFly C-25 High-Frequency ESC w/BEC (GPMM2025) is suitable.

Charger

A charger capable of charging 3-cell (11.1V) LiPo batteries such as the ElectriFly PolyCharge 1 to 3-cell LiPo charger (GPMM3010) must be used. If using another charger, it **must** be a LiPo charger or have a LiPo charge mode. Never charge LiPo batteries with chargers not intended for LiPo batteries or chargers on NiMH or NiCd settings. Overcharging or explosion may result. In addition to the PolyCharge, the ElectriFly Triton™ (GPMM3150) or Accu-Cycle Elite™ (HCAP0280) are also suitable chargers.

Battery Charging Leads

Many chargers (including the Triton and Accu-Cycle Elite listed above) do not include charging leads, but rather have banana jacks to plug the leads into. If this is the case with your charger, you will need to purchase a charge lead to match your battery.

Glue

Although it is safe to use foam-safe CA, it is not recommended for assembly of the main fuselage components as it may wrinkle the lightweight covering and cause the covering to come loose from the foam. Therefore, epoxy should be used throughout the building process unless foam-safe CA is recommended for a particular step.

ADDITIONAL ITEMS REQUIRED

Radio Equipment

To complete the EP Zero ARF you will need the following.

- 4-channel radio with (3) micro servos (0.3 oz [9g] or less each) (FUTM0042)
- Micro receiver (FUTL0442 low band or FUTM0443 high band)
- One 6" [153 mm] servo extension (HCAM2000)
- One 12" [305 mm] servo extension (HCAM2100)
- 25 Amp brushed ESC (GPMM2025)
- 3-cell LiPo or Li-Ion battery pack, 1500mAh (GPMP0831), 640mAh (GPMP0805), or 1250mAh (GPMP0823)
- Hobbico® Accu-Cycle Elite charger (HCAP0280)
- Lithium-Polymer Charger (GPMP3150, GPMP3010)

Adhesives & Building Supplies

This is the list of Adhesives and Building Supplies that are required to finish the EP Zero ARF.

- Great Planes Pro™ 6-minute epoxy (GPMR6042)
- Great Planes Pro foam-safe CA (GPMR6072)
- 60/40 Tin/lead solder
- Soldering iron
- Hobby knife with #11 blade
- 1/8" [3.2 mm] Drill bit

Optional Supplies & Tools

Here is a list of optional tools mentioned in the manual that will help you build the EP Zero ARF.

- Great Planes C.G. Machine™ (GPMR2400)
- Clear packing tape

IMPORTANT BUILDING NOTES

- When you see the term **test fit** in the instructions, it means that you should first position the part on the assembly **without using any glue** and then slightly modify or *custom fit* the part as necessary for the best fit.
- Whenever the term **glue** is written you should rely upon your experience to decide what type of glue to use. When a specific type of adhesive works best for that step, the instructions will make a recommendation. Since this model is constructed from foam, we recommend the use of foam-safe CA glues and epoxy only. **Do not use standard CA glue on this model as it will dissolve the structure.**
- Whenever just **epoxy** is specified, you may use **either** 30-minute (or 45-minute) epoxy **or** 6-minute epoxy. When 30-minute epoxy is specified it is **highly** recommended that you use only 30-minute (or 45-minute) epoxy, because you will need the working time and/or the additional strength.
- **Photos** and **sketches** are placed **before** the step they refer to. Frequently you can study photos in following steps to get another view of the same parts.

ORDERING REPLACEMENT PARTS

Replacement parts for the Great Planes EP Zero ARF are available using the order numbers in the **Replacement Parts List** that follows. The fastest, most economical service can be provided by your hobby dealer or mail-order company.

To locate a hobby dealer, visit the Hobbico web site at www.hobbico.com. Choose "Where to Buy" at the bottom of the menu on the left side of the page. Follow the instructions provided on the page to locate a U.S., Canadian or International dealer. If a hobby shop is not available, replacement parts may also be ordered from Tower Hobbies® at www.towerhobbies.com, or by calling toll free (800) 637-6050.

Parts may also be ordered directly from Hobby Services by calling (217) 398-0007, or via facsimile at (217) 398-7721, but full retail prices and shipping and handling charges will apply. Illinois and Nevada residents will also be charged sales tax. If ordering via fax, include a Visa® or MasterCard® number and expiration date for payment.

Mail parts orders and payments by personal check to:

Hobby Services
3002 N. Apollo Drive, Suite 1
Champaign, IL 61822

Be certain to specify the order number exactly as listed in the **Replacement Parts List**. Payment by credit card or personal check only; no C.O.D.

If additional assistance is required for any reason contact Product Support by e-mail at productsupport@greatplanes.com, or by telephone at (217) 398-8970.

Replacement Parts List

Order Number	Description	How to Purchase
	Missing pieces	Contact Product Support
	Instruction manual	Contact Product Support
	Full-size plans	Not available
GPMG0215	Gear Drive	Contact Hobby Supplier
GPMG0860	Replacement Shaft with Spur Gear	Contact Hobby Supplier
GPMG0311	Replacement Motor	Contact Hobby Supplier
GPMQ1682	10x4.5 Propeller	Contact Hobby Supplier
GPMQ4620	Prop Saver	Contact Hobby Supplier
GPMA2792	Hardware Bag	Contact Hobby Supplier
GPMG0216	Motor/Gear Drive Assembly	Contact Hobby Supplier
GPMQ4619	Prop Saver Rubber Bands	Contact Hobby Supplier

METRIC CONVERSIONS

1" = 25.4 mm (conversion factor)

1/64"	=	.4 mm	3/4"	=	19.0 mm
1/32"	=	.8 mm	1"	=	25.4 mm
1/16"	=	1.6 mm	2"	=	50.8 mm
3/32"	=	2.4 mm	3"	=	76.2 mm
1/8"	=	3.2 mm	6"	=	152.4 mm
5/32"	=	4.0 mm	12"	=	304.8 mm
3/16"	=	4.8 mm	18"	=	457.2 mm
1/4"	=	6.4 mm	21"	=	533.4 mm
3/8"	=	9.5 mm	24"	=	609.6 mm
1/2"	=	12.7 mm	30"	=	762.0 mm
5/8"	=	15.9 mm	36"	=	914.4 mm

KIT INSPECTION

Before starting to build, take an inventory of this kit to make sure it is complete, and inspect the parts to make sure they are of acceptable quality. If any parts are missing or are not of acceptable quality, or if you need assistance with assembly, contact **Product Support**. When reporting defective or missing parts, use the part names exactly as they are written in the Kit Contents list.

Great Planes Product Support
3002 N. Apollo Drive, Suite 1
Champaign, IL 61822
Telephone: (217) 398-8970, ext. 5
Fax: (217) 398-7721
E-mail: airsupport@greatplanes.com

KIT CONTENTS

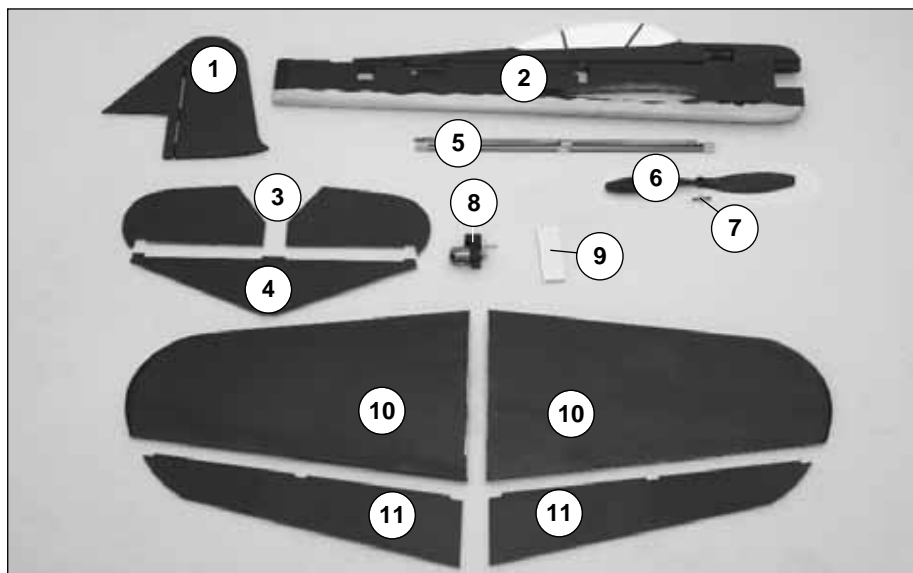

Kit Contents

Kit Contents Photographed

1. Fin & Rudder
2. Fuselage
3. Elevator Halves (L&R)
4. Horizontal Stabilizer
5. Pushrods & Carbon Rods
6. Propeller
7. Prop Saver
8. Motor/Gearbox Assembly
9. Hook & Loop Material
10. Wing Halves (L&R)
11. Ailerons (L&R)

Kit Contents (Not Photographed)

Streamer Bag
Pushrod Bag

Hardware Bag (includes)

Single Servo Arm Extenders (2)
Double Servo Arm Extender (1)
Snap Keepers (4)
Black Control Horns w/ Backplates (4)

BUILDING INSTRUCTIONS

Note: This model is covered with a very thin layer of film which is then painted with a special lightweight paint to conserve weight. Avoid the use of tape to help position the fuselage components during assembly. Also, **Do Not** attempt to remove any of the trim markings as this will damage the painted surface beneath.

Also, for simplicity, all of the carbon rods in this ARF are of the same diameter. When identifying the rods for the corresponding step, only the lengths are mentioned.

Join the Wing Halves

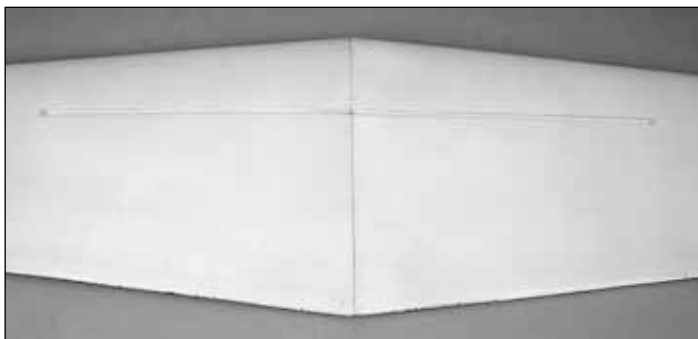

1. Using epoxy, join the two **wing halves** together, making sure to align the root sections.

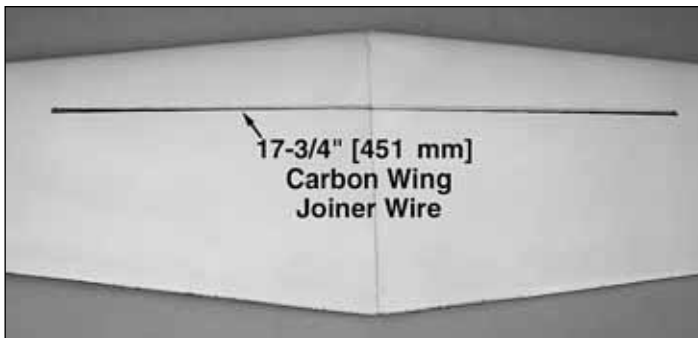

2. Epoxy the 17-3/4" [451 mm] carbon **wing joiner tube** into the slot on the bottom of the wing. Make sure it is fully seated in the slot.

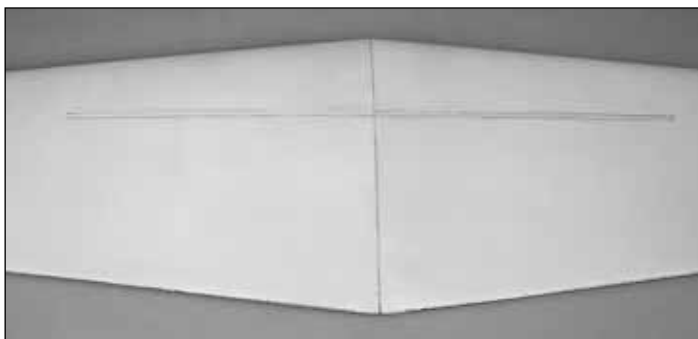

3. Epoxy the foam inserts into the wing slot over the carbon joiner. Make sure they are fully seated against the joiner. The foam inserts may not be completely flush with the bottom of the wing.

Join the Wing to the Fuselage

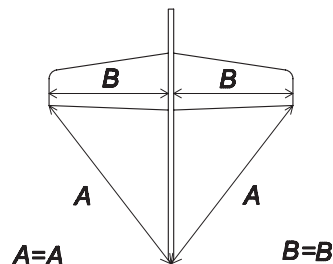

1. Insert the wing into the fuselage. Be sure that the wing is centered and square by making sure all measurements are equal as shown in the sketch.

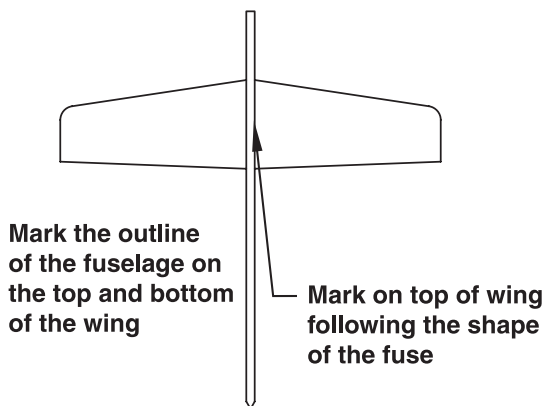

2. Trace along the fuselage sides on the top and bottom of the wing with a felt-tip pen or a pencil.

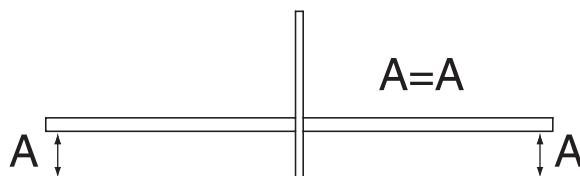
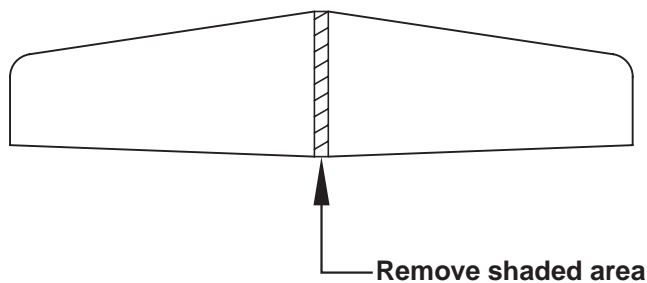

3. Slide the wing out just enough to see the entire area covered by the fuselage. Remove the covering from the wing using a hobby knife 3/32" [2 mm] inside the marks you made. Apply a thin layer of epoxy and slide the wing into place. Use the marks from the previous step to align the wing. Clean up any excess glue with a paper towel. **DO NOT** use alcohol or any other solvent for cleanup as the paint finish will be affected.

Install the Tail Surfaces

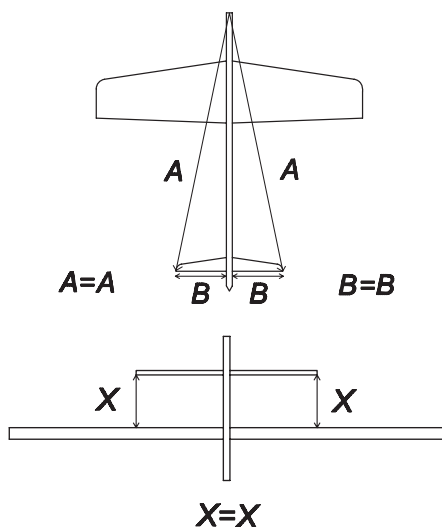
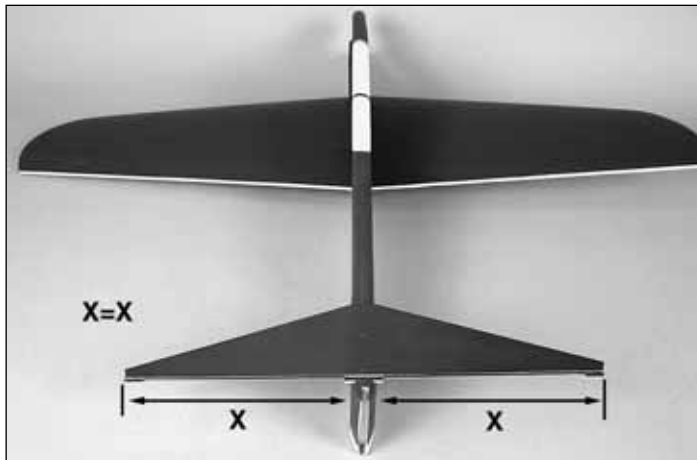

- ❑ 1. Slide the stab into the slot in the rear of the fuselage. Center it as you did with the wing. Make sure the measurements shown in the sketches are equal. Glue the stab in place when satisfied with the fit.

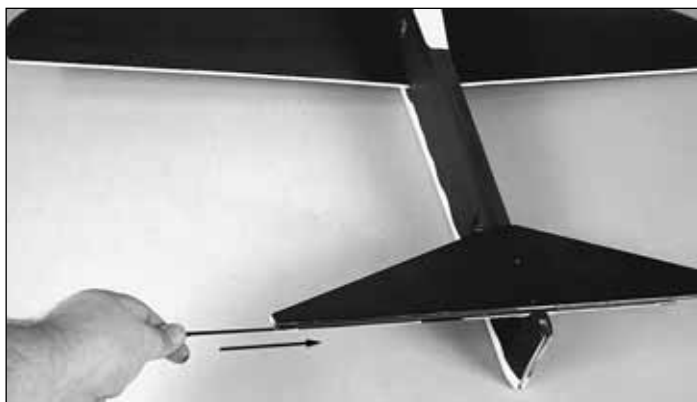

- ❑ 2. Locate the 13.5" [343 mm] carbon **elevator rod**. Insert this rod into the preinstalled plastic bearings on the stab. DO NOT glue in place.



- ❑ 3. Use foam-safe CA to glue one of the **elevator halves** to the carbon elevator rod. Then glue the other elevator to the carbon elevator rod. Be sure the two halves are even as shown.

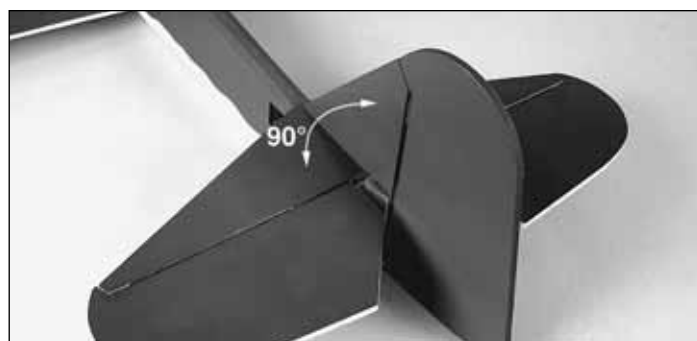
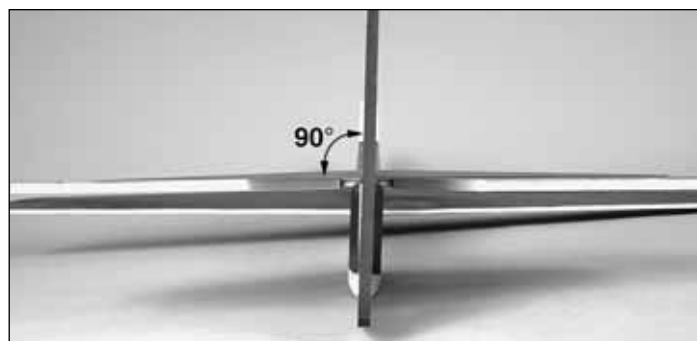

- ❑ 4. Glue the fin and rudder to the fuselage with epoxy. Make sure that the fin remains perpendicular to the stab and centered on the fuselage.

Hinge the Ailerons



- ❑ ❑ 1. Locate one of the carbon **wing hinge assemblies**. One of the carbon tubes is glued to the bearings; the other is free to rotate. Remove the loose carbon rod to prevent accidental gluing in the next steps.

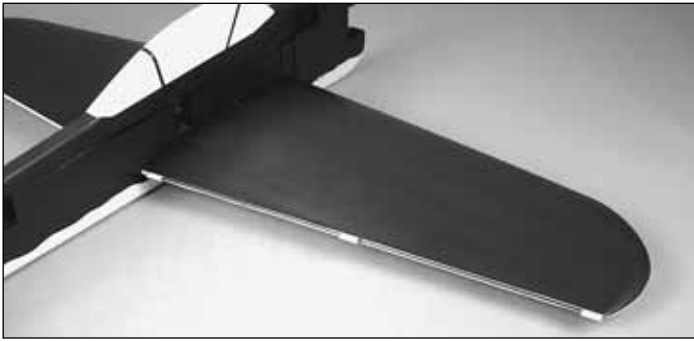

2. Test fit one of the wing hinges in the wing. The outer bearing should be flush with the wing tip. When satisfied with the fit, epoxy the hinge in place. Be careful to avoid getting epoxy into the open bearings.

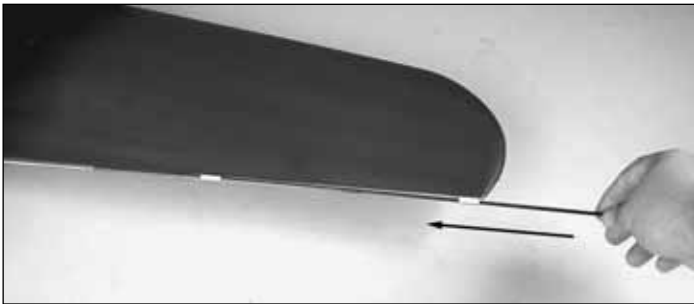

3. Slide the loose carbon rod through the bearings.



4. Test fit an aileron onto the carbon rod as shown. If satisfied with the fit, glue the aileron to the carbon rod using CA. DO NOT glue the aileron to the bearings. The rod must freely rotate in the bearings, so the aileron must only be glued to the carbon rod.

Install the Servos

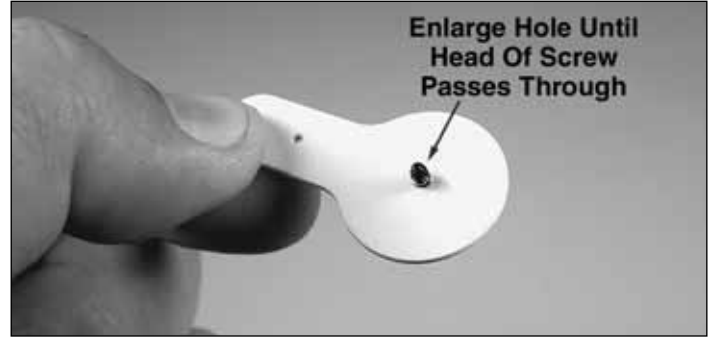

1. Remove the screws and servo arms from all of your servos. Enlarge the hole in the center of the extender until the head of the servo screw fits through.

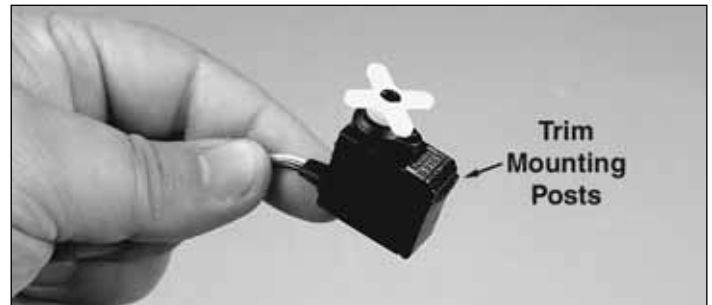

2. Trim the mounting posts off of the servo as shown in the photo.

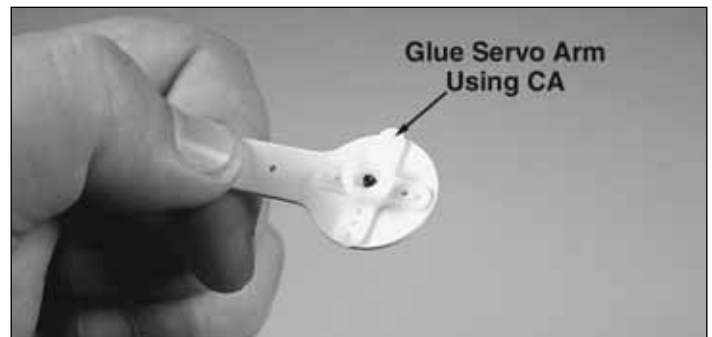
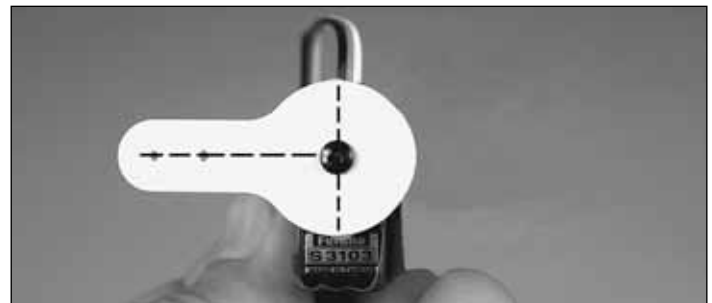

3. Place the original servo arm over the screw, and glue the top of the arm to the extender with CA. Some servo arms have small flanges projecting from the top. If your servo arms have these flanges, sand them off before gluing.

Install the Control Horns & Pushrods

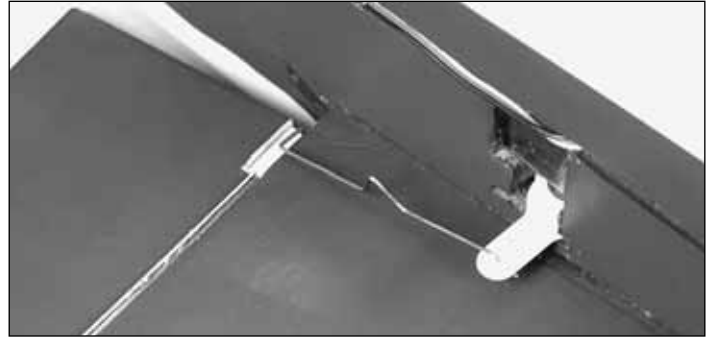

1. Locate the two 2-3/4" [70 mm] prebent **aileron pushrods**. Slightly enlarge the outer hole on the aileron servo arm. Insert the Z-bend end of the pushrods into the outer hole on the aileron servo arm.

2. Center your aileron servo to ensure it is at neutral. Use a small clamp or some masking tape to hold the aileron at neutral. Align the pushrods straight back towards the ailerons.

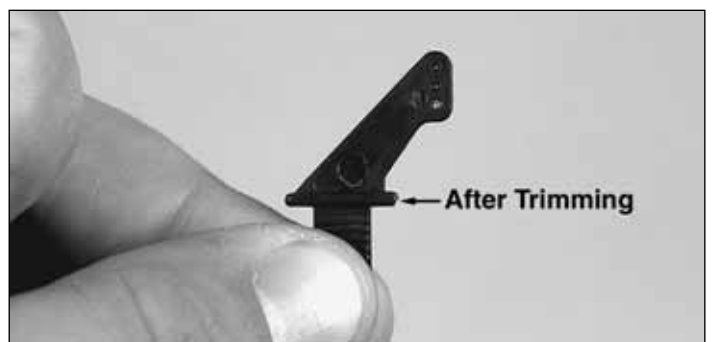
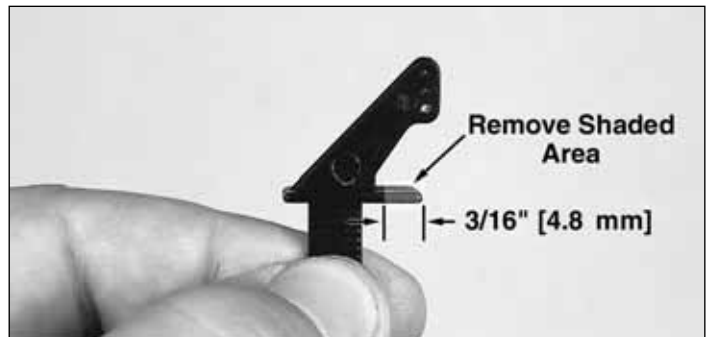

3. Locate a black nylon **control horn**. Trim the small plastic section away as shown.

4. Make a small 1/4" [6.4 mm] long cut in the aileron behind the bearing. Insert the 90° bend of the pushrod into the middle hole of one of the black nylon control horns.

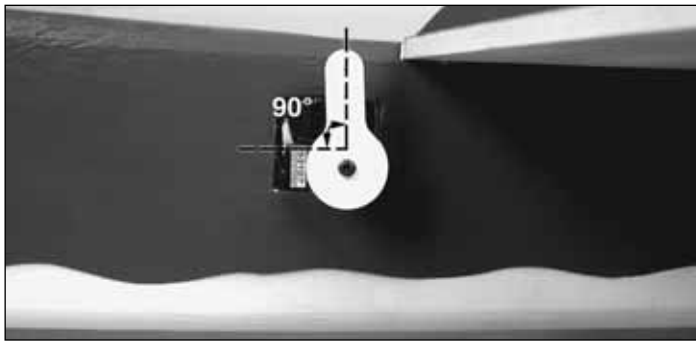

4. Epoxy a servo into the bottom of the rear servo cutout from the left side of the plane. The output shaft should be toward the front of the fuselage. Center the servo with your radio and screw the extended arm onto the output shaft with the arm oriented straight up.

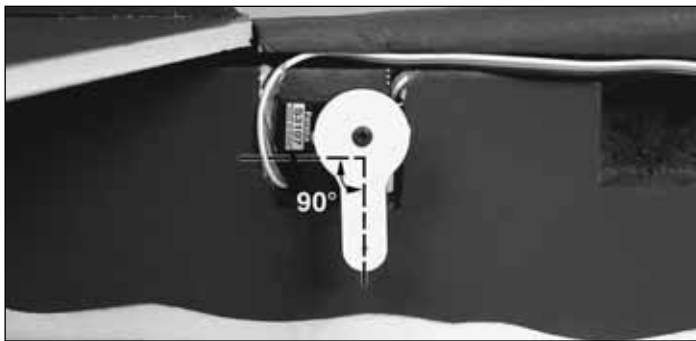

5. Epoxy the other tail servo into the cutout from the right side of the plane side with the output shaft toward the front. Center the servo with your radio and screw the extended arm onto the output shaft with the arm oriented straight down.

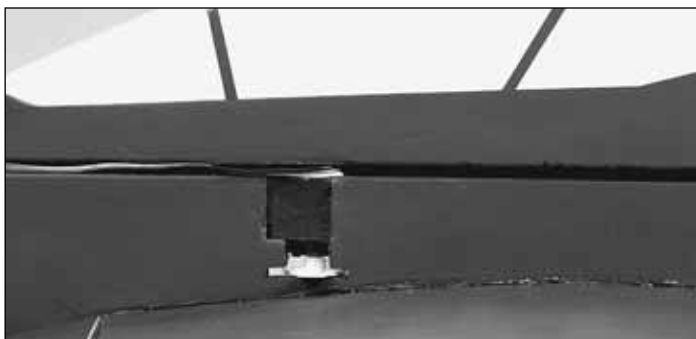
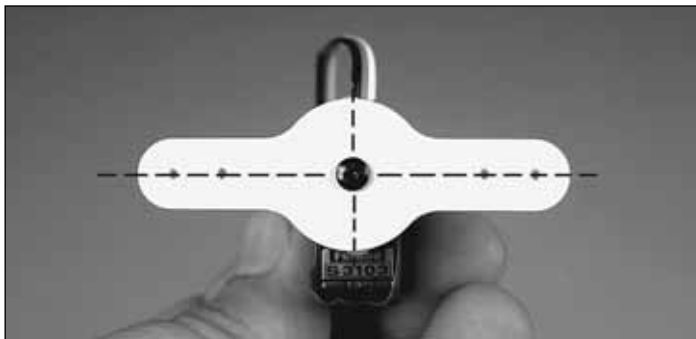

6. Center your aileron servo with your radio and screw the extended double-sided arm onto the servo. When you glue the extended servo arm, be sure it is exactly centered as shown. Epoxy the aileron servo into the cutout in the fuselage.

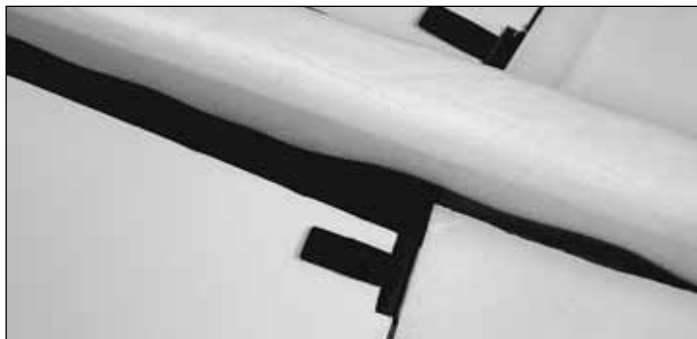
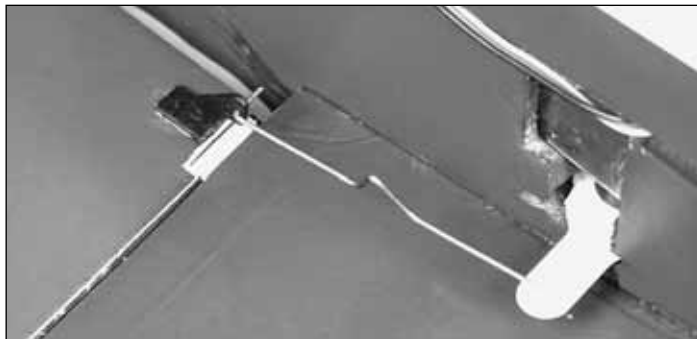

□ □ 5. Apply a small spot of foam-safe CA to the bottom of the control horn and insert it into the cut in the aileron. Press a nylon **backplate** on the backside of the control horn as shown.

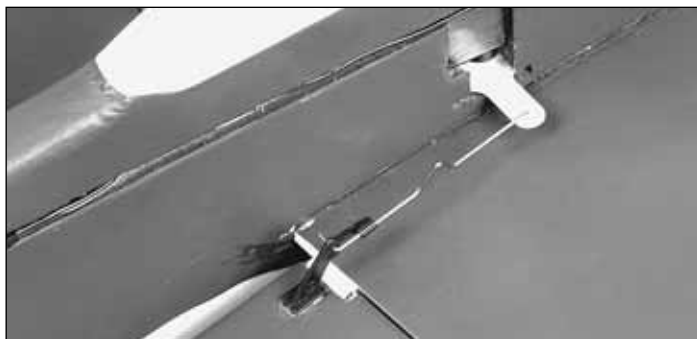

□ □ 6. Install a black nylon **snap keeper** onto the pushrod at the control horn.

□ 7. Install the **rudder** and **elevator pushrods** in the same way as the ailerons. Use the 5-3/4" [146 mm] prebent pushrod for the rudder and the 2-1/2" [64 mm] prebent pushrod for the elevator.

Install the Motor & Speed Control

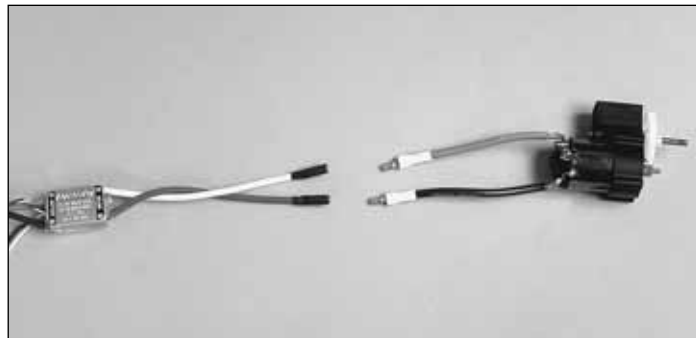

□ 1. Connect the output wires of your ESC to the motor. Check the direction of the motor before permanently installing it.



□ 2. Install the ESC as shown using a small section of hook and loop tape. Place the hard "hook" side in the provided cutout in the fuselage and the softer "loop" side on the back of the ESC. If your ESC has a BEC switch, install it in the provided cutout. For some electronic speed controls, it may be necessary to trim the foam slightly to allow for wire clearance and switch mounting.

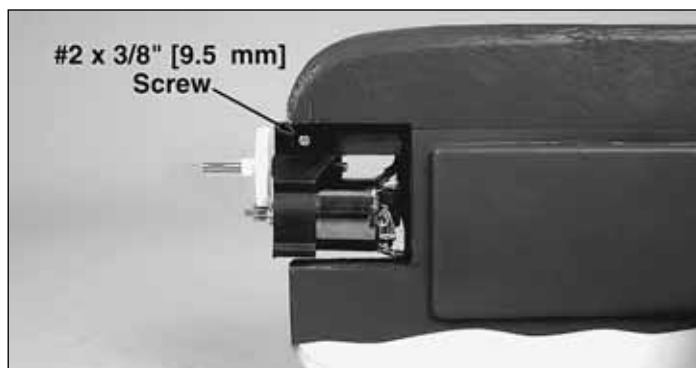

□ 3. Slide the gearbox onto the square **wood stick** in the nose. Secure it with the supplied #2 x 3/8" [9.5 mm] **screw**.

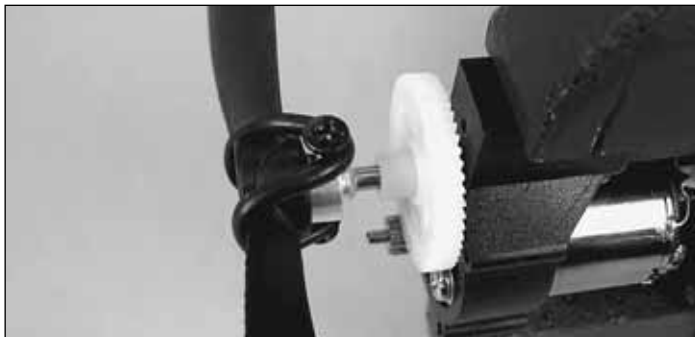
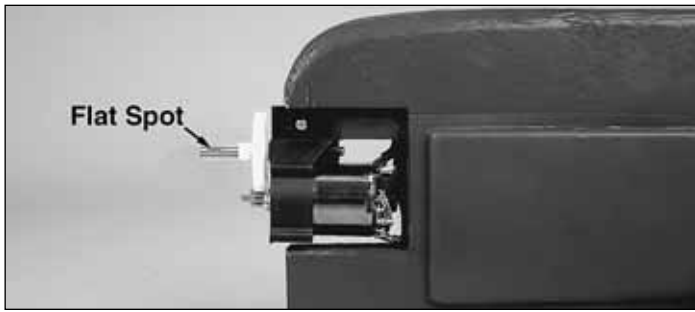

❑ 4. Install the prop saver onto the gearbox output shaft. The screws should seat down into the flat spots on the shaft. Add a drop of thread-lock and be sure the screws are tightened to prevent them from backing out during operation. **Note:** The prop saver has two different diameters. Match the size of your prop hub to the prop saver before installing the prop to the gearbox. Attach the prop using the supplied black O-ring.

Final Setup



❑ 1. Attach the **receiver** to the cutout in the rear of the fuselage using a small section of the supplied **hook and loop tape**. Place the rough, or “hook” side of the tape into the cutout in the fuselage and the soft “loop” side of the tape on the back of the receiver.

❑ 2. Connect the servos and ESC to their channels on the receiver. You will need to use extensions to allow the aileron servo and ESC leads to reach the receiver. Use a 6" [153 mm] **extension** for the aileron servo lead, and a 12" [305 mm] **extension** for the ESC. Route the servo leads through the pre-cut channels in the fuselage to reach the receiver. Hold them in place by applying clear tape (not included) over the openings.

❑ 3. Power up your radio system and center the servos. If necessary, adjust the center point of the control surfaces by tightening or enlarging the V-bend in each pushrod.

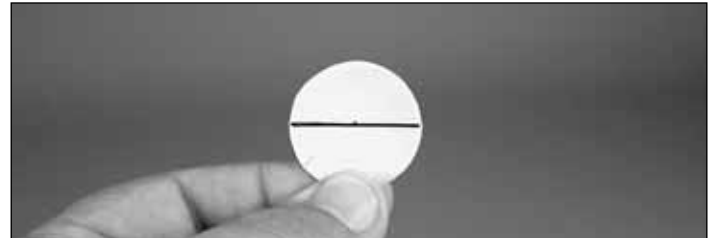

❑ 4. Locate the 1" [25 mm] plastic streamer mount. Mark the approximate midpoint of the mount.

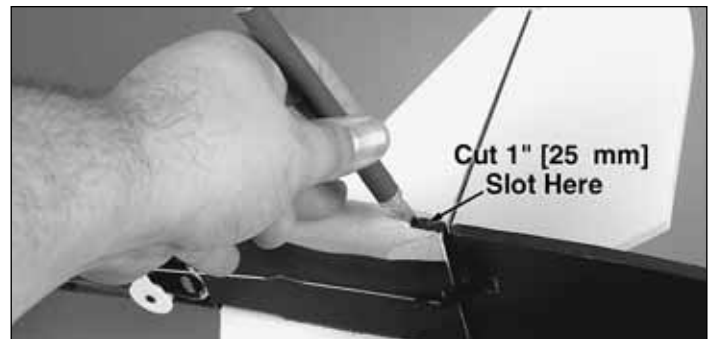

❑ 5. Cut a 1" [25 mm] slot in the bottom of the fuselage at the tail as shown. The exact location is not important; it simply needs to be at the tail of the fuselage. Do not attach the mount to the rudder control surface.

❑ 6. Test fit the mount in the groove. It should insert up to the midpoint line. Glue in place using epoxy.

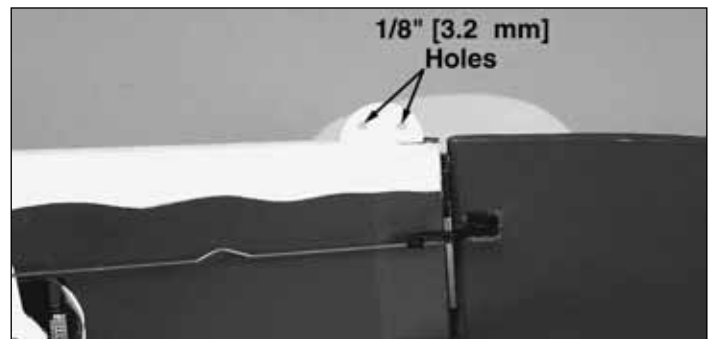

❑ 7. Drill two 1/8" [3.2 mm] holes in the mount. If not flying combat, use the two holes to route the antenna from the receiver.

Optional Combat Setup

The EP Zero ARF was designed with the intention that two or more of these easily built, fun to fly models could be outfitted with streamers and used for combat. If you intend to fly combat with this model, you will need to attach the optional **streamer mount** using the instructions below.

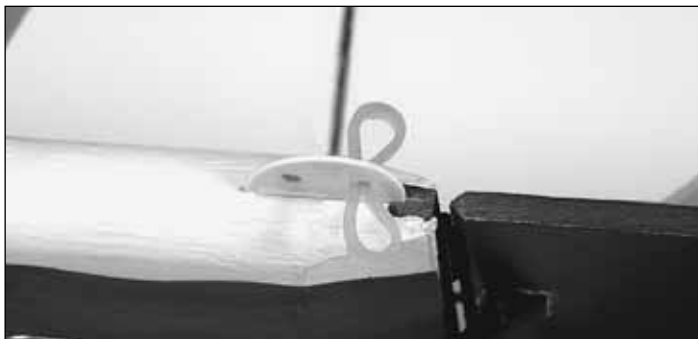

1. Insert a rubber band as shown.



2. Lay one end of a colored streamer over the mount. Insert one loop of the rubber band through the loop at the other end. Pull it tight to hold the streamer in place.
3. Secure the antenna to the fuselage. If left to trail the plane, it could become damaged while combating.

GET THE MODEL READY TO FLY

Check the Control Directions

1. Turn on the transmitter and receiver and center the trims. If necessary, remove the servo arms from the servos and reposition them so they are centered. Reinstall the screws that hold on the servo arms.
2. With the transmitter and receiver still on, check all the control surfaces to see if they are centered. If necessary, adjust the V-bends on the pushrods to center the control surfaces.

4-CHANNEL RADIO SETUP (STANDARD MODE 2)

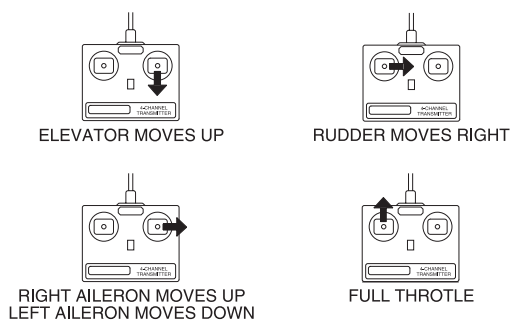

3. Make certain that the control surfaces and the motor respond in the correct direction as shown in the diagram. If any of the controls respond in the wrong direction, use the servo reversing in the transmitter to reverse the servos connected to those controls. Be certain the control surfaces have remained centered. Adjust if necessary.

Set the Control Throws

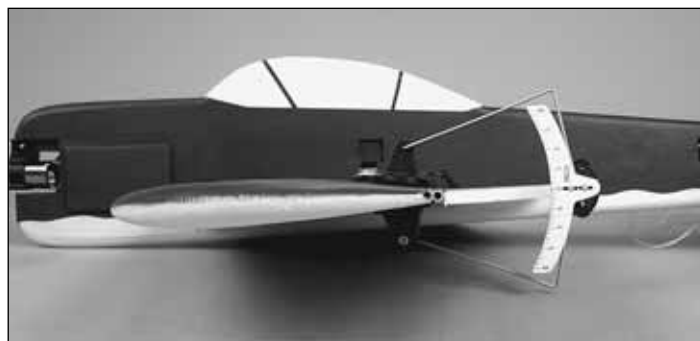

Use a Great Planes AccuThrow™ (or a ruler) to accurately measure and set the control throw of each control surface as indicated in the chart that follows. If your radio does not have dual rates, we recommend setting the throws at the **low rate**, or sport rate setting. **Note:** The 3D throws recommended are extreme throws and should only be flown by experienced pilots. They are very sensitive and could cause the plane to seem uncontrollable to a novice pilot. Sport rates are perfect, and recommended for, combat and general aerobatic flight.

Note: The throws are measured at the **widest part** of the elevators, rudder and ailerons.

These are the recommended control surface throws:

	High Rate/3D Rate	Low Rate/Sport Rate
ELEVATOR:	3-1/2" [89 mm] up 3-1/2" [89 mm] down	1-1/2" [38 mm] up 1-1/2" [38 mm] down
RUDDER:	3-1/2" [89 mm] right 3-1/2" [89 mm] left	2" [51 mm] right 2" [51 mm] left
AILERONS:	3" [76 mm] up 3" [76 mm] down	1-5/8" [41 mm] up 1-5/8" [41 mm] down

IMPORTANT: The EP Zero ARF has been **extensively** flown and tested to arrive at the throws at which it flies best. Flying your model at these throws will provide you with the greatest chance for successful first flights. If, after you have become accustomed to the way the EP Zero ARF flies, you would like to change the throws to suit your taste, that is fine. However, too much control throw could make the model difficult to control, so remember, "More is not always better."

Balance the Model (C.G.)

More than any other factor, the C.G. (balance point) can have the greatest effect on how a model flies, and may determine whether or not your first flight will be successful. If you value this model and wish to enjoy it for many flights, **DO NOT OVERLOOK THIS IMPORTANT PROCEDURE.** A model that is not properly balanced will be unstable and possibly unflyable.

At this stage the model should be in ready-to-fly condition with all of the systems in place.

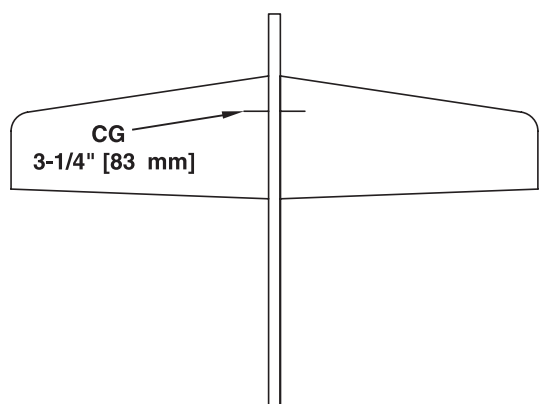

1. Use a felt-tip pen or 1/8" [3 mm]-wide tape to accurately mark the C.G. on the top of the wing on both sides of the fuselage. The C.G. is located 3-1/4" [83 mm] back from the leading edge of the wing.

This is where your model should balance for the first flights. Later, you may wish to experiment by shifting the C.G. up to 1/4" [6.4 mm] forward or 3/4" [19 mm] back to change the flying characteristics. Moving the C.G. forward may improve the smoothness and stability, but the model may then require more speed for takeoff and be more difficult to slow for landing. Moving the C.G. aft makes the model more maneuverable, but could also cause it to become too difficult to control. In any case, **start at the recommended balance point** and do not at any time balance the model outside the specified range.

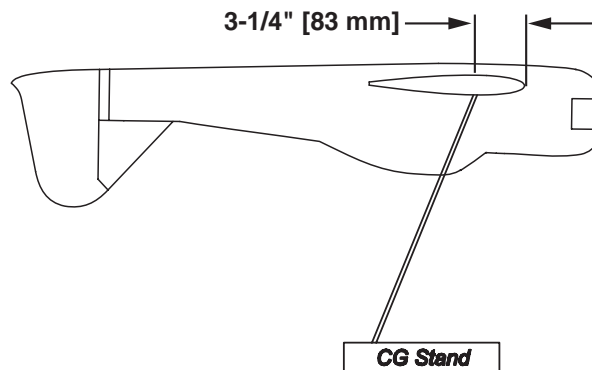

2. With the wing attached to the fuselage and all parts of the model installed (ready to fly), place the model upside-down on a Great Planes CG Machine, or lift it upside-down at the balance point you marked.

3. If the tail drops, the model is "tail heavy" and weight must be added to the nose to balance. If the nose drops, the model is "nose heavy" and weight must be added to the tail to balance. If additional weight is required, use Great Planes (GPMQ4485) "stick-on" lead. A good place to add stick-on nose weight is to the bottom of the fuse at the nose (don't attach weight to the battery box—it is not intended to support weight). Begin by placing incrementally increasing amounts of weight on the bottom of the fuse under the nose until the model balances. Once you have determined the amount of weight required, it can be permanently attached. If required, tail weight may be added in the same manner.

4. **IMPORTANT:** If you found it necessary to add any weight, recheck the C.G. after the weight has been installed.

Balance the Model Laterally

1. With the wing level, have an assistant help you lift the model by the motor propeller shaft and the bottom of the fuse under the TE of the fin. Do this several times.

2. If one wing always drops when you lift the model, it means that side is heavy. Balance the airplane by adding weight to the other wing tip. **An airplane that has been laterally balanced will track better in loops and other maneuvers.**

PREFLIGHT

Identify Your Model

No matter if you fly at an AMA sanctioned R/C club site or if you fly somewhere on your own, you should always have your name, address, telephone number and AMA number on or inside your model. It is **required** at all AMA R/C club flying sites and AMA sanctioned flying events. Fill out the identification tag on page 17 and place it on or inside your model.

Charge the Batteries

Follow the battery charging instructions that came with your radio control system to charge the batteries. You should always charge your transmitter and receiver batteries the night before you go flying, and at other times as recommended by the radio manufacturer.

CAUTION: Unless the instructions that came with your radio system state differently, the **initial** charge on **new** transmitter and receiver batteries should be done for 15 hours **using the slow-charger that came with the radio system**. This will "condition" the batteries so that the next charge may be done using the fast-charger of your choice. If the initial charge is done with a fast-charger, the batteries may not reach their full capacity and you may be flying with batteries that are only partially charged.

Balance the Propellers

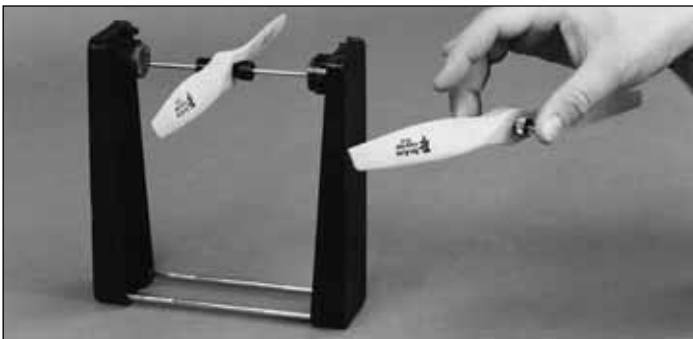

Carefully balance your propeller and spare propellers before you fly. An unbalanced prop can be the single most significant cause of vibration that can damage your model. Not only will motor mounting screws and bolts loosen, possibly with disastrous effect, but vibration may also damage your radio receiver and battery. When balancing the propeller that came with your Fun Force ARF, add tape to the light side of the propeller. Do not shave material away as is done with traditional propellers.

We use a Top Flite Precision Magnetic Prop Balancer™ (TOPQ5700) in the workshop and keep a Great Planes Fingertip Prop Balancer (GPMQ5000) in our flight box.

Ground Check

Check the motor operation by running it to full power and back down. It should respond quickly and smoothly through the full range of throttle travel. After you run the motor on the model, inspect the model closely to make sure all screws remained tight, the hinges are secure, the prop is secure and all pushrods and connectors are secure.

Range Check

It is important to ground check the operational range of your radio before the first flight of the day. With the transmitter antenna collapsed and the receiver and transmitter on, you should be able to walk at least 100 feet [30.5 m] away from the model and still have control. Have an assistant hold your model and, while you work the controls, tell you what the control surfaces are doing. Repeat this test **with the motor running** at various speeds with an assistant holding the model, using hand signals to show you what is happening. If the control surfaces do not respond correctly, **do not fly!** Find and correct the problem first. Look for loose servo connections or broken wires, corroded wires on old servo connectors, poor solder joints in your battery pack or a defective cell, or a damaged receiver crystal from a previous crash.

MOTOR SAFETY PRECAUTIONS

Failure to follow these safety precautions may result in severe injury to yourself and others.

Get help from an experienced pilot when learning to operate motors.

Use safety glasses when starting or running motors.

Do not run the motor in an area of loose gravel or sand; the propeller may throw such material in your face or eyes.

Keep your face and body as well as all spectators away from the plane of rotation of the propeller as you start and run the motor.

Keep these items away from the prop: loose clothing, shirt sleeves, ties, scarves, long hair or loose objects such as pencils or screwdrivers that may fall out of shirt or jacket pockets into the prop.

The motor gets hot! Do not touch it during or right after operation.

Do not throw anything into the propeller of a running motor.

AMA SAFETY CODE (excerpts)

Read and abide by the following excerpts from the Academy of Model Aeronautics Safety Code. For the complete Safety Code refer to *Model Aviation* magazine, the AMA web site or the Code that came with your AMA license.

General

1) I will not fly my model aircraft in sanctioned events, air shows, or model flying demonstrations until it has been proven to be airworthy by having been previously, successfully flight tested.

2) I will not fly my model aircraft higher than approximately 400 feet within 3 miles of an airport without notifying the airport operator. I will give right-of-way and avoid flying in the proximity of full-scale aircraft. Where necessary, an observer shall be utilized to supervise flying to avoid having models fly in the proximity of full-scale aircraft.

3) Where established, I will abide by the safety rules for the flying site I use, and I will not willfully and deliberately fly my models in a careless, reckless and/or dangerous manner.

5) I will not fly my model unless it is identified with my name and address or AMA number, on or in the model. **Note:** This does not apply to models while being flown indoors.

7) I will not operate models with pyrotechnics (any device that explodes, burns, or propels a projectile of any kind).

Radio Control

1) I will have completed a successful radio equipment ground check before the first flight of a new or repaired model.

2) I will not fly my model aircraft in the presence of spectators until I become a qualified flier, unless assisted by an experienced helper.

3) At all flying sites a straight or curved line(s) must be established in front of which all flying takes place with the other side for spectators. Only personnel involved with flying the aircraft are allowed at or in the front of the flight line. Intentional flying behind the flight line is prohibited.

4) I will operate my model using only radio control frequencies currently allowed by the Federal Communications Commission.

5) **I will not knowingly operate my model within three miles of any pre-existing flying site except in accordance with the frequency sharing agreement listed** [in the complete AMA Safety Code].

9) Under no circumstances may a pilot or other person touch a powered model in flight; **nor should any part of the model other than the landing gear, intentionally touch the ground, except while landing.**

CHECK LIST

During the last few moments of preparation your mind may be elsewhere anticipating the excitement of the first flight. Because of this, you may be more likely to overlook certain checks and procedures that should be performed before the model is flown. To help avoid this, a *check list* is provided to make sure these important areas are not overlooked. Many are covered in the instruction manual, so where appropriate refer to the manual for complete instructions. Be sure to check the items off as they are completed.

- 1. Check the C.G. according to the measurements provided in the manual.
- 2. Be certain the battery and receiver are securely mounted in the fuse.
- 3. Extend your receiver antenna. Be careful to keep pressure off the solder joint inside the receiver.
- 4. Balance your model *laterally* as explained in the instructions.
- 5. Make sure all hinges are **securely** glued in place.
- 6. Confirm that all controls operate in the correct direction and the throws are set up according to the manual.
- 7. Make sure any servo extension cords you may have used do not interfere with other systems (servo arms, pushrods, etc.).
- 8. Balance your propeller (and spare propellers).
- 9. Tighten the prop saver screws.
- 10. Place your name, address, AMA number and telephone number on your model.
- 11. Cycle your battery pack (if necessary) and make sure it is fully charged.
- 12. If you wish to photograph your model, do so before your first flight.
- 13. Range check your radio when you get to the flying field.

FLYING

The EP Zero ARF is a great-flying model that flies smoothly and predictably. The EP Zero ARF does not, however, possess the self-recovery characteristics of a primary R/C trainer and should be flown only by experienced R/C pilots.

CAUTION (THIS APPLIES TO ALL R/C AIRPLANES): If, while flying, you notice an alarming or unusual sound such as a low-pitched “buzz,” this may indicate control surface *flutter*. Flutter occurs when a control surface (such as an aileron or elevator) or a flying surface (such as a wing or stab) rapidly vibrates up and down (thus causing the noise). In extreme cases, if not detected immediately, flutter can actually cause the control surface to detach or the flying surface to fail, thus causing loss of control followed by an impending crash. The best thing to do when flutter is detected is to slow the model **immediately** by reducing power, then land as soon as safely possible. Identify which surface fluttered (so the problem may be resolved) by checking all the servo grommets for deterioration or signs of vibration. Make certain all pushrod linkages are secure and free of play. If it fluttered once, under similar circumstances it will probably flutter again unless the problem is fixed. Some things which can cause flutter are; Excessive hinge gap; Not mounting control horns solidly; Poor fit of clevis pin in horn; Side-play of wire pushrods caused by large bends; Excessive free play in servo gears; Insecure servo mounting; and one of the most prevalent causes of flutter; Flying an over-powered model at excessive speeds.

Launch

For the first flight, it is a good idea to have a friend launch the airplane for you. This allows you to keep your hands on the radio sticks and correct any trim problems that are present. Have your friend hold the EP Zero ARF by the canopy. Throttle up to full power, and have your friend give the plane a gentle underhanded toss at about a 30° angle upward. Since the EP Zero ARF has a very high thrust to weight ratio, the plane will accelerate to flying speed almost instantly. Climb to a comfortable altitude and throttle back to a lower power setting. This plane flies great at about half-throttle when in standard forward flight.

Flight

For reassurance and to keep an eye on other traffic, it is a good idea to have an assistant on the flight line with you. Tell him to remind you to throttle back once the plane gets to a comfortable altitude. While full throttle is usually desirable for takeoff, most models fly more smoothly at reduced speeds. Take it easy with the EP Zero ARF for the first few flights, gradually getting acquainted with it as you gain confidence. Adjust the trims to maintain straight and level flight. After flying around for a while, and while still at a safe altitude with plenty of battery power, practice slow flight and execute practice landing approaches by reducing the throttle to see how the model handles at slower speeds. Add power to see how she climbs as well. Continue to fly around, executing various maneuvers and making mental notes (or having your assistant write them down) of what trim or C.G. changes may be required to fine tune the model so it flies

the way you like. Mind your battery power, but use this first flight to become familiar with your model before landing.

Landing

To initiate a landing approach, lower the throttle while on the downwind leg. Allow the nose of the model to pitch downward to gradually bleed off altitude. Continue to lose altitude, but maintain airspeed by keeping the nose down as you turn onto the crosswind leg. Make your final turn toward the landing area (into the wind), keeping the nose down to maintain airspeed and control. Level the attitude when the model reaches an altitude of about 10 feet, modulating the throttle as necessary to maintain your glide path and airspeed. If you are going to overshoot, smoothly advance the throttle (always ready on the right rudder to counteract torque) and climb out to make another attempt. When you're ready to make your landing and the model is a foot or so off the deck, cut your throttle and smoothly increase up elevator until it gently touches down on its belly. Make sure that you cut your power completely before touchdown, or gearbox damage may result.

One final note about flying your model: Have a goal or flight plan in mind for **every** flight. This can be learning a new maneuver(s), improving a maneuver(s) you already know, or learning how the model behaves in certain conditions (such as on high or low rates). This is not necessarily to improve your skills (*though it is never a bad idea!*), but more importantly so you do not surprise yourself by impulsively attempting a maneuver and suddenly finding that you've run out of time, altitude or airspeed. Every maneuver should be deliberate, not impulsive. For example, if you're going to do a loop, check your altitude, mind the wind direction (anticipating rudder corrections that will be required to maintain heading), remember to throttle back at the top, and make certain you are on the desired rates (high/low rates). A flight plan greatly reduces the chances of crashing your model just because of poor planning and impulsive moves. **Have a ball! But always stay in control and fly in a safe manner.**

GOOD LUCK AND GREAT FLYING!

This model belongs to:

Name
Address
City, State Zip
Phone number
AMA number

Fill in and place on or inside your model.

OTHER ITEMS AVAILABLE FROM GREAT PLANES



Great Planes ElectriFly Yak 55 EP 3D ARF

You don't need expensive brushless motor systems for 3D electric aerobatics. The Yak's enormous control surfaces and full flying stabilizer offer impressive maneuverability and hovering potential with the powerful, included 280-size brushed motor and 5:1 gearbox. Its low parts count and easy final assembly will have this aerobat flight-ready in just 2-3 hours. The durable, lightweight EPS foam airframe features a high-vis, preapplied trim scheme. An included "prop saver" allows the prop to deflect back upon landing, and is compatible with APC or GWS prop hubs. **GPMA1190**

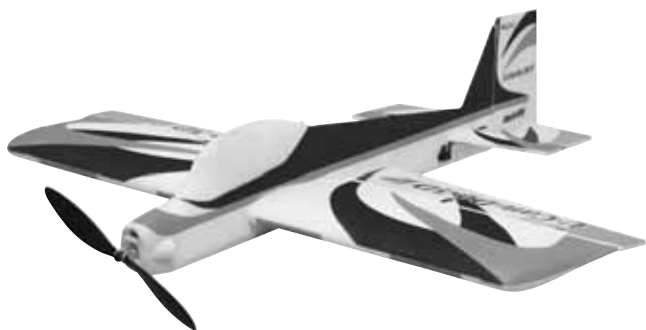

Great Planes ElectriFly U-Can-Do 3D EP ARF

It's a park flyer, ARF and 3D trainer all in one! Less than a yard across the wing tips and weighing just 15 ounces, the U-Can-Do 3D EP is small enough to fly at nearby parks and fields. And its unique FlightFlex airframe not only simplifies assembly to just 2 to 4 easy hours...it also results in virtual indestructibility! Touch down hard – it'll bounce and bend, but not break. With the included ball bearing 280 motor, 5:1 gearbox and prop, it flies like a champ, performing hovers, harriers and any other 3D stunt you care to name with authority. **GPMA1275**

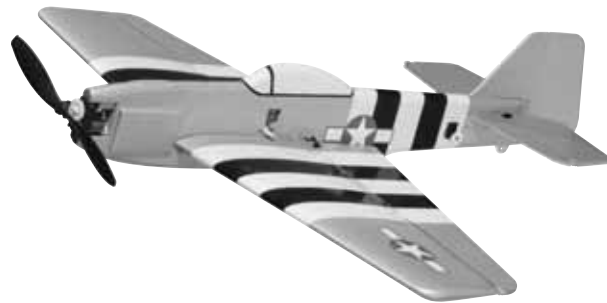

ElectriFly Fun Force P-51D Mustang EP Sport Combat ARF

It's fun for sport, fun for combat – and easily affordable whichever way you go! The P-51D Mustang's 33.5" wingspan makes any open area a potential flying field. Minimal assembly and a factory-applied, semi-scale trim scheme enable you to get to the field fast. Carbon-fiber tubes and EPS foam construction enable your plane to last and last. If you're content with slow and steady flight, it's ready to please. But with its light weight, symmetrical airfoil and large control surfaces, this favorite American warbird is also capable of sudden right-angle turns and table-turning moves in combat. Attach the included streamers, and you're ready for a dogfight! Includes complete hardware and a motor package that features a Speed Force 370 BB motor, 5:1 gearbox, prop and prop saver. **GPMA1192**



ElectriFly Fun Force FW-190 Focke Wulf EP Sport Combat ARF

It's fun for sport, fun for combat – and easily affordable whichever way you go! The FW-190 Focke Wulf's 33.5" wingspan makes any open area a potential flying field. Minimal assembly and a factory-applied, semi-scale trim scheme enable you to get to the field fast. Carbon-fiber tubes and EPS foam construction enable your plane to last and last. If you're content with slow and steady flight, it's ready to please. But with its light weight, symmetrical airfoil and large control surfaces, this feared German fighter is also capable of sudden right-angle turns and table-turning moves in combat. Attach the included streamers, and you're ready for a dogfight! Includes complete hardware and a motor package that features a Speed Force 370 BB motor, 5:1 gearbox, prop and prop saver. **GPMA1193**



ElectriFly™ by Great Planes Triton™ Peak Charger

Imagine a charger so versatile it can be used with lithium-ion and lead-acid batteries as effectively as NiCd and NiMH cells. A unit that can peak charge tiny park flyer packs and 24V car batteries alike. A charger that can discharge as well as charge, cycle packs from 1 to 10 times automatically, memorize peak and average battery voltages for each cycle – and constantly display battery capacity, voltage, current and time as each cycle progresses. Then, imagine that the charger, which can do all this, is about the size of a thick paperback book, and weighs just over a pound. The advanced computer technology in the Triton Peak Charger makes it possible to accomplish all this and more, through controls and menus so simple that programming is a breeze. For more information, log on at www.electrifly.com – and be amazed. 1-year warranty. **GPMM3150**



Great Planes ElectriFly PolyCharge Charger

Simple to set up and use, the PolyCharge is perfect for 1-3 cell LiPo power packs. It's about the size of a business card – and weighs just over 4 ounces! PolyCharge automatically starts charging when the pack is connected, and automatically stops at full charge. Adjusting the charge rate to capacity takes only a moment and a touch on the selector switch. Choose from 250mA, 500mA or 1,000mA rates. A buzzer and blue LED indicate start/stop charge; high/low voltage input; reverse polarity (output), and loose/broken pack connection. Includes alligator clips on a 30" lead for input and a standard red 2-pin connector on output. **GPMM3010**



Great Planes ElectriFly 1500mAh Lithium-Polymer Battery

Lithium-Polymer (LiPo) cells provide three times the voltage of NiCd and NiMH cells – at less than half the weight! Exclusive SafeCharge™ circuitry protects ElectriFly LiPo packs by preventing any cell from overcharging. This 11.1V, 3 series pack includes a 2-pin red charge connector and separate discharge connector. **GPMP0831**



Futaba 4EXA 4-Channel FM Computer Radio

If you're a new pilot, the 4EXA is a good deal – and a good deal for the future, too. You'll enjoy the performance edge and ease of computer design, beginning with simple programming: navigate menus and select your set-ups using just two keys (Mode and Select), and then lock-in those digitally accurate settings with the Data Input Lever. You can save up to four set-ups in the 4EXA's memory...a big time-saver as you add more planes to your personal hangar.

You'll also enjoy the 4EXA's versatility. With more channels than 2- or 3-channel systems and more features than most "start up" 4-channel radios, the 4EXA "grows" with you as your skills and experience increase. EPA for servos, automatic trim memory, exponential, wing mixing for V-tail and elevon – the 4EXA has them. You'll be able to experiment with new types of flying, with the familiar layout and feel of a system you already know.

Save yourself the cost and inconvenience of "trading up," with a radio that will be as useful tomorrow as it is today. The 4EXA includes an R124DF receiver, three S3108 servos and 600mAh Tx and Rx NiCds. 72MHz. **FUTK41****



Free Manuals Download Website

<http://myh66.com>

<http://usermanuals.us>

<http://www.somanuals.com>

<http://www.4manuals.cc>

<http://www.manual-lib.com>

<http://www.404manual.com>

<http://www.luxmanual.com>

<http://aubethermostatmanual.com>

Golf course search by state

<http://golfingnear.com>

Email search by domain

<http://emailbydomain.com>

Auto manuals search

<http://auto.somanuals.com>

TV manuals search

<http://tv.somanuals.com>