

AT STEREO COLOR TELEVISIONS

INSTRUCTION MANUAL

Standard - AT2408S, AT2708S



Please read this manual carefully before operation.

WARNING

To reduce the risk of fire or electric shock, do not expose this product to rain or moisture.

The apparatus shall not be exposed to dripping or splashing and that no objects filled with liquids, such as vases, shall be placed on the apparatus.



Caution: To reduce the risk of electric shock, do not remove cover (or back). No user serviceable parts inside. Refer servicing to qualified service personnel.



This symbol indicates "dangerous voltage" inside the product that presents a risk of electric shock or personal injury.



This symbol indicates important instructions accompanying the product.

Caution: To prevent electric shock, match wide blade of plug to wide slot, fully insert.

Refer to the identification/rating label located on the back panel of your product for its proper operating voltage.

Caution: Using video games or any external accessory with fixed images for extended periods of time can cause them to be permanently imprinted on the picture tube (or projection TV picture tubes). ALSO, some network/program logos, phone numbers, etc. may cause similar damage. This damage is not covered by your warranty.

Cable TV Installer: This reminder is provided to call your attention to Article 820-40 of the National Electrical Code (Section 54 of the Canadian Electrical Code, Part 1) which provides guidelines for proper grounding and, in particular, specifies that the cable ground shall be connected to the grounding system of the building as close to the point of cable entry as practical.

Customer Record

You will find the model number and chassis number of your TV on the back of your TV set. Record these numbers in the spaces provided below. Refer to them whenever you call APEX Digital customer service or your APEX dealer regarding this product.

Model Number: _____

Chassis Number: _____

IMPORTANT SAFETY INSTRUCTIONS

1. Read these instructions.
2. Keep these instructions.
3. Heed all warnings.
4. Follow all instructions.
5. Do not use this apparatus near water.
6. Clean only with dry cloth.
7. Do not block any ventilation openings. Install in accordance with the manufacturer's instructions.
8. Do not install near any heat sources such as radiators, heat registers, stoves, or other apparatus (including amplifiers) that produce heat.
9. Do not defeat the safety purpose of the polarized or grounding-type plug. A polarized plug has two blades with one wider than the other. A grounding type plug has two blades and a third grounding prong. The wide blade or third prong is provided for your safety. If the provided plug does not fit into your outlet, consult an electrician for replacement of the obsolete outlet.
10. Protect the power cord from being walked on or pinched particularly at plugs, convenience receptacles, and the point where they exit from the apparatus.
11. Only use attachments/accessories specified by the manufacturer.
12. Use only the cart, stand, tripod, bracket, or table specified by the manufacturer, or sold with the apparatus. When a cart is used, use caution when moving the cart/apparatus combination to avoid injury from tip-over.
13. Unplug this apparatus during lightning storms or when unused for long periods of time.
14. Refer all servicing to qualified service personnel. Servicing is required when the apparatus has been damaged in any way, such as power-supply cord or plug is damaged, liquid has been spilled or objects have fallen into the apparatus, the apparatus has been exposed to rain or moisture, does not operate normally, or has been dropped.
15. **Warning - This TV should only be serviced by an authorized and properly trained technician. Opening the cover or other attempts by the user to service this TV may result in serious injury or death from electrical shock, and may increase the risk of fire.**



IMPORTANT STAND AND BASE SAFETY INFORMATION

Choose the location for your TV carefully. Place the TV on a stand or base that is of adequate size and strength to prevent the TV from being accidentally tipped over, pushed off, or pulled off. This could cause personal injury and/or damage the TV. Refer to the Important Safety Instructions above.

FCC Warning

Class B Computing Device
Information to User

This equipment has been tested and found to comply with the limits for a Class B Digital Device pursuant to part 15 of FCC Rules. These limits are designed to provide reasonable protection against harmful interference in a residential installation. This equipment generates, uses, and can radiate radio frequency energy and, if not installed and used in accordance with the instructions, may cause harmful interference to radio communications. However, there is no guarantee that interference will not occur in a particular installation. If this equipment receives interference while off and on, the user is encouraged to try to correct the interference by one or more of the following measures:

- 1) Reorient or relocate the receiving antenna.
- 2) Increase the separation between the equipment and TV.
- 3) Connect the equipment into an outlet on a circuit different from that to which the TV is connected.
- 4) Consult the dealer or an experienced radio/TV technician for help and for additional suggestions.

The user may find the following booklet prepared by the Federal Communications Commission helpful: "How to Identify and Resolve Radio - TV Interference Problems". This booklet is available from the US Government Printing Office, Washington, D.C. 20402, Stock No. 004-000-00345-4.

FCC Warning

The user is cautioned that changes or modifications not expressly approved by the manufacturer could void the user's authority to operate the equipment.

NOTE: In order for an installation of the product to maintain compliance with the limits for a Class B Device, shielded cables must be used.

TABLE OF CONTENTS

INTRODUCTION	
Safety Instructions	1
Specifications.....	3
Feature Descriptions	4
Front and Rear Unit Profiles	5
Remote Control Features	6
INSTALLATION	
Connecting the Antenna	7
Installing the Remote Control Batteries.....	7
Connecting A/V Equipment	
Input from Device to TV	8
Output from TV to Device	8
FUNCTIONS & FEATURES	
Turn On/Off	9
Basic Functions	
Changing the Channel	9
Adjusting the Volume	9
Muting the Volume	9
Function Selection Menus	
Picture Menu.....	9
Audio Menu	9
Tuner Menu	10
Timer Menu	10
System Menu	
On Screen Display Language Select	10
Blue Background	10
Closed Caption.....	10
Parental Guide	11
Useful Remote Control Features	12
TROUBLESHOOTING GUIDE	13
LIMITED UNITED STATES WARRANTY	14

SPECIFICATIONS

MODEL	AT2408S	AT2708S
Television System	NTSC-M	NTSC-M
Channel Coverage	VHF 2-13, UHF 14-69	VHF 2-13, UHF 14-69
Cable TV Coverage	Mid Band (A-8~A-1, A~I); Super Band (J~W) Hyper Band (AA~ZZ, AAA, BBB) Ultra Band (65~94, 100~125)	Mid Band (A-8~A-1, A~I); Super Band (J~W) Hyper Band (AA~ZZ, AAA, BBB) Ultra Band (65~94, 100~125)
Channels Preset	181	181
Antenna Input	75 ohm (unbalanced)	75 ohm (unbalanced)
Screen Dimensions	18.8 x 14.3 in 478 x 363 mm	21.3 x 15.9 in 540 x 405 mm
Audio Output	5W + 5W	5W + 5W
Total Harmonic Distortion	<7%	<7%
Power Source	~120Vac 60Hz	~120Vac 60Hz
Unit Weight	69 lbs. (31.5 kg)	88 lbs. (40 kg)
Unit Dimensions	26.0 x 20.6 x 18.0 in 660 x 522 x 458 mm	29.5 x 23.2 x 18.7 in 750 x 589 x 474 mm
Packaged Dimensions	29.1 x 24.0 x 21.5 in 740 x 610 x 545 mm	33.5 x 27.2 x 22.8 in. 852 x 692 x 580 mm
Power Consumption	125W	135W

Feature Descriptions

181 Channel Tuner - total number of channels the TV can receive: 2-69 in Air mode, or 1-125 in Cable mode

AV Input (Rear) - input designed for use with A/V devices, such as a VCR or DVD player

AV Input (Front) - input designed for infrequent use, such as with a camcorder or video game unit

AV Output (Rear) - output signals from TV to devices such as a VCR

AV Stereo Sound - stereo sound for superior TV viewing experience

Channel Recall - instant return to the last channel viewed

Closed Caption Display - feature that displays the closed captions or text of a TV broadcast

Remote Control - A wireless remote control unit for the TV

On/Off Timer - feature that allows the user to set a timer to turn on/off the TV

Parental Control - feature that allow parents to block out selected type of programming

RF IN Jack - standard coaxial antenna jack

S-Video Input - input designed for greater clarity and sharpness; also known as S-VHS

Screen Size - the diagonal size of the TV screen

Selectable Picture Modes - preset standards for TV display: Memory, Theater and Normal

Selectable Sound Modes - preset standards for TV sound: Memory, Speech, Music and Theater

Trilingual On Screen Display (OSD) - TV's on screen display, can be either English, French or Spanish

FEATURE	AT2408S	AT2708S
181 Channel Tuner	●	●
AV Input (Rear)	3	3
AV Input (Front)	-	1
AV Input (Side)	-	-
AV Output (Rear)	1	1
Channel Recall	●	●
Closed Captions	●	●
Full Feature Remote	●	●
On/Off Timer	●	●
Parental Control	●	●
RF IN Jack	●	●
S-Video Input	1	1
Screen Size	24"	27"
Picture Modes	●	●
Trilingual OSD	●	●
Sound Modes	●	●

PACKING LIST

Parts	QTY
Color TV Receiver	1
Remote Control	1
Operation Manual	1
AAA Alkaline Batteries	2

Front and Rear Unit Profiles

Front panel

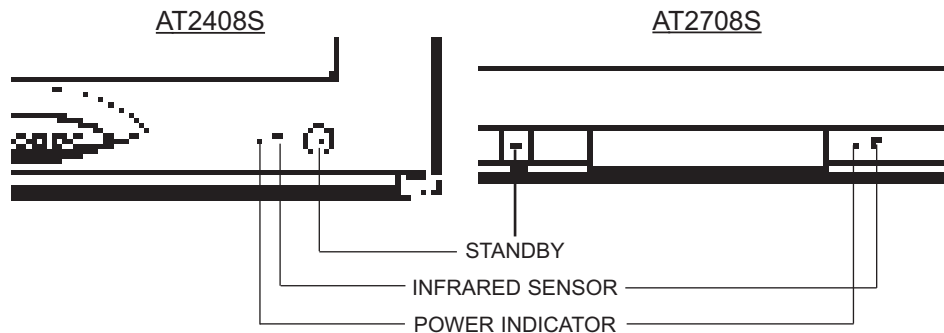

AT2408S

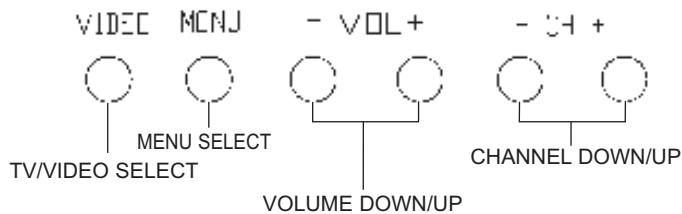

AT2708S

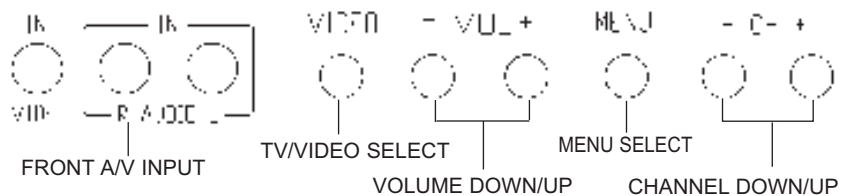

Rear panel



Remote Control Features

FUNCTION Used for volume control and child lock

KEYPAD Used to select channels by number

100+ Three digit select

TIMER Accesses the Timer menu

ARROWS Used to navigate the TV menus

SCAN Scans all the active channels

PICTURE Selects the various Picture Modes

SOUND Selects the various Sound Modes

RECALL Returns to the last channel viewed

CC Activates Closed Captioning

STANDBY Turns on/off the TV

CH +/- Used to change the current channel

VOL +/- Used to adjust the volume level

DISPLAY Brings up the TV/Video display

MENU Brings up the main Menu

STEREO Selects the Stereo modes among On/L/R

MUTE Mutes or restores the TV volume

VIDEO Cycles through the Video/TV modes

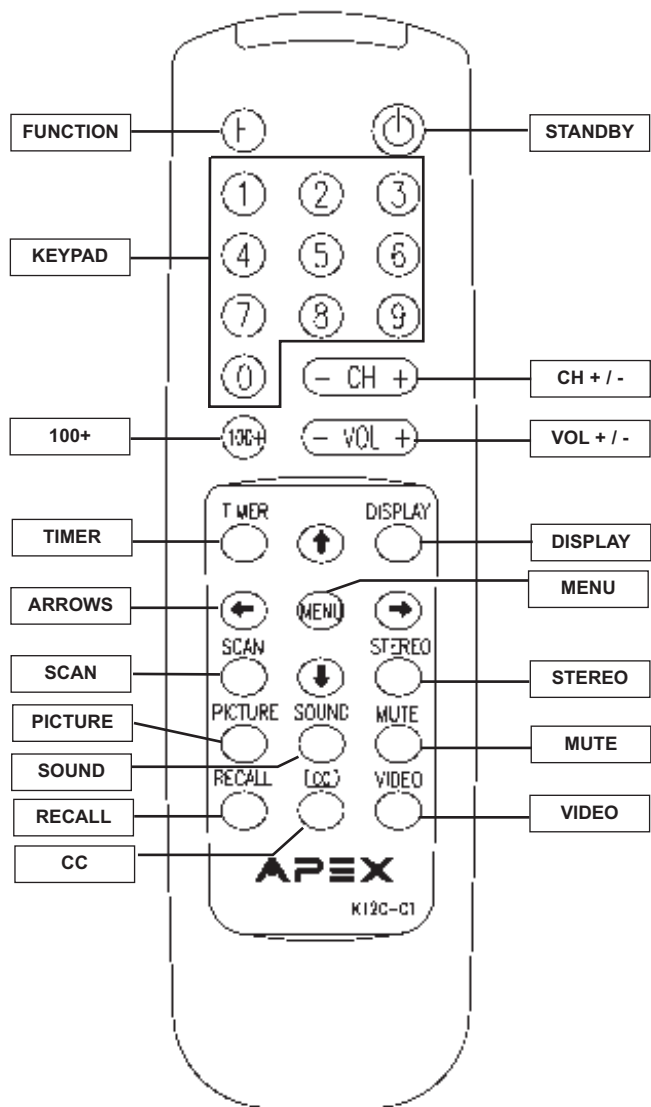

INSTALLATION

- Please read the safety instructions in this manual completely before installation.
- Install your TV in an area where direct sunlight will not fall upon the screen.
- Soft, indirect light is best for television viewing.
- Allow enough space (at least 4 in.) between the TV and any walls or enclosures for proper ventilation.
- Optimum television viewing distance is 3-5 times the screen's size.

Auto-Degaussing

Color television can be easily affected by magnetism, which shows as color distortion on the screen. If your TV is affected by nearby magnetic components or appliances, turn it off for a few minutes. The built-in auto-degaussing circuit will eliminate the magnetic interference.

Auto off when no signal received

The TV set will automatically enter into Standby mode when the following conditions are met.

1. TV is in antenna mode.
2. Current channel has no signal.
3. No key is pressed within 15 minutes.

Connecting the Antenna

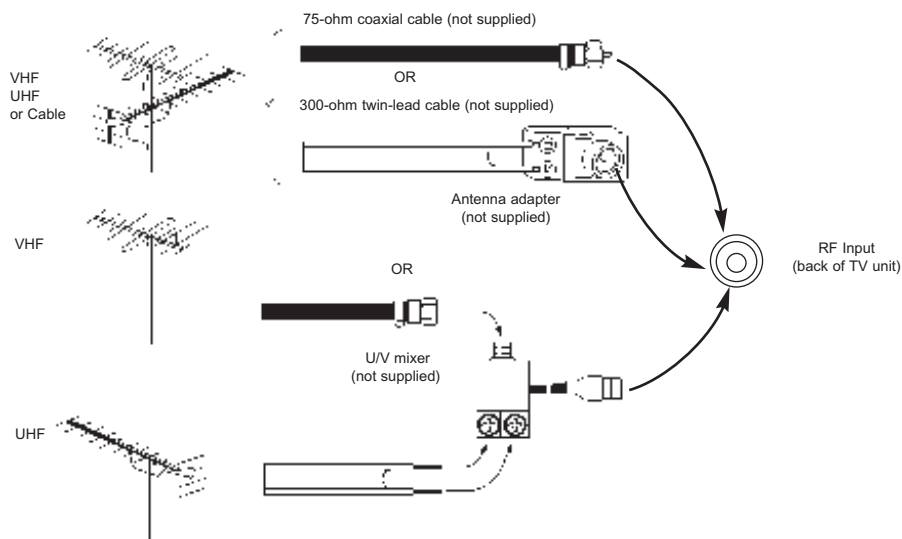

Notes:

1. It is recommended that a 75 ohm coaxial cable be used in order to eliminate interference and noise which may occur due to nearby radio transmissions.
2. The antenna cable should not be tied together with other wiring.
3. Set up a lightning rod and check it regularly when an outdoor antenna is used.

Installing the Remote Control Batteries

1. Remove the battery compartment lid.
2. Insert two AAA batteries (included). Make sure the positive (+) and negative (-) polarities are correctly aligned.
3. Reattach the battery lid.

Notes:

1. Alkaline batteries are recommended for longer life.
2. Always replace both batteries at the same time.
3. Do not expose batteries to fire or break them open.
4. To avoid battery leakage, remove batteries from the remote control when it is not being used for a long period of time.

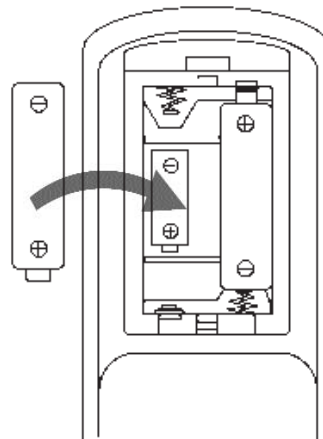

INSTALLATION (continued)

Connecting A/V Equipment

The following are diagrams showing basic instructions for attaching external equipment, like a VCR or DVD player, to your TV set. Please refer to operation manuals of external audio/video equipment that will be connected to your set for additional instructions. PLEASE TURN OFF ALL POWER BEFORE CONNECTING DEVICES TOGETHER.

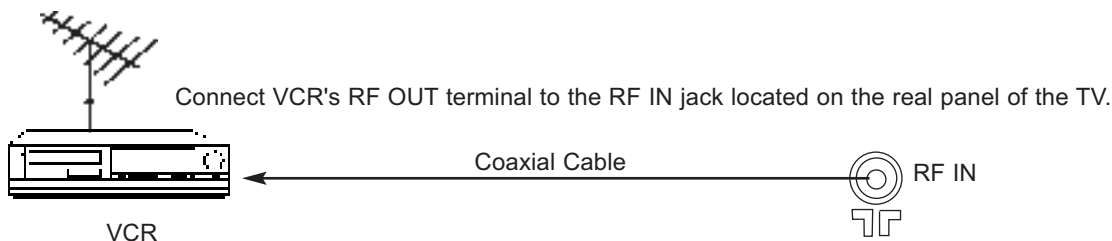

Input from Device to TV

AUDIO/VIDEO OUT

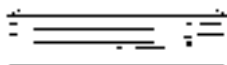

DVD Player

DO NOT connect both composite (yellow video terminal) and S-Video terminal. Use only one of the two. **Also, remember to connect the audio cables when using S-Video.**

The front terminals may be easier to use with a camcorder. The connections are identical.

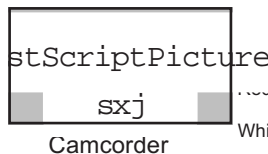

Camcorder

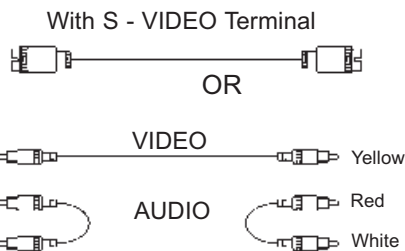

VCR

Output from TV to Device

AUDIO/VIDEO IN



VCR

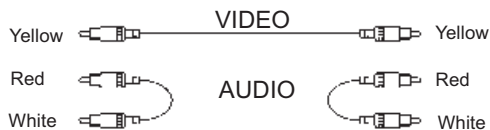

FUNCTIONS & FEATURES

Turn On/Off

1. Turn On
Plug in the power cord, and the TV should enter into Standby mode and its power indicator should light. Pressing STANDBY or the CH+/- key will turn on the TV and the power indicator will turn off.
2. Standby (Soft Off)
While the TV is on, press the STANDBY key will put the TV in Standby mode.

Basic Functions

Changing the Channel

While in Tuner mode, press the CH +/- keys to change the channel, or use the numeric keypad to enter a new channel.

Adjusting the Volume

To adjust the volume, press the VOL +/- keys. Also, you may press the FUNCTION (F) key along with the VOL +/- keys to adjust the volume in increments or decrements of 4.

Muting the Volume

To mute the volume, press the MUTE key. To restore the volume, press MUTE again or press the VOL + key.

Function Selection Menus

To change the setting of any function, press the MENU key to bring up the main menu. Press the up or down arrow key to highlight the desired sub-menu and press the left or right arrow key to access. While in the sub-menu, use the up or down arrow key to select the item and the left or right arrow to adjust the setting. Press the MENU key to return to the main menu and exit.

While in the setup menu, CH-/+ and VOL-/+ keys on the front panel will function as the down/up/left/right arrow keys on the remote control.

Picture Menu

Features

This menu allows you to adjust the various picture settings. Use the up or down arrow key to move between the various settings, and the left or right arrow key to adjust them.

- Tint:** -31 (more greenish) to +31 (more purplish)
Brightness: 0 (dimmiest) to 63 (brightest)
Contrast: 0 (minimum contrast) to 63 (maximum contrast)
Color: 0 (minimum color) to 63 (maximum color)
Sharp: 0 (minimum sharpness) to 63 (maximum sharpness)

Picture	
 Tint00
Brightness31
Contrast31
Color31
Sharp31

Audio Menu

Features

This menu allows you to adjust the various audio settings. Use the up or down arrow key to move between the various settings, and the left or right arrow key to adjust them.

- Bass:** 0 (less Bass) to 63 (more Bass)
Treble: 0 (less Treble) to 63 (more Treble)
Balance: L31 (Left Dominance) to R31 (Right Dominance)
Surround: Off; Low (slight surround effect); High (marked surround effect)

Audio	
 Bass31
Treble31
Balance00
Surround	Low

FUNCTIONS & FEATURES (continued)

Tuner Menu

Note: This menu is only accessible while the TV is in Tuner mode.

Channel: This feature allows you to change the channel displaying on screen. Use the left or right arrow key or the numeric keypad to change the channel.

Add/Erase: This feature allows you to add or remove the channel currently display on screen to the "active channel list" . Active channel list is the list of channel that is available by pressing the CH+/- keys. Use the left or right arrow key to add or erase.

Antenna: This feature sets the TV tuner to an Air antenna or a Cable antenna. Please use *Air* mode when using an over-the-air antenna; use *Cable* mode for a cable hookup. Use the left or right arrow key to select between the two options.

Auto Program: This feature will setup the Active channel list for the user. The list will include only the channels with a signal detected. Press the right arrow key to begin and the left arrow key to stop the process.

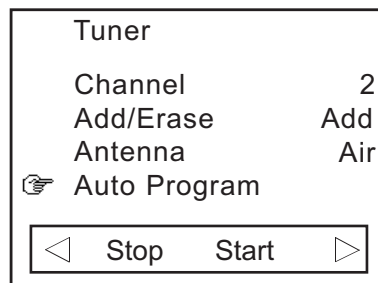

Timer Menu

Press the TIMER key on the remote control to access this menu.

Time
This feature allows you to set the clock on the TV.

On Time
This feature allows you to preset a time when the TV set will turn on.

On Channel
This feature allows you to preset the channel on display when the On Time is activated.

Off Time
This feature allows you to preset a time when the TV set will turn off.

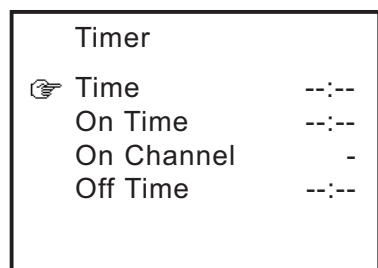

System Menu

Language
This feature allows you to pick a language used for the on screen display (OSD). Use the left or right arrow key to select the language of your choice - English (Eng.), French (Fra.) or Spanish (Esp.).

Blue Background
This feature gives you the option to display a blue background on the TV screen when there is no signal present. Use the left or right arrow key to toggle between on and off.

Closed Caption
Closed caption is a feature that allows your TV set to display, on screen, the dialogue, narration, and sound effect of a TV program. It also allows you to display teletext signal. Text and caption will be displayed at either the top or the bottom of the screen. There is nine different setting for closed caption. You can set it to one of the 4 Closed Caption settings (CC1-4), one of the 4 Text settings (T1-4), or set this feature to off (CCD/Text Off).

Notes: A Closed Caption signal may not be display under the following conditions:
-When there is no Closed Caption/Text signal to decode
-When the signal is weak or altered (due to interference or poor reception)
-When viewing a dubbed video tape

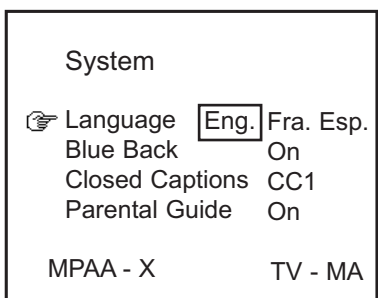

FUNCTIONS & FEATURES (continued)

System Menu (continued)

Parental Guide

This feature allows parents to block certain programs from being viewed, based on the programs' rating. In order to access this menu, you must first enter a pass code. The factory default is **6688**. Enter the pass code while the Parental Guide is highlighted. Now, with Parental Guide set as On, press the right arrow key to access the TV Rating grid.

System	
Language	Eng. Fra. Esp.
Blue Back	On
Closed Captions	CC1
Parental Guide	On
MPAA-X	TV-MA
Enter Pass Code - - - -	

TV Rating Grid

Using the up or down arrow key to navigate between the ratings, press the MENU key to block out a particular rating completely. Or, if you wish, press the down arrow key to highlight an individual rating (anywhere a *U* is displayed in the middle of the grid.) Pressing the MENU key with one of these individual ratings highlighted will block only programs that feature that particular aspect. See the TV rating diagram at right for an example. TV ratings are defined in the charts below:

Age	Defined as
TV - Y	All Children
TV - Y7	Directed to Older Children (over 7)
TV - G	General Audience
TV - PG	Parental Guidance Suggested
TV - 14	Parents Strongly Cautioned
TV - MA	Mature Audience Only

Contents	Defined as
FV	Fantasy Violence
D	Sexual Dialogue
L	Adult Language
S	Sexual Situations
V	Violence

TV Rating Grid

TV-Rating	
Rating	FV D L S V
TV-Y	U
TV-Y7	U U
TV-G	U
TV-PG	U U U U
TV-14	B B B B B
TV-MA	B B B B
Age Based Rating	

MPAA Rating Grid

Press the right arrow key while in the TV Rating grid to access this grid. Use the up or down arrow key to navigate between the MPAA ratings. Pressing the MENU key with a rating highlighted will block that particular rating from being shown on this TV. A *B* will show in red next to the blocked rating. Please note that blocking a lower rating (for example, PG) will block all higher ratings (PG-13, R, NC-17, X.)

MPAA Rating Grid

MPAA - Rating	
Movie	Rating
G	U
PG	U
PG-13	U
R	U
NC-17	U
X	U
Age Based Rating	

Pass Code Menu

This menu allows you to change the access code for the Parental Guide functions of the TV set. Press the MENU key when Pass Code Control is highlighted. This will turn on or off the Pass Code function. With the Pass Code function ON, you can also change the Pass Code. Use the down arrow key to highlight *Pass Code*, then enter the new Pass Code using the numeric keypad.

Pass Code Menu Grid

Pass Code Menu	
	Pass Code Control
	Pass Code 6688
Enter Pass Code - - - -	

Note: The factory default pass code of 6688 is also the override code, in case you forget your new pass code.

FUNCTIONS & FEATURES (continued)

Useful Remote Control Features

DISPLAY

This key allows you to display the current information of the TV screen on the upper right hand corner of the screen. (channel, antenna mode, time, video, etc.)

TIMER

This key allows you to directly access the *Timer* menu. For an explanation of this menu features, please see page 10.

SCAN

Press the SCAN key twice, and the TV will begin to scan through all active channels. To stop the Scan, pressing any key can interrupt scanning. Please note that Scan will only work in Antenna mode.

PICTURE

Your TV has factory preset picture modes that allow you to optimize your TV viewing. To activate these picture modes, press the PICTURE key, and you can choose among Memory, Theater and Normal.

SOUND

Press the SOUND key repeatedly, and you can choose among Memory, Speech, Music and Theater.

STEREO

In the Video mode, press the STEREO key to set Stereo to one of the R/L/On modes.

RECALL

This key will allow you to return to the last channel you were viewing. Pressing it again will return you to the channel you just left.

CC

Pressing the CC key will activate the currently selected Closed Captions or Text under the System Menu. Pressing it again will turn off the Closed Captions.

VIDEO

This key allows you to toggle between antenna and different video modes.

CHILD LOCK

The Child Lock feature prevents unauthorized viewing of the TV. To activate, press and hold the F key, and then press MUTE. You should see a key symbol appear on the screen. This will lock out all remote functions (except for Standby). To unlock the TV, press and hold the F key and press MUTE. This will unlock the TV. Please note that the only way to activate or deactivate the Child Lock feature is via remote control - please insure that it is stored securely.

0-9/100+

Press the 0-9 and 100+ keys to enter channel numbers directly (2-69 in the Air mode or 1-125 in the Cable mode).

- 1.To choose a one-digit channel number, press the 0 key, then press another Channel Number key to select a desired number.
- 2.To choose a two-digit channel number, enter a first-digit and then a second digit.
- 3.To choose a three-digit channel number, press the 100+ key so that 1- - appears on the screen, then enter the next digit one and two.

TROUBLESHOOTING GUIDE

Check the following guide for a possible correction to a problem before contacting customer service.
 Check FAQ at our website: www.apexdigitalinc.com.

Symptoms	Correction
No power	<ul style="list-style-type: none"> • Verify the power cables plug into an outlet with power.
No picture	<ul style="list-style-type: none"> • Verify the connection from the DVD/VCR video output to the TV video input is secure. Then switch TV to the appropriate Video mode. • Verify an antenna cable is securely connected to the RF in jack.
No sound	<ul style="list-style-type: none"> • Connect the audio cables into the terminals securely. • Verify the connection from the DVD/VCR audio output to the TV audio input. Then switch to the appropriate mode on the receiver. Refer to your audio amplifier owner's manual. • Verify the volume is at an appropriate level and the mute feature is not on.
No TV signal	<ul style="list-style-type: none"> • Verify the TV is set to Antenna mode. • Make sure the antenna is securely connected to the RF in jack. Unplug the TV from the wall for 30 seconds, then plug in and try again. Unplug the antenna connection from the back of the TV, unplug the TV from the wall, wait 30 seconds, then try again.
Stripe or purple interference appears in the screen.	<ul style="list-style-type: none"> • Verify the speakers around the TV set are shielded.
Picture becomes snowy.	<ul style="list-style-type: none"> • Verify the antenna lead wire is in working condition. • Verify the antenna is connected securely to the RF in jack.
Picture with multi-image	<ul style="list-style-type: none"> • Move the antenna around to minimize multi-images.
TV channel not received	<ul style="list-style-type: none"> • Make sure the Air/Cable setting is correct. • Channel may be locked with the block channel feature, such as Parental Control. • Check Add/Erase feature, as channel may have been erased during set up.
Black box appears on screen.	<ul style="list-style-type: none"> • Verify Closed Caption feature is off.
Remote control doesn't operate.	<ul style="list-style-type: none"> • Batteries may be weak. Replace batteries. • Make sure nothing is in between the remote and the remote sensor.

LIMITED UNITED STATES WARRANTY (AT2408S, AT2708S)

Apex Digital, Inc. makes the following limited warranties. These limited warranties extend to the original consumer purchaser or any person receiving this product as a gift from the original consumer purchaser and to no other purchaser or transferee.

Limited Ninety (90) Days Warranty

Apex Digital, Inc. warrants this product and its parts against defects in material or workmanship for a period of ninety (90) days after the date of original retail purchase. During this period Apex Digital, Inc. will repair or replace a defective part or product at their option, with a new or refurbished part or product, without charge to you. You must deliver the entire product to an Authorized Apex Digital, Inc. Service Center. You are responsible for all packing, transportation and insurance charges for the set to and from the Service Center.

Limited One (1) Year Warranty

Apex Digital, Inc. further warrants the parts in this product against defects in material or workmanship for a period of one (1) year after the date of original retail purchase with exception of the remote control which is guaranteed for ninety (90) days. During this period Apex Digital, Inc. will replace a defective part with a new or refurbished part without charge to you, except that if a defective part is replaced after ninety (90) days from the date of original retail purchase, you are responsible to pay all labor charges involved in the part(s) replacement. You must also deliver the entire product to an Apex Digital, Inc. Authorized Service Center. You are responsible for all packing, transportation and insurance charges for the set to and from the Service Center.

Rental Product

The warranty for a rental product begins with the original date of receipt by the rental firm.

Your Responsibility

The above warranties are subject to the following conditions:

- **You must retain your bill of sale to provide proof of purchase.**
- **You must retain all packing materials for return shipment.**
- All warranty service of this product must be made by an Authorized Apex Digital, Inc. Service Center.
- These warranties are effective only if the product is purchased and operated in the U.S.A.
- Labor service charges for set installation, setup, adjustment of customer controls and installation or repair of any type of antenna or cable systems are not covered by this warranty. Reception problems caused by inadequate antenna or cable system are your responsibility.
- **Warranties extend only to defects in materials or workmanship as limited above and do not extend to any product or parts which have been lost or discarded by you or damage to product or parts caused by misuse, accident, damage caused by Acts of God, such as lightning or fluctuations in electrical power, improper installation, improper maintenance or use in violation of instructions furnished by us; or to product which has been modified or had the serial number removed, altered, defaced or rendered illegible.**

How to Obtain Warranty Service

If after following all the operating instructions in this manual and reading the TROUBLESHOOTING section you find that service is necessary:

1. Contact our Customer Service Center directly call 866 4 APEXINC (866 427 - 3946), Mon - Fri 8am - 5pm (Pacific Time).
2. After obtaining the requested information, you must present your receipt to the Authorized Service Center to obtain warranty service.
3. You must deliver the entire product to the Authorized Service Center. You are responsible for all transportation for the product to and from the Service Center.

Limitations

All warranties implied by state law, including the implied warranties of merchantability and fitness for a particular purpose, are expressly limited to the duration of the limited warranties as set forth above. With the exception of any warranties implied by state law as hereby limited, the foregoing warranty is exclusive and in lieu of all other warranties, guarantees, agreements and similar obligations of manufacturers or seller with respect to the repair or replacement of any parts. In no event shall Apex Digital, Inc. be liable for consequential or incidental damages.

No person, agent, distributor, dealer or company is authorized to change, modify or extend the terms of these warranties in any manner whatsoever. The time within which action must be commenced to enforce any obligation of Apex Digital, Inc. arising under this warranty or under any statute, or law of the United States or any state thereof, is hereby limited to ninety (90) days from the date you discover or should have discovered the defect. This limitation does not apply to implied warranties arising under state law.

This warranty gives you specific rights and you may also have these rights which may vary from state to state. Some states do not allow limitation on how long an implied warranty lasts, when an action may be brought, or the exclusion or limitation of incidental or consequential damages, so the above provisions may not apply to you.

APEX Digital, Inc.
2919 E. Philadelphia Avenue
Ontario, California 91761
909-930-1239

FOR SERVICE CALL: 866-4-APEX-INC

Free Manuals Download Website

<http://myh66.com>

<http://usermanuals.us>

<http://www.somanuals.com>

<http://www.4manuals.cc>

<http://www.manual-lib.com>

<http://www.404manual.com>

<http://www.luxmanual.com>

<http://aubethermostatmanual.com>

Golf course search by state

<http://golfingnear.com>

Email search by domain

<http://emailbydomain.com>

Auto manuals search

<http://auto.somanuals.com>

TV manuals search

<http://tv.somanuals.com>