

Limited Warranty



DVD PLAYER

90 DAYS LABOR

ONE YEAR REPLACEMENT OF PARTS

WHO IS COVERED?

A proof of purchase is required to receive warranty service. A sales receipt or other document showing original date of purchase is considered proof of purchase.

WHAT IS COVERED?

Warranty repair is one (1) year limited warranty coverage:

- 90 days from original date of purchase:
 - Parts and labor are included under warranty repair.
- After 90 days up to one (1) year from original date of purchase.
 - Parts usage will be cover under warranty.
 - Labor will be charged at a flat rate.

NOTE: If you don't have proof of purchase, then your unit will be considered out-of-warranty. Out-of-warranty repairs will be charged at a flat labor rate, including any necessary parts.

WHAT IS EXCLUDED?

Your warranty does not cover:

- Labor charges for installation or setup of the product, adjustment of customer controls on the product, and installation or repair of antenna systems outside of the product.
- Product repair and/or part replacement because of misuse, accident, unauthorized repair or other cause not within the control of Apex Digital, Inc.
- A product that requires modification or adaptation to enable it to operate in any country other than the country for which it was designed, manufactured, approved and/or authorized, or repair of products damaged by these modifications.
- Incidental or consequential damages resulting from the product. (Some states do not allow the incidental or consequential damages, so the above exclusion may not apply to you. This includes, but is not limited to, prerecorded material, whether copyrighted or not copyrighted.)

MAKE SURE YOU KEEP:

Please keep your sales receipt or other document showing proof of purchase. Attach it to this owner's manual and keep both nearby. Also keep the original box and packing material in case you need to return your product.

BEFORE REQUESTING SERVICE:

Please check your owner's manual before requesting service. Adjustments of the controls discussed there may save you a service call.

REMEMBER

Keep a record of your model and serial number.

MODEL # _____ SERIAL # _____

WHERE IS SERVICE AVAILABLE?

Please contact: APEX DIGITAL, INC.
2919 E. Philadelphia St., Ontario, CA 91761
(909) 930-1239
customerservice@apexdigitalinc.com

This warranty gives you specific legal rights. You may have other rights which vary from state/province to state/province. We reserve the rights to change the manual without further notice.

DISCS AND OUTPUT SOUNDS

Sound recording system	DVD Video Discs							VCD	CD
	Dolby Digital		MPEG 2		Linear PCM			MPEG/	PCM44.1kHz
Audio setting on the setting screen	SPDIF /RAW	SPDIF /RAW	SPDIF /RAW	SPDIF /PCM	SPDIF /RAW SPDIF /PCM	SPDIF /RAW	SPDIF /PCM	SPDIF /RAW SPDIF /PCM	SPDIF /RAW SPDIF /PCM
ANALOG AUDIO OUT jacks	—	o	—	o	—	o	o	—	o
DIGITAL AUDIO OUT jack	Dolby Digital bitstream	PCM (48kHz)	MPEG 2 bitstream	PCM (48kHz)	PCM (48kHz)	PCM (48kHz)	—	PCM (44.1kHz)	PCM (44.1kHz)

ON VIDEO CD

This DVD video player supports the VIDEO CD with PBC (Version 2.0) (PBC) is the abbreviation for Play Back Control.

You can enjoy two kinds of playbacks, depending on types of disc.

TYPE OF DISC	HOW TO ENJOY
VIDEO CD without PBC (VERSION 1.1)	Audio and movie can be played back by operating the unit in the same way as the audio CD.
VIDEO CD with PBC (VERSION 2.0)	In addition to the operation of the VIDEO CD without PBC, you can enjoy a playback with interactive software and software with search function by using the menu displayed on the TV screen (Menu Playback). Some of the functions described in this manual may not work in some discs.

Before Calling Service Personnel

Check the following guide for the possible cause of a problem before contacting service.

SYMPTOMS AND CORRECTION

Symptom	Cause	Correction
No power	<ul style="list-style-type: none"> The power plug is disconnected 	<ul style="list-style-type: none"> Connect the power plug into the wall outlet securely.
No picture	<ul style="list-style-type: none"> The TV is not set to receive DVD output The video cable is not connected securely 	<ul style="list-style-type: none"> Select the appropriate video input mode on the TV so the picture from the DVD video player appears on the TV screen. Connect the video cable into the jacks securely.
No sound	<ul style="list-style-type: none"> The equipment connected with the audio cable is not set to receive DVD signal output. The audio cables are not connected securely. The power of the equipment connected with the audio cable is turned off. The setting of output sound type is not correct. 	<ul style="list-style-type: none"> Select the correct input mode of the audio receiver so you can listen to the sound from the DVD video player. Connect the audio cable into the jacks securely. Turn on the equipment connected with the audio cable. Set the audio setting correctly.
The playback picture has occasional distortion	<ul style="list-style-type: none"> The disc is dirty. It is in fast forward reverse playback. 	<ul style="list-style-type: none"> Eject the disc and clean it. Sometimes a small amount of picture distortion may appear. This is not malfunction.
Brightness is unstable or noises are produced on playback pictures	<ul style="list-style-type: none"> The copy protection's effect. 	<ul style="list-style-type: none"> Connect the DVD video player to the TV directly.
The DVD video player does not start playback	<ul style="list-style-type: none"> No disc is inserted. An unplayable disc is inserted. The disc is placed upside down. The disc is not placed within the guide. The disc is dirty. A menu is on the TV screen. The parental lock function is set. 	<ul style="list-style-type: none"> Insert a disc. (Check that the DVD or VCD or audio CD indicator in the DVD displays is lit.) Insert a playback disc. (Check the disc type and color system). Place the disc with the playback side down. Place the disc on the disc tray correctly inside the guide. Clean the disc. Press the SETUP button to turn off the menu screen. Cancel the parental lock function or change the parental lock level. (<i>The Pre-set password is 3308.</i>)
Buttons do not work	<ul style="list-style-type: none"> Power supply fluctuations or other abnormalities such as static electricity may interrupt correct operations. 	<ul style="list-style-type: none"> Turn the power on or off with the POWER button. Or disconnect the power plug and insert it into the wall outlet again. Check each button on the remote, make sure it is in normal position.
The remote control does not work properly	<ul style="list-style-type: none"> The remote control is not pointed at the remote sensor of the DVD video player. The remote control is too far from the DVD video player. The batteries in the remote control are exhausted. 	<ul style="list-style-type: none"> Point the remote control at the remote sensor of the DVD video player (left side). Operate the remote control within about 7m. Replace the batteries with new ones.

Specifications

DVD VIDEO PLAYER/OUTPUTS/SUPPLIED ACCESSORIES

DVD VIDEO PLAYER

Power supply	120V AC 50 or 60 Hz
Power consumption	20VA
Mass	3.3 kg
External dimensions	430 x 81 x 300 mm (W/H/D)
Signal system	MULTI/NTSC/PAL
Laser	Semiconductor laser, wavelength 650 nm

OUTPUTS

Video output	1.0 V (p-p), 75 Ω , negative sync., pin jack x 1
S video output	(Y) 1.0 V (p-p), 75 Ω negative sync., Mini DIN 4-pin x 1 (C) 0.286 V (p-p), 75 Ω
Component video output	(Y) 1.0 V (p-p), 75 Ω negative sync., pin jack x 1 (Cr)/(Cb) 0.7 V (p-p), 75 Ω
Audio output (digital audio)	0.5 V (p-p), 75 Ω , pin jack x 1
Audio output (analog audio)	2.0 V (rms), 330 Ω , pin jack(L,R) x 1

SUPPLIED ACCESSORIES

Audio cable (red and white)	1 pair
Remote control	1
Batteries (AAA)	2
Video cable (yellow)	1
S-Video cable	1
Power cord	1

Notes on Discs

HOW TO HANDLE, CLEAN, AND STORE DISCS.

HANDLING DISCS

- Do not touch the playback side of the disc.
- Do not attach paper or tape to discs.



CLEANING DISCS

- Fingerprints and dust on the disc cause picture and sound deterioration. Wipe the disc from the center outward with a soft cloth. Always keep the disc clean.
- If you cannot wipe off the dust with a soft cloth, wipe the disc lightly with a slightly moistened soft cloth and finish with a dry cloth.
- Do not use any type of solvent such as a thinner, benzene, commercially available cleaners or anti-static spray for vinyl LP's. It may damage the disc.

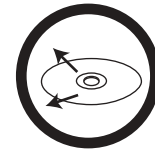



STORING DISCS

- Do not store discs in places subject to direct sunlight or near heat sources.
- Do not store discs in places subject to moisture and dust such as a bathroom or near a humidifier.
- Store discs vertically in a case. Stacking or placing objects on discs outside of their case may cause warping.

ABOUT THIS OWNER'S MANUAL



This owner's manual explains the basic instructions of this DVD video player. Some DVD video discs are produced in a manner that allows specific or limited operation during playback. As such, the DVD video player may not respond to all operating commands. Refer to instruction notes of disc.

“” may appear on TV screen during operation.



“” means that the operation is not permitted by the DVD video player.

PLAYABLE DISCS

This DVD video player can play back the following discs.

	Disk Mark	Contains	Disc Size	Maximum playback time
DVD video disc		Audio + Video (moving pictures)	12 cm	Approx. 4 hours (single sided disc)
				Approx. 8 hours (double sided disc)
Video CD		Audio + Video (moving pictures)	12 cm	Approx. 74 minutes
			8 cm	Approx. 20 minutes
Audio CD		Audio	12 cm	Approx. 74 minutes
			8 cm (CD single)	Approx. 20 minutes

NOTES ON REGIONAL NUMBERS

The region number of this DVD video player is 1. If region numbers, which stand for their playable area, are printed on your DVD video disc, make sure the disc plays region  or . Otherwise playback will not be allowed by the player (In this case, the DVD video player will display the message.)

TYPE OF TV SYSTEM

Connect this DVD video player to a TV compatible with PAL/3.58 NTSC system.

Customizing the Function Settings

THIS DVD VIDEO PLAYER ALLOWS YOU TO CUSTOMIZE THE PERFORMANCE TO YOUR PERSONAL PREFERENCES.

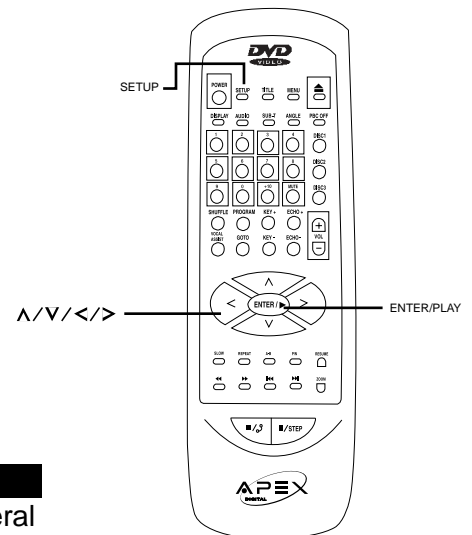
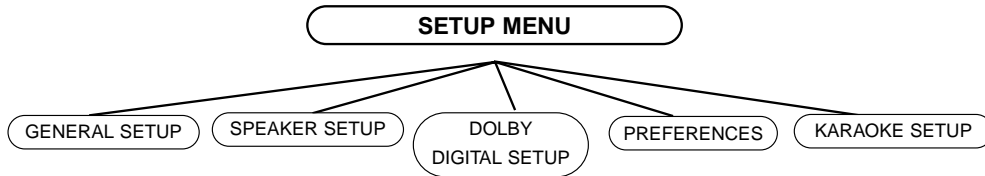

DISPLAYING THE SETUP MENU SCREEN

The SETUP MENU screen asks you to select a setting category from General Setup, Speaker Setup, Dolby Digital Setup, Karaoke setup and Preferences. The selected category will provide you the setting details using the succeeding screen.

1. Press SETUP.

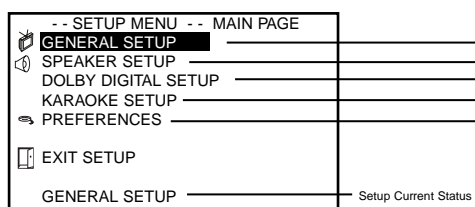
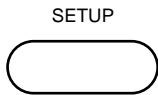

2. Press $\Delta/V/\langle/\rangle$ to select category (highlight), then press PLAY/ENTER.

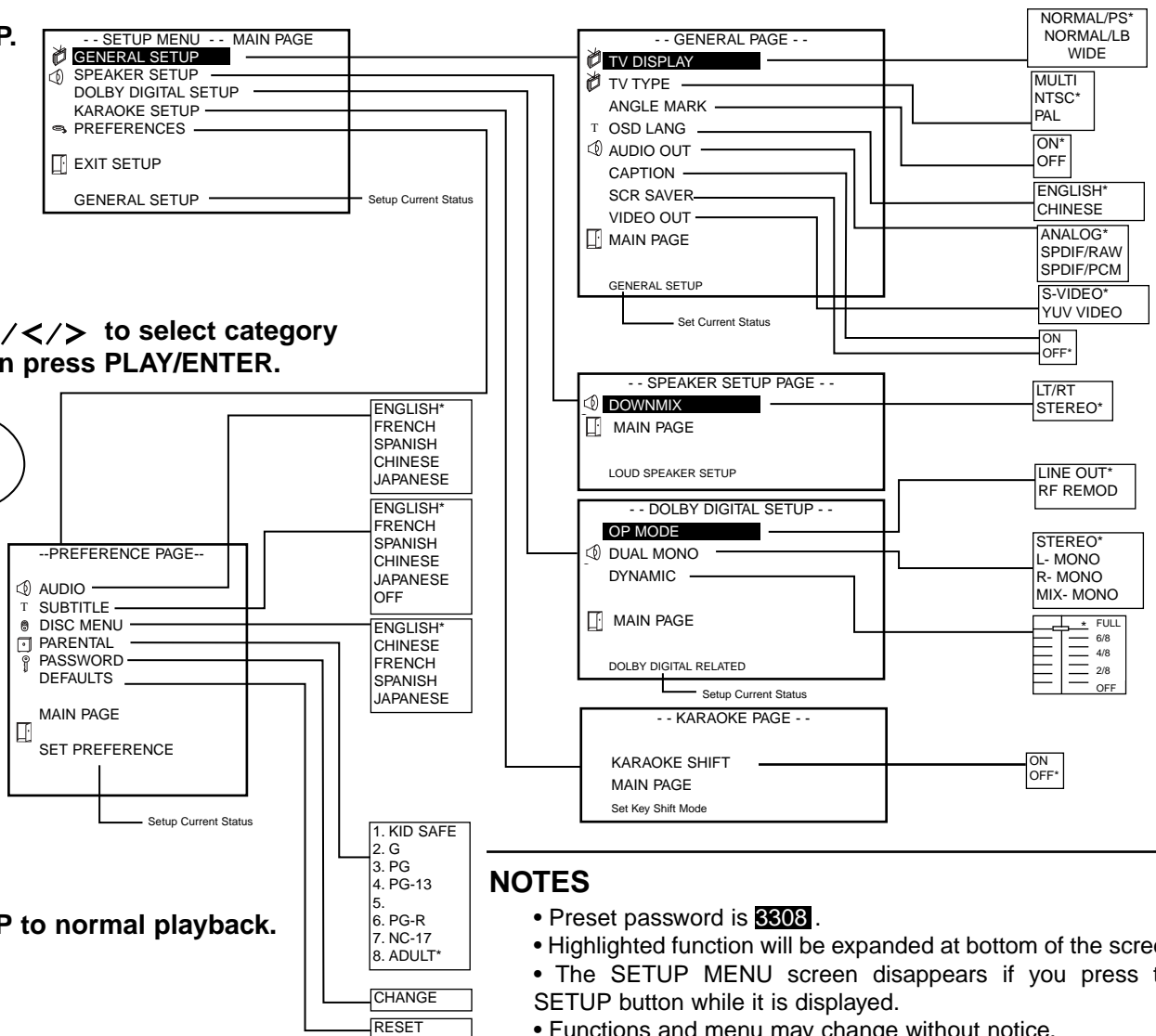
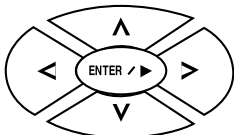

3. Press SETUP to normal playback.

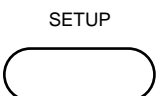

NOTES

- Preset password is **3308**.
- Highlighted function will be expanded at bottom of the screen.
- The SETUP MENU screen disappears if you press the SETUP button while it is displayed.
- Functions and menu may change without notice.
- * Factory defaults
- ** You must press STOP to set up PREFERENCES.

Setting the Parental Lock

YOU CAN USE THE PARENTAL LOCK FUNCTION ONLY WITH DVD VIDEO DISCS EQUIPPED WITH THE PARENTAL LOCK FEATURE.

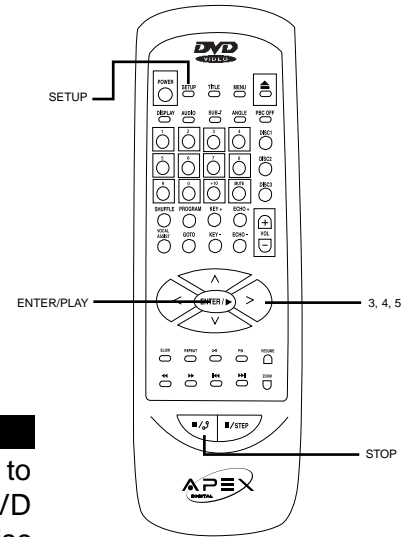
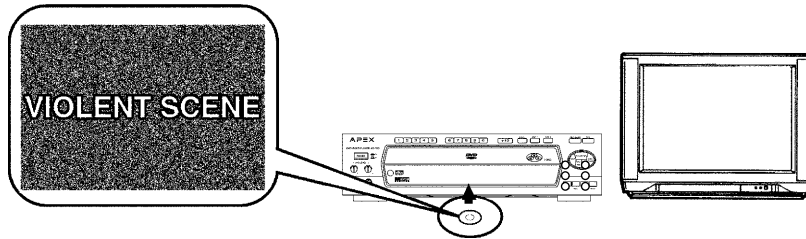

SETTING THE PARENTAL LOCK

DVD video discs equipped with the parental lock function are rated according to their content. The contents allowed by a parental lock level and the way a DVD video disc can be controlled may vary from disc to disc. For example, if the disc allowed, you could edit out violent scenes unsuitable for children and replace them with more suitable scenes, or lock out playback of the disc all together.

1. Press STOP during playback

Press STOP once.



2. Press SETUP

The SETUP MENU appears on the TV screen.

SETUP

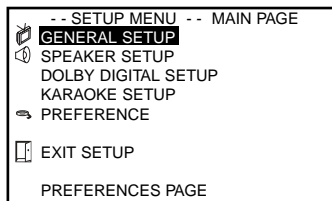
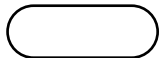

3. Select PREFERENCE, press ENTER.

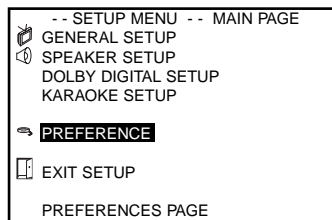
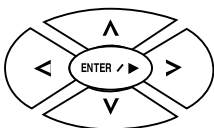

4. Select PARENTAL, press ENTER

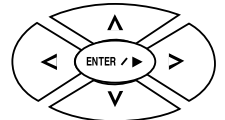
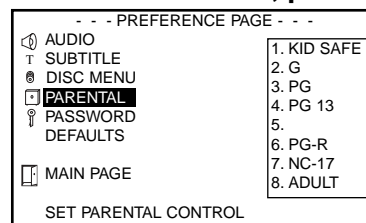

5. Select ratings, press ENTER/PLAY

6. Enter your password then press ENTER/PLAY The pre-set password is **3308**

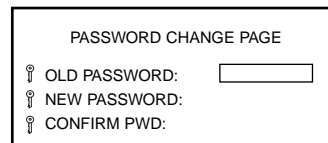

SETUP



7. Press SETUP to exit setup, press PLAY to start

TO CHANGE YOUR PASSWORD:

1. Follow step 4 to select password change.
2. Enter old password.
3. Enter new password.
4. Re-enter to confirm your new password.
5. Press ENTER.
6. Press SETUP.

Using the On-Screen Display

THIS DVD VIDEO PLAYER ALLOWS YOU TO VIEW THE STATUS AND DISC INFORMATION ON TO YOUR TV SCREEN.

CHECKING THE OPERATIONAL STATUS

With this function, you can view on your TV, the following:

- Current title
- Track number
- Total playing time

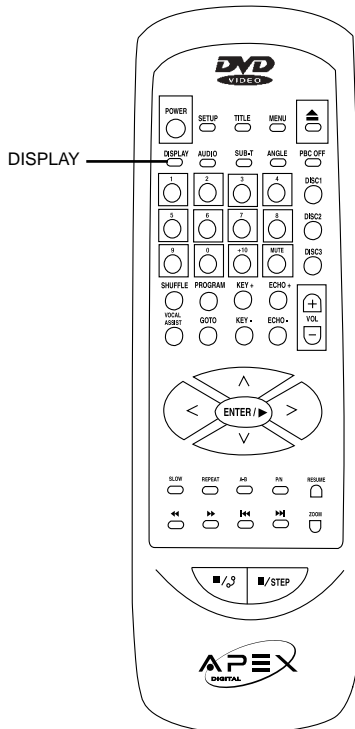

DISPLAY

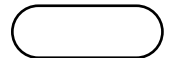

Press DISPLAY during playback.

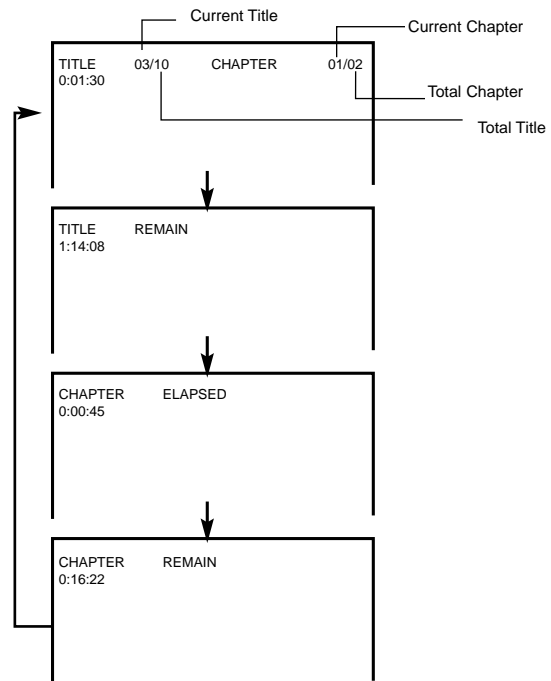

Total playing time of the disc is displayed in the DVD display.

TO TURN OFF THE ON-SCREEN DISPLAY

Press DISPLAY Again.

DISPLAY



FUNCTIONS AVAILABLE IN THIS UNIT (SET WITH KARAOKE ON)

DVD video	VIDEO CD
<ul style="list-style-type: none"> Echo adjustment Key adjustment 	<ul style="list-style-type: none"> Echo adjustment Key adjustment
<ul style="list-style-type: none"> Sound selection 	<ul style="list-style-type: none"> Sound selection of left and right channel Vocal cancel* Vocal change*

***Vocal cancel:**

Eliminates the vocal sound centered from the sound stereo-recorded in a VIDEO CD.

***Vocal change:**

When your vocal is entered through the microphone, the vocal part recorded in sound-multiplex is eliminated and your vocal will be heard.

*** For DVD Karaoke disc:**

Press "AUDIO" for sound selection.

*** For VCD Karaoke disc:**

Press "VOCAL ASSIST" for sound selection.

*** For DVD, VCD Karaoke disc:**

Press "MUTE" to eliminate sound and vocal. Keep the microphone on.

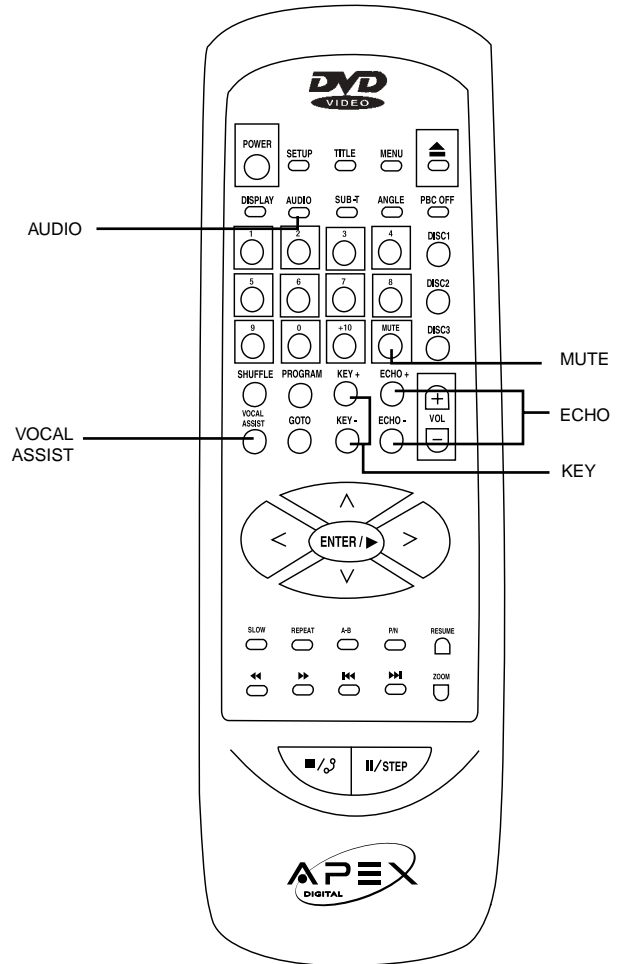

- The vocal cancel function may not work in some discs.
- The vocal change function works with a disc recorded in sound-multiplex.

THIS DVD VIDEO PLAYER ALLOWS YOU TO ENJOY KARAOKE WITH ONE OR TWO MICROPHONES



HOW TO SETUP THE KARAOKE

Make sure that the Karaoke discs are either a VCD Karaoke or a DVD Karaoke disc. These are the only two compatible formats that this DVD video player will recognize.

Note: The microphone audio output is analog and will only produce audio from the **Mixed Audio** section of the audio output on the back of the DVD player.

1. Connect the microphone to MIC 1 or/and MIC 2.

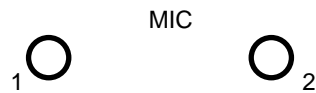

2. Adjust the MIC level and ECHO level.

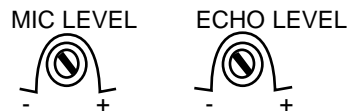

How to adjust the sound level of the Microphone(s):

Using the MIC LEVEL on the front panel of the DVD video player, adjust the knob of MIC LEVEL until your sound level of preference.

How to adjust the ECHO LEVEL/KEY LEVEL:

For echo, using the ECHO LEVEL on the front panel of the DVD video player, adjust the knob of ECHO LEVEL until your sound level of preference. For key, press KEY+/KEY- on remote control unit to adjust the key level.

NOTICE

- While you are in the Karaoke mode and experience a (Pi!) sound, please try the following:
 - Keep the microphone(s) away from any speakers.
 - Lower the sound level of the microphone.
 - Lower the sound level volume of the speaker .
- The karaoke function will stay on unless you follow the proper steps to turn the karaoke off.

Selecting Subtitles

THIS DVD VIDEO PLAYER ALLOWS YOU TO DISPLAY THE SUBTITLES FROM THOSE INCLUDED ON THE DISC, ON TO YOUR TV SCREEN.

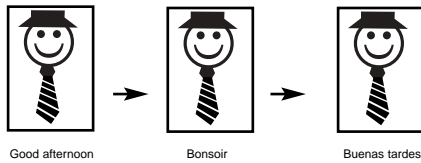

HOW TO DISPLAY SUBTITLES

You have the option to select a preferred subtitle from those included on the DVD video disc.

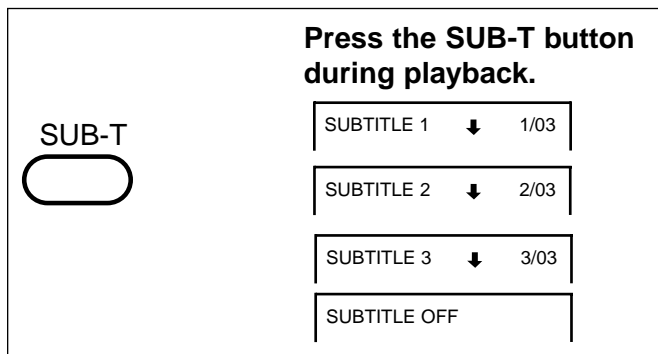

To **TURN OFF** the subtitles.

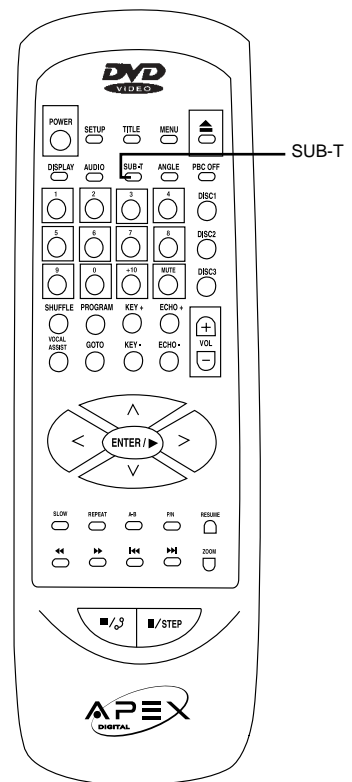
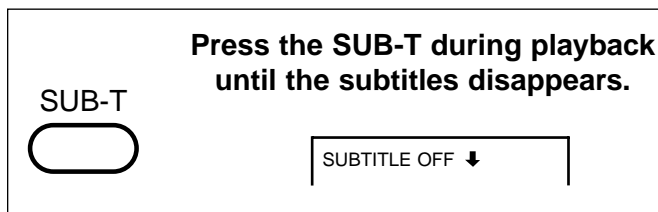

NOTICE

- Due to the nature of some DVD video discs, you may not be able to turn off the subtitles and they will appear on screen automatically.
- As you press the SUB-T button, the subtitles may not appear immediately during some scenes.
- If the subtitles continue to show on your TV even after the DVD has been turned off, please refer to the TV's close caption settings.

Playing in a Favorite Order

THIS DVD VIDEO PLAYER ALLOWS YOU TO PROGRAM UP TO 99 ITEMS INTO THE MEMORY AND THEN PLAY THEM BACK IN ANY ORDER. YOU HAVE THE OPTION TO COMBINE YOUR FAVORITE, TITLES, CHAPTERS OR TRACKS AND PLAY THEM BACK THE WAY YOU WANT IT PLAYED BACK. (PROGRAM PLAYBACK)

HOW TO SET TITLES, CHAPTERS, OR TRACKS IN A FAVORITE ORDER

The program playback function will automatically playback titles, chapters, or tracks in the order preprogrammed.

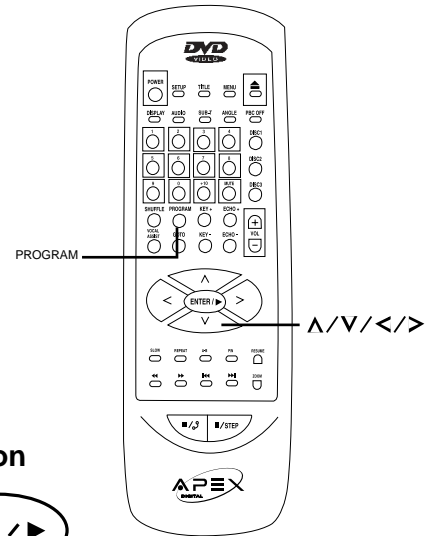

1. Insert a disc, turn PBC OFF then press the PROGRAM button.



At this time, the menu will appear.



2. Using the numbered button, select the items you want in the order you want them programmed in.

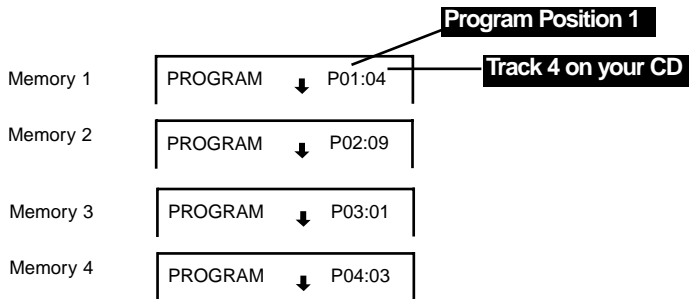

To reset program, press CLEAR.



3. Press the PLAY button

The DVD video player starts memory playback.



To CHANGE the programmed item:
Press the STOP button, then follow step 1.

To CANCEL the programmed item:
Press the STOP button, then press the PLAY button.

To RESUME NORMAL PLAYBACK from memory playback
Press the PBC OFF button during stop. The MEMORY indicator will disappear.

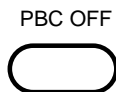

About the +10 Key:

To select tracks 10 and above, use the “+10” key and additional numbered keys to go the sum of the keys chosen position.

Example: go to track 12, press the “+10” Key and the number 2 Key to equal 12. To go to track 20, press the “+10” Key twice and so on. You can program up to 99 items into the memory.

NOTICE

- When the DVD video player is turned off, or if the discs are removed, the program item will be removed.
- Depending on the disc, the program playback may not function.

Selecting the Camera Angle/Selecting a Language

THIS DVD VIDEO PLAYER ALLOWS YOU TO SELECT FROM SEVERAL DIFFERENT ANGLES AND LANGUAGES.

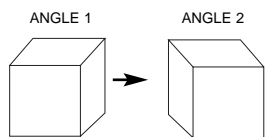

Selecting the camera angle

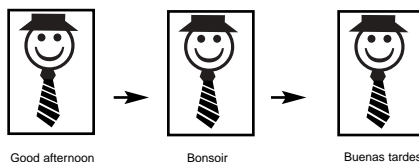

Selecting a language

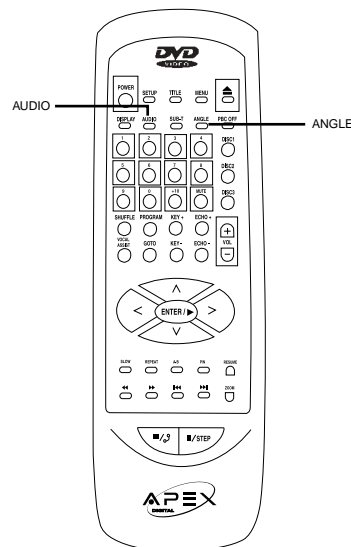

HOW TO CHANGE THE CAMERA ANGLE

If the DVD video disc was recorded from multiple angles, you have the option to change the camera angle of the scene you are watching.

Press the ANGLE button while playing back a scene recorded with multiple angles.

- You may only press the ANGLE button when the angle icon  is flashing on the DVD display.
- Each time you press the ANGLE button, the angle will change.

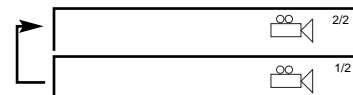
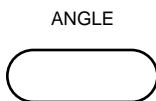

NOTICE

- The angle function will not work on DVD video discs that does not contains recorded multiple angles.
- During still playback, you are able to change the camera angle. However, when you resume to normal playback, the camera angle changes to the new settings.
- The angle icon indicator will illuminate while playing back a title that contains at least one scene recorded from multiple angles.

HOW TO SELECT A PLAYBACK AUDIO SETTING

This DVD video player allows you to select a preferred language and sound recording system from those included on the DVD video disc.

1. Press the AUDIO button during playback

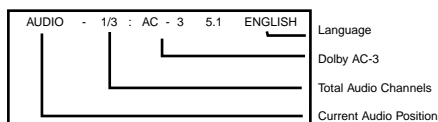

2. Press the AUDIO button again to cycle backwards

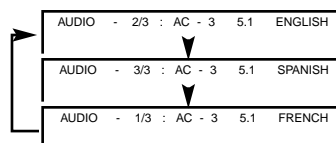

Recording systems

This DVD video player uses the Dolby Digital/AC-3, MPEG 2, PCM and DTS recording systems. It cannot playback DVD video discs recorded in any other recording system.

NOTICE

- The player returns to the initial default settings, when you turn on the DVD video player or replace a disc.
- The DVD video player plays a prior sound programmed on the disc, when you select a sound which is not included on the disc.

Zooming a Picture

ZOOMING A PICTURE

This DVD video player allows you to zoom into a picture as well as shift the zoom point.

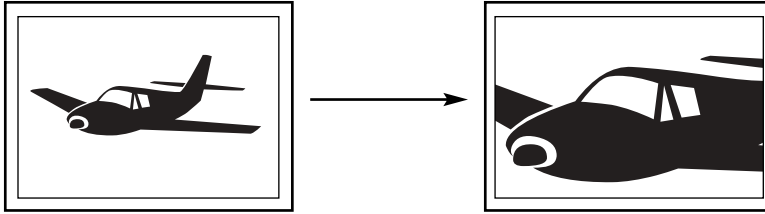

Press ZOOM during normal playback or slow-motion.
The DVD video player magnifies in the center of the picture.

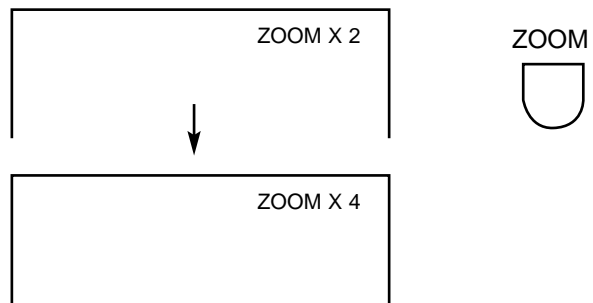
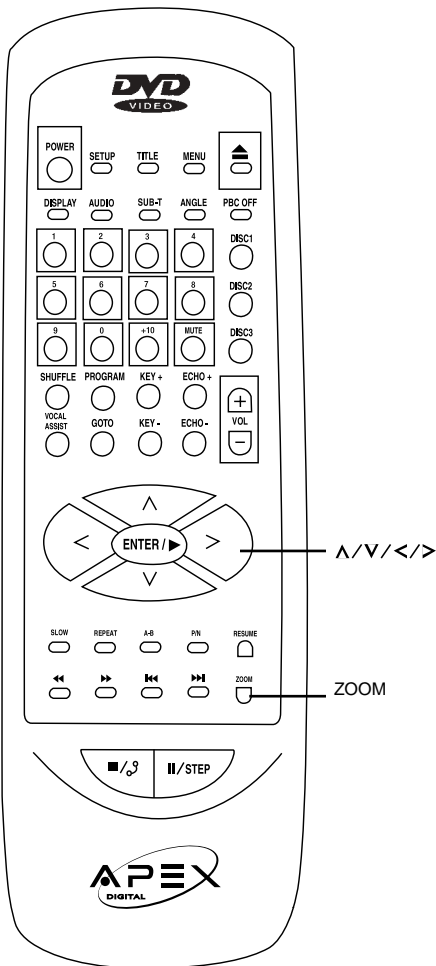

If you press $\wedge/\vee/\lt;/\gt$ during zoom playback, the zoom point shifts.

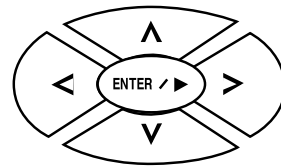

TO RESUME NORMAL PLAYBACK.
Press ZOOM during zoom playback.



Playing in Random Order

THIS DVD VIDEO PLAYER ALLOWS YOU TO PLAYBACK TITLES, CHAPTERS WITHIN A TITLE, OR TRACKS IN RANDOM ORDER. (RANDOM PLAYBACK)

PLAYING TITLES IN RANDOM ORDER

This DVD video player will automatically choose the titles in a DVD video disc and play them back randomly.

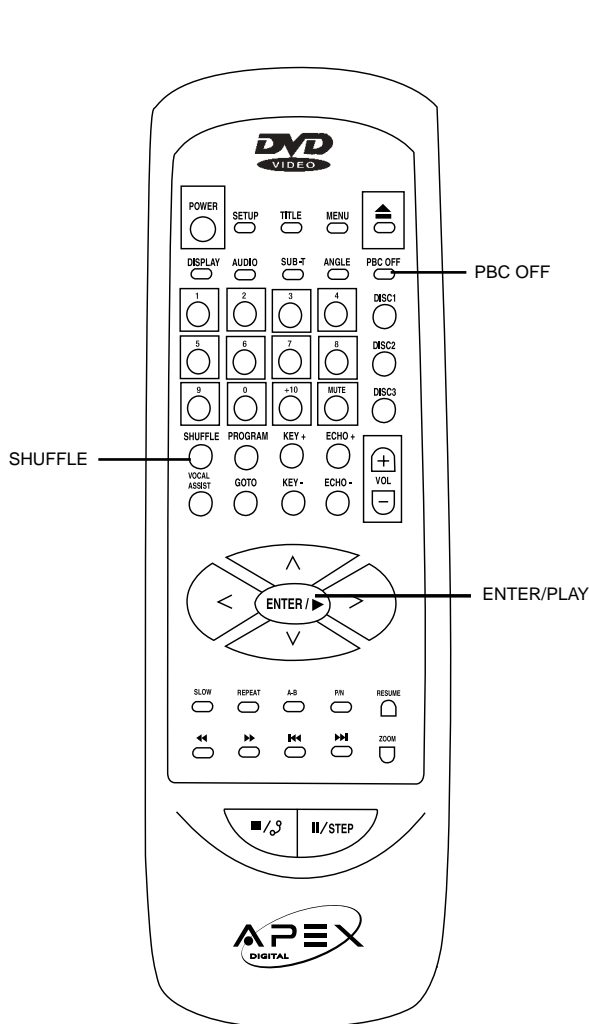

1. Press the PBC OFF button

PBC OFF



2. Press the SHUFFLE button during stop

SHUFFLE



3. Press the ENTER/PLAY button

The DVD video player will now start random playback.



NOTICE

You must press the ENTER/PLAY button within 5 seconds after you press the SHUFFLE button.

TO RESUME NORMAL PLAYBACK.

Press PBC OFF during stop, then press ENTER/PLAY.

PBC OFF



ENTER / PLAY



NOTICE

- While you are stopped the random playback function, it will not operate with the memory playback function.
- In order for this function to work, the PBC must be turned off.
- The DVD video player will go to another chapter or track and start playback, if you press the SKIP ►► button during random playback.

Playing Repeatedly

THIS DVD VIDEO PLAYER ALLOWS YOU TO PLAYBACK A SPECIFIC TITLE, CHAPTER, TRACK, OR SEGMENT REPEATEDLY. (TITLE REPEAT, CHAPTER/TRACK REPEAT, A-B REPEAT)

HOW TO REPEAT A TITLE, CHAPTER, OR TRACK

1. Select the title, chapter, or track you want to repeat

2. Press the REPEAT button

The repeat mode changes, each time you press the REPEAT button.

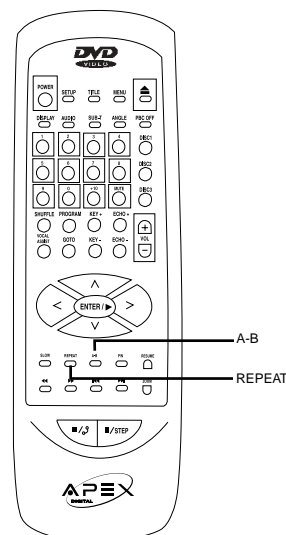
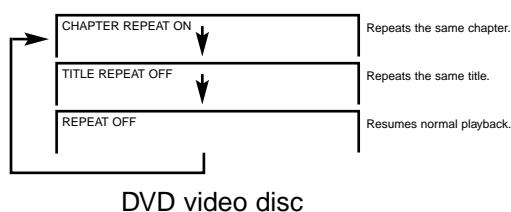
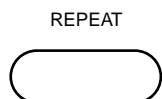

HOW TO REPEAT A SPECIFIC SEGMENT

1. Press the A-B button at the beginning of the segment in which you want to repeat playback (point A)

2. Press the A-B button again at the end of the segment (point B)

The DVD video player will automatically return to point A and start to repeat playback of the selected segment (A-B).

3. Press the A-B button to cancel the A-B repeat function

The DVD video player will resume to normal playback.

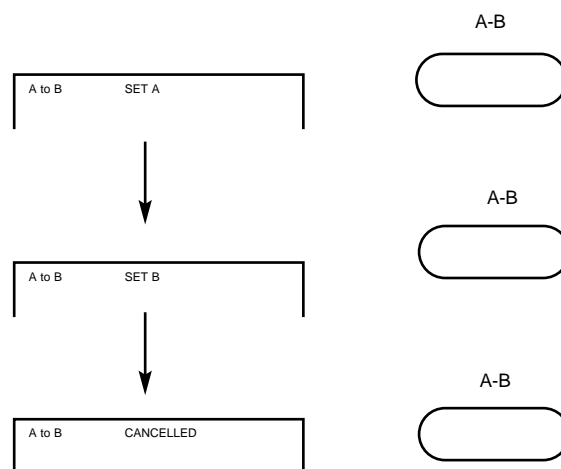

NOTICE

- Depending on the disc, you may experience a difference between point A and the location where playback actually resumes.
- If a segment allows for multiple camera angles, you can not set the A-B repeat function.
- Be aware that some discs will not respond to the A-B repeat function.
- CD does not have this feature.

VIEW INDIVIDUAL CHAPTERS

If the DVD video disc contains different chapters, you can locate a specific chapter.

1. Press PBC OFF

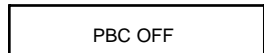

PBC OFF

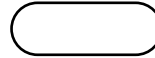

2. Press DVD DIGEST

The player plays each individual chapters.

DVD DIGEST

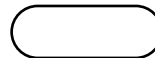

3. Press ►► to show the rest of the chapters



4. Select chapter by numbers

The DVD player start to play selected chapter.

- Return to normal playback, Press PBC OFF again.
- Digest only displays 9 chapters each time.
- Some disc you may stop playback, then press PBC off.

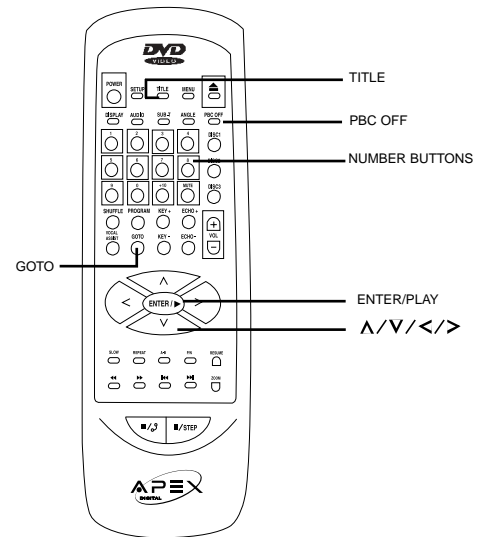
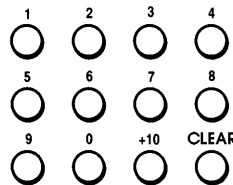

LOCATING A TITLE

If a DVD video disc contains title numbers, you can locate a specific title by directly selecting a title number.

1. Press GOTO during playback

Make sure that the space next to TITLE is highlighted.

GOTO



2. Press numbers to select the title and chapter you want

e.g. To select title 2

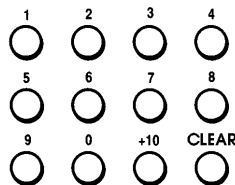

TITLE: 02 /02 CHAPTER: 03/03

3. Press ENTER

The DVD video player starts playback from chapter 3 of the selected title 2.

To select title 22:

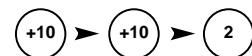

NOTICE

- By pressing ▲/▼/◀/▶ you may shift the highlights between the TITLE and CHAPTERS.
- In order to access the GOTO function on some disc, you must first press the PBC OFF.
- To select the time, you can press the GOTO twice.
- From the SETUP menu you may choose a preferred language.

Locating a Specific Title, Chapter or Track

THE DVD VIDEO DISCS ARE NORMALLY DIVIDED INTO TITLES. THE TITLES ARE SUB-DIVIDED INTO CHAPTERS. MOREOVER, VIDEO CD, AUDIO CD and MP3 CD ARE DIVIDED INTO TRACKS. YOU CAN CONVENIENTLY LOCATE ANY SPECIFIC TITLE, CHAPTER, OR TRACK WITH THIS DVD VIDEO PLAYER.

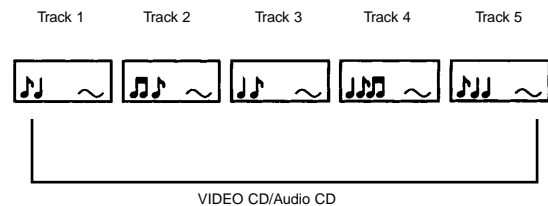
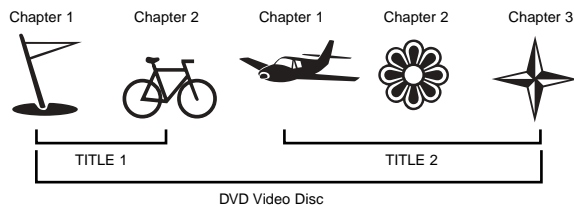

LOCATING A TITLE USING THE TITLE MENU

You can locate a specific title using the title menu function, if a DVD video disc contains a title menu.

1. Press the TITLE button

On the TV screen, the title menu will appear.

2. Press the $\wedge/\vee/\leftarrow/\rightarrow$ button to select the title you want

You can also directly locate a specific title by pressing its assigned number with the number buttons.

3. Press the ENTER button

This will cause the DVD video player to start playback from chapter 1 of the title selected.

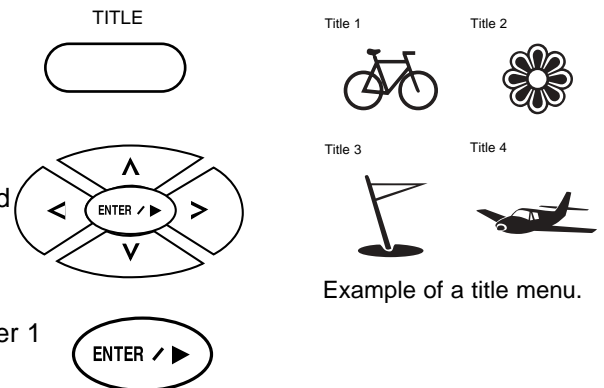

NOTICE

- You may experience that some discs will not respond to this function.
- If different instructions appear on the TV screen, follow those instructions. The instructions above are describing the basic procedure where the procedures may vary depending on the contents of the DVD video disc.

LOCATING A SPECIFIC CHAPTER OR TRACK

This DVD video player allows you to locate consecutive chapters or tracks.

Press the SKIP \lll or \ggg button repeatedly to display the requested chapter or track

The DVD video player starts playback from the selected chapter or track.



How to locate proceeding chapters or tracks

- When you press the SKIP \lll button, the DVD video player starts playback from the beginning of the proceeding chapter or track.

How to locate succeeding chapters or tracks

- When you press the SKIP \ggg button, the DVD video player starts playback from the beginning of the succeeding chapter or track.

Notice: On some discs the titles may not display the sub-divided chapters.

PLAYING IN SLOW-MOTION

A disc can also be played back in slow-motion.

TV SCREEN (FORWARD)

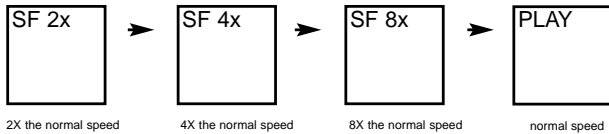

TV SCREEN (REVERSE)

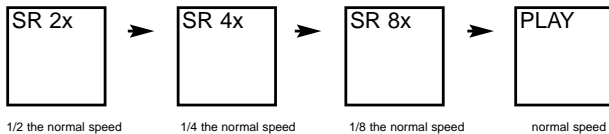

Press the SLOW button during playback

The playback speed becomes 1/2, 1/4, or 1/8 of the normal speed each time you press the SLOW button.
(Reverse slow play as the same.)

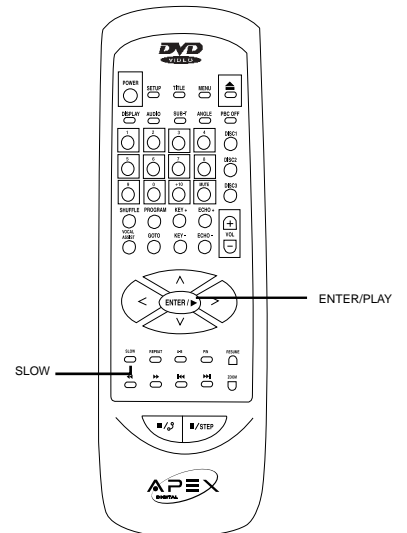

NOTICE

- During the slow-motion playback, the sound is muted.
- CD does not have this feature.

TO RESUME NORMAL PLAYBACK.
Press ENTER/PLAY.



RESUMING PLAYBACK FROM THE SAME LOCATION

This DVD video player allows you to stop playback and continue playback later from the same location on the disc.

1. Press the STOP button

This will interrupt the playback and the DVD video player will memorize the location where you stopped playback.

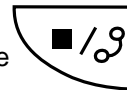

2. Press the ENTER/PLAY button

The DVD video player will resume the playback from the location where you stopped playback.

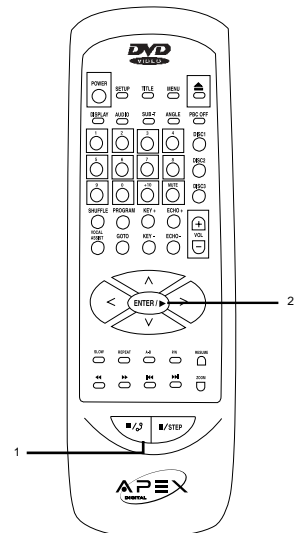

NOTICE

- The following will cancel the RESUME function:
 - Unplugging the DVD video player after you stop playback.
 - Ejecting the disc.
 - Adjusting/changing the parental lock or selecting a different language setting.
- On occasion depending on the disc, you may experience a difference of location where playback resumes.
- CD does not have this feature.

ADVANCED PLAYBACK

The DVD video player allows you to playback discs at various speeds. You may also resume playback from the location where you stopped playback.

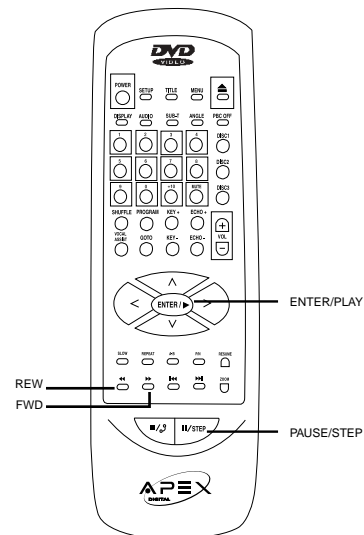
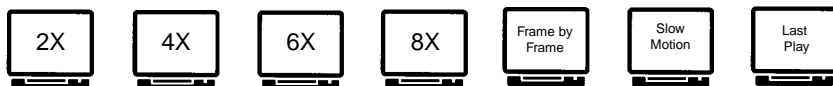

PLAYING AT 2X, 4X, 6X, OR 8X THE NORMAL SPEED

You can play back a disc at 2x, 4x, 6x, or 8x the normal speed.

Press the REW or FWD button during playback.

The playback speed becomes 2x the normal speed.

The playback speed changes, each time you press the REW or FWD button.

- ◀◀ REW: Fast reverse
- ▶▶ FWD: Fast forward

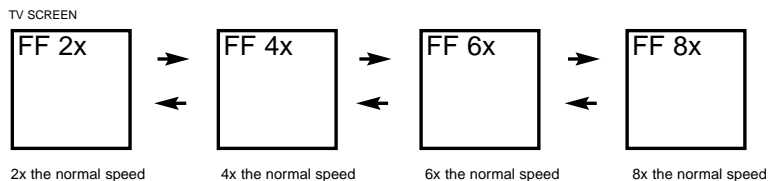

- Video CD, Audio CD

The rewind or forward playback alternates between 1x, 2x, 3x, 4x speed.

TO RESUME NORMAL PLAYBACK.
Press ENTER/PLAY.



NOTICE

- The DVD video player will not playback sound and subtitles during scan reverse and forward playback of DVD video discs. The DVD video player will play sound during fast forward or fast reverse playback of audio CDs.
- The speeds may vary slightly from disc to disc and the 2x, 4x, 6x, and 8x speeds are only approximate speeds.

PLAYING FRAME BY FRAME

Press the STEP button during playback.

The picture will advance one frame each time you press the STEP button.

STEP

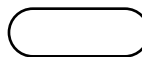

TO RESUME NORMAL PLAYBACK.
Press ENTER/PLAY.



NOTICE

- During frame by frame playback, the sound is muted.
- CD does not have this feature.

FOR A HIGHER QUALITY PICTURE

The DVD video discs produces a high resolution picture as well as contains a lot of information. This causes periodical picture noise on the TV during playback. The noise will vary depending on the selected TV used with this DVD video player. To control the picture noise reduce the sharpness adjustment on your TV when viewing DVD video discs.

ABOUT DVD VCD CD

On the heading bar the **DVD VCD CD** icons will appear depending on the disc being playedback.

- DVD:** DVD video discs
- VCD:** Video CDs
- CD:** Audio CDs

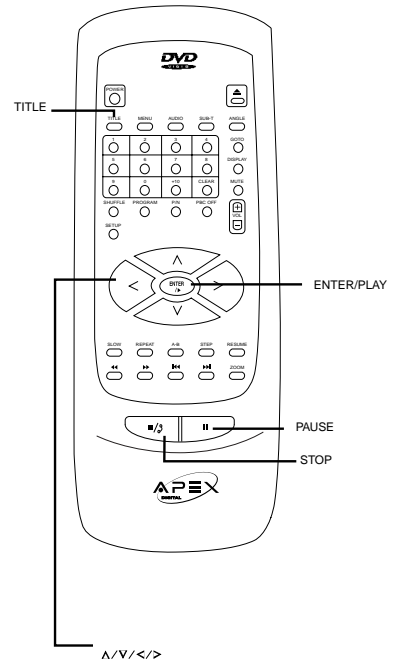

HOW TO START PLAYBACK FROM THE MENU SCREEN

1. Press **▲/▼/◀/▶** or the number buttons to select the title.

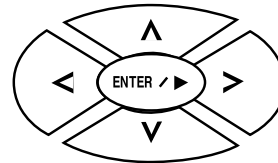

2. Press the **ENTER/PLAY** button.

The DVD video player will start playback from the title selected.

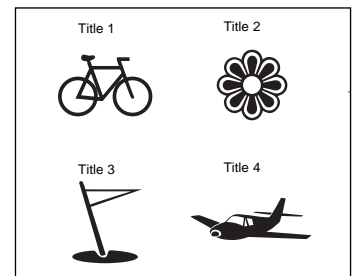

HOW TO PAUSE PLAYBACK (STILL PLAYBACK)

Press the **PAUSE** during playback.
 Press the **PAUSE** or **ENTER/PLAY** button to resume normal playback.
 During the still playback the sound is muted.



HOW TO REMOVE THE DISC

Press the **OPEN/CLOSE** button.
 Wait until the disc tray is completely open before removing any discs.
 After removing the discs, press the **OPEN/CLOSE** button to close the disc tray.



HOW TO STOP PLAYBACK

Press the **STOP** button.
 The DVD video player is stopped.
 Press the **ENTER/PLAY** button to replay.
 Press the **STOP** button twice.
 Press the **ENTER/PLAY** button.
 The DVD video player returns to chapter 1 or track 1.



NOTICE

At the completion of each movie a menu screen will appear. Be aware that the on-screen setup menu may damage your TV by permanently burning that image onto the screen. To avoid this, press the STOP button at the completion of each movie. You may also decide to setup the SCREEN SAVER.

Playing Back a Disc

HOW TO PLAYBACK A DISC.

Basic Playback (see page 10 -13 for connections details)

How to playback DVD video discs or VIDEO CDs

- Turn on the TV and choose the video input source which is connected to the DVD video player.

How to enjoy the sound from the audio system

- Turn on the audio system and choose the input source which is connected to the DVD video player.
- Set the playback picture size respectedly to the ratio of the connected TV via the SETUP MENU displays.
- Set the "AUDIO OUTPUT" to "ANALOG" via the SETUP MENU displays, if you do not have the necessary equipment to enjoy Dolby Digital (DTS) sound.

1. Press the POWER button displayed on the front panel.

The POWER indicator will illuminate red, as the DVD video player turns on.



2. Press the OPEN/CLOSE button.

This will open the disc tray.

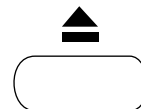

3. Place the disc on the disc tray.

Be sure the playback side is faced down.

4. Press ENTER/PLAY



After closing the disc tray playback will start.

As the DVD video player is reading the disc, a menu will appear on screen.

Notice

- A disc may be damaged if it is not correctly placed on the guides in the disc tray, this may also cause the DVD video player to malfunction.
- Do not force or place anything other than DVD video disc, VIDEO CD, audio CDs, or MP3 CD on the disc tray.

Notice

- The menu screen will appear automatically or you may access the menu screen by pressing the TITLE button.

NOTICE

- Moving the DVD video player during playback may cause damage to the disc as well as the player.
- To open and close the disc tray, you may only use the OPEN/CLOSE button on the remote control or DVD video player.
- Do not force or place anything other than DVD video disc, VIDEO CD, audio CD on the disc tray.

WARNING

DO NOT set "AUDIO OUTPUT" to "SPDIF/RAW" via the SETUP MENU displays, unless connecting (Via the PCM/DOLBY DIGITAL AUDIO OUT jack) a receiver that has the Dolby Digital/DTS decoding functions. Take precaution for high volume sounds may damage your speakers as well as your hearing.

Enjoying 2 Channel Digital Stereo Sound (BETTER)

2 Channel Digital Stereo

Enjoy the dynamic sound of 2 Channel Digital Stereo by connecting an amplifier equipped with a digital audio input and speaker system (right and left front speakers).

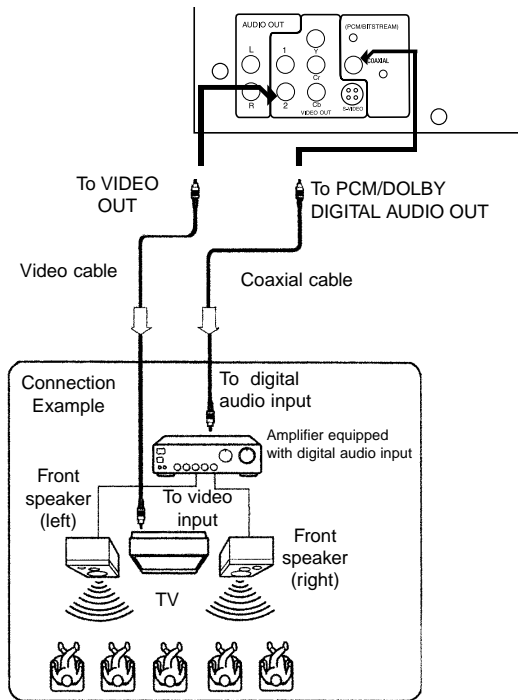

Set "AUDIO OUTPUT" to "SPDIF/PCM" via the setup menu.

Enjoying Dolby Pro Logic Surround Sound (GOOD)

Dolby Pro Logic Surround

Enjoy the dynamic realistic sound of Dolby Pro Logic Surround by connecting an amplifier and speaker system (right and left front speakers, a center speaker, and one or two rear speakers).

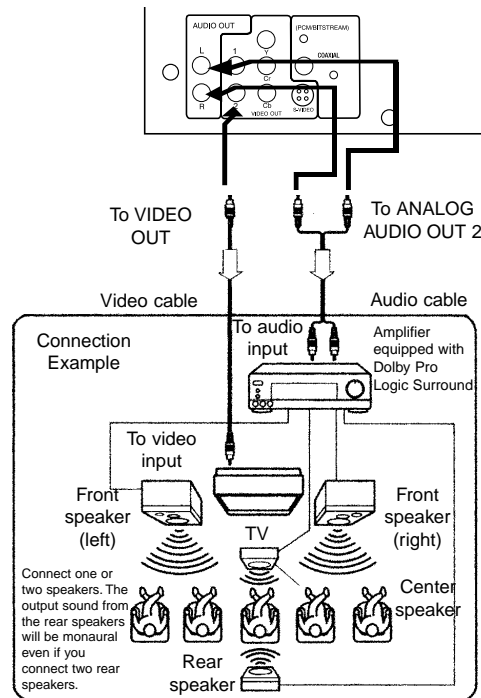

Set "AUDIO OUTPUT" to "ANALOG" via the setup menu.

NOTICE

- It will be helpful to also refer to the manual of the connected TV.
- Turn off the power and unplug both units before setting up any connections.
- Due to the wide dynamic range of sound output of the DVD video player, adjust the volume of your receiver to a comfortably modest listening level to avoid any speaker damage.
- When connecting or disconnecting the DVD video player, be sure to turn off the amplifier to avoid any speaker damage.

Connecting to Optional Equipment

Enjoy Dolby Digital or DTS (BEST)

Dolby Digital/DTS

Dolby Digital and DTS surround sound are currently what you hear when you go to movies. Now you can enjoy home theater, or concert like audio with the most amazing sound quality, in the comforts of your own home.

Dolby Digital and DTS programming can deliver surround with five discrete full range channels plus a sixth channel for subwoofers. You can enjoy your APEX DVD with your Dolby Digital or DTS Digital Surround Sound System. All you need is to connect your DVD player to a Dolby Digital/DTS receiver, or a Dolby Digital Ready receiver with an external (AC-3) decoder.

How to setup the sound output

- From the SETUP MENU displays, set the "AUDIO OUT PUT" to "SPDIF/RAW".

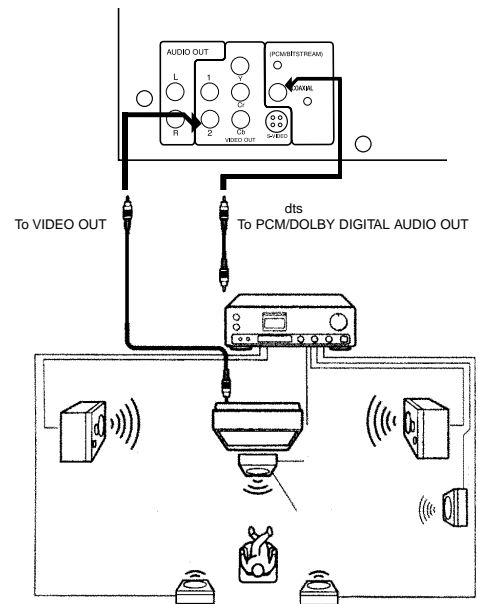

This product incorporates copyright protection technology that is protected by method claims of certain U.S. patents and other intellectual property rights owned by Macrovision Corporation and other rights owners. Use of this copyright protection technology must be authorized by Macrovision Corporation, and is intended for home and other limited viewing uses only unless otherwise authorized by Macrovision Corporation. Reverse engineering or disassembly is prohibited.

It is forbidden by law to copy, broadcast, show, broadcast on cable, play in public, and rent copyrighted material without permission. DVD video discs are copy protected, and any recordings made from these discs will be distorted.

Manufactured under license from Dolby Digital Laboratories. "Dolby" and the Double-D symbol are trademarks of Dolby Laboratories. Confidential unpublished works. ©1992-1997 Dolby Laboratories, Inc. All rights reserved.

"DTS" and "DTS Digital Out" are trademarks of Digital Theater System, Inc.

NOTICE

- Do not connect the PCM/DOLBY DIGITAL AUDIO OUT jack of the DVD video player to the AC-3 RF input of a Dolby Digital receiver. Instead, connect to the "DIGITAL" or "COAXIAL" input of a Dolby Digital/DTS receiver or Processor. The input of the A/V receiver is not compatible with the PCM/DOLBY DIGITAL AUDIO OUT jack and is primarily for Laserdiscs only.
- Connect the PCM/DOLBY DIGITAL AUDIO OUT jack of the DVD video player to the "DIGITAL" or "COAXIAL" input of a Dolby Digital/DTS receiver or Processor.
- It will be helpful to also refer to the manual of the connected TV.
- Turn off the power and unplug both units before setting up any connections.
- Due to the wide dynamic range of sound output of the DVD video player, adjust the volume of your receiver to a comfortably modest listening level to avoid any speaker damage.
- When connecting or disconnecting the DVD video player, be sure to turn off the amplifier to avoid any speaker damage.

Connecting to an Audio System or TV Component Video Input

BEST PICTURE

The Component Video input allows you to enjoy the sound and picture quality of the DVD video discs.

• How to setup the sound output

From the SETUP MENU, set the "AUDIO OUTPUT" To "ANALOG".

• How to setup the video output

From the SETUP MENU, set the "SET VIDEO OUT" to "YUV VIDEO" when using the Component Video output jacks.

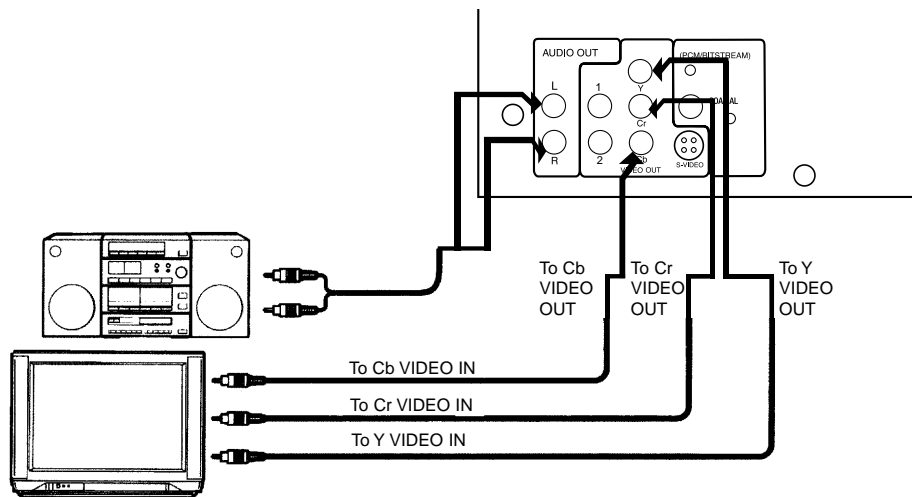

NOTICE

- It will be helpful to also refer to the manual of the connected TV.
- Turn off the power and unplug both units before setting up any connections.
- Keep the DVD video player away from any tuner or radio to avoid any static or distorted sound during a broadcast.
- When connecting any disconnecting the DVD video player, be sure to turn off the amplifier to avoid any speaker damage.
- Due to the wide dynamic range of sound output of the DVD video player, adjust the volume of your receiver to a comfortably modest listening level to avoid any speaker damage.

NOTICE (COMPONENT VIDEO OUTPUT)

Component input terminals when connected to selected TVs and monitors will produce a higher quality picture playback. Depending on the selected TVs and monitors, the wording of the component input terminals may vary. (ie:R-Y, Y, B-Y, etc.) If there are any fluctuations with the color played back adjust the TV or monitor to achieve the best audio and/or picture.

Connection 3

Connecting the TV , DVD, VCR, and Cable or Satellite Box

Figure 3

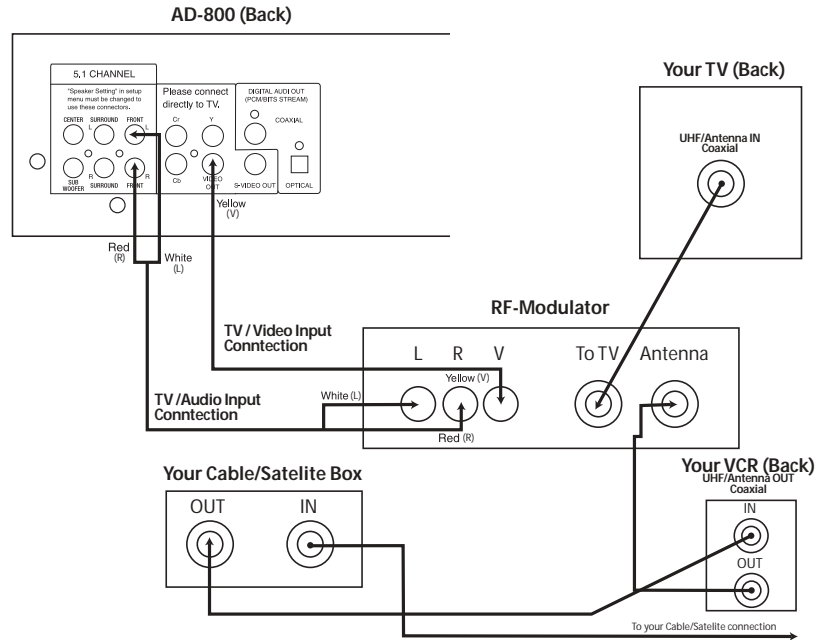

Connecting to a TV using a RF Modulator

Connection 1

Connecting the TV to the DVD through the VCR

Figure 1

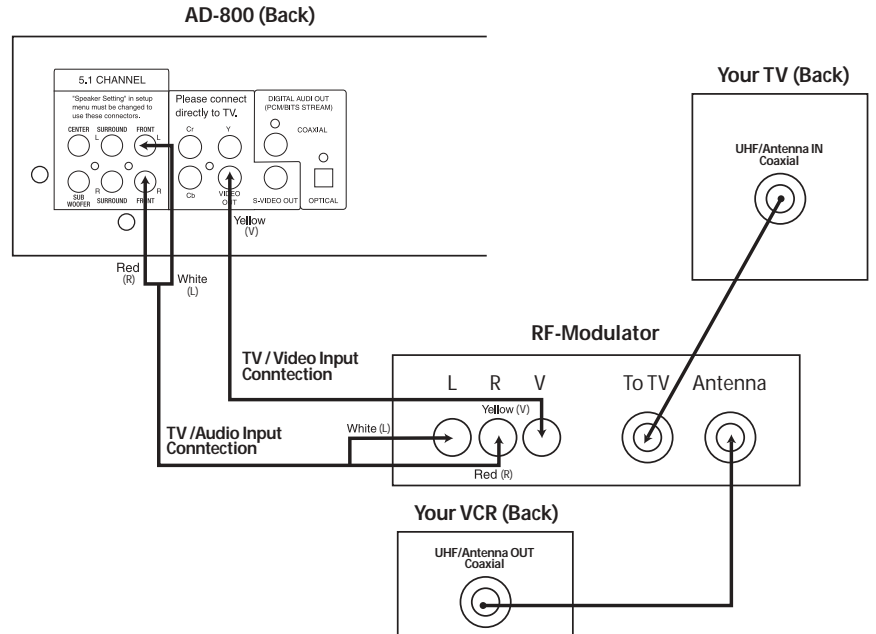

Connection 2

Connecting the TV to the DVD through the Cable or Satellite Box

Figure 2

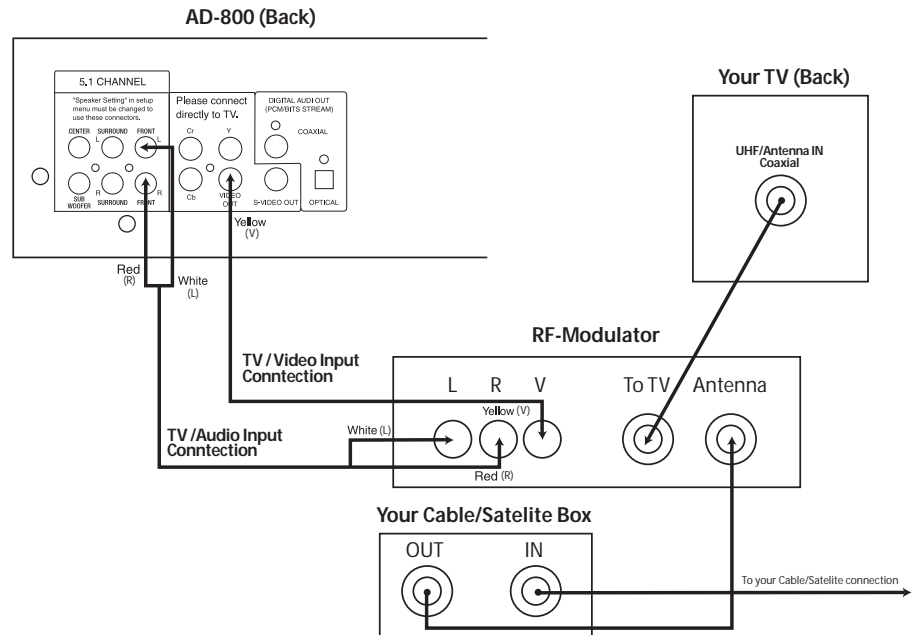

Connecting to a TV

GOOD, BETTER, BEST

Connecting the DVD video player to your TV.

- **How to setup the sound output**

From the SETUP MENU, set the "AUDIO OUTPUT" to "ANALOG".

- **How to setup the video output**

From the SETUP MENU, set the "SET VIDEO OUT" to "S-VIDEO" when using the S VIDEO OUT jack.

GOOD

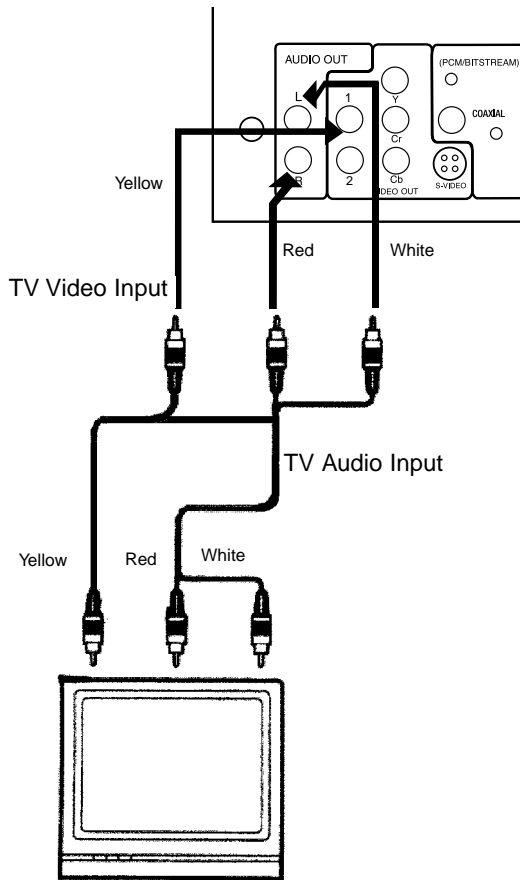

BETTER

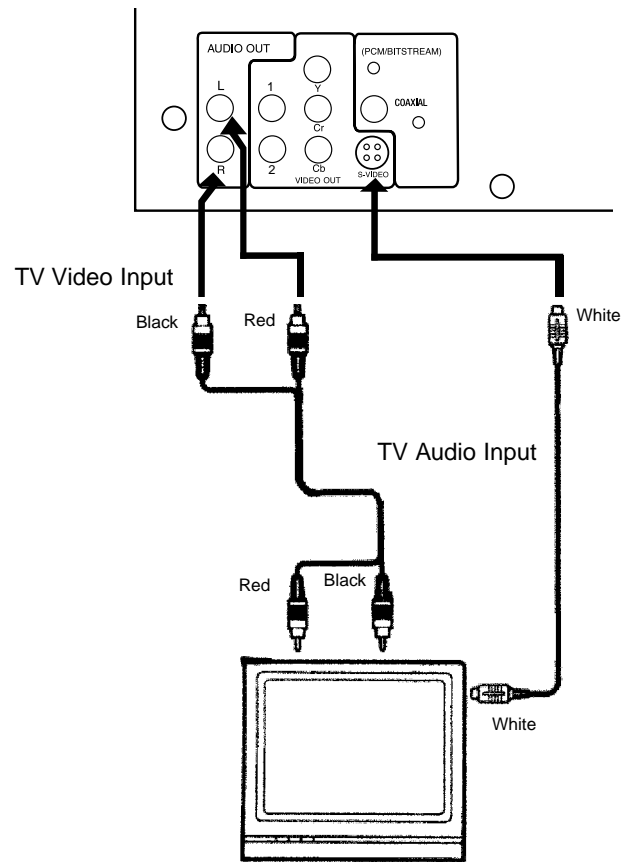

Connect the DVD video player with the S Video cable, if the TV has an S video input. Do not connect the yellow video cable if using the S Video cable.

NOTICE

- It will be helpful to also refer to the manual of the connected TV.
- Turn off the power and unplug both units before setting up any connections.
- The playback picture will be distorted, if you do not connect the DVD video player directly to your TV because DVD video discs are protected by Macrovision.
- Therefore, if you connect the DVD video player to a video cassette recorder (VCR), or TV/VCR combination, the playback picture will be distorted.

Connection 2

Connecting the TV to the DVD through the Cable or Satellite Box

1) Connect the three-terminal composite video cable to the back of your Apex DVD player. This cable has three prongs, one each in yellow, red, and white. The yellow prong will go into the jack labeled "Video Out"; the white prong will go into the jack labeled "Front-L"; the red prong will go into the jack labeled "Front-R".

2) Connect the opposite end of the composite-video cable into the back of the RF modulator. Make sure to match up the colors correctly.

3) Connect a coaxial cable from the "Antenna Out" jack on the back of your Cable or Satellite receiver to the "Antenna" jack on the RF modulator. The coaxial cable is the one-wire, metal-ended type that you screw onto the VCR.

Figure 2

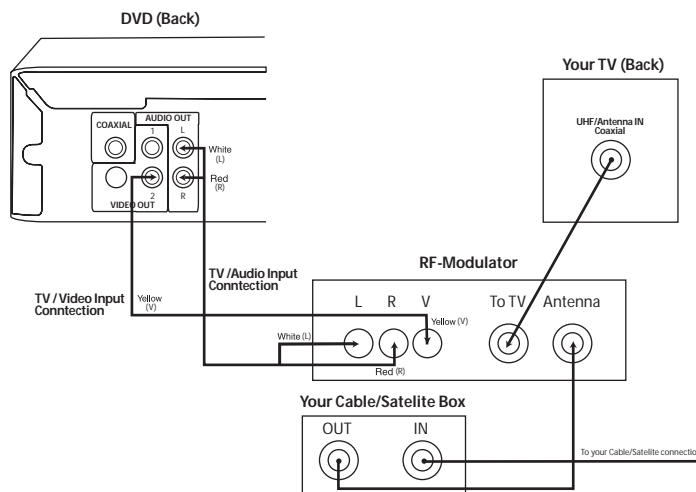

4) Connect a coaxial cable from the "To TV" jack on the RF modulator to the jack on the back of your TV.

5) Make sure your TV is set to the appropriate channel before using your DVD player. In most cases, this is channel 3 or 4.

Connection 3

Connecting the TV , DVD, VCR, and Cable or Satellite Box

1) Connect the three-terminal composite video cable to the back of your Apex DVD player. This cable has three prongs, one each in yellow, red, and white. The yellow prong will go into the jack labeled "Video Out"; the white prong will go into the jack labeled "Front-L"; the red prong will go into the jack labeled "Front-R".

2) Connect the opposite end of the composite-video cable into the back of the RF modulator. Make sure to match up the colors correctly.

3) Connect a coaxial cable from the "Antenna Out" jack on the back of your cable or satellite receiver to the "Antenna In" jack on the back of your VCR. The coaxial cable is the one-wire, metal-ended type that you screw onto the VCR.

4) Connect a coaxial cable from the "Antenna Out" jack on the back of your VCR to the "Antenna" jack on the RF modulator.

5) Connect a coaxial cable from the "To TV" jack

Figure 3

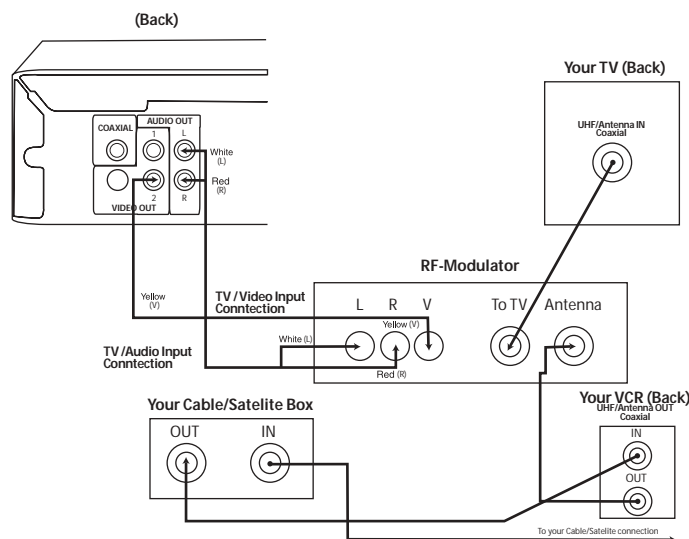

on the RF modulator to the jack on the back of your TV.

6) Make sure your TV is set to the appropriate channel before using your DVD player. In most cases, this is channel 3 or 4. Also make sure

that the VCR is set to the appropriate channel, as well. This selector is usually on the back of your VCR. Consult your VCR manual for further information.

Connecting to a TV using a RF Modulator

Note: Not all RF Modulators are compatible with APEX Digital players. Please see our website for recommendations.

Many older televisions do not have the newer component-video, composite-video, or s-video connections that optimize DVD technology. While it would be advised to purchase a newer television in order to take full advantage of the digital quality of DVD's, it is possible to connect an older television to a DVD player. This connection requires a device called an RF modulator.

First, it is necessary to ascertain whether or not your TV needs a RF modulator. Look at the back of your TV. If you see three input connectors lined up in a row, in the colors of yellow, red, and white, then you will not need an RF modulator. If you see a connector labeled "s-video", then you will not need an RF modulator. If you do not have either of these connectors, then you will need to purchase an RF modulator from the store where you purchased your Apex Digital DVD player or other home electronics retailers.

Older televisions use a coaxial connection, which combines all of the video signal from an exterior source into a single line. This line is then translated by your TV into the picture you see. The RF modulator combines the output signals from the DVD player, or any other device, into the coaxial connection for use by your television.

Below are written and pictorial instructions on the proper way to connect an RF modulator to your Apex DVD player and your TV.

Connection 1

Connecting the TV to the DVD through the VCR

Note: Many VCRs will distort the picture of a DVD player. This is NOT a malfunction of the DVD player or VCR. All DVD manufacturers are required to install macrovision copyright circuitry to prevent copying via VCR. This is what causes the distortion.

1) Connect the three-terminal composite video cable to the back of your Apex DVD player. This cable has three prongs, one each in yellow, red, and white. The yellow prong will go into the jack labeled "Video Out"; the white prong will go into the jack labeled "Front-L"; the red prong will go into the jack labeled "Front-R".

2) Connect the opposite end of the composite-video cable into the back of the RF modulator. Make sure to match up the colors correctly.

3) Connect a coaxial cable from the "Antenna Out" jack on the back of your VCR to the "Antenna" jack on the RF modulator. The coaxial cable is the one-wire, metal-ended type that you screw onto the VCR.

4) Connect a coaxial cable from the "To TV" jack on the RF modulator to the jack on the back of your TV.

Figure 1

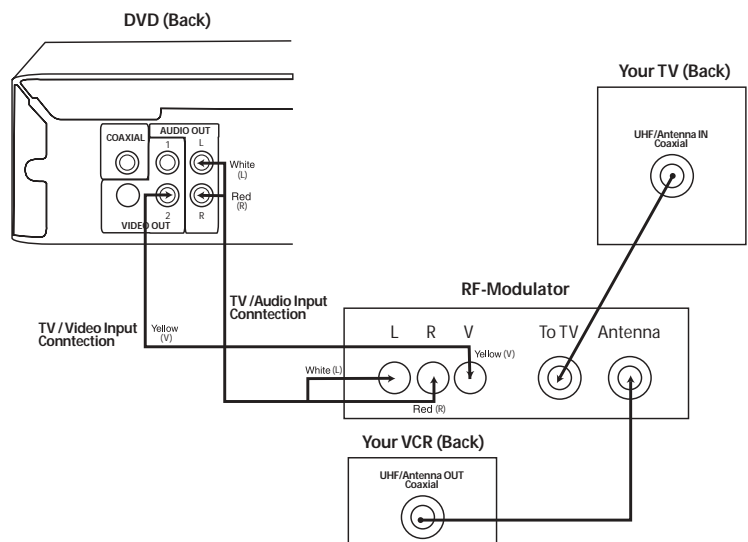

5) Make sure your TV is set to the appropriate channel before using your DVD player. In most cases, this is channel 3 or 4.

PREPARING THE REMOTE CONTROL

To operate the DVD video player, you must first place the batteries in the remote control.

1

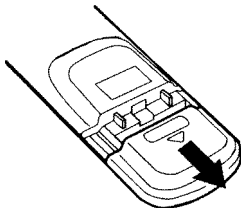

Open the cover.

2

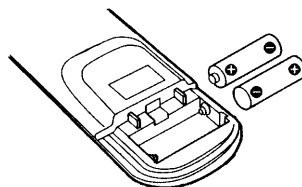

Insert batteries (AAA size).

Make sure to match the + and - on the batteries to the marks inside the battery compartment.

3

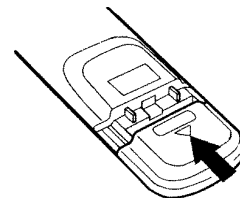

Close the cover.

OPERATING WITH THE REMOTE CONTROL

Operating DVD video player with the remote control.

1

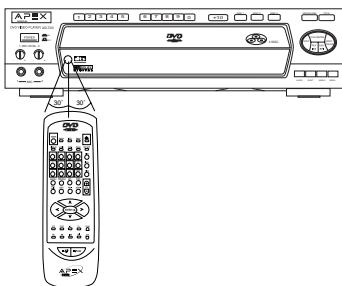

The remote control must point at the remote sensor, in order for the DVD player to function correctly.

Distance: Maximum of 7 m from the front of the remote sensor.

Angle: Approximately 30° from each direction.

**Please do not place the remote sensor towards any light source such as direct sunlight or illumination. The DVD video player will malfunction, if you do so.*

NOTICE (BATTERIES)

FOLLOW INSTRUCTIONS BELOW BECAUSE INCORRECT USE OF BATTERIES MIGHT CAUSE THEM TO LEAK OR CORRODE.

- Do not place the batteries in the wrong direction.
- It is dangerous to charge/heat/open or short-circuit the batteries.
- Do not leave dead batteries or mix old/new batteries in the remote control.
- When not using the remote control for a long duration of time, remove the batteries.
- When difficulties occur, with the remote control, or if the operating range becomes reduced, then replace the batteries.
- If leakage from the battery occurs, wipe the battery liquid from the battery compartment, then replace the batteries.
- With normal usage the batteries should last one year.

NOTICE (REMOTE CONTROL)

- The remote control should be aimed directly towards the remote sensor of the DVD video player.
- Avoid dropping the remote control.
- Avoid spilling any liquids and/or extreme heat.

Remote Control

THE INSTRUCTIONS IN THIS MANUAL DESCRIBE THE FUNCTIONS ON THE REMOTE CONTROL.

- | | |
|-------------------|------------------|
| 1. TITLE | 20. PBC OFF |
| 2. POWER | 21. SUB-T |
| 3. SETUP | 22. DISC1 |
| 4. DISPLAY | 23. DISC2 |
| 5. AUDIO | 24. DISC3 |
| 6. NUMBERS | 25. MUTE |
| 7. SHUFFLE | 26. KEY + |
| 8. PROGRAM | 27. VOLUME |
| 9. VOCAL ASSIST | 28. ECHO + |
| 10. GOTO | 29. ECHO - |
| 11. SLOW | 30. KEY - |
| 12. REPEAT | 31. ENTER/PLAY |
| 13. REVERSE | 32. A-B |
| 14. FORWARD | 33. RESUME |
| 15. PREVIOUS SKIP | 34. P/N |
| 16. STOP | 35. ZOOM |
| 17. MENU | 36. FORWARD SKIP |
| 18. OPEN/CLOSE | 37. PAUSE/STEP |
| 19. ANGLE | |

Press **1**, **2** or **3** anytime on the front panel or on the remote control unit, you can switch the disc inside the 3 disc changer.

Press OPEN/CLOSE on the front panel, you can change the rest of two discs and it will not affect the disc that is currently playback. After you finish changing the two discs, press OPEN/CLOSE again and the loader will close and store that two discs inside the 3-disc changer.

NOTICE

- Press OPEN/CLOSE in order to close the disc tray during playback. It will not close the disc tray automatically during playback.
- A few seconds are needed during switching inside the 3-disc changer.

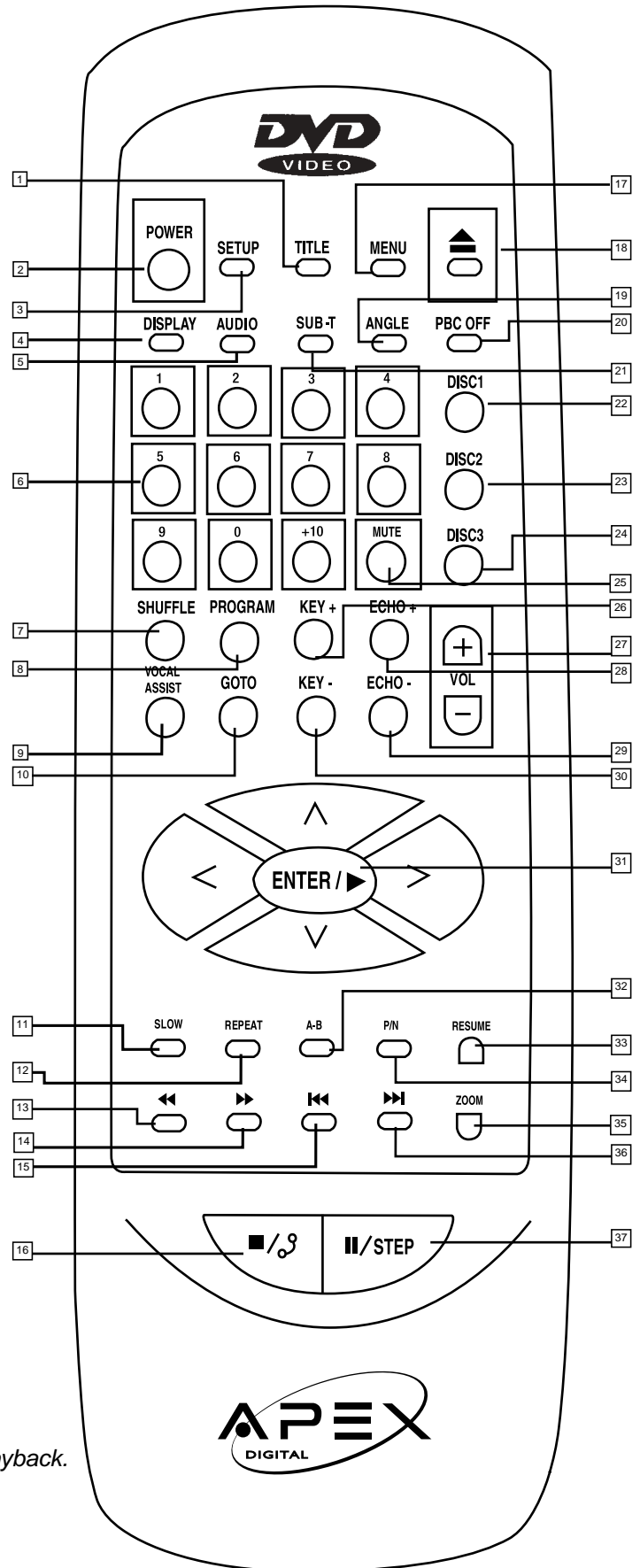

Remove a Disc

REMOVE A DISC

How to remove a disc that is currently playback.

1. Press **STOP**.
2. Press the **DISC** button that is not currently playback.

For example:

To remove DISC 1, you need to press either DISC 2 or DISC 3.

3. Press **OPEN/CLOSE**.
4. Remove the disc.

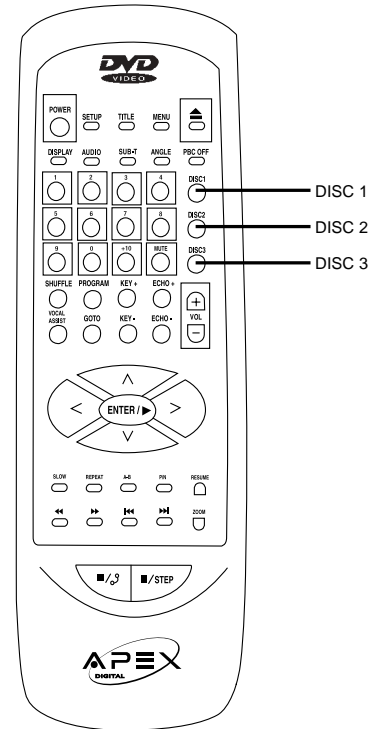

WHAT IS VCD?

A VCD looks like an ordinary 5" CD with the same digital audio quality, plus good video capability. It is a new video format that offers a quality picture with over an hour of playing time.

Note:

- 1) When you playback video CD, you must turn **PBC OFF** in order to stop the chapter/scene.
- 2) The AD-703A DVD player will only play "Comercially" made VCD and SVCD's. Apex does not now of any software that will produce VCD's or SVCD on a PC or MAC.

DVD Display

■ The indicators vary depending on the kinds of discs you play.

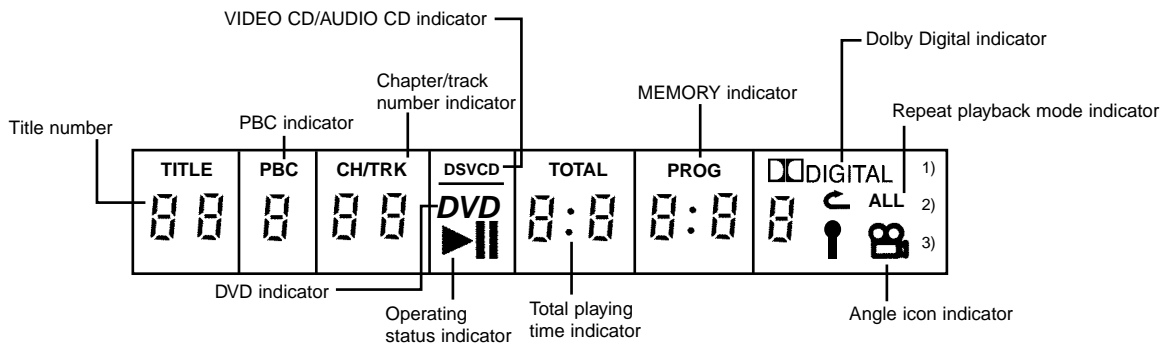

DVD Video discs

- When closing the disc tray:
Example:
- During playback:
Example:

Some DVD video discs may not display the chapter numbers or elapsed time.

VCD Video discs

- When closing the disc tray:
Example:
- During playback:
Example:

Compact Disc

- When closing the disc tray:
Example:
- During playback:
Example:

• Other indicators

- When playing back the same title, chapter or track repeatedly.
- When playback is paused.
- When playing back a specific segment repeatedly. (A-B repeat)

RANDOM During memory playback.

MEMORY During shuffle playback.

When playing back the entire disc repeatedly.

ALL

When the camera angle can be changed.

• Display directions

OPEN	_____	OPEN	CLOSE	_____	CLOSE
INIT	_____	INITIAL	STOP	_____	STOP
TITLE	_____	TITLE	ROOT	_____	ROOT

Identification of Controls

FRONT PANEL

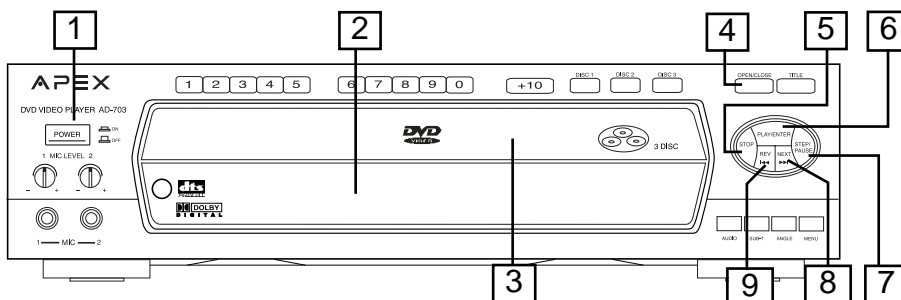

- | | | | |
|---|-------------------|---|------------|
| 1 | POWER ON/OFF | 6 | PLAY/ENTER |
| 2 | DVD DISPLAY | 7 | STEP/PAUSE |
| 3 | DISC LOADING TRAY | 8 | NEXT |
| 4 | OPEN/CLOSE | 9 | PREVIOUS |
| 5 | STOP | | |

REAR PANEL

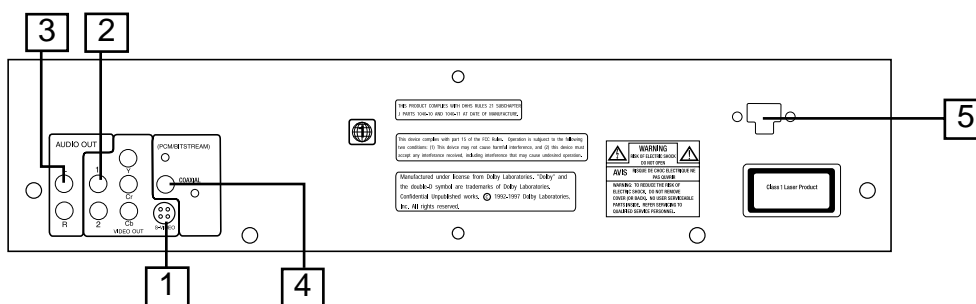

- | | |
|---|------------------------------|
| 1 | S-VIDEO OUTPUT |
| 2 | COMPOSITE VIDEO OUTPUT |
| 3 | ANALOG AUDIO OUTPUT |
| 4 | DIGITAL AUDIO-COAXIAL OUTPUT |
| 5 | POWER CORD INPUT |

Table of Contents

Safety Precautions	1	Playing in Random Order	22
Important Safety Instructions	2 - 3	Zooming a Picture	23
Introduction	4	Selecting the Camera Angle/ Selecting a Language	24
Identification of Controls	6	Playing in a Favorite Order.....	25
DVD Display	7	Selecting Subtitles	26
Removing Disc & What is VCD?	8	Karaoke	27 - 28
Remote Control	9 - 10	Using the On-screen Display	29
Connecting to a TV	11	Setting the Parental Lock	30
Connecting to a TV using a RF Modulator	12	Customizing the Function Settings	31
Connecting to an Audio System or TV Component Video Input	12	Notes on Discs	32
Connecting to Optional Equipment....	13 - 14	Specifications	33
Playing Back a Disc	15 - 18	Before Calling Service Personnel	34
Locating a Specific Title, Chapter or Track	19 - 20	Memo	35
Playing Repeatedly	21	Limited Warranty.....	36

Introduction

Your DVD video player is a player for digital video discs conforming to the universal DVD video standard. With it, you will be able to enjoy full-length movies with true cinema picture quality, and stereo or multichannel sound (depending on the disc, and on your playback setup). The unique features of this DVD video, such as selection of sound track and subtitle languages, and of different camera angles (again depending on the disc), are all included. What's more, Parental Control lets you decide which discs your children will be able to see.



You will find your player remarkably easy to use, by way of the On-Screen Display (setup menu) and player display, in combination with the remote control.

UNPACKING

When shipping the DVD video player, the original shipping carton and packing comes in handy. For maximum protection, repack the unit as it was originally packed at the factory.

First check and identify the contents of your DVD video player package, as listed below:

- DVD video player
- Remote control handset with separately packed batteries
- Power cable
- S-Video cable (1)
- RCA cables (3) (1 yellow, 1 red, and 1 white)
- Owner's manual
- Size AAA batteries (2)

If any item should be damaged or missing, please inform your supplier without delay.

Keep the packaging materials, you may need them to transport your player in the future.

WHERE TO LOCATE YOUR DVD

- Place the unit on a firm, flat surface.
- When you place this DVD video player near a radio, or VCR, the playback picture may become poor and/or distorted. In this situation, move the DVD video player away from the other units.
- Keep away from direct sunlight & domestic heating equipment.
- If placed in a cabinet, please allow at least 2.5 cm (1 inch) of free space all around the player for proper ventilation.

TO OBTAIN A CLEAR PICTURE

The DVD video player is a high technology, precision device. If the optical pick-up lens and disc drive parts are dirty or worn down, the picture quality becomes poor. To obtain a clear picture, we recommend regular inspection and maintenance (cleaning or parts replacement) every 1,000 hours of use depending on the operating environment. For details, contact your nearest dealer.

Important Safety Instructions

14. OBJECT AND LIQUID ENTRY - Care should be taken so that objects do not fall and liquids are not spilled into the units openings. Such situations could result in fire or electrical shock.

15. NON-USE PERIODS - The power cord of the unit should be unplugged, when not in use for a long time.

16. Disc - Do not use a deformed, cracked, or heavily scratched disc. Using these disc will limit your viewing pleasure, and/or may damage the internal workings of your machine.

17. LIGHTING AND POWER SURGES - Use a power strip to help eliminate surges and spikes caused by lighting and static electric charges.

18. POLARIZATION OR GROUNDING - Precautions should be taken so that the polarization or grounding means of a unit is not defeated. To prevent electric shock match the wide blade of the plug to the wide slot of the outlet and fully insert. If the wide blade does not match up with the outlet try reversing the plug.

19. SERVICING - Do not attempt to service this unit yourself. Only qualified APEX service technicians should work on your DVD Player.

20. DAMAGE REQUIRING SERVICE - The unit should be serviced by qualified APEX authorized specialist when:

- A. The unit does not appear to operate normally or exhibits a marked change in performance.*
- B. When the power supply cord or plug is damaged.*
- C. If objects have fallen, or liquid has been spilled into the unit.*
- D. If the unit has been exposed to water or rain.*
- E. If the unit has been dropped or damaged in any way.*

21. SAFETY CHECK - Ask the service technician to perform safety checks upon completion of the unit.

22. WALL AND CEILING MOUNTING - The unit should be mounted to a wall or ceiling only as recommended by the manufacturer.

Important Safety Instructions

CAUTION:

PLEASE READ AND OBSERVE ALL WARNINGS AND INSTRUCTIONS GIVEN IN THIS OWNER'S MANUAL AND THOSE MARKED ON THE UNIT. PLEASE KEEP THIS MANUAL FOR FUTURE USE.

This product was designed and manufactured to meet strict quality and safety standards. The safeguards incorporated in this unit will protect you if you observe the following procedures for installation, use, and service. There are, however, some installation and operation precautions which you should be aware of.

1. READ THE OWNER'S MANUAL - Follow all the operating and installation instructions.

2. RETAIN INSTRUCTIONS - The safety and operating instructions should be retained for future use.

3. PAY ATTENTION TO WARNINGS - All warnings on the appliances and in the operating instructions should be followed.

4. FOLLOW INSTRUCTIONS - Follow all operating instructions to achieve optimal use.

5. POWER SOURCES - This product should only be operated from the type of power source indicated on the label.

6. HEAT - This unit should be situated away from heat sources, such as amplifiers, radiators, stoves or any other units producing heat.

7. WATER AND MOISTURE - Do not use this unit near water, for example: near the kitchen sink, a bath tub, washbowl, laundry tub, swimming pool, or in a wet basement.

8. CLEANING - Unplug the unit from the wall outlet before cleaning. Do not use liquid cleaners or aerosol cleaners directly on the unit. Use a damp cloth for cleaning.

9. CARTS AND STANDS - The unit and cart combination should be moved with care. Quick stops, excessive force and uneven surfaces may cause the unit and cart combination to overturn. The unit should be used only with a cart or stand recommended by the manufacturer.

10. POWER-CORD PROTECTION - Power-supply cords should be routed so that they are not likely to be walked on or pinched by items placed upon or against them.

11. OVERLOADING - Do not overload wall outlet, or extension cords. This can result in a risk of fire or electrical shock.

12. DISC TRAY - Keep your fingers well clear of the disc tray as it is closing. It may cause serious personal injury, or do damage to the machine.

13. WEIGHT - Do not place a heavy object (amplifier, receiver) on your DVD player. The object may fall, causing serious personal injury or death.

Safety Precautions



The lightning flash with a arrowhead symbol within an equilateral triangle is intended to alert the user to the presence of uninsulated "dangerous voltage" within the product's enclosure that may be of sufficient magnitude to constitute a risk of electric shock to persons.



The exclamation point within an equilateral triangle is intended to alert the user to the presence of important operating and maintenance (servicing) instructions in the literature accompanying the appliance.

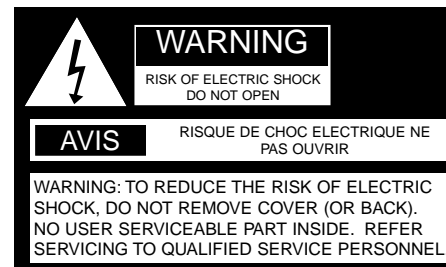

WARNING: DO NOT EXPOSE THIS APPLIANCE TO RAIN OR MOISTURE, DUE TO THE HIGH RISK OF FIRE OR ELECTRIC SHOCK, DO NOT OPEN THE CABINET DANGEROUS HIGH VOLTAGES ARE PRESENT INSIDE THE ENCLOSURE. ONLY QUALIFIED SERVICE PERSONNEL SHOULD ATTEMPT THIS.

CAUTION: TO PREVENT ELECTRIC SHOCK, MATCH WIDE BLADE OF PLUG TO WIDE SLOT, AND FULLY INSERT.

ATTENTION: POUR EVITER LES CHOCS ELECTRIQUE, INTRODUIRE LA LAME LA PLUS LARGE DE LA FICHE DANS LA BORNE CORRESPONDANTE DE LA PRISE ET POUSSER JUSQU' AU FOND.

CAUTION: This Digital Video Disc Player employs a Laser System. To prevent direct exposure to the laser beam, do not try to open the enclosure. Visible laser radiation when open and interlocks defeated.

The use of control adjustments or the performance of procedures other than those specified may result in hazardous radiation exposure.
DO NOT STARE INTO BEAM.

To ensure proper use of this product, please read this owner's manual carefully and retain for future reference. Should the unit require maintenance, contact an authorized service location, or contact APEX Digital Inc. Only qualified service personnel should remove the cover.

FCC NOTICE: This equipment has been tested and found to comply with the limits for a Class B digital device. Pursuant with the FCC Rules, Part 15. These limits are designed to provide reasonable protection against harmful interference in a residential installation.

WARNING: Changes or modifications made to this equipment, not expressly approved by APEX or parties authorized by APEX will void all the manufacture warranties.

THE REGION CODE FOR THE UNIT IS 1.



Since it is very usual for DVD movies to be released at different times in different regions of the world, all players have region codes and disks can have an optional region code. If you load a disk of a different region code to your player, you will see the region code notice on the screen. The disk will not play, and should be unloaded.

For Customer Use:

In spaces provided below, record the Model and Serial No. located on the rear panel of your DVD video player.

Model No. _____ **Serial No.** _____

Retain this information for future reference.

Free Manuals Download Website

<http://myh66.com>

<http://usermanuals.us>

<http://www.somanuals.com>

<http://www.4manuals.cc>

<http://www.manual-lib.com>

<http://www.404manual.com>

<http://www.luxmanual.com>

<http://aubethermostatmanual.com>

Golf course search by state

<http://golfingnear.com>

Email search by domain

<http://emailbydomain.com>

Auto manuals search

<http://auto.somanuals.com>

TV manuals search

<http://tv.somanuals.com>