

AT STEREO COLOR TELEVISIONS

INSTRUCTION MANUAL

Stereo Series - AT2002S, AT2402S, AT2702S



Please read this manual carefully before operation.

APEX Digital, Inc.
2919 E. Philadelphia Avenue
Ontario, California 91761
909-930-1239

FOR SERVICE CALL: 800-4-APEX-INC

TABLE OF CONTENTS

INTRODUCTION	
Safety Precautions	2
Specifications	5
Feature Content	6
Front and Rear Unit Profiles	
AT2002S	8
AT2402S	9
AT2702S	10
Remote Control Features	11
INSTALLATION	
Connecting the Antenna	12
Installing the Remote Control Batteries	12
Connecting A/V Equipment	
From Device to TV	13
From TV to Device	13
FUNCTIONS & FEATURES	
Power On/Off	14
On Screen Display	14
Basic Functions	
Changing Channels	14
Adjusting Volume	14
Muting the Volume	14
Menu Selections	
Picture Menu	15
Tuner Menu	15
Timer Menu	16
System Menu	
On Screen Display Language Select	17
Blue Background	17
Closed Captions	17
Parental Guide	18
Other Useful Features	19
TROUBLESHOOTING GUIDE	20
LIMITED UNITED STATES WARRANTY	22

PACKING LIST

Parts	QTY
AT Series Monaural Color TV	1
Infrared Remote Control	1
Operation Manual	1
AAA Alkaline Batteries	2

BEFORE YOU BEGIN...

Congratulations! You have purchased an APEX Digital Television, one of the finest Color Televisions on the market today.

This manual will guide you in the use of the many exciting features found on APEX Digital televisions. These features will enhance your viewing experience, making your television viewing more enjoyable than ever before. However, before you begin to use your new TV set, it is important that you read through this entire manual for complete operating instructions. After you are finished with this manual, please retain it for future reference. Also, please go through your TV package and verify that it has all of its contents. A packing list can be found on the bottom of the table of contents of this manual.



Customer Record

You will find the model number and chassis number of your TV on the back of your TV set. Record these numbers in the spaces provided below. Refer to them whenever you call APEX Digital customer service or your APEX dealer regarding this product.

Model Number: _____ Chassis Number: _____

Safety Precautions**WARNING:**

TO REDUCE THE RISK OF FIRE OR ELECTRIC SHOCK, DO NOT EXPOSE THIS APPLIANCE TO RAIN OR MOISTURE.

	CAUTION RISK OF ELECTRIC SHOCK DO NOT OPEN	
CAUTION : TO REDUCE THE RISK OF ELECTRIC SHOCK, DO NOT REMOVE COVER (OR BACK). NO USER SERVICEABLE PARTS INSIDE. REFER SERVICING TO QUALIFIED SERVICE PERSONNEL.		



The lightning symbol in the triangle tells you that the voltage inside this product may be strong enough to cause an electric shock.

The exclamation point in the triangle tells you that important operating and maintenance instructions follow this symbol. DO NOT TRY TO SERVICE THIS PRODUCT YOURSELF.

**CAUTION:**

TO PREVENT ELECTRIC SHOCK, DO NOT USE THIS POLARIZED PLUG WITH AN EXTENSION CORD RECEPTACLE OR OTHER OUTLET UNLESS THE PRONGS CAN BE FULLY INSERTED INTO THE OUTLET TO PREVENT ANY EXPOSURE OF THE PRONGS ON THE POLARIZED PLUG.

Avoid displaying stationary images on your TVscreen for extended periods of time. Stationary patterns generated by computer displays, video games, stock market reports, etc. can become permanently displayed on the picture tube. This damage is not protected by your warranty as it is the result of misuse. Should you wish to use your Apex Television to display still images, it is always advisable to reduce brightness and contrast settings. Never leave a video game or computer display unattended.

NOTE TO CABLE INSTALLER IN THE USA:

This reminder is provided to call your attention to Article 820 - 40 of the NEC that provides guidelines for proper grounding and, in particular, specifies that the cable ground shall be connected to the grounding system of the building, as close to the point of cable entry as practical.

BEFORE YOU BEGIN... (continued)

Important Safety Instructions

CAUTION

PLEASE READ THESE INSTRUCTIONS, KEEP THESE INSTRUCTIONS AND HEED ALL WARNINGS. FOLLOW ALL INSTRUCTIONS.

Electrical energy can perform many useful functions. This TV set has been engineered and manufactured to assure your personal safety. However improper use can result in potential electrical shock or fire hazards. In order not to defeat the safe guards incorporated in this TV set, observe the following basic rules for antenna/ TV installation, use and servicing. All operating and use instructions should be followed.

Do not remove the cabinet cover. This may expose you to dangerous voltages. Refer all servicing to qualified service personnel.

Precautions

Power Sources - The TV set should be operated only from the type of power source indicated on the TV set or as indicated in the Operation Manual. If you are not sure of the type of power supply in your home, consult your local power company. For TV sets designed to operate from battery power, or other sources, refer to the operating instructions.

Grounding or Polarization - Do not defeat the safety purpose of the polarized or grounding-type plug. A polarized plug has two blades with one wider than the other. A grounding - type plug has two blades and a third grounding prong. The wide blade or the third prong is provided for your safety. If the provided plug does not fit into your outlet, consult an electrician for replacement of the obsolete outlet. This plug will only fit into a grounding-type power outlet. This is a safety feature. If you are unable to insert the plug into the outlet, contact your electrician to have a suitable outlet installed. Do not defeat the safety purpose of the grounding plug.

Power-Cord Protection - Protect the power cord from being walked on or pinched, particularly at plugs, convenience receptacles, and the point where they exit from the TV.

Overloading - Do not overload wall outlets, extension cords or integral convenience receptacles as this can result in fire or electric shock.

Lightning - For added protection for this TV set during a lightning storm, or when it is left unattended and unused for long periods of time, unplug it from the wall outlet and disconnect the antenna or cable system. This will prevent damage to the product due to lightning and power-line surges. If a snapping or popping sound from a TV set is heard continuously or frequently while the TV set is operated, unplug the TV set and consult your dealer or service technician. It is normal for TV sets to make occasional snapping or popping sounds, particularly when being turned on or off.

Heat - Do not install the TV set near any heat sources such as radiators, heat registers, stoves, or other apparatus (including amplifiers) that produce heat.

Accessories - Do not place the TV set on an unstable cart, stand, tripod, bracket, or table. The TV set may fall, causing serious injury to a child or adult, and serious damage to the TV set. Use only with a cart, stand, tripod, bracket, or table recommended by the manufacturer, or accessory recommended by the manufacturer, or sold with the TV set, and should use a mounting accessory recommended by the manufacturer.

Cart Combination - A product and cart combination should be moved with care. Quick stops, excessive force, and uneven surfaces may cause the TV set and cart combination to overturn.

Water and Moisture Warnings - Do not use the TV set near water - for example, near a bath tub, wash bowl, kitchen sink, or laundry tub; in a wet basement; or near a swimming pool; and the like. The TV set should not be exposed to dripping or splashing and no objects filled with liquids, such as vases, should be placed on the TV set.

Object and Liquid Entry - Never push objects of any kind into the TV set through openings as they may touch dangerous voltage points or short-out parts that could result in a fire or electric shock. Never spill liquid of any kind on the TV set.

Cleaning - Unplug the TV set from the wall outlet before cleaning or polishing it. Do not use liquid cleaners or aerosol cleaners. Use a dry cloth for cleaning the exterior of the TV set.

Attachments - Do not use attachments not recommended by the product manufacturer as they may cause hazards or electric shock.

Ventilation - Slots and openings in the cabinet are provided for ventilation and to ensure reliable operation of the TV set and to protect it from overheating, and these openings must not be blocked or covered. The openings should never be blocked by placing the TV set on a bed, sofa, rug, or other similar surface. This TV set should not be placed in a built-in installation such as a bookcase or rack unless proper ventilation is provided or the manufacturer's instructions have been adhered to.

BEFORE YOU BEGIN... (continued)

Precautions (continued)

Damage Requiring Service - Refer **ALL** servicing to qualified service personnel. Please disconnect your TV set from the wall and contact your local APEX service agent immediately if any of the following conditions are met:

- a. If the power cord or plug is damaged or frayed.
- b. If liquid has been spilled or objects have fallen into the TV set.
- c. If the TV set has been exposed to rain or water.
- d. If the TV set has been subject to excessive shock by being dropped, or the cabinet has been damaged.
- e. If the TV set does not operate normally by following the operating instructions. Adjust only those controls that are covered by the operating instructions as an improper adjustment of other controls may result in damage and will often require extensive work by a qualified technician to restore the TV set to its normal operation.
- f. When the TV set exhibits a distinct change in performance-this indicates a need for service.

Servicing - **Do NOT** attempt to service the TV set yourself as opening or removing covers may expose you to dangerous voltage or other hazards. Refer all servicing to qualified service personnel.

Replacement Parts - When replacement parts are required, be sure the service technician has used replacement parts specified by the manufacturer or have the same characteristics as the original parts. Unauthorized substitutions may result in fire, electric shock, or other hazards.

Safety Check - Upon completion of any service or repairs to the TV set, ask the service technician to perform routine safety checks to determine that the TV set is in proper operating condition.

Disposal - When the TV set reaches the end of its useful life, improper disposal could result in a picture tube implosion. Ask a qualified service technician to dispose of the TV set.

Antenna Setup

Outdoor Antenna Grounding - If an outdoor antenna is installed, follow the precautions below.

An outdoor antenna system should not be located in the vicinity of overhead power lines or other electric light or power circuits, or where it can come in contact with such power lines or circuits.

WHEN INSTALLING AN OUTDOOR ANTENNA SYSTEM, EXTREME CARE SHOULD BE TAKEN TO KEEP FROM CONTACTING SUCH POWER LINES OR CIRCUITS AS CONTACT WITH THEM IS ALMOST INVARIABLY FATAL

Be sure the antenna system is grounded so as to provide some protection against voltage surges and built-up static charges. Section 810 of the National Electrical Code in USA and Section 54 of the Canadian Electrical Code(ANSI/NFPA 70) in Canada provides information with respect to proper grounding of the mast and supporting structure, grounding of the lead-in wire to an antenna discharge unit, size of grounding conductors, location of antenna discharge unit, connection to grounding electrodes, and requirements for the grounding electrode.

Example of antenna grounding according to National Electrical Code (NEC)

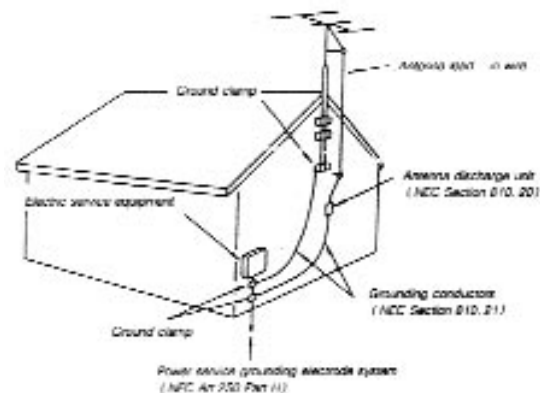

BEFORE YOU BEGIN... (continued)

FCC Warning

Class B Computing Device

Information to User

This equipment has been tested and found to comply with the limits for a Class B Digital Device pursuant to part 15 of FCC Rules. These limits are designed to provide reasonable protection against harmful interference in a residential installation. This equipment generates, uses, and can radiate radio frequency energy and, if not installed and used in accordance with the instructions, may cause harmful interference to radio communications. However, there is no guarantee that interference will not occur in a particular installation. If this equipment receives interference while off and on, the user is encouraged to try to correct the interference by one or more of the following measures:

- 1) Reorient or relocate the receiving antenna.
- 2) Increase the separation between the equipment and TV.
- 3) Connect the equipment into an outlet on a circuit different from that to which the TV is connected.
- 4) Consult the dealer or an experienced radio/TV technician for help and for additional suggestions.

The user may find the following booklet prepared by the Federal Communications Commission helpful: "How to Identify and Resolve Radio - TV Interference Problems". This booklet is available from the US Government Printing Office, Washington, D.C. 20402, Stock No. 004-000-00345-4.

FCC Warning

The user is cautioned that changes or modifications not expressly approved by the manufacturer could void the user's authority to operate the equipment.

NOTE: In order for an installation of the product to maintain compliance with the limits for a Class B Device, shielded cables must be used.

SPECIFICATIONS

MODEL	AT1302	AT2002	AT2402	AT2702
Television System	NTSC-M	NTSC-M	NTSC-M	NTSC-M
Channel Coverage	VHF 2-13, UHF 14~69	VHF 2-13, UHF 14~69	VHF 2-13, UHF 14~69	VHF 2-13, UHF 14~69
Cable TV Coverage	Mid Band (A-8~A-1, A~I); Super Band (J~W) Hyper Band (AA~ZZ, AAA, BBB) Ultra Band (65~94, 100~125)	Mid Band (A-8~A-1, A~I); Super Band (J~W) Hyper Band (AA~ZZ, AAA, BBB) Ultra Band (65~94, 100~125)	Mid Band (A-8~A-1, A~I); Super Band (J~W) Hyper Band (AA~ZZ, AAA, BBB) Ultra Band (65~94, 100~125)	Mid Band (A-8~A-1, A~I); Super Band (J~W) Hyper Band (AA~ZZ, AAA, BBB) Ultra Band (65~94, 100~125)
Channels Preset	181	181	181	181
Antenna Input	75 ohm (unbalanced)	75 ohm (unbalanced)	75 ohm (unbalanced)	75 ohm (unbalanced)
Screen Dimensions	11.02 x 8.27 in 280 x 210 mm	15.98 x 12.01 in 406 x 305 mm	18.82 x 14.29 in 478 x 305 mm	21.3 x 15.9 in 540 x 405 mm
Audio Output	1W x 2	2W x 2	5W x 2	5W x 2
Total Harmonic Distortion	<7%	<7%	<7%	<7%
Power Source	120 VAC, 60 Hz	120 VAC, 60 Hz	120 VAC, 60 Hz	120 VAC, 60 Hz
Unit Weight	25.3 lbs (11.5 kg)	55 lbs (25 kg)	69 lbs. (31.5 kg)	88 lbs. (40 kg)
Unit Dimensions	14.7 x 14.1 x 14.6 in. 373 x 356 x 370 mm	22.3 x 17.8 x 18.8 in 566 x 450 x 477 mm	26.0 x 20.6 x 18.1 in 660 x 522 x 458 mm	29.6 x 23.2 x 18.7 in. 750 x 589 x 474 mm
Packaged Dimensions	17.8 x 16.8 x 16.8 in 450 x 425 x 425 mm	25.2 x 20.9 x 21.3 in 640 x 531 x 540 mm	29.2 x 24.1 x 21.2 in 740 x 610 x 545 mm	33.6 x 27.3 x 22.9 in. 852 x 692 x 580 mm
Power Consumption	70W	90W	125W	135W

BEFORE YOU BEGIN... (continued)**Feature Descriptions**

181 Channel Tuner - total number of channels the TV can receive: 2-69 in Air mode, or 1-125 in Cable mode

AV Input (Rear) - standard composite input designed for use with A/V devices, such as a VCR or DVD player

AV Input (Front) - composite input designed for sporadic use, such as with a camcorder or video game unit

AV Input (Side) - composite input designed for sporadic use, such as with a camcorder or video game unit

AV Output (Rear) - composite output for signals from TV to devices such as VCRs

AV Stereo Sound - stereo sound for superior TV viewing experience

Channel Recall - instant return to the last channel viewed

Closed Caption Display - feature that displays the text of a TV broadcast

Full Feature Remote Control - the remote control can execute all functions of the TV

On/Off Timer - feature that allows the user to set a time for the TV to turn on or off

Parental Control - used to lock out unacceptable programming

RF Antenna Jack - standard coaxial antenna jack

S-Video Input - input designed for greater clarity and sharpness; also known as S-VHS

Screen Size - the diagonal size of the TV screen

Selectable Picture Modes - preset standards for TV display: Normal, Theater, and Memory

Trilingual On Screen Display (OSD) - TV's on screen display can be either English, French, or Spanish

Feature	AT2002S	AT2402S	AT2702S
181 Channel Tuner	1	1	1
AV Input (Rear)	1	3	3
AV Input (Front)	-	-	1
AV Input (Side)	1	-	-
AV Output (Rear)	1	1	1
AV Stereo Sound	1	1	1
Channel Recall	1	1	1
Closed Caption	1	1	1
Full Feature Remote	1	1	1
On/Off Timer	1	1	1
Parental Control	1	1	1
RF Antenna Input	1	1	1
S-Video Input	1	1	1
Screen Size	20"	24"	27"
Picture Modes	1	1	1
Trilingual OSD	1	1	1

Front and Rear Unit Profiles

AT2002S

Front panel

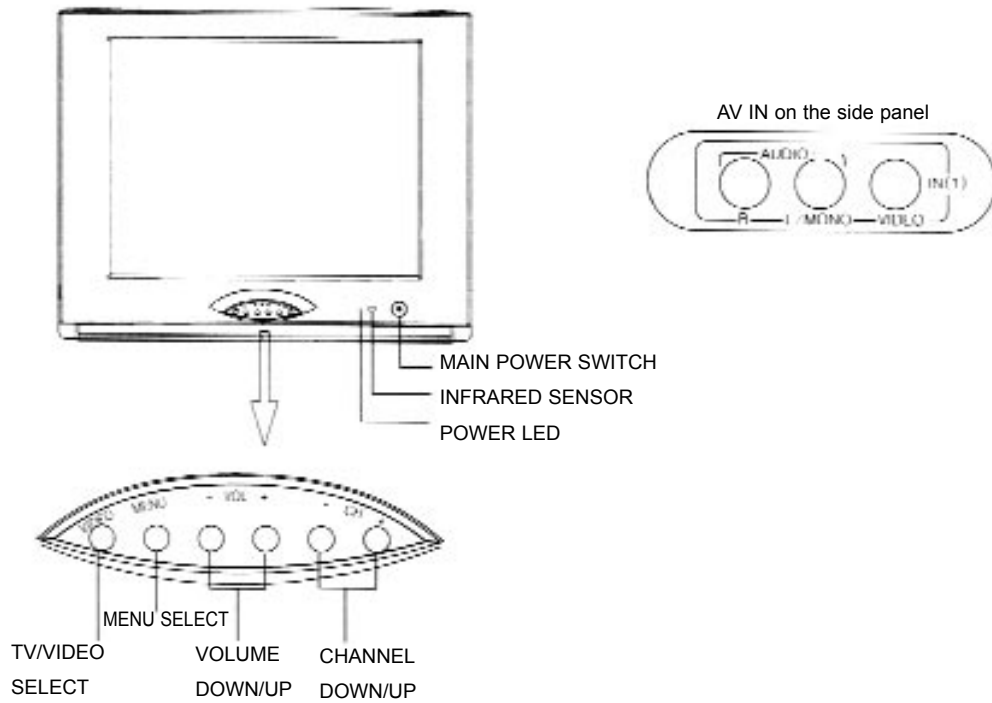

Rear panel

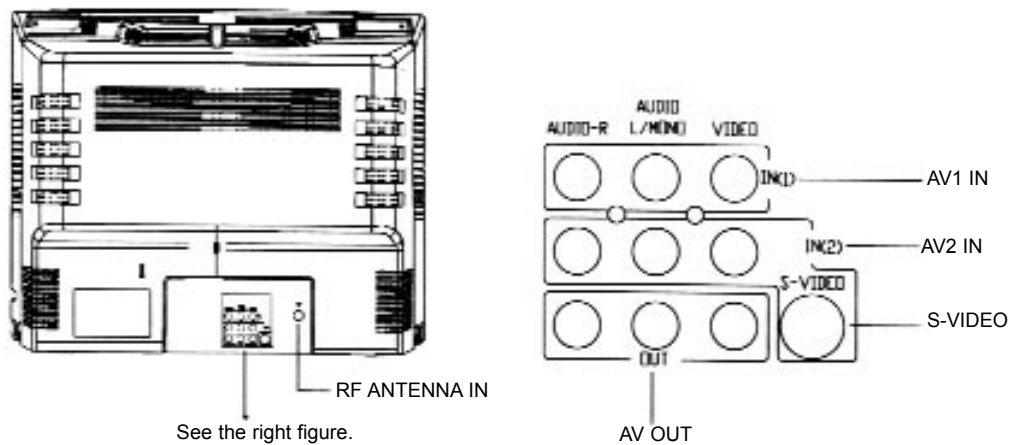

Front and Rear Unit Profiles (continued)

AT2402S

Front panel

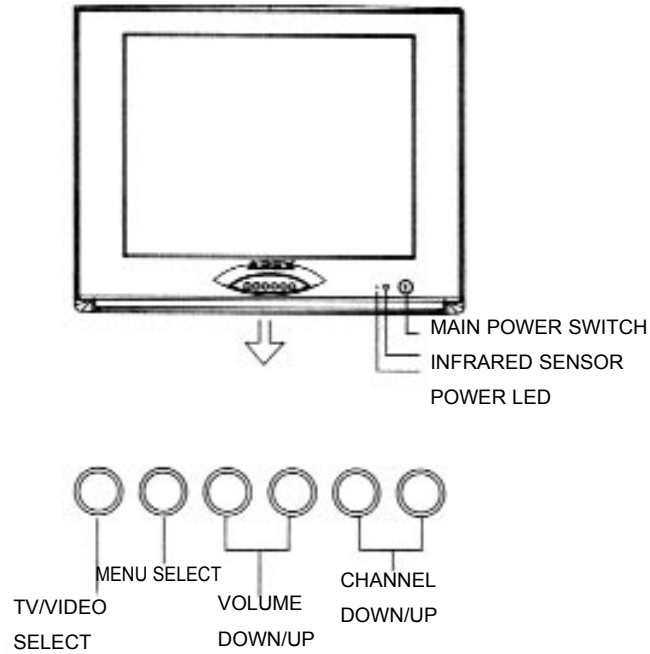

Rear panel

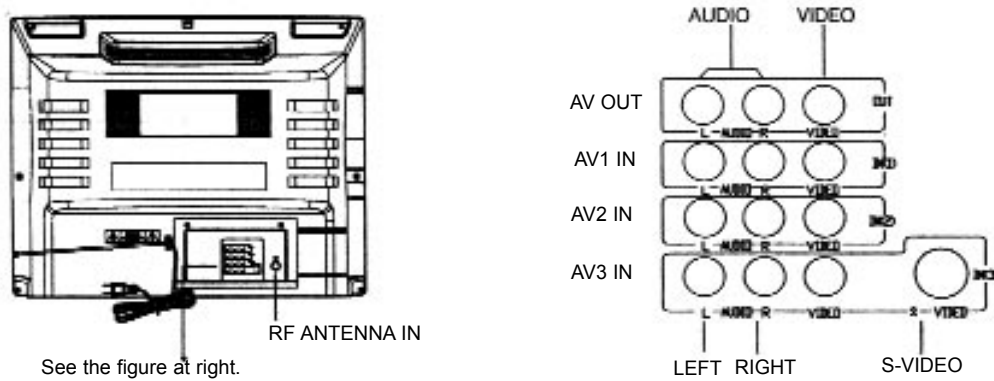

Front and Rear Unit Profiles (continued)

AT2702S

Front panel

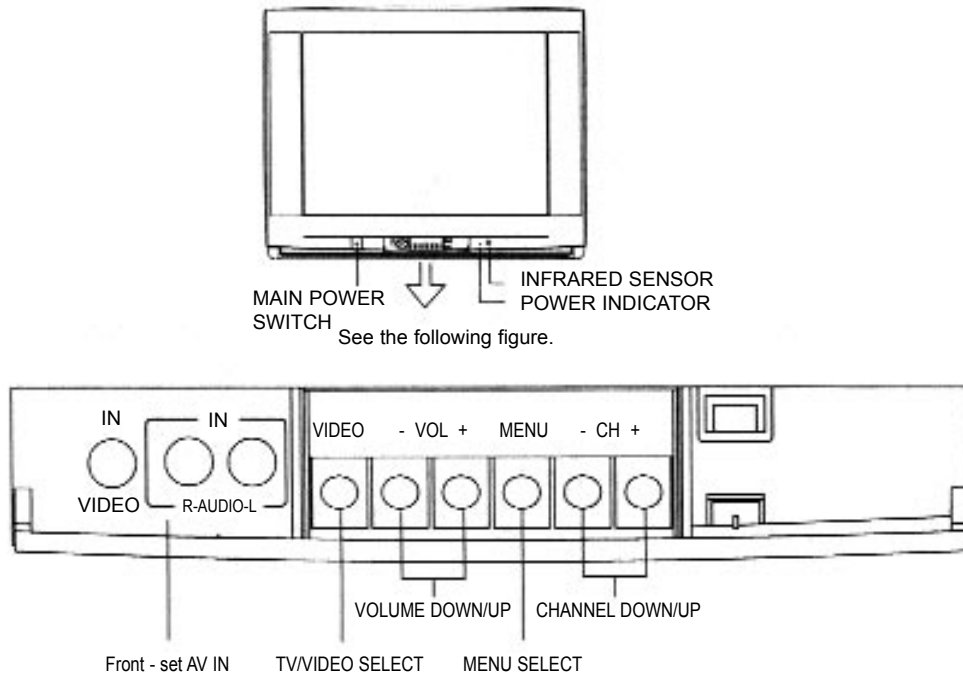

Rear panel

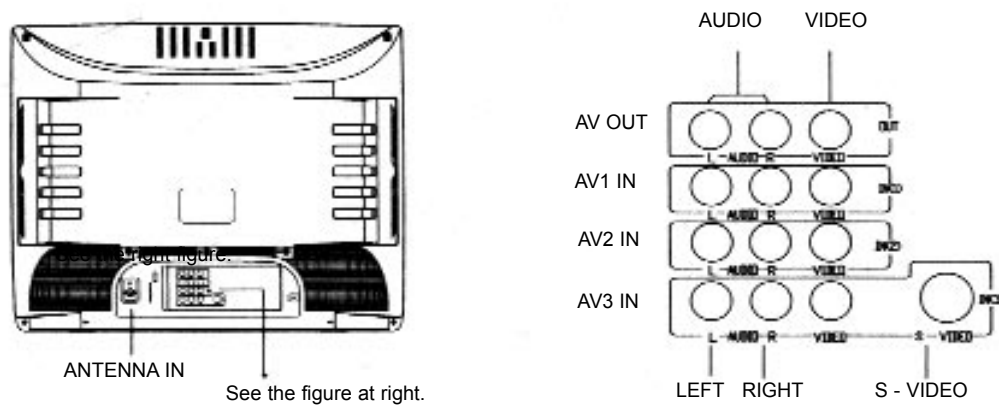

Remote Control Features

Function (p. 11,)	Used for volume control and child lock
100+ (p. 11)	Used for channels over 99
Timer (p. 13)	Accesses the Timer menu
Arrows (p. 12, 13, 14, 15)	Used to navigate the TV menus
Scan (p. XX)	The TV will scan all active channels
Picture (p. XX)	Selects the various Picture Modes
Recall (p. XX)	Returns to the last channel viewed
CC (p. XX)	Activates Closed Captioning
Standby (p. 11)	Turns the TV On or Off
Keypad (p.11)	Used to select channels by number
CH +/- (p. 11)	Used to adjust the current channel
VOL +/- (p. 11)	Used to adjust the volume up or down
Display (p. 11)	Brings up the TV display
Menu (p. 12, 13, 14, 15)	Accesses the TV menus
Stereo (p. XX)	Cycles between Mono/Stereo modes
Sound (p. XX)	Selects various Sound modes
Mute (p. 11)	Mutes or restores the TV volume
Video (p. XX)	Cycles through the Video/Air modes

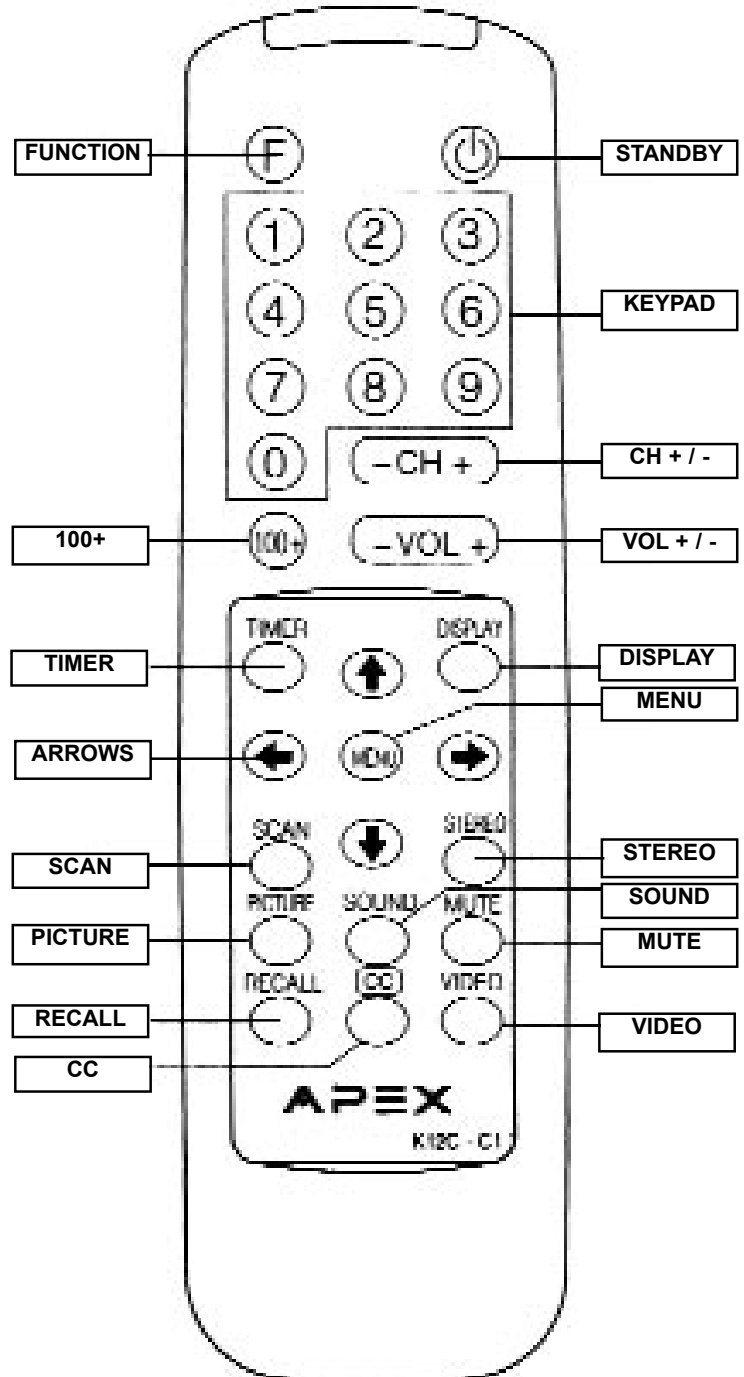

INSTALLATION

- Please read the safety instructions in this manual completely before installation.
- Install your TV in an area where direct sunlight will not fall upon the screen.
- Soft, indirect light is best for television viewing.
- Allow enough space (at least 4 in.) between the TV and any walls or enclosures for proper ventilation.
- The optimum television viewing distance is 5-7 times the screen's vertical length:
20" - 8 to 13 feet 24" - 10 to 14 feet 27" - 13 to 16 feet

Auto-Degaussing

Color television can be easily affected by magnetism, which shows as color distortion on the screen. If your TV is affected by nearby magnetic components or appliances, press the MAIN POWER SWITCH on the front of the TV to power off your TV for at least 1 hour. The built-in auto-degaussing circuit will eliminate the magnetic interference.

Connecting the Antenna

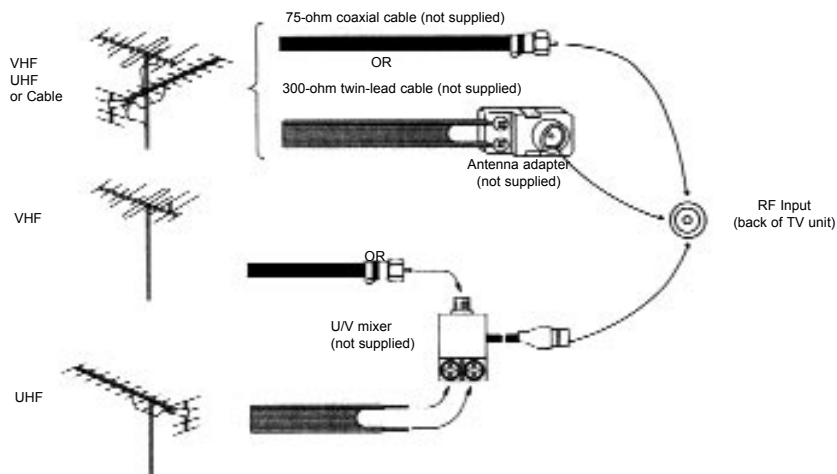

Notes:

1. It is recommended that a 75 ohm coaxial cable be used in order to eliminate interference and noise which may occur due to nearby radio transmissions.
2. The antenna cable should not be tied together with other wiring.
3. Set up a lightning rod and check it regularly when an outdoor antenna is used.

Remote Control Battery Installation

1. Remove the battery compartment lid.
2. Insert two AAA batteries (included.) Make sure the positive (+) and negative (-) polarities are correctly aligned.
3. Reattach the battery lid.

Notes:

1. Alkaline batteries are recommended for longer life.
2. Always replace both batteries at the same time.
3. Do not expose batteries to fire or break them open.
4. To avoid battery leakage, remove batteries from the remote control when it is not to be used for a long period of time or the batteries are exhausted.

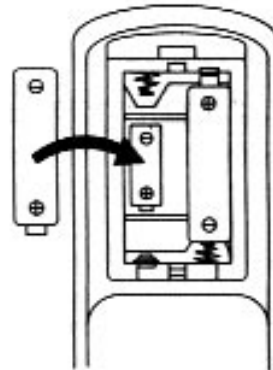

INSTALLATION (continued)

To Connect External Equipment

The following are diagrams showing basic instructions for attaching external equipment, like a VCR or DVD player, to your TV set. Please refer to operation manuals of external audio/video equipment that will be connected to your set for additional instructions. PLEASE TURN ALL POWER IS OFF BEFORE CONNECTING DEVICES TOGETHER.

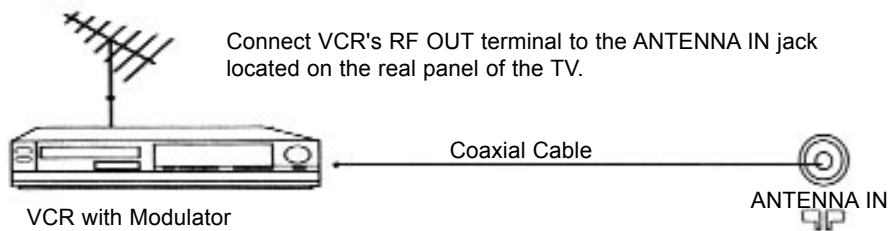

Input From Device to TV

AUDIO/VIDEO OUT

Do NOT connect the yellow composite video terminal if using the S-Video terminal.

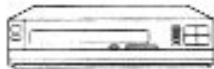

DVD Player

The front or side terminals may be easier to use with a camcorder. The connections are identical.

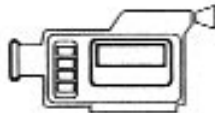

Camcorder



OR

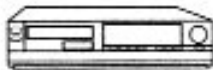
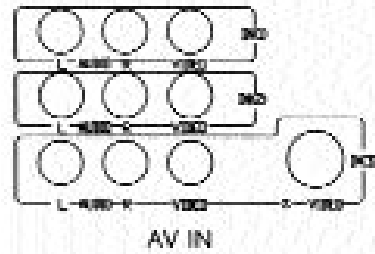

VCR

Actual back of TV may vary. Please see pgs. 9-12 for your TV's back panel illustration.

Output From TV to Device

AUDIO/VIDEO IN

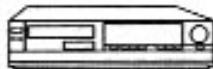
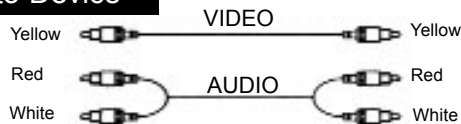

VCR

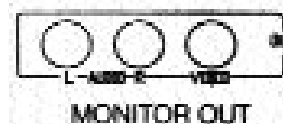

FUNCTIONS & FEATURES

Power On/Off

1. Power On

Plug in the supply cord, and press the MAIN POWER SWITCH on the front of the TV to turn the power on. A channel number will appear on the upper right corner of screen. Also, the red indicator light on the TV will come on.

2. Standby (Soft Off)

With the main power ON, press the Standby button on the remote control. This will put the TV in "Standby" or soft off mode. The red indicator light on TV set will NOT turn off. To turn the TV on again, simply press the Standby button on the remote control, or press one of the CH +/- buttons on the TV set.

3. Power Off

With the power ON or in Standby mode, press the MAIN POWER SWITCH on the front of the TV set to completely turn off the power to the TV set. The red indicator light on the front of the TV set will turn off.

4. Auto Off

If the TV is ON (not Standby mode), and there is no signal is coming into the TV set for 15 minutes, the TV will turn off.

Note:

Avoid switching the TV on and off frequently or rapidly. Doing so may shorten the life span of internal components.

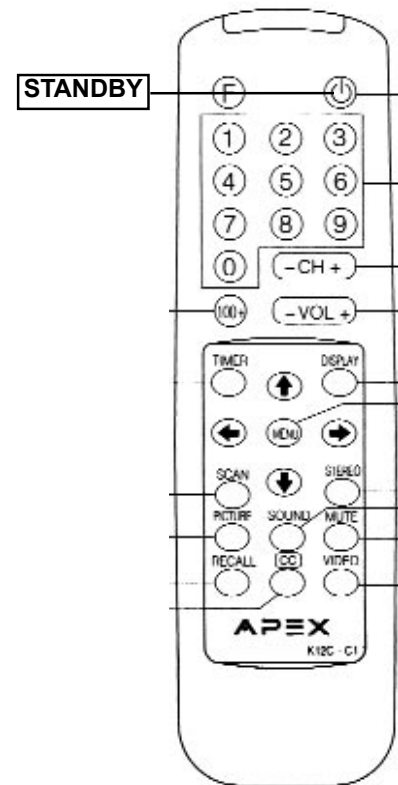

On Screen Display

Tuner Mode

Pressing the DISPLAY button on the remote control while in Tuner mode will cause the channel number, antenna mode, and clock to appear in the upper right of the screen. To remove, press DISPLAY again.

Video Mode

Pressing the DISPLAY button on the remote control while in Video Mode will cause the word "Video" and the clock to be displayed. Press DISPLAY again to remove. The word "Video" will continue to be displayed if no video signal is present.

Basic Functions

Changing the Channel

While in Tuner mode, press the CH +/- key to change the channel, or use the numeric keypad to enter a new channel. For channels over 99, press the 100+ button and then the last two digits of the channel.

Adjusting the Volume

To adjust the volume, press the VOL +/- key. Also, you may press the FUNCTION ASSIST key along with the VOL +/- key to adjust the volume in increments of 4.

Muting the Volume

To mute the volume, press the MUTE key. To restore the volume, press MUTE again or press the VOL +/- key.

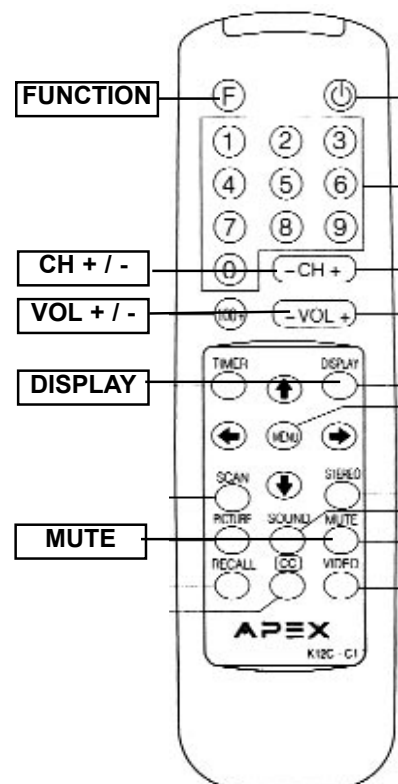

FUNCTIONS & FEATURES (continued)

Function Selection Menus

All Function menus can be accessed by pressing the "Menu" key on the remote control, or using the "Menu" key on the TV set. When finished, press the "Menu" key until the screen clears.

Picture Menu

Access

From the Main menu screen, press the "Menu" key until "Picture" is highlighted in red. Press the left or right arrow keys to access this menu.

Features

This menu allows you to adjust the various picture settings. Use the up & down arrow keys to move between the various settings, and the left & right arrow keys to adjust them. When finished, press the "Menu" key to return to the main menu.

TINT:	-31 (more greenish) to +31 (more purplish)
BRIGHTNESS:	0 (dimkest) to 63 (brighter)
CONTRAST:	0 (less contrast) to 63 (more contrast)
COLOR:	0 (less color) to 63 (more color)
SHARP:	0 (less sharpness) to 63 (more sharpness)

Picture	
+	Tint 00
	Brightness 32
	Contrast 32
	Color 32
	Sharp 32

Audio Menu (AT2402S, AT2702S only)

Access

From the Main menu screen, press the "Menu" key until "Audio" is highlighted in red. Press the left or right arrow keys to access this menu.

Features

This menu allows you to adjust the various audio settings. Use the up & down arrow keys to move between the various settings, and the left & right arrow keys to adjust them. When finished, press the "Menu" key to return to the main menu.

BASS:	0 (less Bass) to 63 (more Bass)
TREBLE:	0 (less Treble) to 63 (more Treble)
BALANCE:	0 (Left Dominance) to 63 (Right Dominance)
SURROUND:	Off; Low (slight surround effect); High (marked surround effect)

Audio	
Bass.....	31
Treble.....	31
Balance.....	30
Surround	Low

Tuner Menu

Access

Press the "Menu" key until "Tuner" is highlighted in red. Press the left or right arrow key to access this menu.

Note: This menu is only accessible while the TV is in Tuner mode.

Use the up & down arrow keys to move between the various settings. When finished, press the "Menu" key to return to the main menu.

Channel: This feature allows you to select the channel being displayed. Either use the left & right arrow keys or the numeric keypad to select the channel.

Add/Erase: This feature is used to either add or remove the presently selected channel from the active channel list, which is used by the TV when CH +/- is pushed. Use the left & right arrow keys to select ADD or ERASE.

Antenna : This feature sets the TV tuner to an Air antenna or a Cable antenna. Please use Air mode when using an over-the-air antenna; use Cable mode for a cable hookup. Use the left & right arrow keys to select between the two options.

Auto Program: This feature will automatically add channels to your channel list, based on the presence of a signal. If a signal is detected, that channel will be added. If there is no signal detected then the channel will not be added. Use the right arrow key to start the process; use the left arrow key to stop the process.

Tuner	
+	Channel
	Add/Erase
	Antenna
	Auto Program
	2
	Add
	Air
■	Stop
■	Start
■	

FUNCTIONS & FEATURES (continued)

Timer Menu

From the Main Menu screen, press the “Menu” key on the remote control until “Timer” on the main screen is highlighted in red. Press the left or right arrow key to enter this menu.

Time

This feature allows you to set the clock on the TV. With “Time” highlighted in red, use the left & right arrow keys to set the hour. Once the hour has been set, press the down arrow key to move to minutes, and then set them as well. Repeat this process for the AM/PM aspect also. Please note that on some models, the number “0” is used instead of “12.” Press the down arrow again to move on to the next feature, or simply let the display disappear after six seconds.

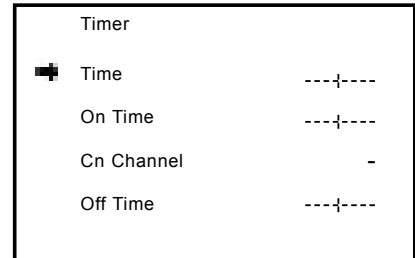

On Time

This feature will allow you to program the TV to turn on at a preset time, and to a preset channel (see “on Channel”, below.) Use the down arrow key to highlight this feature in red. Next, use the left & right arrow keys to set the hour that you wish for the TV to come on. Use the down arrow key to move to minutes, and then set them using the left & right arrow keys to set them as well. Repeat this process for the AM/PM aspect also. Please note that some models use the number “0” instead of “12.” Press the down arrow to move to the next feature, or simply let the display disappear after six seconds.

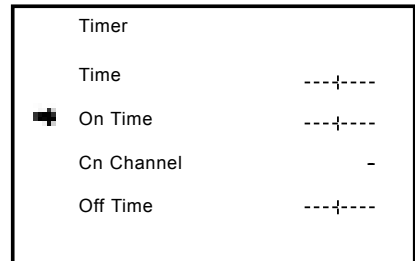

On Channel

This feature ties into the “On Time” feature described above. Use the down arrow key to highlight this feature in red. Next, use the left & right arrow keys, or the numeric keypad, to set the channel that the TV set will be on when the timer activates. Press the down arrow key to move to the next feature, or simply let the display disappear after six seconds.

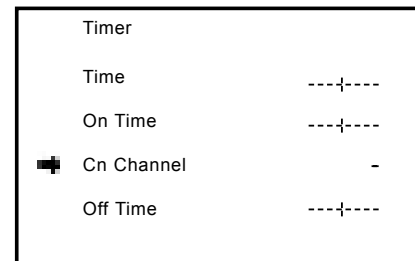

Off Time

The procedure to set this feature is the same as the procedure described above in “On Time.” Use the down arrow key to highlight this feature in red. Next, use the left & right arrow keys to set the hour that you wish for the TV to turn off. Use the down arrow key to move to minutes, and then set them using the left & right arrow keys to set them as well. Repeat this process for the AM/PM aspect also. Please note that some models use the number “0” instead of “12.” Press the down arrow to move to the next feature, or simply let the display disappear after six seconds.

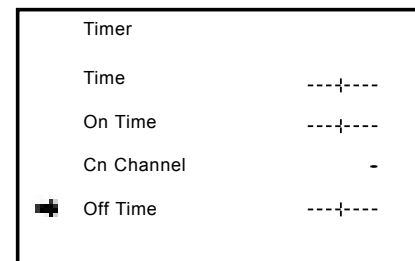

FUNCTIONS & FEATURES (continued)

System Menu

From the Main Menu screen, press the "Menu" key until "System" is highlighted in red. Press the right arrow key to enter this menu. Use the up & down arrow keys to move between the various feature selections in this menu.

Language

This feature will allow you to change the language that is used for the on screen display. With "Language" highlighted in red, use the left & right arrow keys to select which of the three languages you wish to use - English (Eng.), Spanish (Esp.), or French (Fra.)

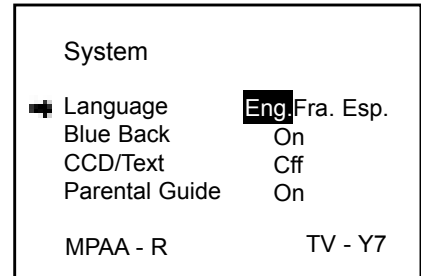

Blue Back

This feature, when activated, will display a blue background on your TV screen when there is no signal present. With "Blue Back" highlighted in red, use the left or right arrow keys to select between On or Off.

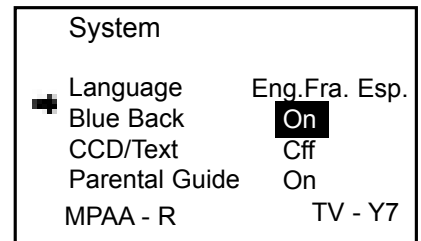

Closed Caption

When the Closed Captioning system is turned on, your APEX television can decode and display the Closed Captioning signal. Closed Captioning provides an on screen display of the dialogue, narration, and sound effects of a TV program. Closed Captions will be displayed at either the top or bottom of the screen.

With the Text mode selected, our APEX television will decode and display any teletext signal that is being transmitted with the TV program. This information is usually not related to the program itself. Text will be displayed on a portion of the TV screen.

With "Closed Captioning" highlighted in red, use the left & right arrow keys to select one of the four Closed Captioning selections (CC 1-4), or one of the four Text selections (T1-4). Setting this feature to Off will turn off any Closed Captions.

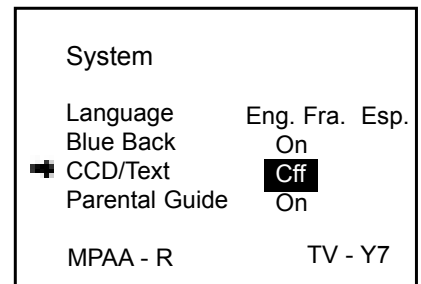

Notes

A Closed Caption signal may not display under the following conditions:

- When viewing a dubbed video tape
- When there is poor or weak signal reception
- When the signal is changed or altered (due to interference)
- When the program does not have a Closed Caption or Text signal to decode

FUNCTIONS & FEATURES (continued)

System Menu (continued)

Parental Guide

This feature allows parents to block certain programs from being viewed, based on the programs' rating. In order to access this menu, you must first enter a pass code. The factory default is **6688**. With "Parental Guide" highlighted in red, use the numeric keypad to enter the pass code. If this turns the Parental Guide "Off," press the right arrow key until Parental Guide in "On." With Parental Guide "On," press the right arrow key to access the TV Rating grid.

TV Rating Grid

Using the up & down arrow keys to navigate between the ratings, press the "Menu" key to block out a particular rating completely. Or, if you wish, press the down arrow key to highlight an individual rating (anywhere a "U" is displayed in the middle of the grid.) Pressing the "Menu" key with one of these individual ratings highlighted will block only programs that feature that particular aspect. See the TV rating diagram at right for an example. TV ratings are defined in the charts below:

Age	Defined as	Contents	Defined as
TV - Y	All Children	FV	Fantasy Violence
TV - Y7	Directed to Older Children (over 7)	D	Sexual Dialogue
TV - G	General Audience	L	Adult Language
TV - PG	Parental Guidance Suggested	S	Sexual Situations
TV - 14	Parents Strongly Cautioned	V	Violence
TV - MA	Mature Audience Only		

MPAA Rating Grid

Press the right arrow key while in the TV Rating grid to access this grid. Use the up & down arrow keys to navigate between the MPAA ratings. Pressing the "Menu" key with a rating highlighted will block that particular rating from being shown on this TV. A "B" will show in red next to the blocked rating. Please note that blocking a lower rating (for example, PG) will block all higher ratings (PG-13, R, NC-17, X.)

Pass Code Menu

This menu allows you to change the access code for the Parental Guide functions of the TV set. Pressing the "Menu" key when Pass Code Control is highlighted. This will turn on or off the Pass Code function. With the Pass Code function ON, you can also change the Pass Code. Use the down arrow key to highlight "Pass Code," then enter the new Pass Code using the numeric keypad. Press the left arrow key when finished.

Notes

1. The factory default pass code of 6688 is also the override code, in case you forget your new pass code.
2. The factory defaults have TV-MA and MPAA-X ratings blocked.

TV Rating Grid

TV-Rating						
Rating	FV	D	L	S	V	
TV-Y	U					
TV-Y7	U	U				
TV-G	U					
TV-PG	U	+	U	U	U	U
TV-14	U		U	U	U	U
TV-MA	U			U	U	U

MPAA Rating Grid

MPAA - Rating	
Movie	Rating
G	U
PG	U
PG-13	U
R	U
NC-17	U
X	U

TROUBLESHOOTING GUIDE

Check the following guide for a possible correction to a problem before contacting customer service.

Check FAQ at our website: www.apexdigitalinc.com.

Symptoms	Correction
No power	<ul style="list-style-type: none"> • Connect the power plug into the wall outlet securely.
No picture	<ul style="list-style-type: none"> • Verify the connection from the DVD/VCR video output to the TV video input is secure. Then switch TV to the appropriate Video mode. • Verify coaxial cable from antenna is connected to RF IN.
No sound	<ul style="list-style-type: none"> • Connect the audio cables into the terminals securely. • Verify the connection from the DVD/VCR audio output to the TV audio input. Then switch to the appropriate mode on the receiver. Refer to your audio amplifier owner's manual. • Mute feature may be enabled.
No TV signal	<ul style="list-style-type: none"> • Check whether your receiver is set to the TV mode. • Check whether the antenna is well connected to the TV receiver. Unplug the TV from the wall for 30 seconds, then plug in and try again. Unplug the antenna connection from the back of the TV, unplug the TV from the wall, wait 30 seconds, then try again.
Stripe or purple interference appears in the screen.	<ul style="list-style-type: none"> • Interference may come from high frequency sources such as a broadcasting station, poor ground connection in cable used, or non shielded audio speakers too close to the picture tube.
Picture becomes snowy.	<ul style="list-style-type: none"> • Check the antenna lead wire to see if it has open circuit or not. • Check the connection of antenna lead wire to the TV set input. • Check whether there is any damage to antenna.
Picture with multi-image	<ul style="list-style-type: none"> • Change the direction of antenna to minimize the multi image. • The video frequency radiated from TV station can be reflected by tall buildings, high tower, etc.
TV channel not received	<ul style="list-style-type: none"> • Make sure the Air/Cable setting is correct. • Channel may be locked with the block channel feature, such as Parental Control. • Check Add/Erase feature, as channel may have been erased during set up.
Black box appears on screen.	<ul style="list-style-type: none"> • Closed Caption to Text feature may be active.
Remote control doesn't operate.	<ul style="list-style-type: none"> • Batteries may be weak. Replace batteries. • Make sure remote sensor is not blocked including deflection from curved glass cabinet.

LIMITED UNITED STATES WARRANTY AT2002S, AT2402S, AT2702S

Apex Digital, Inc. makes the following limited warranties. These limited warranties extend to the original consumer purchaser or any person receiving this product as a gift from the original consumer purchaser and to no other purchaser or transferee.

Limited Ninety (90) Days Warranty (AT2702S Model ONLY)

Apex Digital, Inc. warrants this product and its parts against defects in material or workmanship for a period of ninety (90) days after the date of original retail purchase. During this period Apex Digital, Inc. will repair or replace a defective part or product at their option, with a new or refurbished part or product, without charge to you. Authorized Apex Digital, Inc. Service Center personnel will come to your home when warranty service is required. Depending on the type of repair required, the service will either be performed in your home or the set will be taken to the Authorized Apex Digital, Inc. Service Center's repair facility for repair and then returned to your home at no cost to you.

Limited Ninety (90) Days Warranty (AT2002S, AT2402S Models ONLY)

Apex Digital, Inc. warrants this product and its parts against defects in material or workmanship for a period of ninety (90) days after the date of original retail purchase. During this period Apex Digital, Inc. will repair or replace a defective part or product at their option, with a new or refurbished part or product, without charge to you. You must deliver the entire product to an Authorized Apex Digital, Inc. Service Center. You are responsible for all packing, transportation and insurance charges for the set to and from the Service Center.

Limited One (1) Year Warranty

Apex Digital, Inc. further warrants the parts in this product against defects in materials or workmanship for a period of one (1) year after the date of original retail purchase with exception of the remote control which is guaranteed for ninety (90) days. During this period Apex Digital, Inc. will replace a defective part with a new or refurbished part without charge to you, except that if a defective part is replaced after ninety (90) days from the date of original retail purchase, you are responsible to pay all labor charges involved in the part(s) replacement including all packing, transportation and insurance charges for the set to and from the Service Center.

Limited Two (2) Years Warranty

Apex Digital, Inc. further warrants the picture tube in this product against defects in materials or workmanship for a period of two (2) years after the date of original retail purchase. During this period Apex Digital, Inc. will replace the defective picture tube at their option with a new or rebuilt picture tube or at their option replace the entire product with a new or refurbished product at no charge to you; if however the defective picture tube or product is replaced after one (1) year from the date of the original retail purchase, you pay all labor, packing and transportation charges involved in the replacement.

Rental Product

The warranty for a rental product begins with the original date of receipt by the rental firm.

- Your Responsibility
- The above warranties are subject to the following conditions:
- You must retain your bill of sale to provide proof of purchase.
- All warranty service of this product must be made by an Authorized Apex Digital, Inc. Service Center.
- These warranties are effective only if the product is purchased and operated in the U.S.A., Hawaii and Puerto Rico. Labor service charges for set installation, setup, adjustment of customer controls and installation or repair of any type of antenna or cable systems are not covered by this warranty. Reception problems caused by inadequate antenna or cable system are your responsibility.
- Warranties extend only to defects in materials or workmanship as limited above and do not extend to any product or parts which have been lost or discarded by you or damage to product or parts caused by misuse, accident, damage caused by Acts of God, such as lightning or fluctuations in electrical power, improper installation, improper maintenance or use in violation of instructions furnished by us; or to product which has been modified or had the serial number removed, altered, defaced or rendered illegible. Warranties do not cover cosmetic damages or lost accessories.

How to Obtain Warranty Service

If after following all the operating instructions in this manual and reading the section TROUBLESHOOTING you find that service is necessary:

1. Should it be necessary contact our Customer Service Center directly call 866 4 APEXINC (866 427 - 3946), Mon - Fri 8am - 5pm (Pacific Time).
2. After obtaining the requested information, you must present your bill of sale to the Authorized Service Center to obtain warranty service.
3. Authorized Apex Digital, Inc. Service personnel will come to your home when warranty service is required. Depending on the type of repair required, the service will either be performed in your home or the set will be taken to the Authorized Service Center's facility for repair and then returned to your home.

Limitations

All warranties implied by state law, including the implied warranties of merchantability and fitness for a particular purpose, are expressly limited to the duration of the limited warranties as set forth above. With the exception of any warranties implied by state law as hereby limited, the foregoing warranty is exclusive and in lieu of all other warranties, guarantees, agreements and similar obligations of manufacturers or seller with respect to the repair or replacement of any parts. In no event shall Apex Digital, Inc. be liable for consequential or incidental damages.

No person, agent, distributor, dealer or company is authorized to change, modify or extend the terms of these warranties in any manner whatsoever. The time within which action must be commenced to enforce any obligation of Apex Digital, Inc. arising under this warranty or under any statute, or law of the United States or any state thereof, is hereby limited to ninety (90) days from the date you discover or should have discovered the defect. This limitation does not apply to implied warranties arising under state law.

This warranty gives you specific rights and you may also have these rights which may vary from state to state. Some states do not allow limitation on how long an implied warranty lasts, when an action may be brought, or the exclusion or limitation of incidental or consequential damages, so the above provisions may not apply to you.

Free Manuals Download Website

<http://myh66.com>

<http://usermanuals.us>

<http://www.somanuals.com>

<http://www.4manuals.cc>

<http://www.manual-lib.com>

<http://www.404manual.com>

<http://www.luxmanual.com>

<http://aubethermostatmanual.com>

Golf course search by state

<http://golfingnear.com>

Email search by domain

<http://emailbydomain.com>

Auto manuals search

<http://auto.somanuals.com>

TV manuals search

<http://tv.somanuals.com>