

USER'S MANUAL
32" LCD TELEVISION

03/2009



CAUTION
RISK OF ELECTRIC SHOCK
DO NOT OPEN



Safety:

TO REDUCE THE RISK OF ELECTRICAL SHOCK DO NOT REMOVE COVER (OR BACK). NO USER SERVICEABLE PARTS ARE INSIDE. REFER TO QUALIFIED PERSONNEL ONLY.



The lightning flash with arrowhead symbol, within an equilateral triangle, is intended to alert the user to the presence of uninsulated "dangerous voltage" within the product's enclosure that may be of sufficient magnitude to constitute a risk of electric shock to persons.



The exclamation point within an equilateral triangle is intended to alert the user to the presence of important operating and maintenance (servicing) instructions in the literature accompanying the television.

WARNING:

TO PREVENT FIRE OR SHOCK HAZARDS, DO NOT EXPOSE THIS PRODUCT TO RAIN OR MOISTURE.

NOTE TO CABLE/TV INSTALLER:

This reminder is provided to call the CATV system installer's attention to Article 820-40 of the National Electric Code (U.S.A.). The code provides guidelines for proper grounding and, in particular, specifies that the cable ground shall be connected to the grounding system of the building, as close to the point of the cable entry as practical.

FCC REGULATORY INFORMATION:

This television has been tested and found to comply with the limits for a Class B digital device, pursuant to Part 15 of the FCC Rules. These limits are designed to provide reasonable protection against harmful interference in a residential installation. This television generates, uses and can radiate radio frequency energy and, if not installed and used in accordance with the instructions, may cause harmful interference to radio communications. However, there is no guarantee that interference will not occur in a particular installation. If this television does cause interference to other electronic equipment, which can be determined by turning the television off and on, then the user is encouraged to try to correct the interference by one or more of the following measures:

- Reorient or relocate the receiving antenna.
- Increase the separation between the equipment and television.
- Connect the equipment into an outlet on a circuit different from that to which the television is connected.
- Consult your dealer or an experienced radio/TV technician for assistance.

Any changes or modifications not expressly approved by the party responsible for compliance may void the user's authority to operate the equipment.

Important safeguards for you and your new TV

Observing the simple precautions discussed in this booklet will provide you with many years of enjoyment and safe operation. This product complies with all applicable U.S. Federal safety requirements, and those of the Canadian Standards Association.

1. Read & Follow Instructions

All safety and operating instructions should be read and followed before the TV is operated.

2. Retain Instructions

The safety and operating instructions should be retained for future reference.

3. Heed Warnings

All warnings on the TV and in the operating instructions should be adhered to.

4. Cleaning

Unplug the TV from the wall outlet before cleaning. Do not use liquid cleaners or aerosol cleaners. Use a soft and slightly damp cloth for cleaning.

5. Water and Moisture

Do not use this TV near water, for example, near a bathtub, wash bowl, kitchen sink, or laundry tub, in a wet basement, or near a swimming pool.

6. Accessories Carts and Stands

Do not place this TV on a slippery or tilted surface, or on an unstable cart, stand, or table. The TV may slide or fall, causing serious injury to a child or adult, and serious damage to the TV.

7. Transporting the Television

A TV and cart combination should be moved with care. Quick stops, excessive force, and uneven surfaces may cause the TV and cart combination to overturn.

8. Ventilation

Slots and openings in the cabinet are provided for ventilation and to ensure reliable operation of the TV and to protect it from overheating, and these openings must not be blocked or covered. The openings should never be blocked by placing the TV on a bed, sofa, rug, or other similar surface. The TV should not be placed in a built-in installation such as a book-case or rack unless proper ventilation is provided.

9. Power Sources

This TV should be operated only from the type of power source indicated on the marking label. If you are not sure of the type of power supply to your home, consult your electronics retailer or local power company.

10. Power-Cord Polarization

This TV is equipped with a three-wire grounding type plug, a plug with a third (grounding) pin. This plug will only fit into a grounding-type power outlet. This is a safety feature. If you are unable to insert the plug into the outlet, the contact your electrician to replace your obsolete outlet. Do not defeat the safety purpose of the grounding-type plug.

11. Power-Cord Protection

Power-supply cords should be routed so that they are not likely to be walked on or pinched by items placed upon or against them, paying particular attention to cords at plugs, convenience receptacles, and the point where they exit from the TV.

12. Lightning

For added protection for the TV during a lightning storm, or when it is left unattended and unused for long periods of time, unplug it from the wall outlet and disconnect the antenna or cable system. This will prevent damage to the TV from lightning and power-line surges.

13. Outdoor Antenna Grounding

If an outside antenna or cable system is connected to the TV be sure the antenna or cable system is grounded so as to provide some protection against voltage surges and built up static charges. Article 810 of the National Electrical Code (U.S.A.), ANSI/ NFPA 70 provides information with regard to proper grounding of the mast and supporting structure, grounding of the lead-in wire to an antenna discharge unit, size of grounding conductors, location of antenna-discharge unit, connection to grounding electrodes, and requirements for the grounding electrode.

Example of Grounding According to National Electrical Code Instructions

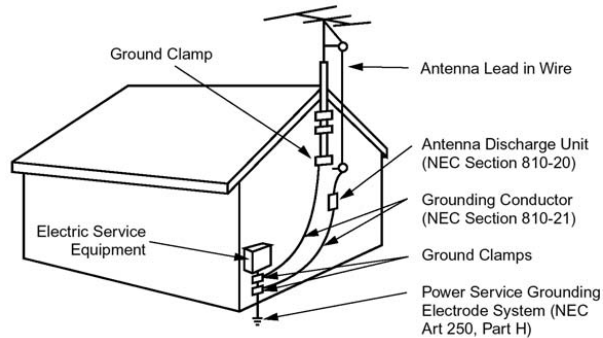

NEC - National Electrical Code

14. Power Lines

An outside antenna system should not be located in the vicinity of overhead power lines or other electric light or power circuits, or where it can fall on to power lines or circuits. When installing an outside antenna system, extreme care should be taken to keep from touching such power lines or circuits as contact with them might be fatal.

15. Overloading

Do not overload wall outlets and extension cords as this can result in a risk of fire or electric shock.

16. Object and Liquid Entry

Never push objects of any kind into this TV through openings as they may touch dangerous voltage points or short-out parts that could result in a fire or electric shock. Never spill liquid of any kind on or inside the TV.

17. Servicing

Do not attempt to service this TV yourself as opening or removing covers may expose you to dangerous voltage or other hazards. Refer all servicing to qualified service personnel.

18. Damage Requiring Service

Unplug from the wall outlet and refer servicing to qualified service personnel under the following conditions:

- a. If the power-supply cord or plug is damaged.
- b. If liquid has been spilled, or objects have fallen into the product.
- c. If the TV has been exposed to rain or water.
- d. If the TV does not operate normally by following the operating instructions. Adjust only those controls that are covered by the operating instructions as an improper adjustment of other controls may result in damage and will often require extensive work by a qualified technician to restore the product to its normal operation.
- e. If the TV has been dropped or the cabinet has been damaged.
- f. If the TV exhibits a distinct change in performance.

19. Replacement Parts

When replacement parts are required, be sure that only an authorized service technician has used replacement parts specified by Apex Digital or have the same characteristics as the original part. Unauthorized substitutions may result in fire, electric shock, or other hazards and void any warranty.

20. Safety Check

Upon completion of any service or repairs to this TV, ask the service technician to perform safety checks to determine whether the product is in proper operating condition.

21. Wall Mounting

The TV should be mounted to a wall only by a professional. The TV may slide or fall, causing serious injury to a child or adult, and serious damage to the product. Warranty shall be voided.

22. Heat

The TV should be situated away from heat sources such as radiators, heat registers, stoves, or other products (including amplifiers) that produce heat.

Getting Started

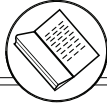

Safety Instructions.....	1 - 3
Table of Contents.....	4
Introduction/ What's In The Box.....	5

Remote Control

Remote Control Battery Install.....	6
Remote Control Overview.....	7

TV Overview

Front & Side Panel.....	8
Rear Panel.....	9
Pedestal Base Removal.....	9

Initial Setup Before Use



Installation

Connection to Antenna & Cable/ Satellite.....	10
Connection to HDMI Inputs.....	11
Connection to Component (YPbPr) Inputs.....	12
Connection to Composite AV / S-Video Inputs.....	13
Connection to a Personal Computer.....	14
Connection to a Home Theater System.....	15
Connection to a Receiver / Amp.....	16

Initial TV Setup

TV Channel Setup & Channel Auto Scan	17
--	----

Menu Adjustments



Picture Menu

Contrast.....	18
Brightness.....	18
Color.....	18
Tint.....	18
Sharpness.....	18
Color Temperature.....	18

Audio Menu

Bass.....	19
Treble.....	19
Balance.....	19
Surround.....	19
AVC.....	19
SPDIF.....	19
Audio Language.....	19

Date & Time Menu

Time Zone.....	20
Daylight Savings Time.....	20

Set Up Menu

Menu Language.....	21
Transparency.....	21
Zoom.....	21
Noise Reduction.....	21
XVS (Enhanced Black Detail).....	21
Restore Default	21
Closed Caption.....	22
Personal Computer.....	23

Parental Menu

U.S. TV and Movie Ratings.....	24
Canadian TV and Movie Ratings.....	25

TV Menu

Favorite.....	26
Add/Delete Channel.....	26
Channel Label.....	26
DTV Signal.....	26

Zoom Mode

.....	27
-------	----

Misc Information

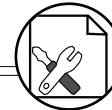

Specification.....	28
Troubleshooting.....	29
Index.....	30
Warranty.....	31

Thank you for purchasing the Apex LD 3249 HD Television. It has been designed to enjoy today's high definition television experience. With a display resolution of 1366 x 768 (720p) you are assured of one of the finest quality televisions available today. View HDTV and digital broadcasts (if available in your area) over-the-air when connected to an antenna. Choose an outdoor antenna for the best possible reception. Visit www.antenna.org.

Your television offers many digital and analog inputs. Three (3) High Definition Multimedia Interface (HDMI) interconnects offer the purest audio and video digital signal when connected to compatible HD sources (ie: HD set-top box, high definition DVD player, gaming console).

Other video connections available include two (2) sets of HD component video, (2) composite input jacks, one S-Video input jack and one VGA terminal for connection to a computer. A coaxial digital audio (SPDIF) jack is included to connect through your home amplifier/receiver to provide a spectacular home theater experience.

3D Digital noise reduction digitally reduces image noise while "film-mode" detection adjusts the picture, providing a more natural looking and clearer image.

We recommend that you read the user manual thoroughly before use to familiarize yourself with the installation and adjustment options available to you, thereby enjoying all the features of the LD3249 for many years to come.

Digital Television Transition Notice: This device contains a digital television tuner, so it should receive digital over the air TV programming, with a suitable antenna, after the end of full-power analog TV broadcasting in the United States on February 17, 2009. After February 17, 2009, a television receiver with only an analog broadcast tuner will require a converter box to receive full power over-the-air broadcasts with an antenna because of the Nation's transition to digital broadcasting. Analog-only TVs should continue to work as before to receive low power, Class A or translator television stations and with cable and satellite TV services, gaming consoles, VCRs, DVD players, and similar products. When a converter box is used with an older television receiver, a signal splitter might be necessary to continue to receive low-power analog broadcasts via an antenna. Information about the DTV transition is available from www.DTV.gov or 1-888-CALL-FCC, and from www.dtv2009.gov or 1-888-DTV-2009 for information about subsidized coupons for digital-to-analog converter boxes.

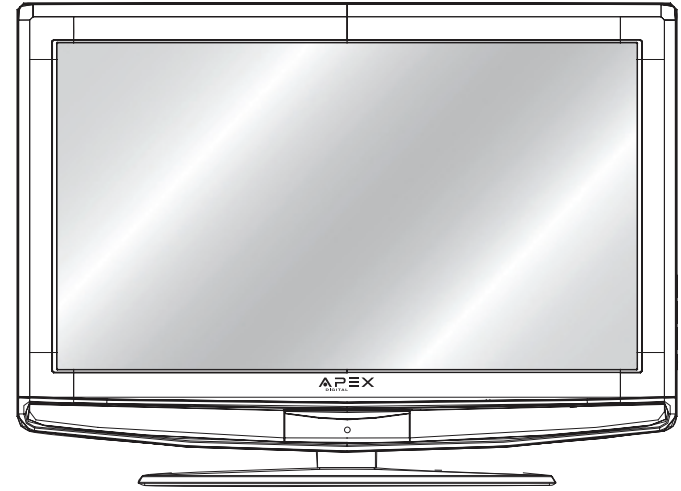

The **LD3249** package includes the following items:

- Remote Control
- AAA Batteries
- AC Power Cord
- Quick Start Guide
- User Manual

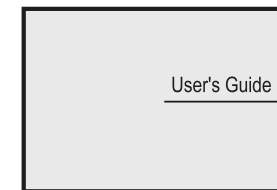

- Quick Start Guide



- Remote Control
- AAA Batteries x 2



- AC Power Cord

Your remote control handset is powered by two (2) AAA type batteries



- To insert batteries, turn the remote control over and remove the battery cover.



- Place two (2) AAA batteries into the compartment with correct polarity.



- Replace the cover.

- When pointed towards the television, the effective range is approximately 16 feet from the front of the IR receiver, 30° to the left and right, 20° up and down.
- To avoid damage from possible battery chemical leakage, remove the batteries if you do not plan to use the remote control handset for an extended period of time. Do not mix batteries of different age and/or type. Always discard used batteries safely.
- Do not expose remote control to liquids, direct sunlight or sources of excessive heat.
- The IR receiver will not work properly if TV is in direct sunlight, the remote control is pointed off-axis or an object is in the IR path.

NOTE: Improper use of batteries can result in a chemical leakage or explosion.

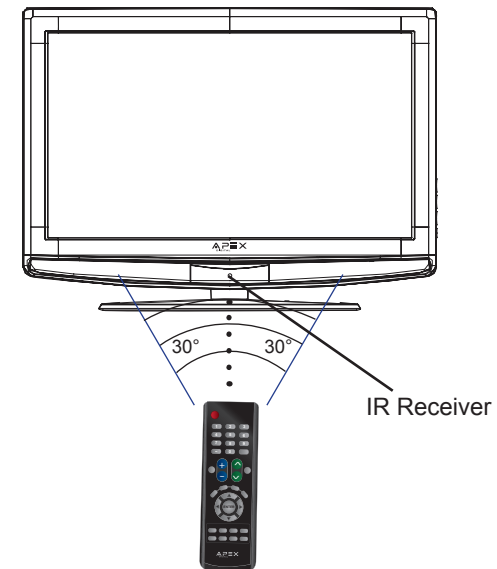

Functions can be controlled using the remote control handset

1. Power - To turn the LCD display ON or OFF (Standby) *Master power switch located on the rear of the TV must be turned ON.

2. Number Buttons / (-) - Press to select your desired television channel.

For example: to select a digital channel for channel 4, press 4-1 (if available).

3. Recall - Press to select between the current and previously viewed television channel.

4. Volume (+/-) - Adjust Volume UP or DOWN.

5. Channel (▲/▼) - Select Channel UP or DOWN.

6. Mute - Press to temporarily turn sound off. Press again to resume. An icon will display when Mute is active. (See pg. 8, 11-14)

7. Input - Press to select TV Input sources (TV, AV, S-Video, Component, HDMI, VGA).

8. Guide - Press to view scheduled programming for the current channel viewed (if available).

9. Favorite - Press to display a list of Favorite TV Channels you have added. (See pg. 26 for details)

10. Menu - Press to display the User menu. Press ▼▲◀▶ to navigate & make selections in the Picture, Audio, Time, Setup, Parental & TV menus. (See pg. 17-26 for details)

11. Exit - Press to exit the Menu after setting user preferences.

12. Arrow Buttons / Enter - Use ▼▲◀▶ to navigate and make selections. To confirm a selection, press ENTER.

13. Ch List - Press to display a list of channels saved in the TV tuner memory.

Use ▼▲◀▶ to highlight and make channel selection.

14. Zoom - Press to display or select viewable picture size options:

ZOOM:NORMAL > ZOOM:WIDE > ZOOM:ZOOM > ZOOM:CINEMA.

15. Sleep - Press to activate the sleep function to turn off the television automatically:

OFF > 5 Min > 10 Min > 15 Min > 30 Min > 45 Min >

60 Min > 90 Min > 120 Min > 180 Min > 240 Min.

16. Display - Press to display program information currently on screen.

17. CCD - Select Closed Caption subtitles. (if available) OFF > ON > CC ON MUTE. (See pg. 22 for details)

18. Picture - Press to display or select from various preset picture modes:

Personal > Standard > Dynamic > Movie. (See pg. 18 for details)

19. MTS (multi-channel TV sound) - Press to select a second audio channel (if available).

20. Audio - Press to select from various preset audio EQ settings:

Personal > Standard > Music > Movie. (See pg. 19 for details)

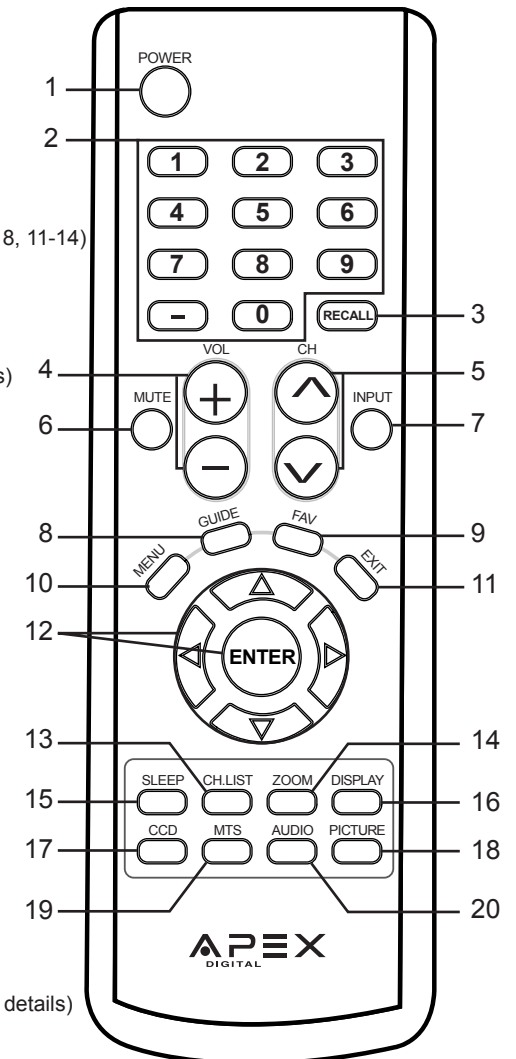

NOTE: When using the remote control, point it directly at the TV.

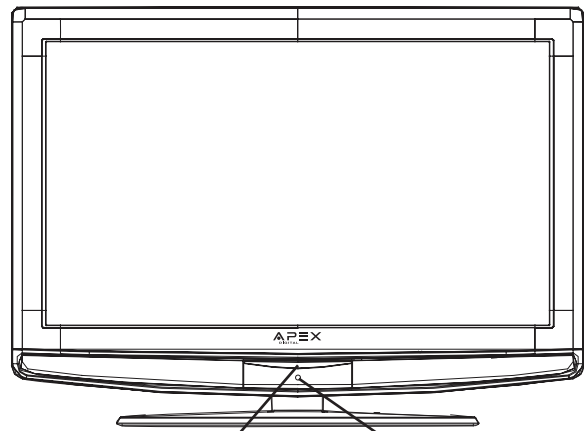

A soft blue light illuminates when television is powered ON

IR Receiver

Side Panel

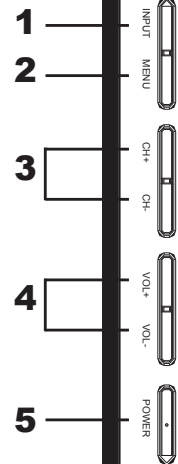

1. Input - After connecting your DVD, Cable Box, etc., select the appropriate input source to view. Press the INPUT button to display input options. Press ▼▲ buttons to highlight an input. Press ENTER to select.

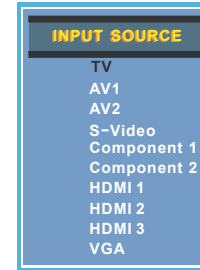

2. Menu - Press the MENU button to display and adjust your TV settings. Press again to turn the OSD (on screen display) OFF. To adjust settings from here, press CH+/CH- ▼▲ to navigate to a high-lighted setting then press VOL+/VOL- to select and adjust.

3. Channel (CH V/A ▼▲) - Press the ▼▲ buttons to select a channel in TV mode. These buttons are also used to adjust settings in the MENU mode.

4. Volume (VOL+/VOL- ▲▼) - Press the ▲▼ buttons to adjust volume up or down. These buttons are also used to adjust settings in the MENU mode.

5. Power - Press the POWER button turn the LCD display ON/OFF (standby). When the power is on, the blue LED illuminates. The screen image will appear within a few seconds.

NOTE: To turn OFF power completely, switch the Master Power button located on the rear of the television. When the Master Power switch is off, neither the remote control or television POWER button will function (See pg. 9 for details)

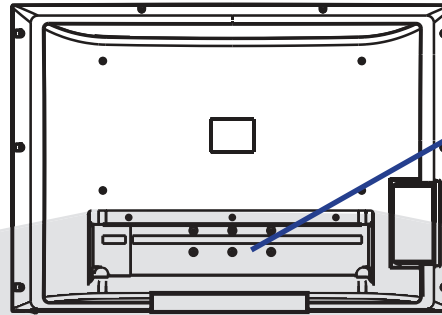

Disassembly of TV Pedestal

To remove the pedestal stand from the television, unscrew the (6) Philips head screws and slide the TV upward while securing the base.

TV REAR PANEL

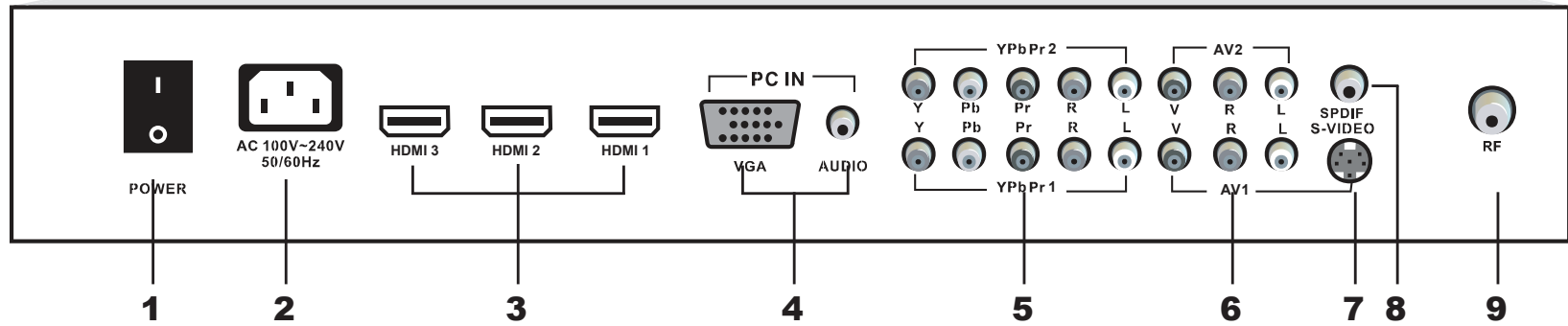

1. Master Power ON/OFF Switch - When the master power is switched OFF, the power button located on the remote control and right side of the television will not function. Make sure it is switched ON for regular TV viewing on a daily basis.

2. AC Power Plug - Insert power plug during initial setup.

3. HDMI Inputs (3) - Connects to digital AV equipment that feature HDMI connectivity. HDMI supports enhanced high definition video and two-channel digital audio all from one cable.

*Recommended for best performance

4. PC IN - VGA/Audio Input (3.5mm) - Connect an optional VGA cable from your personal computer and a 3.5mm audio cable for sound.

5. YPbPr 1/2 Inputs and R/L Audio Inputs (2) - Connect up to two (2) AV devices that feature component (YPbPr) video and audio output jacks.

6. AV 1/2 Inputs (2) - Connect up to two (2) standard AV devices to the composite VIDEO (Y) and AUDIO (L/R) output jacks found on most external video equipment.

7. S-Video - Connects to the S-Video output jack found on external video equipment. For audio, connect an AUDIO L/R cable to the L/R on AV1 adjacent to the S-Video input.

8. SPDIF - Connect an optional coaxial digital cable through a compatible amp/receiver to enjoy superior audio sound.

9. RF Input - Connect antenna or cable for television reception.

It is strongly recommended that the installation of a high quality roof top antenna, digital cable, or satellite set top box be used in conjunction with your television for best broadcast reception. For indoor use, we suggest an amplified HDTV antenna.

Roof Antenna / Cable Outlet Installation

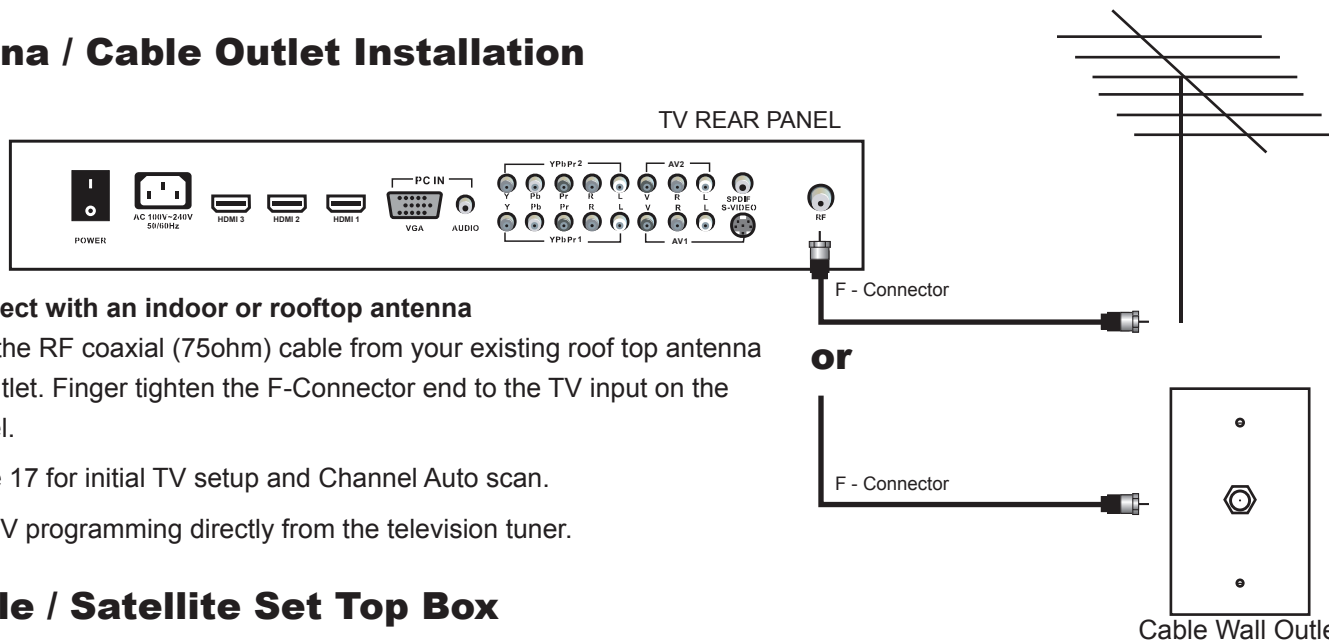

How to connect with an indoor or rooftop antenna

- Connect the RF coaxial (75ohm) cable from your existing roof top antenna or wall outlet. Finger tighten the F-Connector end to the TV input on the rear panel.
- See page 17 for initial TV setup and Channel Auto scan.
- Tune to TV programming directly from the television tuner.

Digital Cable / Satellite Set Top Box

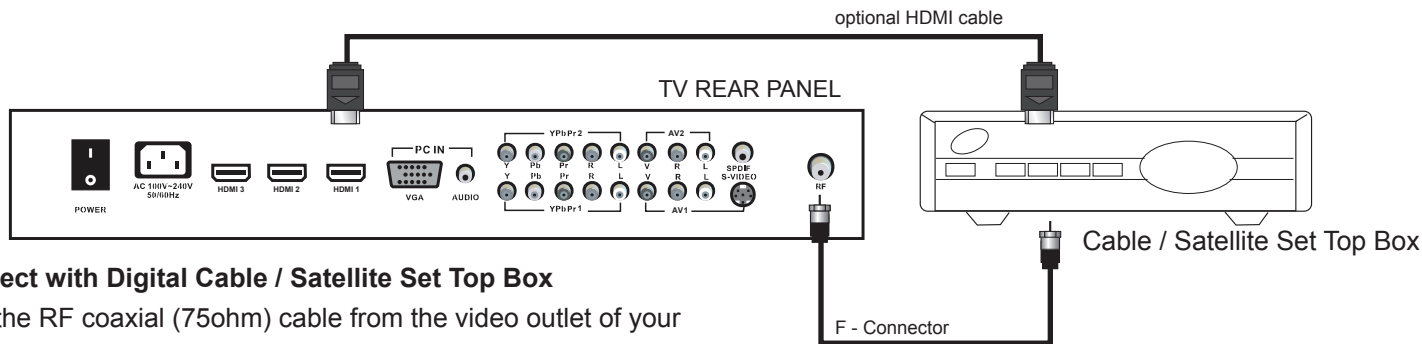

How to connect with Digital Cable / Satellite Set Top Box

- Connect the RF coaxial (75ohm) cable from the video outlet of your cable / Satellite box to the RF input on the TV's rear panel. Select Ch. 3 or 4 on the TV and select a channel.
- For better performance, use AV, component or an HDMI installation. Refer to your set top box user manual.
- See page 17 for initial TV setup and Channel Auto scan.

Connecting to an HD Set-Top Box or High Definition DVD Player Using HDMI

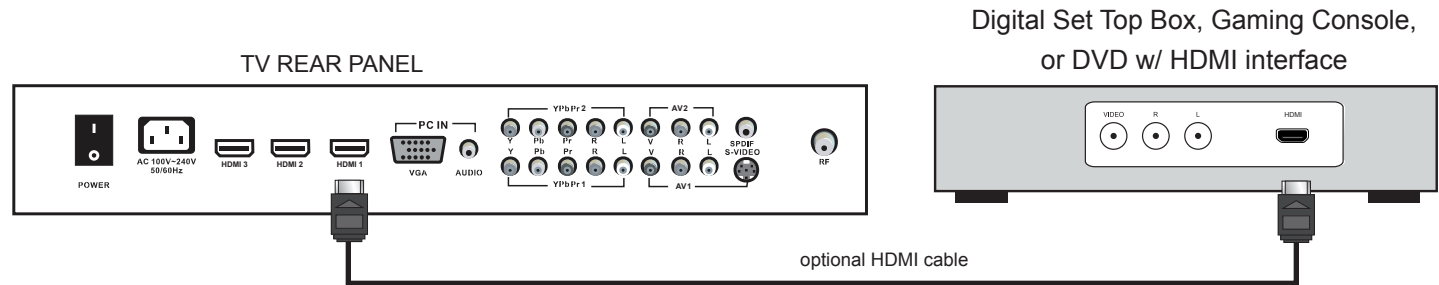

For BEST video performance

Connect to A/V equipment that offers HDMI, an uncompressed, all digital video / audio interface found on today's HD digital set top boxes and high definition DVD players. Use of this pure digital technology offers enhanced high definition video and digital audio all via a single cable.

There are three (3) HDMI inputs available for use with HD Set Top Boxes, gaming consoles and HD DVD / Blu-ray players.

How to Connect HDMI

- From your external digital A/V equipment, connect an HDMI cable from the HDMI output to the HDMI input on the TV's rear panel.

How To Use

- Press the INPUT button on the remote control. Use ▼▲ arrow buttons to highlight the input to view (HDMI 1,2,3) then press ENTER.

INPUT SOURCE
TV
AV1
AV2
S-Video
Component 1
Component 2
HDMI 1
HDMI 2
HDMI 3
VGA

Connecting A/V Equipment to Component Video IN (YPbPr1, YPbPr2) on your television

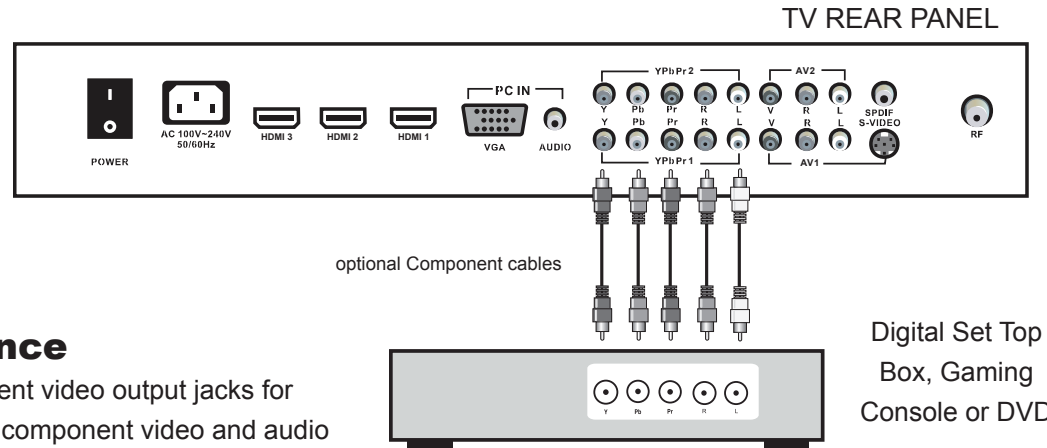

For BETTER video performance

Connect to A/V equipment that features component video output jacks for excellent performance. There are two (2) YPbPr component video and audio inputs for use with set top boxes, gaming consoles, and DVD players.

How to Connect Component

- When connecting A/V equipment to your television, match the colors of the connecting jacks (Video: Blue, Green, Red; Audio: White/Red)
- Connect optional component video cables (blue, green, red) from the video output jacks (Y, Pb, Pr) on your external A/V equipment (ie: DVD Player, set top box) to the YPbPr1 and/or YPbPr2 input(s) on the TV's rear panel.
- Connect white/red audio cables for sound from the audio (L/R) output jacks on your external A/V equipment (ie: DVD Player, set top box) to the YPbPr1 or YPbPr2 L/R input(s) on the TV's rear panel.

How to Use

- Press the INPUT button on the TV remote control. Use ▼▲ arrow buttons to highlight the input to view (Component 1,2) then press ENTER.

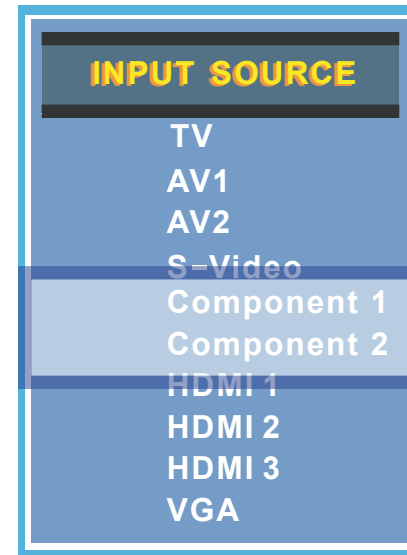

Connecting A/V Equipment to Composite or S-Video IN on your television

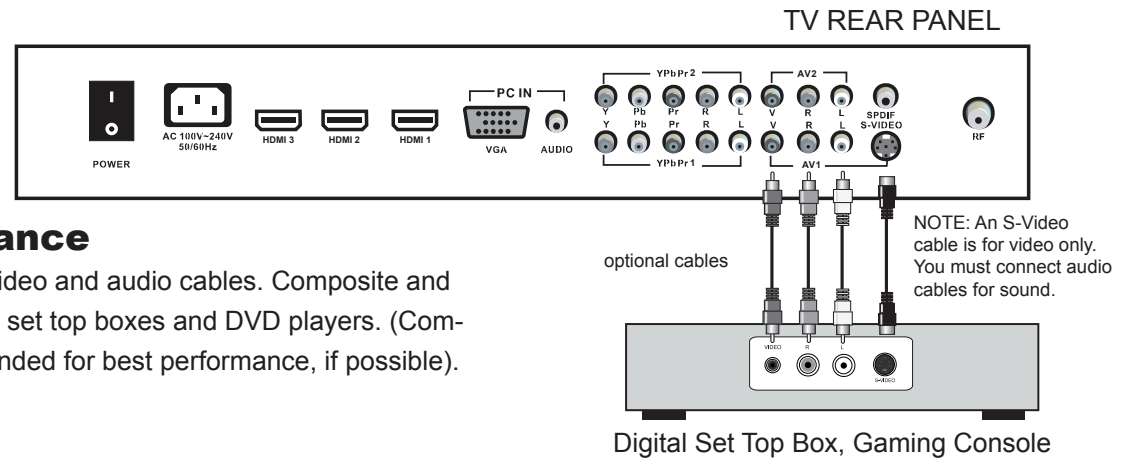

For GOOD video performance

Connect to A/V equipment using optional video and audio cables. Composite and S-Video output jacks are available on most set top boxes and DVD players. (Component or HDMI connections are recommended for best performance, if possible).

How to Connect Composite

- When connecting A/V equipment to your television, match the colors of the connecting jacks (Video: Yellow; Audio: White/Red)
- Connect the yellow video cable from the video output jack on your external A/V equipment (ie: DVD Player, set top box) to AV1 or AV2 input on the TV's rear panel.
- Connect the white/red audio cables for sound from the audio (L/R) output jacks on your external A/V equipment (ie: DVD Player, set top box) to the AV1 or AV2 (L/R) jacks on the TV's rear panel.

How to Connect S-Video

- Connect an optional S-Video cable from the S-Video output jack on your external A/V equipment to the S-Video input on the TV's rear panel.
- Connect the white/red audio cables for sound from the audio (L/R) output jacks on your external A/V equipment to the AV1 (L/R) input on the TV's rear panel.

How to Use

- Press the INPUT button on the remote control. Use ▼▲ arrow buttons to highlight the input to view (AV1, AV2, S-Video) then press ENTER.

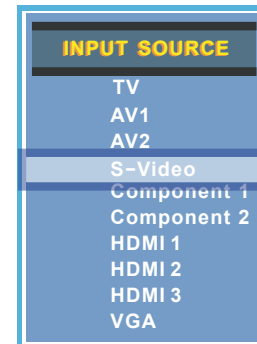
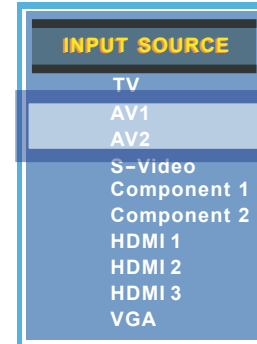

Connecting a Personal Computer with VGA to your television

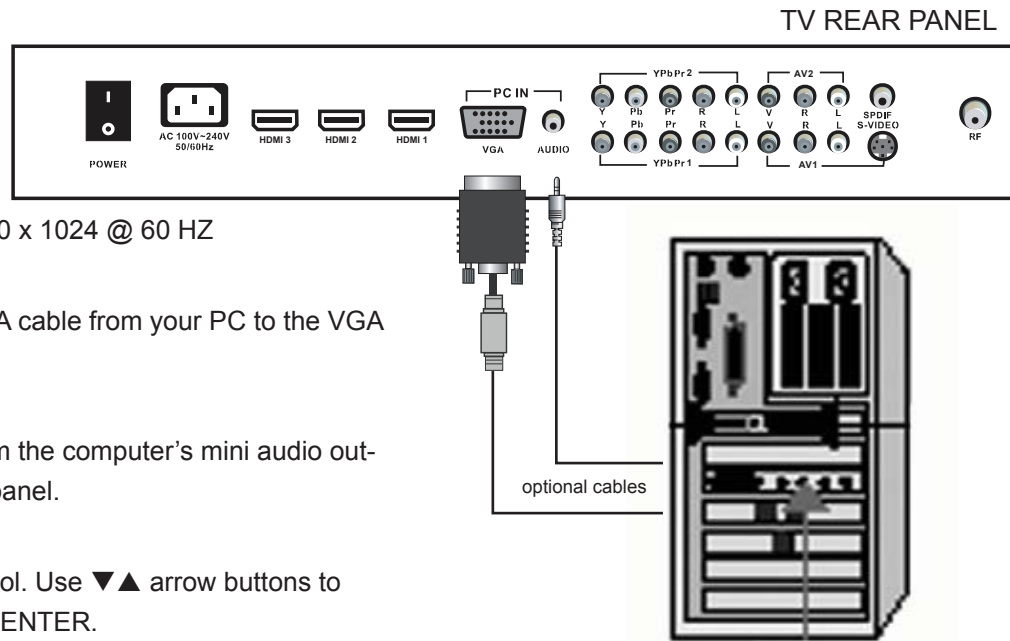

Recommended computer display resolution: 1280 x 1024 @ 60 HZ

How to Connect a PC

- Connect using an optional male to male VGA cable from your PC to the VGA input on the TV's rear panel.

How to Connect Audio sound

- Connect an optional 3.5mm audio cable from the computer's mini audio output jack to the audio input on the TV's rear panel.

How to Use

- Press the INPUT button on the remote control. Use ▼▲ arrow buttons to highlight the input to view (VGA) then press ENTER.

Display Modes

- Screen images have been optimized during manufacturing for the display modes listed below. If your PC system uses a standard signal mode, the screen will adjust automatically.

Video signal: (VGA / DVI VESA Standard).

Resolution	Vertical Freq (Hz)	Horizontal Freq (Hz)
1280 x 1024 (recommended)	60	48.4
	70	56.5
	75	60.0
	85	68.7
1152 x 864	75	67.5
1280 x 960	60	60.0
1280 x 1024	60	47.7
1366 x 768	60	48.5

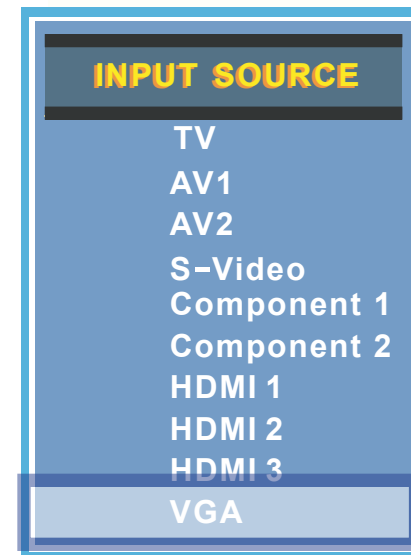

Connection to a Home Theater Audio System

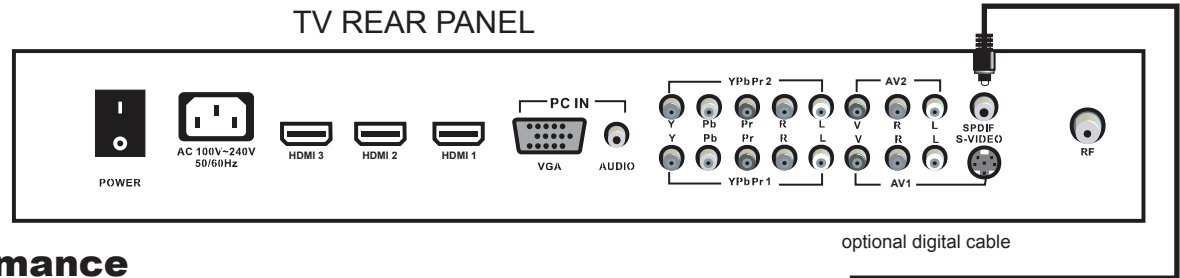

For BEST audio performance

Connecting to a Home Theater System

Dolby Digital can deliver optimal 2 channel stereo or surround sound with five discrete full range channels plus a sixth channel for a subwoofer.

Enjoy optimal sound reproduction from your system with a Dolby Digital amplifier that incorporates a digital coaxial input. Connect an optional digital cable directly to the television's SPDIF audio output to listen through all inputs except VGA. (The VGA does not support digital audio)

How To Setup Digital Output*

- Press the MENU button on the remote control.
- Press the right ► arrow button to select AUDIO.
- Press the down ▼ arrow button to highlight SPDIF type ► Raw or PCM*

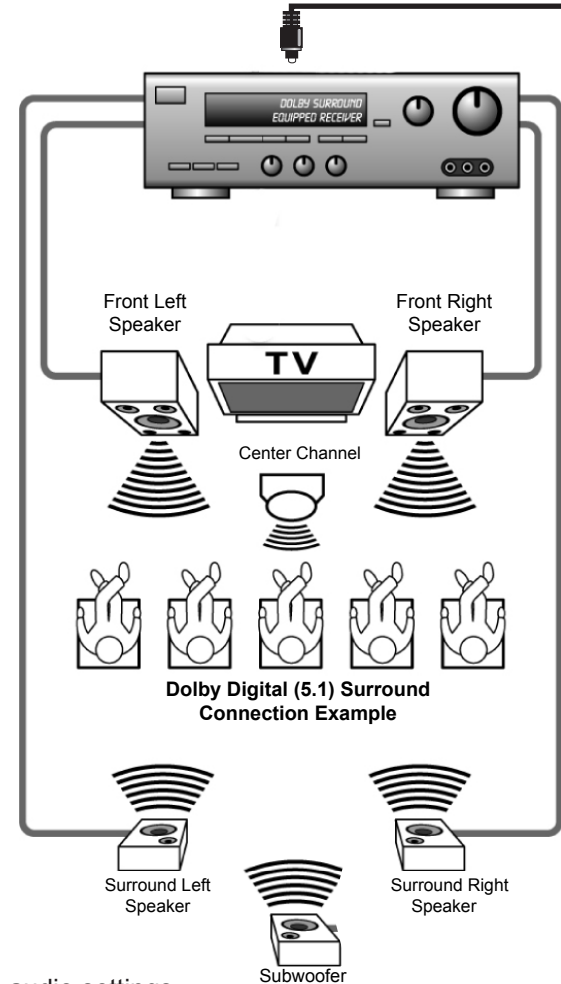

*NOTE: Refer to the User Manual from your home theater equipment for recommended audio settings.

Connecting to a Home Theater Audio System

TV REAR PANEL

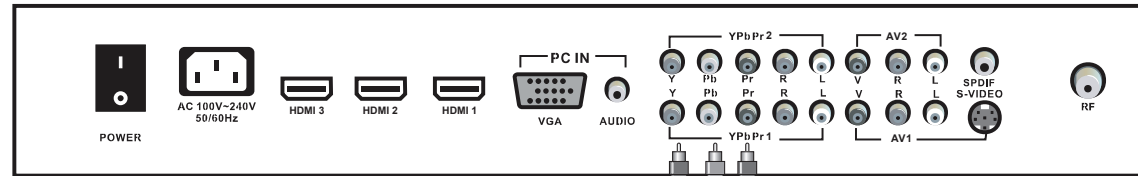

Connecting to a Stereo Receiver/Amplifier

- Enjoy realistic sound from a stereo / receiver amplifier or Dolby Pro Logic sound system when connected to your AV equipment.

Example: Diagram illustrates the connection of audio cables from your AV equipment to a stereo receiver instead of the audio (L/R) jacks on the TV's rear panel.

NOTE: When audio cables are connected to a stereo / receiver amplifier, no audio sound will be heard from the TV's built-in speakers.

How to Use (Video)

Press the appropriate INPUT button on the remote control. Use ▼▲ arrow buttons to highlight the input to view then press ENTER.

How to Use (Audio)

Select the appropriate input from your audio equipment.

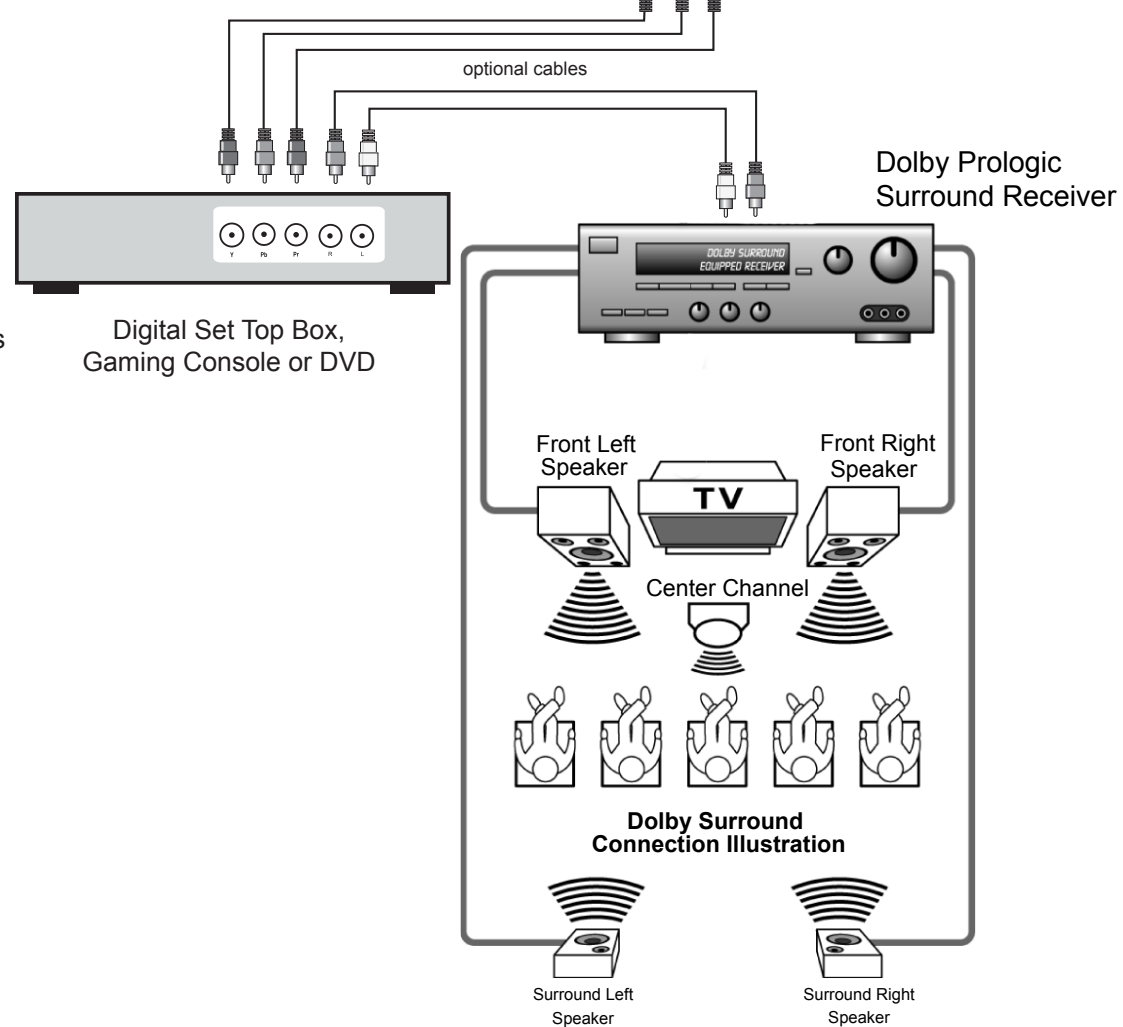

After you have initially connected your TV antenna or cable (no set top box) turn the television ON. A screen will display asking you to run a Channel Auto Scan to search and receive available local digital channels. It is here where you will select antenna options and run Channel Auto Scan. Channels will be stored in the TV tuner.

- Press the **MENU** button on the remote control.
- Using the ◀ ▶ arrow buttons, scroll to highlight **TV mode**.
- Press the down ▼ arrow button to highlight **AIR/CABLE**

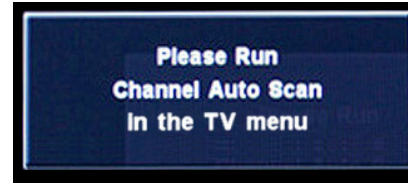

How to Navigate:

Select **AIR** when connected to an indoor/outdoor antenna.

- Press the ◀ ▶ arrow button to highlight **AIR**
- Press the down ▼ arrow button to select **Auto Scan** then press the ▶ right arrow button to start Channel Auto Scan.
- **Channel Auto Scan** may take several minutes to complete.

Air Mode



Cable Mode

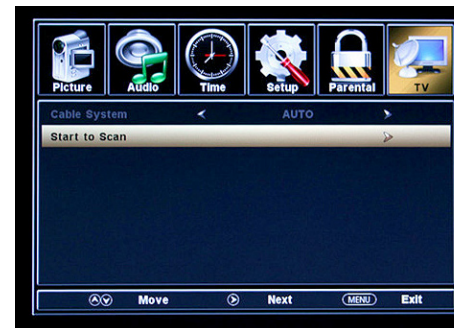

Select **CABLE** if you subscribe to a pay television service including satellite.

- Using the ◀ ▶ arrow button to highlight **CABLE**
- Press the down ▼ arrow button to select **AUTO SCAN**. Press **ENTER** and the cursor will move up and **CABLE SYSTEM** will be displayed next.
- Press the ▶ arrow button to select **STD > IRC > HRC > Auto** (Auto is recommended).
- Press the down ▼ arrow button to select **Auto Scan** and press **ENTER** to start Channel Auto Scan
- **Channel Auto Scan** may take several minutes to complete.

NOTE: For cable or satellite users with no TV antenna, there no need to run Channel Auto Scan. Connect your cable or satellite set top box to one of the available inputs on the TV for viewing.

The **PICTURE** menu offers options to enhance and refine the picture displayed on your TV based on ambient room light and personal preferences. Adjustment options include contrast, brightness, color, sharpness and color temperature.

How to Navigate:

Press the **MENU** button on the remote control. Navigate using ◀▶ arrow buttons to select **PICTURE**. Press the down ▼ arrow button to highlight **PICTURE MODE**, then press the ▶ arrow button to select your viewing preference from 4 factory options:

STANDARD > DYNAMIC > MOVIE > PERSONAL. The STANDARD setting is recommended for most viewing environments. Depending on the ambient light level in the room, you may find one of the other options more pleasing.

To make more critical adjustments based on your own preferences in PERSONAL:

- Use down ▼ arrow button to highlight **Contrast**. Navigate using the ◀▶ arrow buttons to increase or decrease contrast intensity.
- Use down ▼ arrow button to highlight **Brightness**. Navigate using the ◀▶ arrow buttons to increase or decrease overall brightness.
- Use down ▼ arrow button to highlight **Color**. Navigate using the ◀▶ arrow buttons to increase or decrease color intensity.
- Use down ▼ arrow button to highlight **Tint**. Navigate using the ◀▶ arrow buttons to adjust colors toward green or reddish tint.
- Use down ▼ arrow button to highlight **Sharpness**. Navigate using the ◀▶ arrow buttons to soften or view crisper edges in the picture.
- Use down ▼ arrow button to highlight **Color Temperature**. Navigate using the ◀▶ arrow buttons to select COOL (more bluish tone), NORMAL or WARM. The default setting is NORMAL. WARM mode will provide color that is calibrated to D6500° Kelvin, the standard color that broadcast stations and the Motion Picture industry consider as the most accurate to view programming.



Note: When adjustments are completed, you may select another menu by pressing the Menu button.

The **AUDIO** menu offers options to make sound enhancements while listening through the built-in speakers or to select digital audio options when connected to a Dolby Digital receiver through a (SPDIF) coaxial digital output.

How to Navigate:

Press the **MENU** button on the remote control. Navigate using ◀▶ arrow buttons to select **AUDIO**. Press the ▼ arrow button to highlight **SOUND MODE**, then press the ▶ arrow button to select your sound preference from 4 factory options: **PERSONAL > STANDARD > MUSIC > MOVIE**.

To make more critical sound adjustments based on your own preferences in **PERSONAL**:

- Use down ▼ arrow button to highlight **Bass**. Navigate using the ◀▶ arrow buttons to increase or decrease low frequency intensity.
- Use down ▼ arrow button to highlight **Treble**. Navigate using the ◀▶ arrow buttons to increase or decrease high frequency intensity.
- Use down ▼ arrow button to highlight **Balance**. Navigate using the ◀▶ arrow buttons to adjust sound towards the left or right speaker.
- Use down ▼ arrow button to highlight **Surround**. Press the ▶ arrow button to turn the dimensional surround effect ON or OFF. (for built-in speakers only).
- Use down ▼ arrow button to highlight **AVC**. Navigate using the ▶ arrow button. In the ON position, Automatic Volume Control will limit the level of increased volume heard during television commercials and volume differences between inputs.
- Use down ▼ arrow button to highlight **SPDIF type**. Navigate using the ◀▶ arrow buttons to select between PCM (Analog Audio) > RAW (Digital Audio). See page 15.



- Use down ▼ arrow button to highlight **Audio Language**. Navigate using the ◀▶ arrow buttons to select to listen to an alternative language broadcast (if available) English > Spanish > French.

(You may select an alternative language using the remote control by pressing **MTS**)

Note: When adjustments are completed, you may select another menu by pressing the Menu button.

The **TIME** menu includes adjustment of settings for your local time zone and daylight savings time. The clock will adjust automatically after the initial Channel Auto Scan of available broadcast channels in your area. (See page 17 for Initial TV Setup)

How to Navigate:

Press the **MENU** button on the remote control. Navigate using arrow ◀ ▶ buttons to select **TIME**.

- Use down ▼ arrow button to highlight **Time Zone**. Then press the ▶ arrow button to select between: **EASTERN > CENTRAL > MOUNTAIN > PACIFIC > ALASKA > HAWAII**
- Use down ▼ arrow button to highlight **Daylight Savings Time**. Navigate using the ◀ ▶ arrow buttons to turn this feature on or off.



Note: When adjustments are completed, you may select another menu by pressing the Menu button.

In the **SETUP** menu you may change the initial set up of preferences that include settings for language, menu display, computer monitoring, closed captions, enhancement of black detail in the picture and resetting your TV back to its factory default status.

How to Navigate:

Press the **MENU** button on the remote control. Navigate using arrow ◀▶ buttons to select **SETUP**. Gain access to display options by pressing the down ▼ arrow button to highlight **Menu Language** or other options, then press ▶ arrow button on your remote to select.

- Other languages include Spanish and French.



- Highlight **Transparency**. Navigate using the ◀▶ arrow buttons to turn Off ▶ On the translucent effect of the User menu.



- Highlight **Zoom Mode**. Navigate using the ◀▶ arrow buttons to select the viewing mode displayed: Normal > Wide > Zoom > Cinema. (This feature is also available on the remote control. See page 27)



- Highlight **Noise Reduction**. Navigate using the ◀▶ arrow buttons to reduce video noise: Off > Low > Medium > High (Default setting: Low)



- Highlight **XVS**. Navigate using the ◀▶ arrow buttons to select: Off > On. XVS provides noticeable black detail enhancement that may be preferred.



- Highlight **Restore Default**. Press the ▶ arrow button to automatically set all adjustments back to their original settings.

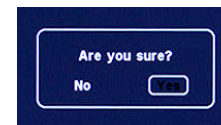

When prompted, Select "Yes" to confirm.



NOTE: Closed Caption and Advanced are features described on the following pages.

The **SETUP** menu includes adjustments for activating the **Closed Caption** feature for display on the television and customizing CC display types and font styles.

How to Navigate:

Press the **MENU** button on the remote control. Navigate using arrow ◀▶ buttons to select **SETUP**. Press the down ▼ arrow button to highlight **Closed Caption**.



- Use down ▼ arrow button to highlight **Advanced Selection**. Navigate using the ◀▶ arrow buttons to select Service 1-6.



- Use down ▼ arrow button to highlight **CC Mode**. Navigate using the ◀▶ arrow buttons select Off > On > CC on Mute



- Use down ▼ arrow button to highlight **Option**. Press the ▶ arrow button to enter a menu with options to customize text fonts, colors and opacities.



- Use down ▼ arrow button to highlight **Basic Selection**. Navigate using the ◀▶ arrow buttons select CC 1-4, Text 1-4.



Note: When adjustments are completed, you may select another menu by pressing the Menu button.

In the **SETUP** menu you may adjust the position of images displayed on screen once you connect an input signal from your **PC**. Recommended resolution is 1280 x 1024. If your PC system uses a standard signal mode, the screen will adjust automatically. Connect an optional 3.5mm audio cable for stereo sound. See page 14 for details.

How to Navigate:

After connecting to a **PC**, press the **INPUT** button and highlight **VGA**, then press ENTER. Press the **MENU** button on the remote control and navigate using arrow ◀ ▶ buttons to select **SETUP**. Gain access to position adjustment options by pressing the down ▼ arrow button to highlight **Advanced**, then press ▶ arrow button to select from the following options.



- Highlight **Clock**. Navigate using the ◀ ▶ arrow buttons to control the width of the image.



- Highlight **H-Pos**. Navigate using the ◀ ▶ arrow buttons to adjust the position of images displayed from side to side.



- Highlight **Phase**. Navigate using the ◀ ▶ arrow buttons to improve focus and image stability.



- Highlight **V-Pos**. Navigate using the ◀ ▶ arrow buttons to adjust the position of images displayed up and down.



- Highlight **Auto**. Press the ▶ arrow button to automatically adjust the display to the best setting. When prompted, select Yes to confirm.

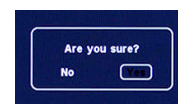

When prompted, Select "Yes" to confirm.



In the **Parental** menu, you may block television and movie programming based on TV ratings and Motion Picture Association guidelines. To gain access and select your preferences within the Parental menu make certain your input is set to TV.

How to Navigate:

Press the **MENU** button on the remote control. Navigate using arrow ◀ ▶ buttons to select **PARENTAL**. Gain access to parental rating options by pressing the down ▼ arrow button to highlight **ENTER PASSWORD**. Enter your 4 digit code (factory default code is "0000") unless previously changed.

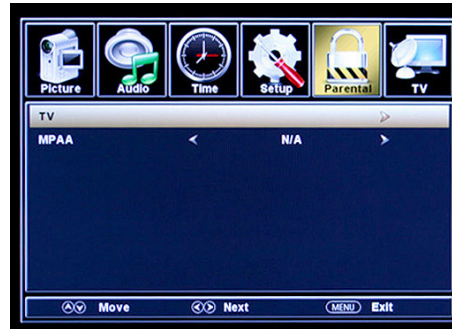

- To set parental controls for television programming or DVD movies, press the down/up ▼▲ arrow buttons to highlight **US**. Navigate using the ◀ ▶ buttons to highlight **TV/MPAA** menu.

- To change the password, press ▶ arrow button to display a screen to enter your new password, then confirm again. (Not illustrated)

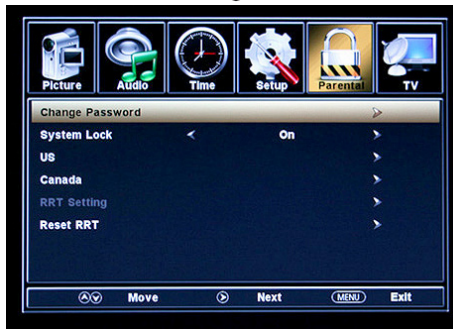

- Highlight **TV**, then press the ▶ arrow button to enter the TV Ratings menu to select your preference.

TV - Y Appropriate for all children
 TV - Y7 Appropriate for all children over 7
 TV - G General Audience
 TV - PG Parental Guidance Suggested
 TV - 14 Parents Strongly Cautioned
 TV - MA Mature Audience Only

- To make changes to **PARENTAL** controls, highlight **SYSTEM LOCK** then press the ▶ arrow button to **ON**.



- Highlight **MPAA** then press the ▶ arrow button repeatedly to select your movie rating preference.

G General Audience
 PG Parental Guidance Suggested
 PG13 Parents Strongly Cautioned
 R Restricted
 NC17 No One Under 17 Permitted
 X Adults Only

NOTE: RRT Setting and Reset RRT are not user adjustable settings.

In the **PARENTAL** menu, you may block television and movie programming based on Canadian TV and movie rating guidelines. To gain access and select your preferences within the Parental menu make certain your input is set to **TV**.

How to Navigate:

Press the **MENU** button on the remote control. Navigate using arrow ◀ ▶ buttons to select **PARENTAL**. Gain access to rating options by pressing the down ▼ arrow button to highlight **ENTER PASSWORD**.. Enter your 4 digit code (factory default code is "0000") unless previously changed. See page 24 for information on how to change your password.

- Navigate using down ▼ arrow button to highlight **CANADA ENGLISH** then press the ▶ arrow button repeatedly to select your ratings preference.

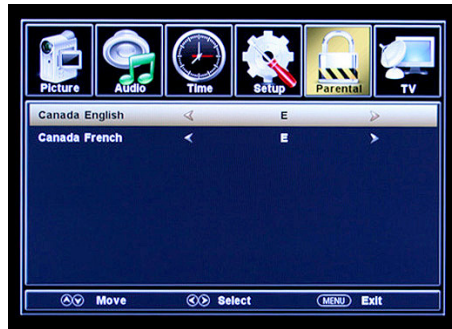

- E Appropriate for everyone
- C Appropriate for all children
- C8+ Appropriate for everyone 8 years old and up
- G General Audience
- PG Parental Guidance
- 14+ Appropriate for Children over 14 years old
- 18+ Mature Audience Only

- Navigate using down ▼ arrow button to highlight **CANADA FRENCH** then press the ▶ arrow button repeatedly to select your ratings preference.



- E Appropriate for everyone
- G General Audience
- 8 ans+ Appropriate for Children 8 years old and up
- 13 ans+ Appropriate for Children 13 years old and up
- 16 ans+ Appropriate for Children 16 years old and up
- 18 ans+ Mature Audience Only

Note: When adjustments are completed, you may select another menu by pressing the Menu button.

The **TV** menu provides for the setup of your television to receive TV channels, store your favorites, add or skip channels and label them by their call letters. (For antenna and Channel Auto Scan setup, please refer to page 17.)

How to Navigate:

Press the **MENU** button on the remote control. Navigate using arrow ◀▶ buttons to select **TV**. Press the down ▼ button to highlight your preferences.

- Highlight **FAVORITE** to add channels to your Favorites List. Navigate using the ◀▶▼▲ arrow buttons to select channels to be added or deleted from your list. Press ENTER to add or delete a channel. A checkmark indicates a channel has been added. You may also display your **FAVORITE** list from the remote control by pressing **FAV**.

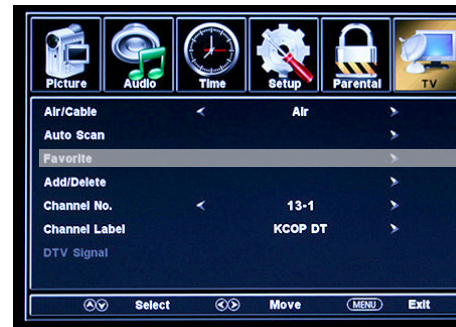

- Highlight **ADD/DELETE** to select or skip channels already in memory. Navigate using the ◀▶▼▲ arrow buttons to access the list of available channels. Press ENTER to change the channels status. A checkmark indicates a channel has been added.



- Highlight **CHANNEL LABEL** to name or rename a broadcast channel. Navigate using the ▶ arrow button to enter the screen menu to re-label a channel. Use the ▼▲ arrow buttons to spell out each letter, number or character. Use ◀▶ arrow buttons to advance to the next space.



NOTE: The **DTV SIGNAL** is a measurement of signal strength for the current channel viewed.

The **ZOOM** function offers several viewing display options on the 16:9 screen. Press ZOOM to cycle through the following widescreen settings.

Press ZOOM to cycle through the following widescreen settings.



1. NORMAL

Recommended for viewing native widescreen content and undistorted 4:3 images. (With Black Bars)



2. WIDE

Stretches certain 4:3 content and may reduce the black bars.



3. ZOOM

Stretches the image both vertically and horizontally to fill the screen when viewing widescreen content. The zoom effect will crop images somewhat.



4. CINEMA

When viewing 4:3 content, Cinema mode will fill the entire screen eliminating the side black bars. It may also eliminate or reduce black bars on certain widescreen movies.



Display Technology	LCD TV
Sizes (inches)	32" Class (31.5" Diagonal)
Apect Ratio	16:9
Panel Type	TV Panel, A grade
Resolution	1366 x 768
Digital Compatibility (YPbPr)	480i / 480p / 720p / 1080i / 1080p
Brightness (cd/ m)	450
Contrast	1500:1
Vertical Viewing Angle (degrees)	176
Horizontal Viewing Angle (degrees)	176
Maximum Colors (millions)	16.7M
Reponse Time (ms)	7ms
Audio Power	2 X 7W
Dimension w/ Pedestal Installed	31" (L) x 23.1" (H) x 4" (D) Pedestal 19.8" x 9"
Weight	28 lbs (approx.)
Input Connections	Composite Video / Audio (2) S-Video (1) YPbPr / Audio (L/R) (2) HDMI (3) RF (1) SPDIF Coaxial Digital Output (1) PC/VGA (1) PC Audio IN (1)

NOTE:
Specifications subject to change without notice.

Check for a possible solution to a symptom before contacting a customer service representative.

Symptom	Possible Solutions
Cannot receive certain channels through the antenna	<ul style="list-style-type: none"> • Use the Channel Auto Scan function to add the channels not included in memory. See page 17. • Readjust your antenna and retry Channel Auto Scan. • Signal from the TV station may be weak in your area.
No color	<ul style="list-style-type: none"> • Check the video installation of your external A/V equipment See pages 11-14
Video noise or choppy picture	<ul style="list-style-type: none"> • Readjust antenna. Keep TV away from noise sources, neon lights, and microwave appliances.
TV blocked on certain channels	<ul style="list-style-type: none"> • Use the automatic scanning method to add the channels not included into the memory. See page 17. • Check whether channel was deleted. See page 26. • Check parental control settings. See pages 24, 25.
Cannot use certain functions	<ul style="list-style-type: none"> • If the item chosen in a menu is shown in gray text, that item cannot be selected in the current input.
No sound	<ul style="list-style-type: none"> • Check that connected audio cables are completely inserted • Verify you have selected the correct audio source from your amplifier. See page 15, 16. • Mute function maybe enabled, press mute on the remote.
Black box on screen	<ul style="list-style-type: none"> • The "Text" option is enabled and no text is available. Turn off CC in the Setup menu under Closed Caption, pg.22
No power	<ul style="list-style-type: none"> • Batteries in the remote control may need replacing. • Re-attach AC plug to wall outlet • Check that the Master Power switch is ON. See page 9.
No picture	<ul style="list-style-type: none"> • Digital TV channel signal maybe weak, try another channel • Press input button repeatedly to select connected A/V equipment. • Re-connect the antenna or cable wiring.
Remote control does not function	<ul style="list-style-type: none"> • Replace batteries with new ones • Check that battery polarity is correct • Point remote directly at the TV (See pg. 6)

A		Display	7	Picture Modes	7, 18
AC power plug	9	Display Modes for PC	14	Power	7-9
Add/Delete channels	26	E		R	
Advanced mode	23	Exit	7	RAW	15
Advanced selection	22	F		Ratings (TV, Movie)	24-25
Air/Cable	10, 17	Favorite Channels	7, 26	Recall	7
Antenna installation	10	G		Remote Control	6-7
Arrow buttons	7	Guide	7	RF Input	9, 10
Audio setup & adj.	7, 14-16, 19	H		Restore Default setting	21
Audio Language	19	HDMI Input	11	Reset Password	24
AVC (Audio volume control)	19	Home theater	15, 16	Roof Antenna	10
B		I		S	
Balance adjustment	19	IR Receiver	6, 8	Satellite installation	10-13
Bass adjustment	19	Input	7-8, 11-14	Sleep timer	7
Batteries	6, 29	L		S-Video Input	9, 13
Brightness adjustment	18	Languages	19, 21	Sharpness adjustment	18
C		LED light	8	SPDIF Type	9, 15, 19
CCD (Closed Caption)	7, 22	M		Standby	7-8
Cable installation	10, 17	Master Power	8-9	Speakers (built-in)	16, 19
Canadian Ratings	25	Menu	7-8, 17-26	Surround Sound	15-16, 19
Channel Up/Down	7-8	MTS	7, 19	T	
Channel Auto Scan	17	Mute	7	Time Zone	20
Channel Label	26	Movie Ratings	24-25	Tint adjustment	18
Channel List	7	Movie mode	18	Treble adjustment	19
Clock	20, 23	N		Transparency	21
Cinema Zoom	27	Normal Zoom	27	V	
Coaxial Digital Output	15	Noise Reduction	21	Video adjustment	18
Color adjustment	18	Number buttons	7	Volume adjustment	7-8
Color Temperature	18	P		VGA installation & adj.	9, 14, 23
Composite Input	13	Parental Control	24-25	W	
Component Input	12	Password	24-25	Wide Zoom	27
Computer connection	14, 23	Pedestal stand removal	9	XYZ	
Contrast adjustment	18	PC	9, 14, 23	XVS (Black detail enhancement)	21
D		PCM	15	YPbPr	9, 12
Dash (-)	7	Phase	23	Zoom Modes	7, 21, 27
Daylight Savings Time	20				
Default settings	21				
Digital Cable	10				
Digital set top box	10				
Digital audio	15				
Dolby Digital	15, 16				

Limited North American Warranty Apex Digital Inc. LD3249

Apex Digital, Inc. expresses the following limited warranty. This warranty extends to new APEX LD3249 purchased from an authorized Apex U.S. reseller/retailer and used within the U.S. by the original purchaser or consumer received the new product as a gift and no other purchaser or transferee. You must retain the original bill of sale for proof of purchase.

Limited One (1) Year Warranty

Apex Digital warrants the parts in this product against defects in material or workmanship for a period of one (1) year from the date of original purchase. During this period, Apex Digital will replace a defective part with a new or refurbished part without charge to you. It is the responsibility of the consumer to retain original packaging or provide like packaging in order to facilitate the warranty process. Apex Digital, Inc. will incur no liability whatsoever to provide packaging for warranty items. Upon receipt of the warranty item, should it be determined that the packaging was insufficient, Apex Digital Inc., at its discretion, may void the warranty. The consumer is responsible for the transportation (cost) and insurance charges (if applicable) for the set to the Service Center or Apex Digital. The consumer will be responsible for all tariffs, duty and taxes imposed to ship or receive warranty or warranty replacement units to and from the U.S. You must receive a return authorization number before sending a unit in for service.

Limited Ninety (90) Days Labor Warranty

Apex Digital warrants it will be responsible for labor charges for repair or replacement of parts on this product for a period of ninety days from the date of original retail purchase. During this period, Apex Digital will repair or replace a defective part at its sole option, with a new or refurbished part or product without charge to you, except for the shipping charges incurred by the consumer, if any, to the Service Center.

Your Responsibility

The above warranties are subject to the following conditions: You must retain the original bill of sales to provide proof of purchase. There are no exceptions. You must call the provided phone number for an assessment of the problem. No service or shipment of product will be accepted unless an RMA# is provided, attached or printed to shipping carton along with bill of sale. You are responsible for all tariffs and taxes imposed to ship or receive warranty or warranty replacement units to and from the U.S. These warranties are effective only if product is purchased through an Authorized retail reseller and the unit is operated in North America. Labor service charges for set installation, setup, adjustment of consumer controls and installation or repair of any type of antenna or cable systems are not covered by this warranty. Reception problems caused by inadequate antenna or cable systems are your responsibility. Warranties extend only to defects in materials or workmanship as limited above and do not extend to any other products or parts that have been lost, discarded or damaged by misuse, accident, neglect, acts of God, such as lightning or voltage surges in the home, improper installation, improper maintenance or use in violation of instructions provided or product which has been modified, have had the serial number removed, altered, or rendered illegible. Warranties do not cover cosmetic damage or lost accessories.

How to Obtain Warranty Service

If after following the operating instructions, the Troubleshooting Guide and the FAQ pages on televisions, found at our website, www.apexdigitalinc.com. 1. Should it be necessary to contact Customer Service Center directly, call (866) 427-3946 Daily 8am to 6pm (Pacific Time). You will be instructed on how your claim will be processed. 2. Have your pertinent information available including proof of purchase and an understanding of the complaint.

Limitations

Your LCD panel is an innovative device that is manufactured to precise tolerances with active performing pixels of at least 99.99%. As such, it is NOT a malfunction to view multiple non-performing pixels on your screen. All warranties implied by state law are expressly limited to the duration of the limited warranties set forth above with the exception of warranties implied by state law as hereby limited, the foregoing warranty is exclusive and in lieu of all other warranties, guarantees, agreements etc., with respect to repair or replacement of any parts. Apex Digital shall not be liable for consequential or incidental damage. The warranty gives you specific rights and you may also have these rights that may vary from state to state. Some states do not allow limitation on how long a warranty lasts, or the exclusions or limitation of incidental or consequential damages, so the above may not apply to you.

Free Manuals Download Website

<http://myh66.com>

<http://usermanuals.us>

<http://www.somanuals.com>

<http://www.4manuals.cc>

<http://www.manual-lib.com>

<http://www.404manual.com>

<http://www.luxmanual.com>

<http://aubethermostatmanual.com>

Golf course search by state

<http://golfingnear.com>

Email search by domain

<http://emailbydomain.com>

Auto manuals search

<http://auto.somanuals.com>

TV manuals search

<http://tv.somanuals.com>