

Please Read and Save this Use and Care Book

LITTERMAID *Elite*TM

ADVANCED AUTOMATIC Self-Cleaning Litter Box

with

Ionic
Air Cleaner



USA/Canada 1-800-LITMAID

1 (800) 548-6243

www.littermaid.com

Accessories/Parts (USA/Canada)

1-800-738-0245

Models
LME5500
LME9000
LME9250

WELCOME TO THE FAMILY!

Congratulations on your purchase of the LitterMaid Elite™ Advanced Automatic Self-Cleaning Litter Box. This product is designed to make caring for your cat a simpler, less time-consuming process.

OPERATING INSTRUCTIONS FOR THE LITTERMAID® SELF-CLEANING LITTER BOX

- Cat enters the unit; once he/she leaves, the sensors are triggered, setting the timer for the cleaning cycle. (Sensors need to be blocked for at least 5 seconds.)

Important: Unit will not start a cleaning cycle while cat is in the box.

- As soon as the cat leaves the litter box, the sensor activates the 10-minute countdown and the ionic air cleaner.
- The ionic air cleaner stays on during the countdown and the cleaning cycle.
- After the 10-minute countdown, the cleaning cycle starts and the rake scoops out the waste clumps.
- If the cat re-enters and leaves the litter box before the initial 10 minutes have elapsed, the timer will automatically reset and delay the beginning of the cleaning cycle for an additional 10 minutes.

Note: Rake stops and reverses if the safety bar touches any object that has gotten behind the rake while it is returning to its home position.

- Rake opens waste receptacle compartment cover and deposits clumps into the waste receptacle.

Note: Rake stops and reverses if it encounters an obstacle larger than 35 lb. It will try five times to clear the obstacle. If obstacle is not cleared the rake reverses back to the home position and the green POWER LED blinks (1 time per second).

- Sealed disposable waste receptacle allows for safe and easy disposal of waste when full.
- If the sleep timer is activated, the rake will not cycle for 9 hours from the set sleep mode time (the ionic air cleaner will automatically turn on every hour for 10 minutes).

Important: When the ON/OFF button is in the OFF position it only disables the rake function.

IMPORTANT SAFEGUARDS

Instructions pertaining to a risk of fire, electric shock or injury to persons.

WARNING: When using electric appliances, basic precautions should always be followed including the following:

- Read all the instructions before using the appliance.
- To reduce the risk of injury, close supervision is necessary when an appliance is used near children.
- Do not contact moving parts.
- Only use attachments recommended or sold by the manufacturer.
- Do not use outdoors.
- To reduce the risk of electric shock, do not put LitterMaid Elite™ Advanced Automatic Self-Cleaning Litter Box in water or other liquid. Do not place or store appliance where it can fall or be pulled into a tub or sink.
- NOT INTENDED FOR USE WITH KITTENS UNDER SIX MONTHS.**
- Not intended for use by handicapped, incapacitated or very old cats that might experience difficulty in entering or leaving the litter box.
- PREGNANT WOMEN and IMMUNE-DEFICIENT PEOPLE** should avoid contact with cat waste at all times.
- CAUTION: THIS IS NOT A TOY.** The LitterMaid Elite™ Advanced Automatic Self-Cleaning Litter Box is a precision-operated appliance. Should the rake become jammed during cleaning, **THIS UNIT CONTAINS A MECHANISM THAT WILL AUTOMATICALLY STOP, REVERSE AND RESTART THE CLEANING OPERATION.**
- For cat use only. The LitterMaid Elite™ Advanced Automatic Self-Cleaning Litter Box is intended solely for the safe elimination of cat waste. **DO NOT ATTEMPT TO USE THIS PRODUCT FOR ANY OTHER PURPOSE.**
- Never allow small children to play in or around this device.
- Please read all directions in this manual carefully prior to operating this product.

**Intended for Household Use Only.
SAVE THESE INSTRUCTIONS.**

Product may vary slightly from what is illustrated.

Accessories

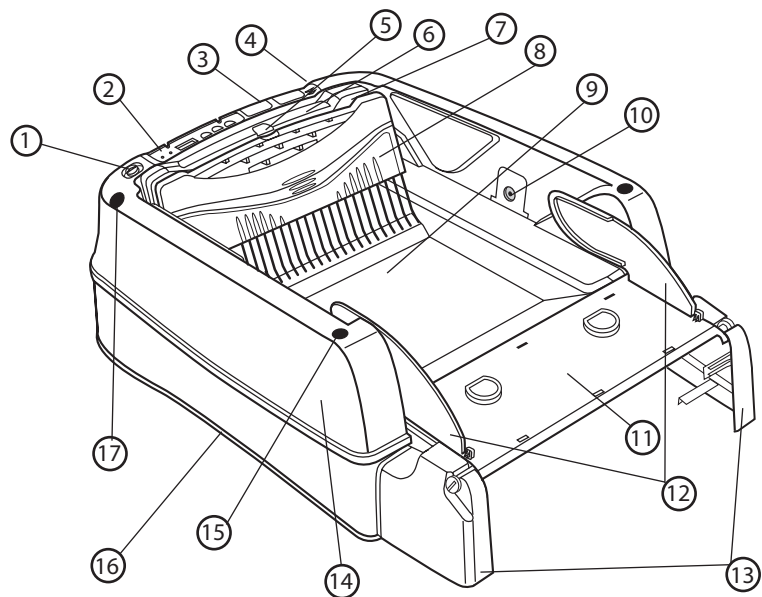

1. ON/OFF/SLEEP switch
Important: When the ON/OFF button is in the Off position it only disables the rake function.
 2. Control panel
 3. Warranty board
 - † 4. Battery compartment cover (Part# 7688-9080W) (batteries not included)
 5. Green LED ionizer light (some models)
 6. Ionic air cleaner (some models)
 7. Motor housing
 - † 8. Rake (Part# LME5500W-02)
 - † 9. Litter tray (Part# 7686-8050W, LME5500), (Part# 7686-2050W, LME9000)
 10. Sensors (both sides)
 - † 11. Waste receptacle compartment cover (Part# LME9000W-02)
 12. Flaps
 - † 13. Receptacle supports
Right (Part# 7001-2050W) and Left (Part# 7001-1050W)
 14. Top housing
 15. Plug holes for Plug 2 (1 each side)
 16. Cutout handle (1 each side)
 17. Plug holes for Plug 1 (1 each side)
- † Consumer replaceable/removable parts

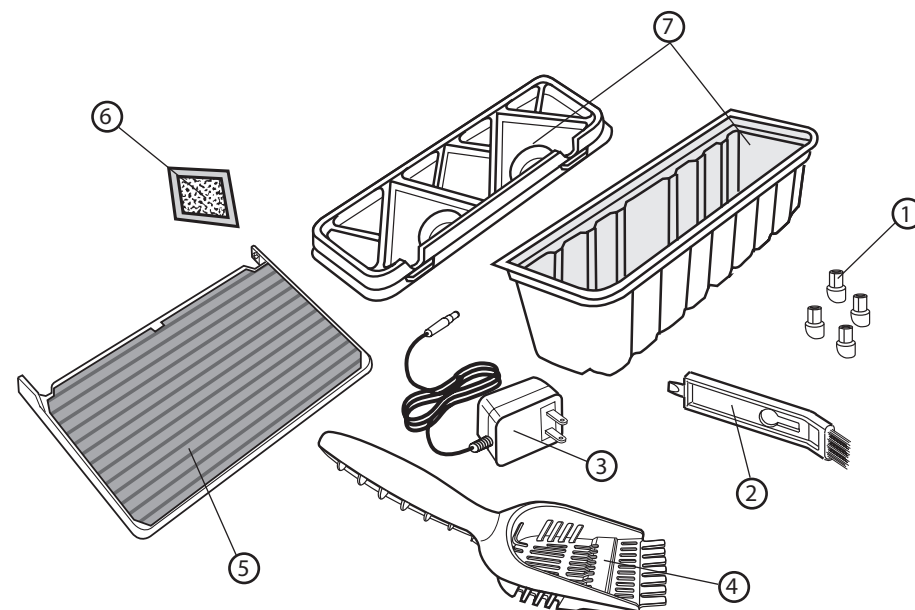

- † 1. Tent plugs (4) set (Part# LME9000W-01)
 - † 2. Cleaning brush (Part# 5125-0074W)
 - † 3. AC adapter (Part# 4101-1022W)
 - † 4. LitterMaid® triple-action tool (Part# 7003-5050W)
 - † 5. Ramp (Part# 5506-3146W) (some models)
 - † 6. Carbon Filters (12 pk) (Part# LMF200) (some models)
 - † 7. Disposable waste receptacle
(12 pk.) (Part# LMR200)
(18 pk.) (Part# LMR300)
- † Consumer replaceable/removable parts

Control Panel

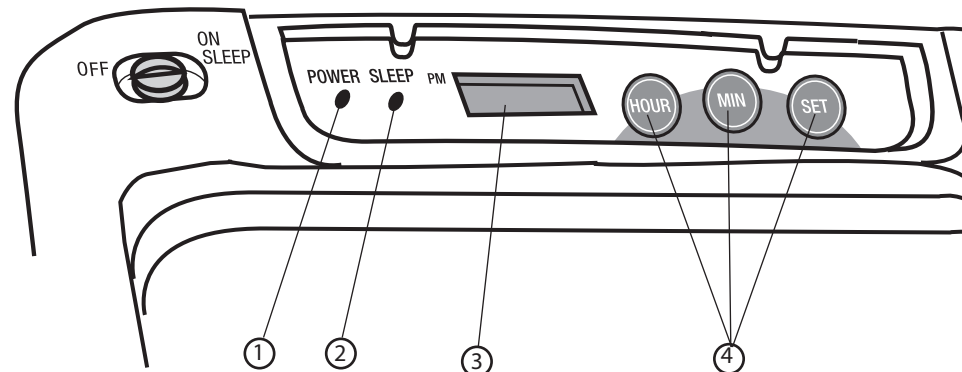

1. Green LED POWER indicator light
2. Red LED SLEEP indicator light
3. Digital clock
4. Time/Programming buttons

Accessories

Check our online service for parts and accessories at www.littermaid.com or call 1-800-548-6243

	Model #
LitterMaid Kitty Kabana™ litter box cover	LMT200
LitterMaid Elite™ litter box cover	LMT250
LitterMaid® litter box carpet	LMC100
LitterMaid® premium clumping cat litter	LML100
Disposable waste receptacles (12 pk.)	LMR200
Disposable waste receptacles (18 pk.)	LMR300
Carbon filters (12 pk.)	LMF200

Setup Instructions

No Tools Required for Setup

- Unpack the pieces of the unit listed below.
- Peel off the protective tape on the battery compartment.
- Cut or remove the tie restraints on the underside of unit.

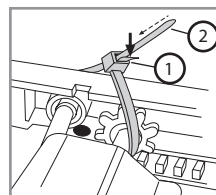

1. Press down
2. Slide through

Before getting started be sure you have all of the following contents:

Litter tray	1
Top housing	1
Waste receptacle compartment supports	2
Waste receptacle compartment cover	1
Rake	1
AC adapter (in styrofoam)	1
Disposable waste receptacles	amount varies
Carbon filters	(certain models)
LitterMaid® triple-action tool	1
Use and care manual	1
Kabana Plugs	4
Cleaning brush (packed with disposable waste receptacles)	1
Quick Start Sheet	1
Optional items:	
Paw-cleaning ramp	1
LitterMaid Kitty Kabana™ Litter Box Cover.	

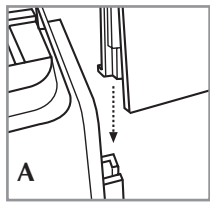

Assembly

1. Slide receptacle supports (marked L (left) and R (right)) into grooves on the bottom tray until they lock into place (A).

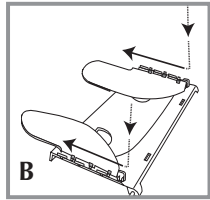

2. Place both left and right flaps flat on top of the waste receptacle compartment panel.
3. Push the flaps in and up until they click into place (B).

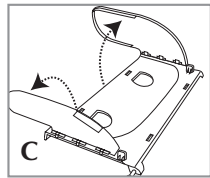

4. Lift the flaps until they lock into place (C).

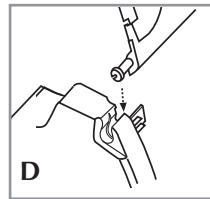

5. Snap each pivot of the waste receptacle compartment cover, one at a time, into notches in the receptacle supports (D).
6. Open waste receptacle compartment cover.

Important: Waste receptacle compartment cover must be opened to remove and install top housing.

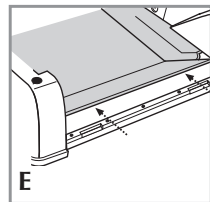

7. Lift top housing. Angle into position bracket-end of top housing under tray ledge. **Important: The tray should be on top of the white bar in front of the top housing (E).** Bring the other end of top housing down into place. Check to be sure top housing is positioned securely on the tray.

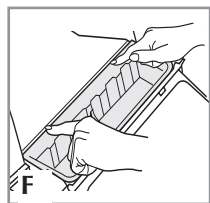

8. **Insert waste receptacle:**
 - Open waste receptacle compartment cover.
 - Insert a disposable waste receptacle into the waste receptacle compartment.
 - Insert the edge of the waste receptacle in an inclined position and place it between the edge of the tray and the bar of the top housing (F).

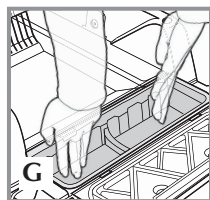

- Press the waste receptacle down into position (G).
- There should be no gap between the unit and the waste receptacle.

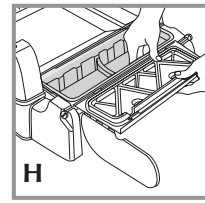

- Attach the waste receptacle lid by inserting the push tabs into the round holes. To secure, press on positions indicated (H).

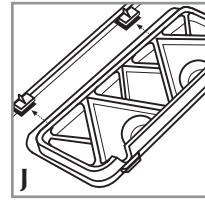

Make sure lid edges are under the cover tabs (J).

9. Install carbon filter:

- Peel off the paper strip on the carbon filter to expose the adhesive.

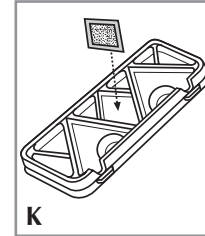

- Place filter adhesive-side down in the diamond-shaped insert in the center of the waste receptacle lid (K). Close the waste receptacle compartment cover.

10. Fill the LitterMaid® litter box to just below the Full Line marked on the inside of litter tray.

IMPORTANT: Use only premium clumping litter. Do not use non-clumping litter, crystal or pearl-like litters.

Recommended Hard Clumping Litters

- LitterMaid® Hard Clumping Cat Litter
- World's Best Cat Litter™
- ARM & HAMMER® Super Scoop® The Baking Soda Clumping Litter
- Fresh Step® Scoopable Premium Cat Litter
- EVER CLEAN® Premium Clumping Litter

Do not overfill the unit or it will not operate properly.

- Use the Fill Line on the LitterMaid® triple-action tool to check that the litter is at the correct level in the center of the unit (L).

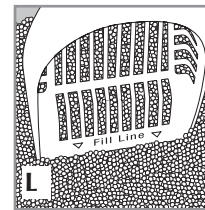

The LitterMaid® Triple-Action Tool

This handy 3-way tool helps you measure:

- Level of litter (M).

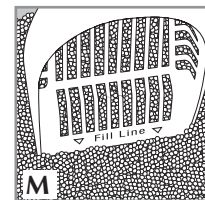

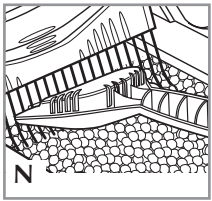

- Assists in cleaning the rake (N).

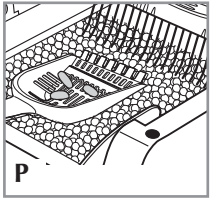

- Aids in the removal of small waste particles (P).
11. **Install paw cleaning ramp: (Certain models)**
- The paw-cleaning ramp has two pivot pins that fit into holes on the sides of the waste receptacle compartment cover.
 - Position the paw-cleaning ramp with carpet-side facing up.

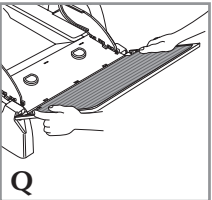

- Insert the pivot pins into the holes (Q).
- Tug slightly on the ramp to ensure that it is firmly in place.

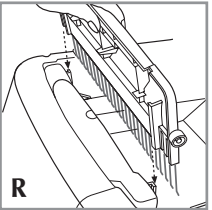

12. **Install rake:**
- Align tracks on back of rake (each end) and slide into grooves on motor housing (R).

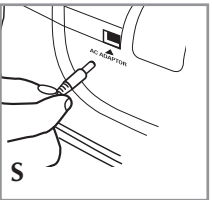

13. Remove the AC adapter from where it is packed in the styrofoam and plug it into the unit (S).
- Plug the cord into a standard electrical wall outlet.
 - Turn the ON/OFF switch to ON. The rake will automatically run through its first cleaning cycle and smooth out the litter.

Important: When the ON/OFF button is in the OFF position it only disables the rake function.

14. If the LitterMaid® Kitty Kabana™ litter box cover is not being used, place the 4 tent plugs into the 4 holes on top housing.

Note: Always use both hands to move LitterMaid® litter box by holding handle cutouts located on each side of the tray.

Setting the Clock:

1. Set the clock to the time of day by pressing the HOUR then MINUTE button.

Note: If setting P.M., be sure light in the upper left corner of the display is lit. The LED continues to blink 12:00 until the clock is set.

Programming the Sleep Timer:

Sleep mode deactivates the cleaning cycle for a period of 9 hours. During this time the ionic air cleaner automatically turns on for 10 minutes every hour to freshen the air.

After 9 hours the unit will perform one litter raking cycle and then resume normal operation. The 9-hour sleep mode and the 15-hour normal operation repeat at set time every 24 hours.

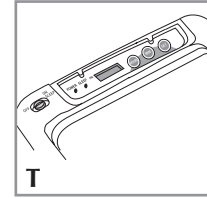

To Program the Sleep Mode Timer (T):

1. Set the clock to the time of day by pressing the hour then minute button.

Note: If setting P.M., be sure light in the upper left corner of the display is lit. The LED continues to blink 12:00 until the clock is set.

2. Press the SET button on the control panel to begin programming.
3. Sleep mode red LED starts blinking.
4. Press the HOUR and MINUTE button (light indicating P.M. is in the upper left corner of the LED display) to set the time you want the sleep mode to begin (for example, if you set the time for 10:00P.M. the unit remains in the sleep mode until 7:00A.M. (9 hours)).
5. Sleep mode time is automatically accepted if no buttons are pressed for 3 seconds or more.
6. Sleep mode red LED stops blinking and red LED is not lit.
7. Sleep mode is now set, but not activated.

To Activate Sleep Mode:

1. Press and hold the set button.
2. Steady red light comes on to indicate that the sleep mode is activated.

To Deactivate Sleep Mode:

1. Sleep mode must be activated (red LED lit) to be deactivated.
2. Press the SET button, steady red LED is no longer lit.

Ionic Air Cleaner:

- As soon as the cat leaves the litter box, the sensor activates the 10-minute countdown and the ionic air cleaner.
- The ionic air cleaner stays on during the countdown and the cleaning cycle.
- If the sleep timer is activated the rake will not cycle for 9 hours from the set sleep mode time (the ionic air cleaner will automatically turn on every hour for 10 minutes).

Optional Items:

For more information: call, 1-800-738-0245; or visit our website, www.littermaid.com.

Litter Box Carpet:

- Place the assembled unit on the carpet.

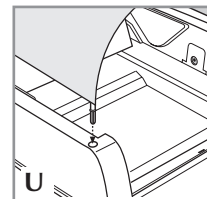

LitterMaid Kitty Kabana™ litter box cover:

- Assemble to cover unit (U). (See instruction sheet.)

Helpful Information:

If you need to acclimate your cat to the LitterMaid® Advanced Automatic Self-Cleaning litter box, refer to ACCLIMATING YOUR CAT in this use and care book.

Unit will work without setting the clock when unit is turned on.

If your unit is not working properly, refer to TROUBLESHOOTING in this use and care book.

Batteries (we recommend using batteries only as a back-up):

- Push up on center ridges to open battery compartment door.
- Remove the battery door.
- Follow the diagram in the compartment to install 8, AA Alkaline cell batteries. (Batteries not included.)

Just as your alarm clock continues to run on batteries if there is a power failure, the LitterMaid® litter box will continue to operate as long as batteries are installed. Change the batteries periodically.

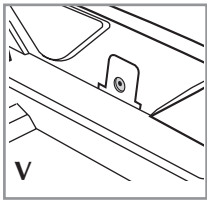

Sensors:

Sensors (located on interior side panels) must be kept clean. Wipe sensors with a soft, dry cloth to keep them dust free (V).

LED operation, function and why they blink:

Green on control panel	Power LED indicator is lit when power to the unit is on.
Blinking green on control panel	LED blinks (2 times per second) indicating batteries are low. LED blinks (1 time per second) when the rake assembly has encountered a blockage.
Green on ionizer	Ionic air cleaner LED (behind the rake) is only lit when the ionizer is operating.
Red on control panel	Sleep timer LED is continually lit when sleep mode is activated.
Blinking red on control panel	Occurs during the sleep mode programming.

ACCLIMATING YOUR CAT

If your cat needs to acclimate to the new LitterMaid® Advanced Automatic Self-Cleaning litter box, follow these instructions:

- Place the LitterMaid® unit next to your old litter box.
- Set it to run automatically by turning the ON/OFF switch to ON.

Important: When the ON/OFF button is in the Off position it only disables the rake function.

- Do not clean out the old litter box. (Cats prefer to use a clean box, and the LitterMaid® litter box will always be clean.)
- If your cat is shy, do not operate the LitterMaid® litter box automatically for 2 to 3 days. (Turn the ON/OFF switch to OFF)
- Manually activate the LitterMaid® litter box 2 to 3 times a day for the first 2 to 3 days, to let your cat get used to going into the LitterMaid® litter box before you set it to clean automatically.
- As soon as your cat is acclimated to the LitterMaid® litter box, set it to clean automatically. Turn ON/OFF switch to ON, and remove the old litter box.

Note: Do not place your LitterMaid® litter box in a wet environment or in direct sunlight. Do not use outdoors or on patios.

Care and Cleaning

Sensor Covers

The two sensors located on the interior side panels are protected by sensor covers that need to be kept dust free. After changing or adding litter, wipe each sensor with a soft, dry cloth to remove dust.

Litter Tray

Use only premium clumping litter. Lesser quality litters will impair performance.

To empty and clean litter tray:

- Check to make sure rake is in home position.
- Turn the switch to the OFF position.

Important: When the ON/OFF button is in the Off position it only disables the rake function.

- Unplug unit and remove batteries to prevent accidental activation of the unit.
- Remove the waste receptacle.
- Remove the rake.
- Remove the top housing.
- Dispose of the used litter. To ensure proper disposal of litter, follow manufacturer's instructions on litter package. Wipe the litter tray with a damp cloth. If further cleaning is necessary, the litter tray can be fully immersed in water and washed with a mild detergent.

Important: Do not soak or immerse the top housing in water. To clean, wipe with damp cloth. Dry the unit completely before reassembling.

- Before reassembling, spray litter tray surface with nonstick cooking spray or silicone spray, and wipe with a soft, dry cloth. This will help to prevent waste clumps from adhering to the surface of the tray.

Removing Disposable Waste Receptacle

We recommend avoiding contact with waste material. Wear rubber or latex gloves when handling used disposable waste receptacle.

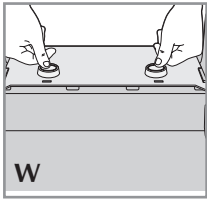

- Depress the two push tabs in the waste receptacle compartment cover (**W**). (Detach the disposable waste receptacle lid from the waste receptacle compartment cover.)
- Lift the compartment cover, exposing the closed disposable waste receptacle assembly.

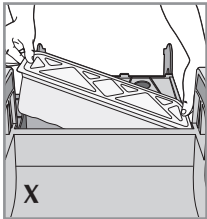

- Press in on all four corners of lid to secure lid to the waste receptacle, pull the disposable waste receptacle edge free from the tabs holding it in place, lift out and dispose (**X**).

Disposable waste receptacles are available in packages of 12 or 18 and may be purchased through your local retailer, by visiting our website at www.littermaid.com, or by calling us at 1-800-738-0245. We will be happy to assist you in any way we can.

Rake Removal & Cleaning

Removing the rake:

The rake can be removed for easy cleaning.

We recommend wearing rubber or latex gloves when handling the soiled rake.

- Be sure rake is in the home position.
- Grasp rake ledge underneath logo and slide up and off of unit.
- Clean rake with a soft cloth using warm water and mild detergent. Do not use scouring pads or harsh or abrasive chemicals. Spray rake lightly with nonstick cooking spray or a silicone spray before reinstalling.

Note: Rake may be cleaned while installed by using the LitterMaid® triple-action tool.

Paw-Cleaning Ramp: (Optional item)

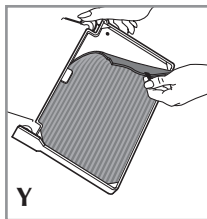

- Remove mat by gently pulling on the fabric strip provided (**Y**).
- The mat is held in place by 5 tabs and will remove easily.
- Remove and clean carpet by using a vacuum cleaner.
- To return it to its original position, reinsert carpet under the tabs. It is not necessary to remove the plastic ramp to clean the mat.

Note: For small stains, moisten a sponge with mild detergent and cold water; wipe to clean. Do not use soaps or chemical cleaners, as they may be harmful to your cat.

Caution: Do not place carpet in washer or dryer. Do not vacuum carpet when it is wet.

Troubleshooting

Rake continues to go through cleaning cycles.

Probable Cause:

- Too much litter in the litter box is causing excess litter to collect **behind** the rake, preventing it from returning to home position. Or, there is an obstacle in **front** at the rake. If the rake cannot move an obstacle during the cleaning cycle, the unit will go through a cleaning cycle up to five times in an attempt to clear the obstacle. If unsuccessful, the rake will return to its home position, and the green light will blink slowly (1 time per second), indicating that the rake has encountered an obstacle it cannot move.

Solution:

1. Turn the ON/OFF switch to OFF.

Important: When the ON/OFF button is in the OFF position it only disables the rake function.

2. Clear the obstacle.

Be sure litter in tray is just below the Full Line. Use the LitterMaid® triple-action tool to measure the level of the litter in the center of the unit. Full Line will not be visible if tray is overfilled.

3. Turn the ON/OFF switch to ON.

4. The rake will run through a complete cleaning cycle. When cycle is finished, the unit is ready for use.

Unit does not operate 10 minutes after cat leaves.

Probable Cause:

- Dusty sensors (Sensors need to be covered for 5 seconds to activate.)

Solution:

1. Wipe each sensor with a soft, dry cloth.

2. Turn the ON/OFF switch to OFF.

Important: When the ON/OFF button is in the OFF position it only disables the rake function.

3. Turn the ON/OFF switch to ON.

4. Unit will run through a cleaning cycle.

Unit does not completely clean litter box.

Probable Cause:

- Low-quality clumping litter.

Solution:

1. Do not use non-clumping, crystal or pearl-like litter.
2. Use only premium clumping litter.

Unit does not operate when ON/OFF switch is switched on.

Important: When the ON/OFF button is in the OFF position it only disables the rake function.

Probable Cause:

- Power outage
- Faulty or non-activated outlet
- Old batteries

Solution:

- Check batteries and outlet
- Use batteries in case of power outage
- Switch to battery power

Probable Cause:

- Incorrectly installed or dead batteries. (Batteries should only be used as backup.) Change the batteries once yearly.

Solution:

1. Turn ON/OFF switch to OFF.
2. Open battery compartment; check to see that batteries are correctly installed.
3. Turn ON/OFF switch to ON. The unit should perform a whole cleaning cycle.
4. If unit does not operate, replace batteries with fresh ones and try again.

5. If unit does not operate with fresh batteries, try it with the AC adapter.

6. Green light should come on. If it does not, there is a problem with the AC adapter or batteries.

Probable Cause:

- AC adapter does not work

Solution:

Turn ON/OFF switch to OFF and check the following:

1. The AC adapter plug is inserted fully into the input jack.
2. The power outlet is operating. (You may wish to double-check by plugging unit into another outlet.)
3. Wait a few seconds and turn unit on again. Green light should come on and the unit should perform a complete cleaning cycle.
4. If unit still does not operate, turn ON/OFF switch to OFF and unplug the AC adapter.
5. Operate the unit on battery power only.

Waste clumps adhere to the surface of the litter tray.

Probable Cause:

- Soiled litter tray surface (We recommend wearing rubber or latex gloves when handling waste.)

Solution:

1. Remove clumps with scoop and dump litter into another container.
2. Remove litter tray (refer to CARE AND CLEANING in this use and care book), clean with mild detergent, rinse and dry.
3. Spray litter tray surface with nonstick cooking spray or silicone spray, and wipe with a soft, dry cloth. This will help to prevent waste clumps from adhering to the surface of the tray.

Power light fails to come on when ON/OFF switch is turned ON.

Important: When the ON/OFF button is in the OFF position it only disables the rake function.

Probable Cause:

- **Power outage or batteries are incorrectly installed or dead.**

Solution:

1. Turn ON/OFF switch to OFF then back to ON.
2. Make sure there is power to the unit and/or fresh batteries are correctly installed.

If you can't solve the problem using this Troubleshooting section, more help is available by calling Customer Service at 1-800-LIT-MAID (548-6243).

Power light blinks slowly and continuously.

Probable Cause:

- Rake has encountered an obstacle it cannot remove. If the rake cannot move an obstacle during the cleaning cycle, the unit will go through a cleaning cycle up to five times in an attempt to clear the obstacle. If unsuccessful, the rake will return to its home position, and the green light will blink slowly (approximately once every second), indicating that the rake has encountered an obstacle it cannot move.

Solution:

1. Turn the ON/OFF switch to OFF.

Important: When the ON/OFF button is in the OFF position it only disables the rake function.

2. Use the LitterMaid® triple-action tool to remove the obstacle.
3. Make sure that the rake teeth are clean and free of litter. Use the LitterMaid® tool to clean rake teeth.
4. Turn ON/OFF switch to ON.

Power light blinks quickly.

Probable Cause:

- Batteries need replacing.

Solution:

Light will continue to blink until batteries are removed or until they are completely dead.

If SLEEP timer light is off:

Solution:

1. Check to be sure clock is set to the correct time.

2. Check to see if the sleep mode is set and activated, see PROGRAMMING THE SLEEP TIMER section.

If the rake is stuck in the center or dumping position:

Solution:

1. Turn the ON/OFF switch to the OFF position.

Important: When the ON/OFF button is in the OFF position it only disables the rake function.

2. Unplug unit.
3. Remove batteries.
4. Clean unit (check track for litter).
5. Wipe sensors.
6. Put unit together and plug into AC power only and turn ON/OFF switch to the ON position for the automatic cycle.

If green ionize LED is off:

Solution:

- Ionizer only turns on during 10 minute countdown and raking cycle.
- Ionizer only turns 10 minute every hour during sleep mode.

If the Rake stops in the dump position:

Solution:

1. Press ON/OFF button OFF.
2. Examine the Home position switch for obstruction (litter) preventing the switch lever arm from releasing.
3. Carefully remove the obstruction using tooth pick or dental instrument .
4. Press ON/OFF button turn unit ON.

The rake should automatically return to the Home position.

If not, more help is available by calling Customer Service at 1-800-LIT-MAID (548-6243).

NOTES

NOTES

NEED HELP?

For service, repair or any questions regarding your appliance, call the appropriate 800 number on the cover of this book. Do not return the product to the place of purchase. Do not mail the product back to the manufacturer nor bring it to a service center. You may also want to consult the website listed on the cover of this manual.

One-Year Limited Warranty

(Applies only in the United States and Canada)

What does it cover?

- Any defect in material or workmanship; provided; however, Applica's liability will not exceed the purchase price of the product

For how long?

- One year after the date of original purchase

What will we do to help you?

- Provide you with a reasonably similar replacement product that is either new or factory refurbished

How do you get service?

- Save your receipt as proof of the date of sale.
- Check our on-line service site at www.prodprotect.com/applica, or call our toll-free number, 1-800-548-6243, for general warranty service.
- If you need parts or accessories, please call 1-800-738-0245.

What does your warranty not cover?

- Damage from commercial use
- Damage from misuse, abuse or neglect
- Products that have been modified in any way
- Products used or serviced outside the country of purchase
- Glass parts and other accessory items that are packed with the unit
- Shipping and handling costs associated with the replacement of the unit
- Consequential or incidental damages (Please note, however, that some states do not allow the exclusion or limitation of consequential or incidental damages, so this limitation may not apply to you.)

How does state law relate to this warranty?

- This warranty gives you specific legal rights, and you may also have other rights that vary from state to state or province to province.



Copyright © 2008 Applica Consumer Products, Inc.

Made in People's Republic of China
Printed in People's Republic of China

R12006/10-18-56E

WIN

Free Manuals Download Website

<http://myh66.com>

<http://usermanuals.us>

<http://www.somanuals.com>

<http://www.4manuals.cc>

<http://www.manual-lib.com>

<http://www.404manual.com>

<http://www.luxmanual.com>

<http://aubethermostatmanual.com>

Golf course search by state

<http://golfingnear.com>

Email search by domain

<http://emailbydomain.com>

Auto manuals search

<http://auto.somanuals.com>

TV manuals search

<http://tv.somanuals.com>