

Arcam A85, P85 and P85/3 amplifiers
Amplificateurs Arcam A85, P85 et P85/3
Arcam-Verstärker A85, P85 und P85/3

English

Français

Deutsch



Safety guidelines

Safety instructions

This product is designed and manufactured to meet strict quality and safety standards. However, you should be aware of the following installation and operation precautions:

1. Take heed of warnings and instructions

You should read all the safety and operating instructions before operating this appliance. Retain this handbook for future reference and adhere to all warnings in the handbook or on the appliance.

2. Water and moisture

The presence of electricity near water can be dangerous. Do not use the appliance near water – for example next to a bathtub, washbowl, kitchen sink, in a wet basement or near a swimming pool, etc.

3. Object or liquid entry

Take care that objects do not fall and liquids are not spilled into the enclosure through any openings. Liquid filled objects such as vases should not be placed on the equipment.

4. Ventilation

Do not place the equipment on a bed, sofa, rug or similar soft surface, or in an enclosed bookcase or cabinet, since ventilation may be impeded. We recommend a minimum distance of 50mm (2 inches) around the sides and top of the appliance to provide adequate ventilation.

5. Heat

Locate the appliance away from naked flames or heat producing equipment such as radiators, stoves or other appliances (including other amplifiers) that produce heat.

6. Climate

The appliance has been designed for use in moderate climates.

7. Racks and stands

Only use a rack or stand that is recommended for use with audio equipment. If the equipment is on a portable rack it should be moved with great care, to avoid overturning the combination.

8. Cleaning

Unplug the unit from the mains supply before cleaning.

The case should normally only require a wipe with a soft, damp, lint-free cloth. Do not use paint thinners or other chemical solvents for cleaning.

We do not advise the use of furniture cleaning sprays or polishes as they can cause indelible white marks if the unit is subsequently wiped with a damp cloth.

9. Power sources

Only connect the appliance to a power supply of the type described in the operating instructions or as marked on the appliance.

10. Power-cord protection

Power supply cords should be routed so that they are not likely to be walked on or pinched by items placed upon or against them, paying particular attention to cords and plugs, and the point where they exit from the appliance.

11. Grounding

Ensure that the grounding means of the appliance is not defeated.

12. Power lines

Locate any outdoor antenna/aerial away from power lines.

13. Non-use periods

If the unit has a standby function, a small amount of current will continue to flow into the equipment in this mode. Unplug the power cord of the appliance from the outlet if left unused for a long period of time.

14. Abnormal smell

If an abnormal smell or smoke is detected from the appliance, turn the power off immediately and unplug the unit from the wall outlet. Contact your dealer immediately.

15. Servicing

You should not attempt to service the appliance beyond that described in this handbook. All other servicing should be referred to qualified service personnel.

16. Damage requiring service

The appliance should be serviced by qualified service personnel when:

- A. the power-supply cord or the plug has been damaged, or
- B. objects have fallen, or liquid has spilled into the appliance, or
- C. the appliance has been exposed to rain, or
- D. the appliance does not appear to operate normally or exhibits a marked change in performance, or
- E. the appliance has been dropped or the enclosure damaged.

Safety compliance

This product has been designed to meet the EN60065 international electrical safety standard.

Using this handbook

This handbook has been designed to give you all the information you need to install, connect, set up and use the Arcam A85 integrated amplifier or the P85 power amplifier. The A85 amplifier is described first, then the P85. The CR-389 remote control handset supplied with the A85 integrated amplifier is also described.

Your amplifier(s) may have been installed and set up by an authorised Arcam dealer. In this case, you may wish to go directly to the sections describing the use of this equipment.

Safety

Safety guidelines are set out on the inside front cover of this handbook.

Many of these items are common sense precautions, but for your own safety, and to ensure that you do not damage the unit, we strongly recommend that you read them.

Contents

Safety guidelines	2
Safety instructions	2
Safety compliance	2
Using this handbook	3
Safety	3
Installation: A85 integrated amplifier	4
Positioning the unit	4
Connecting to loudspeakers	4
Connecting to a power supply	5
Connecting to other equipment	5
Using your A85 integrated amplifier	6
Front panel controls	6
Recording	7
Setting up your A85 integrated amplifier	8
Using the remote control	9
CR-389 remote control	9
Installation: P85 power amplifier	10
Connecting to power, loudspeakers and other equipment	10
Remote switching	10
Three channel option	10
Using your P85 power amplifier	11
Bi-wiring and bi-amping loudspeakers	12
Before you start	12
Bi-wiring your loudspeakers	12
Bi-amping your system	12
Service information	13
Technical specification	13
Guarantee	14
On-line registration	14

Installation: A85 integrated amplifier

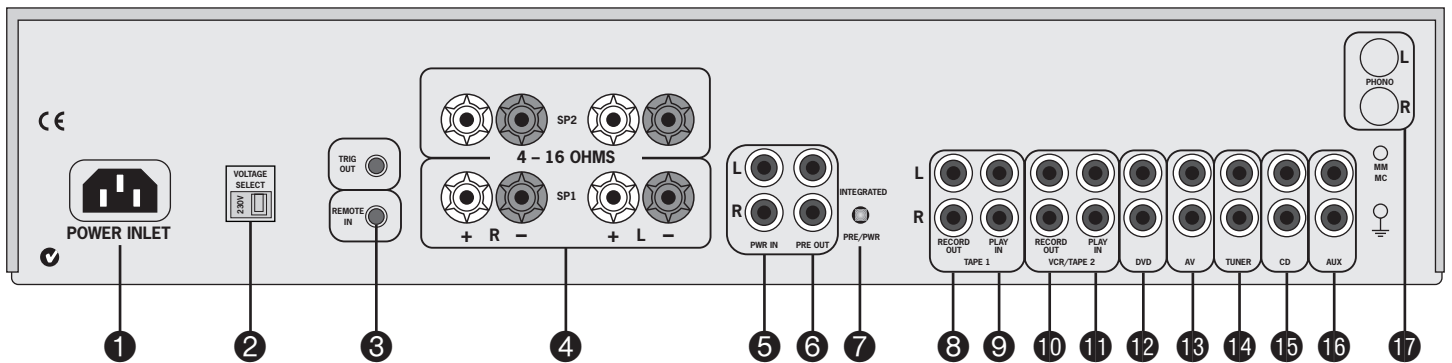

Positioning the unit

Place your amplifier on a level, firm surface.

Avoid placing the unit in direct sunlight or near sources of heat or damp.

Ensure adequate ventilation. Do not place the unit in an enclosed space such as a bookcase or cabinet as both of these will impede air flow through the ventilation slots.

Connecting to loudspeakers

You can connect one or two pairs of loudspeakers to your amplifier, provided each pair is rated between 8–16Ω. If one or both pairs have an impedance of less than 8Ω, the combined load on the amplifier falls below 4Ω and could cause an overload. If so, the overload protection circuit engages and the amplifier will not work.

To connect one pair of loudspeakers, use the **SP1** terminals.

SP1 and SP2 terminals ④

Both sets of loudspeaker terminals can be switched off by pressing the **MUTE** button on the remote control. To switch **SP1** and **SP2** independently, use the front panel switch ⑦ (see page 6) or the remote control (see page 9).

Your amplifier is fitted with loudspeaker terminals to BFA (British Federation of Audio) standard specification.

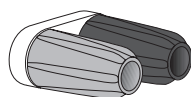

BFA loudspeaker terminals

The terminal will accept spade terminals, bare wires or a BFA plug. BFA plugs are available from your Arcam dealer. To connect a bare wire or spade terminal, unscrew the red (or black) part of the loudspeaker terminal first.

Insert the wire or spade terminal and screw it back up.

CAUTION: Do not over tighten the loudspeaker terminals or use a wrench, pliers, etc., as this could cause damage to the terminals which will not be covered under warranty.

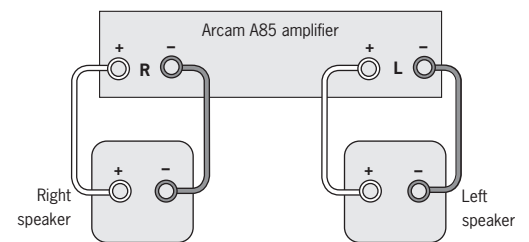

Wiring your loudspeakers

Connect the right speaker to the terminals on the back of your amplifier marked **R** and the left speaker to the terminals marked **L**.

Connect your loudspeakers so that the red (positive/+) terminal on each loudspeaker is connected to the red (positive/+) terminal on the amplifier. Your loudspeaker cables may be marked to show polarity (negative/- and positive/+), if not, then the positive terminal can usually be identified by a ridge or coloured marking.

Now connect your loudspeakers' black (negative/-) terminals to the black (negative/-) terminals on the amplifier.

Ensure that no stray strands of inner wires are allowed to touch another cable or the amplifier's casing. This can cause a short circuit and damage your amplifier!

Connecting to a power supply

Wrong plug?

Check that the plug supplied with the unit fits your supply and that your mains supply voltage agrees with the voltage setting (115V or 230V) indicated on the rear panel of the unit ② before plugging in.

If your mains supply voltage or mains plug is different, consult your Arcam dealer or Arcam Customer Support on +44 (0)1223 203203.

The product must be earthed.

Mains lead

The appliance is normally supplied with a moulded mains plug already fitted to the lead. If for any reason the plug needs to be removed, it must be disposed of immediately and securely, as it is a potential shock hazard when inserted into the mains socket. Should you require a new mains lead, contact your Arcam dealer.

Plugging in

Push the plug (IEC line socket) of the power cable supplied with the unit into the socket (**POWER INLET**) ① in the back of the unit. Make sure it is pushed in firmly.

Put the plug on the other end of the cable into your power supply socket and switch the socket on.

Standby power

For remote standby operation, the amplifier's control power supply is kept powered up all the time the unit is connected to the mains supply. The front panel power switch powers down all other circuitry. Power consumption in this mode is less than 2W.

This means that even though the power switch is off, it may be possible to hear a slight residual hum coming from the mains transformer inside the amplifier. This is perfectly normal. If the unit is to be left unused for an extended period, we recommend that it is disconnected from the mains supply by switching it off at the wall socket.

Connecting to other equipment

The use of high quality interconnect cables to and from your amplifier is recommended to ensure the best sound quality. Sockets marked **L** (and **R**) on your amplifier should only be connected to sockets marked **L** (and **R**) on other equipment. All the line inputs have the same sensitivity and may be used with equipment other than that labelled, if needed.

TAPE1/RECORD OUT ⑧ – Connect these output sockets to the input sockets of your cassette deck (usually labelled **RECORD**).

TAPE1/PLAY IN ⑨ – Connect these input sockets to the output sockets of your cassette deck (usually labelled **PLAY**). If you do not have a cassette deck you can use this input for other (line level) equipment, such as a CD player, tuner, VCR, etc., but not a turntable.

VCR/TAPE2 RECORD OUT ⑩ – These output sockets can be connected to the input sockets of VCR/second recorder (usually labelled **RECORD**).

VCR/TAPE2 PLAY IN ⑪ – Connect these input sockets to the output sockets of your VCR/second recorder (usually labelled **PLAY**). Alternatively, you can use this input for other (line level) equipment such as a CD player, tuner, etc., but not a turntable.

DVD ⑫ – Connect this input to the audio outputs of a DVD player.

AV ⑬ – Connect this input to audiovisual equipment such as a VCR, laserdisc player, satellite or Nicam tuner.

TUNER ⑭ – Connect this input to the audio outputs of your radio tuner.

CD ⑮ – Connect this input to the audio outputs of your CD player or DAC (digital to analogue converter).

AUX ⑯ – Connect this input to the audio outputs of any unit with a line level output, e.g. tape deck, tuner etc.

NOTE: The AUX inputs must not be used if the phono module is fitted. When this is fitted AUX becomes an output carrying the equalised phono signal at line level.

PHONO ⑰ – As standard, phono inputs are blanked. Phono inputs are provided on a separate plug-in module which your Arcam dealer or distributor can supply and fit. This module is compatible with most high output moving coil and moving magnet cartridges (MM) and low output moving coil cartridges (MC). MM or MC is selected via the **MM/MC** back panel switch.

Phono earth terminal – For connecting your turntable earth lead (if fitted). Note that this terminal must not be used as a safety earth.

TRIG OUT and REMOTE IN ⑳ (12V in and out) – These connections are for use in multi-room installations. In normal use there is no need to make any connections to these sockets. If you are bi-amping with a power amplifier and wish to power both units on or off simultaneously, see page 11.

Pre/power amplifier connections

PWR IN ① – To use your integrated amplifier as a power amplifier, connect the output of your pre-amplifier to the **PWR IN** sockets.

Press in the **PRE/PWR** switch ⑦ on the rear panel to select separate pre-amp/power amp mode. Under these circumstances your A85 has exactly the same specification and performance as a power amplifier (see page 8).

PRE OUT ② – To use your integrated amplifier as a pre-amplifier, connect the **PRE OUT** sockets to the input sockets of your power amplifier. With a power amplifier of the correct gain (e.g. the P85 power amplifier) you can bi-amplify ('bi-amp') suitable loudspeakers, giving significant improvements in sound quality (see page 12).

Using your A85 integrated amplifier

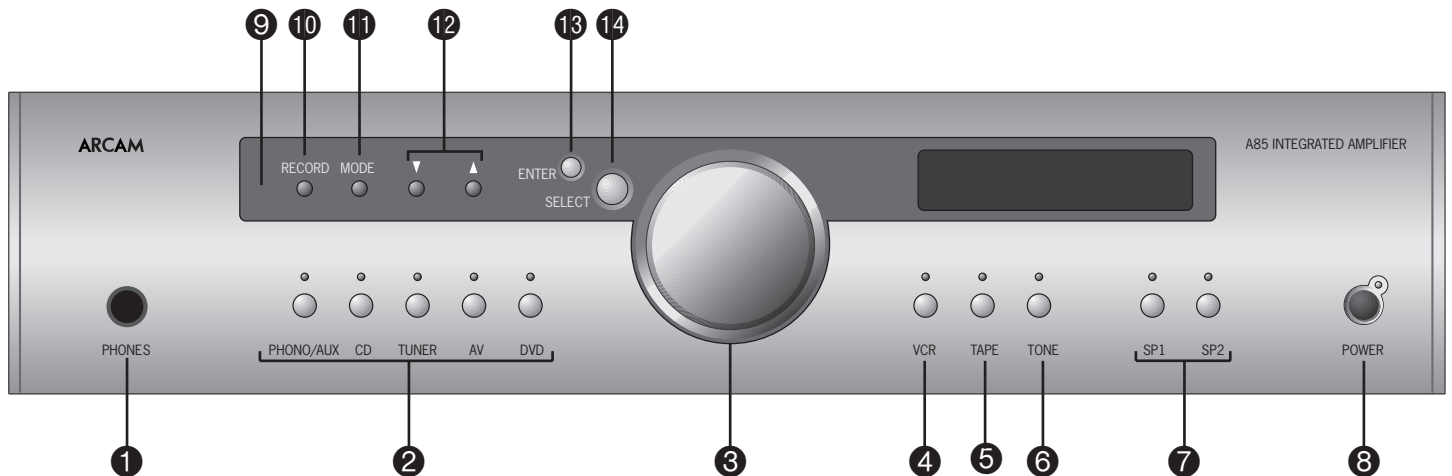

Front panel controls

This section describes how to operate your amplifier.

If your amplifier has not been installed for you, you should first read the section 'Installation: A85' on page 4.

POWER (and power indicator light) 8

Switches the unit on and off. (You can also switch the amplifier into standby mode with the remote control handset.)

The light indicates the status of the amplifier. A red light means the amplifier is in standby mode (press the **Power/Standby** button on the remote control, or the **POWER** button on the front panel, to switch between standby and powered-up modes).

When you switch your amplifier on, the light glows amber for a few seconds, during which time the speakers are disconnected. The light changes to green when the amplifier is ready for use.

The light may flash if a fault has occurred – the fault type is shown on the display. You should unplug the amplifier and leave it for a few minutes before reconnecting. If the fault cannot be cleared, unplug your amplifier and contact your Arcam dealer.

Source selectors 2

These buttons select the source connected to the corresponding input. A light above the relevant button indicates which input is currently selected and it will also usually be shown on the display.

VCR 4

This input is similar to the other line level inputs on the amplifier and may be used with a VCR or a second recording unit (e.g. cassette deck).

TONE 6

Switches the tone circuits on and off, including settings for individual sources. Note that the tone LED does not light unless a tone setting has been made. (see page 8).

Control knob, SELECT and ENTER 3 14 13

The control knob has two functions:

- as a volume control, to adjust the output of loudspeakers and headphones connected to the amplifier, and of the pre-amp output (**PRE OUT**).
- when used in conjunction with the **SELECT** and **ENTER** buttons, to customise amplifier settings (see page 8).

Volume control settings

It is important to realise that the position of the volume control is not an accurate indication of the power delivered to your loudspeakers. The amplifier often delivers its full power long before the volume control reaches its maximum position, particularly when listening to heavily recorded compact discs. However the amplifier also has to be capable of giving full power output from much lower level sources, such as tuners and cassette decks. Using these sources, the volume control setting may be much higher before distortion (audible overload) sets in. To compensate for this, the input levels of each source may be individually adjusted to avoid accidental overload (see page 8).

SP1 and SP2 7

These buttons allow you to select and deselect the main (**SP1**) and secondary (**SP2**) set of speakers attached to your amplifier.

The light above each button glows if the corresponding speakers are currently selected. If both lights are out the amplifier will appear not to work, as all speakers are switched off! If both are on, with two pairs of low impedance speakers connected, overloads are more likely. Overloading the amplifier may cause it to shut down because of overheating.

PHONES 1

This socket accepts headphones with an impedance rating between 8Ω and 2kΩ, fitted with a 1/4-inch stereo jack plug. If you wish to listen on headphones only, use the **SP1** and **SP2** buttons (if necessary) to mute the speakers. The headphone socket is always active.

Remote control receiver 9

The remote control's infrared receiver is positioned to the left of the **RECORD** button. Ensure the receiver is in a clear line of sight from the remote control to allow signals to be received.

MODE, UP and DOWN 11 12

These buttons are mainly for use with future optional modules, however the **UP** and **DOWN** buttons are used with the basic A85 amplifier to move the cursor when customising the 'Welcome message' (see page 8).

Recording

With the Arcam A85 it is possible to listen to and record from one source, or to listen to one source while recording another.

Both sets of tape sockets are identical in sensitivity and suitable for use with almost any type of recorder (cassette, CDR, MD, VCR, reel-to-reel, etc.). The record signal is sent to both the **TAPE** and **VCR** output sockets.

RECORD 10

To record the currently selected source, press **RECORD** until the display shows '*RECORD SOURCE*'. After a few seconds the display reverts to showing the volume level and you are ready to record.

To listen to one source while recording another, press **RECORD** again until the display shows '*RECORD*' followed by the name of an input (e.g. '*AUX*', '*CD*', '*TUNER*', etc.). Now press the source selector button on the front panel for the source you wish to record. Your selection is shown on the display for a few seconds, after which it reverts to showing the volume level and you are ready to record.

The **RECORD** button can also be used as a second zone selector, sending a source signal at line level to a second amplifier operating in another room. If you need help with this, contact your Arcam dealer or Arcam customer support.

Tape-to-tape copying (dubbing)

You can perform tape dubbing from **VCR** to **TAPE**, but not from **TAPE** to **VCR**.

For example, to copy from a cassette recorder connected to the VCR socket to a cassette recorder connected to the TAPE 1 socket, first use the **RECORD** button as explained above and select '*RECORD VCR*'. This routes the VCR signal to the TAPE output.

Set the cassette recorder connected to the **TAPE** socket into its record mode and the other to playback mode to start dubbing.

TAPE 5

To play back the recording from a cassette deck attached to the TAPE 1 input, press **TAPE**. '*TAPE 1*' is shown on the display. Selecting this input overrides the other source selectors.

It is also possible to monitor a recording while it is being made, provided your cassette deck is a 3-head type. To do this, press **TAPE**. Switching this button in/out allows an A/B comparison between the source signal and the recorded signal.

Setting up your A85 integrated amplifier

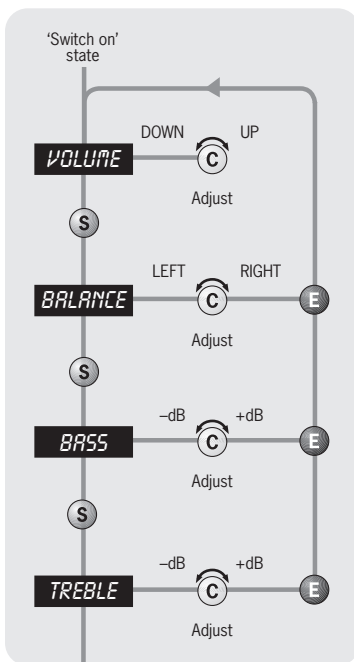

Introduction

The A85 allows you to adjust listening settings to suit your taste, and to customize various features of the amplifier to fit your system. Use this diagram to help you navigate through the settings available.

The **ENTER** and **SELECT** buttons are represented in the diagram by the symbols **E** and **S** respectively. The Control knob is shown as **C**.

Adjusting listening settings

The default display mode is VOLUME, where the control knob is used to adjust sound level.

Press **SELECT** to enter edit mode and cycle through the other sound settings: **BALANCE**, **BASS** and **TREBLE**. When a setting is selected, adjust it with the control knob. Press **ENTER** to fix the change you have made and return to default (volume) mode, or press **SELECT** again to move to the next setting.

Customising amplifier settings

Press **SELECT** until the display shows 'CUSTOMIZE->'. Now rotate the Control knob to choose which setting you wish to alter. Press **SELECT** to adjust the chosen setting with the Control knob.

Press **ENTER** to confirm the adjustment or press **SELECT** to confirm the adjustment and move on to the next item.

Press **ENTER** twice to leave the Customize menu.

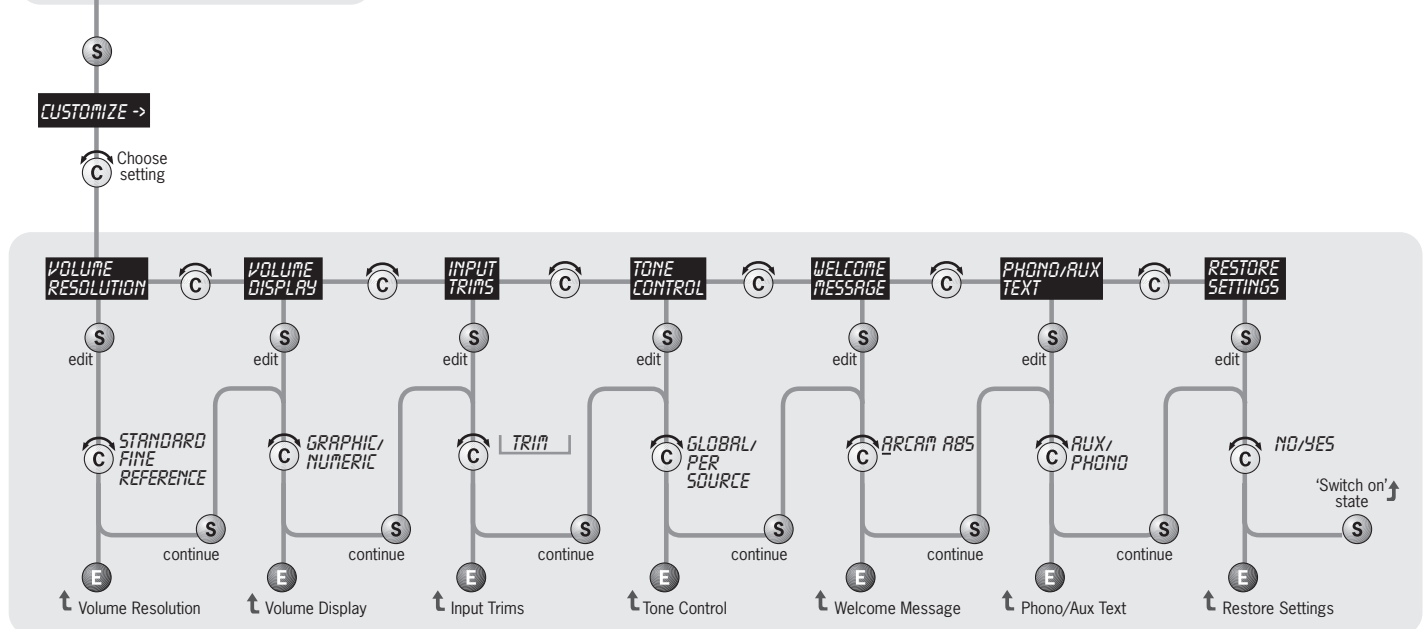

Volume Resolution – **STANDARD**, **FINE** or **REFERENCE**. 'Standard' and 'Fine' represent different levels of volume control sensitivity. The 'Reference' setting gives absolute increments in 0.5dB steps.

Volume display mode – **GRAPHIC** or **NUMERIC** shows the volume either as a bar graph or as a number. If Volume resolution is set to 'Reference' a numeric volume display shows the actual decibel figure.

Input Trims – use the source select buttons and Control knob to set input trims for each source. Input trims are used to compensate for variations in output levels of different source equipment.

Tone Control – **GLOBAL** or **PER SOURCE**. This specifies the scope of changes for 'Bass' and 'Treble' tone settings. The default setting is 'Global' which affects all inputs equally. 'Per source' allows you to set tone controls for individual inputs: once set, the amplifier remembers tone settings for each input.

Welcome message – You can change the power on Welcome message from 'ARCAM A85' to display your name, postcode, etc. When customising the message, use the **UP** and **DOWN** buttons to select the cursor position and the Control knob to change the letter.

Phono/Aux Text – If you have had the optional Phono module added, choose '**PHONO**' so this word is displayed when the input is selected. The default is '**AUX**'.

Restore Settings – this restores all amplifier settings, including Input trims and the Welcome message, to their factory defaults.

Using the remote control

CR-389 Remote Control

The CR-389 remote control gives access to all functions available on the front panel of the A85. It also has controls to operate Arcam CD players, AM/FM tuners and DAB tuners. The remote control transmits Philips RC-5 type codes.

TUNER

These buttons are used to control tuner functions.

Note that the FM/DAB lights indicate into which mode you are switching the remote control. The lights only illuminate for five seconds to conserve battery power. If neither light is illuminated this does not mean that the remote control is not working!

▲ ▼ (UP and DOWN)

Perform the same function as the ▲ ▼ buttons on the front panel (see page 6).

ENTER

Performs the same function as the ENTER button on the front panel (see page 8).

SELECT

Performs same function as the SELECT button on the front panel. It allows you to use the remote's volume switch in the same way you use the control dial on the front panel – to adjust various amplifier settings (see page 8).

Note that pressing + corresponds to turning the Control knob clockwise, – to anticlockwise.

Source selection buttons

These operate in the same way as the source selectors on the front panel of your integrated amplifier.

Power/Standby

Toggles the amplifier between standby mode and full power mode. The power indicator light next to the power button on the front panel is red if the amplifier is in standby, amber while the amplifier is powering up (this only takes a few seconds) and green when the amplifier is powered up.

SP1 and SP2



These buttons allow you to select and deselect the main (SP1) and secondary (SP2) sets of speakers attached to your amplifier (see page 6).

DISP (display)

Cycles through the settings 'Bright', 'Off' and 'Dim'. Turning the display 'Off' generally gives a slight improvement in sound quality.

Volume and (mute)

Press + to increase volume or – to decrease the output volume of the amplifier.

Press  to mute the speaker connections and preamp outputs. Both tape outputs and the headphone socket remain active. Mute is disabled either by pressing  again, or by adjusting the volume.

You can use the remote's volume control in conjunction with the SELECT button to adjust balance, tone and amplifier settings.

CD controls

These offer basic controls of Arcam CD players



NOTE: Remember to install the two supplied AAA batteries before trying to use your remote control!

Do not place anything in front of the IR receiver on the left of the A85, or the remote control may not work.

Installation: P85 power amplifier

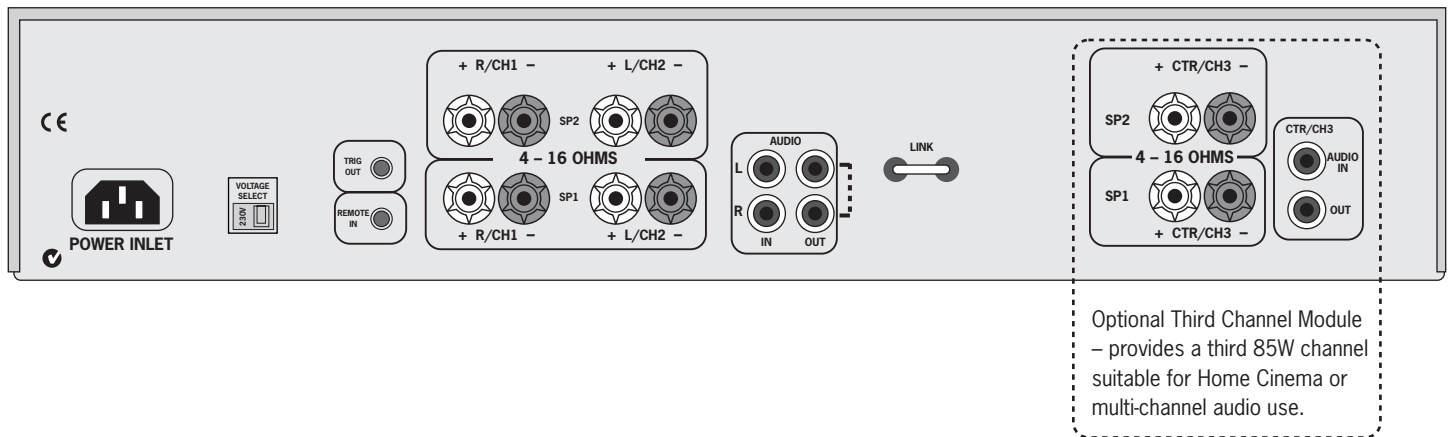

Optional Third Channel Module
– provides a third 85W channel
suitable for Home Cinema or
multi-channel audio use.

Connecting to power, loudspeakers and other equipment

Follow the installation instructions for the integrated amplifier on pages 4–6.

AUDIO IN – Connect this input to the output sockets of your pre-amplifier or the **PRE OUT** sockets of an integrated amplifier.

MONO LINK – The power amplifier can be adapted to provide two mono loudspeaker outputs from a single input. Pull out the link supplied and use it to connect the **L** and **R AUDIO OUT** sockets together. Using one power amplifier per loudspeaker will enable you to bi-amplify bi-wireable loudspeakers.

This is particularly beneficial for top quality stereo installations with a separate pre-amplifier, or where amplifiers are provided for the left, centre and right channel loudspeakers in a five speaker Dolby Pro Logic or Dolby Digital system.

Contact your Arcam dealer for more information.

“Daisy chaining” – The power amplifier can be connected to further power amplifiers to drive more speakers (e.g. those in other rooms or tri-amplified speakers, etc).

Connect the extra power amplifier inputs to the **AUDIO OUT** sockets on the power amplifier, left to left, right to right.

Remote switching

By making a connection from the **REMOTE IN** socket of the P85 power amplifier to the **TRIG OUT** socket of the A85 integrated amplifier, you can use the A85 to switch the power amplifier on and off. If configured in this way, the front panel **POWER** button of the A85 (or the **Power/Standby** button on the remote control) switches both amplifiers on and off together. This facility allows you to conceal the power amplifier yet still control it.

The connecting cable required is a 3.5mm to 3.5mm jack lead (stereo or mono) and it is possible to connect several power amplifiers to an A85 by ‘daisy chaining’ from **TRIG OUT** of one P85 into the **REMOTE IN** of the next.

Three channel option

The power amplifier can be upgraded from stereo to three channels by adding a Third Channel Module: in this case, the model is designated P85/3.

The module offers extra loudspeaker terminals together with a third set of **AUDIO IN** and **OUT** phono sockets and converts the P85 into a 3 x 85W (RMS per channel into 8Ω) amplifier suitable for Home Cinema or multi-channel audio use.

Contact your Arcam dealer for further details.

Using your P85 power amplifier

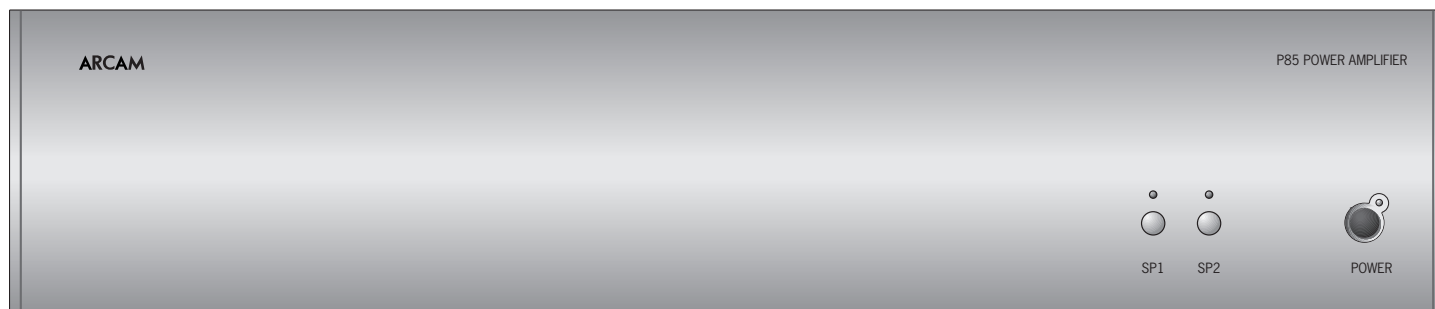

POWER (and power indicator light)

Switches the unit on and off. The light indicates the status of the amplifier.

When you switch your amplifier on, the light glows amber for a few seconds, during which time the speakers are disconnected. The light changes to green when the amplifier is ready for use. A red light means the amplifier is in standby mode.

The light may flash if a fault has occurred – the fault type is shown on the display. You should unplug the amplifier and leave it for a few minutes before reconnecting. If the fault cannot be cleared, unplug your amplifier and contact your Arcam dealer.

SP1 and SP2

These buttons allow you to select and deselect the main (**SP1**) and secondary (**SP2**) sets of speakers attached to your amplifier. An indicator light shows which set of speakers are currently selected.

NOTE: If both lights are out the amplifier will appear not to work, as all speakers are switched off. If both are on, and low impedance speakers are connected, overloads are more likely.

Bi-wiring and bi-amping loudspeakers

Before you start

WARNING: Do not make any connections to your amplifier while it is switched on or connected to the mains supply.

Before switching on please check all connections thoroughly, making sure bare wires or cables are not touching the amplifier in the wrong places (which could cause short circuits) and you have connected positive (+) to positive and negative (-) to negative.

Always ensure that the volume control on your amplifier is set to minimum before starting these procedures.

Bi-wiring your loudspeakers

Bi-wiring improves the sound of your system because it divides the high and low frequency signal currents into separate speaker cables. This avoids signal distortions arising from the high and low frequency currents interacting with one another within a single cable, as in conventionally wired systems.

You will need:

Speakers – with four input terminals each: these will be marked HF (High Frequency) and LF (Low Frequency).

Loudspeaker cables – two pairs of cables per loudspeaker (which may be joined at the amplifier end if your amplifier has only one pair of output terminals per channel). Or, a suitably terminated cable set (a loom, probably prepared by your dealer and capable of being used for bi-wiring in one length).

How to bi-wire loudspeakers

1. Remove the terminal links on the rear of your loudspeakers

WARNING: This step is essential or damage to your amplifier may result which is not covered under warranty.

2. Connect the cables as shown in the diagram below, ensuring correct polarity at all times.

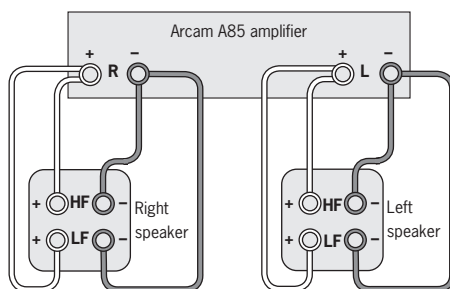

Bi-wiring using one set of connections on amplifier

Bi-amping your system

The performance of your system can be further enhanced over that achieved with bi-wiring, by extending the principle one stage further to include separate amplification for the low and high frequency drive units in each loudspeaker enclosure.

Connect the integrated amplifier to the high frequency (HF) terminals and connect the power amplifier to the low frequency (LF) terminals.

You will need:

Speakers – with four input terminals each (as with bi-wiring): these will be marked HF (High Frequency) and LF (Low Frequency).

Two amplifiers – one of these would be the A85 and the other an Arcam power amplifier (e.g. P85).

Loudspeaker cables – two pairs of cables per loudspeaker or a suitably terminated cable set (a loom, probably prepared by your dealer and capable of being used for bi-amping in one length).

Interconnect cables – one pair of high quality interconnect cables.

How to set up a bi-amped system

1. Remove the terminal links on the rear of your loudspeakers.

WARNING: This step is essential or damage to your amplifier may result which is not covered under warranty.

2. Connect the cables as shown in the diagram below, ensuring correct polarity at all times.
3. Use the interconnect cables to connect the **PRE OUT** sockets of the A85 to the corresponding **AUDIO IN** sockets of the power amplifier.

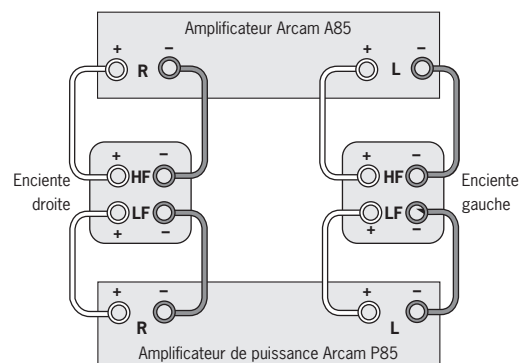

Recommended bi-amping configuration

Service information

Before returning your amplifier for service, please check the following:

Sound cuts out for no reason

If the temperature of the internal heatsink rises above a safe level, then a thermal cutout inside the amplifier will operate.

The power indicator on the front panel flashes and the protection system temporarily removes the power to the speakers. The system resets itself as the heatsink cools down.

Note that because of the high output voltage from a CD player, it is possible to drive the A85 at full power even though the volume is not set at maximum.

Amplifier does not switch back on

The A85 and P85 amplifiers have a protection mechanism which is activated if you switch the unit on immediately after turning it off. If this mechanism activates, wait 30 seconds then try again.

Technical specifications

	A85	P85
Continuous power output, per channel		
Both channels, 8 Ω , 20Hz–20kHz	85W	85W
Single channel, 4 Ω , 1kHz	140W	140W
Distortion, 8 Ω , 80% power, 1kHz	0.005%	0.005%
Inputs		
Phono cartridge (optional module):		
input sensitivity, MM	2.5mV	
input sensitivity, MC	250 μ V	
Line and tape inputs:		
Nominal sensitivity	250mV	700mV
Input impedance	22k Ω	22k Ω
Signal/noise ratio (CCIR)	105dB	112dB
Tone controls, max. boost/cut	\pm 12dB	
Preamplifier outputs		
Nominal output level	700mV	
Output impedance	<3 Ω	
General		
Power consumption (maximum)	800VA	800VA (950VA for P85/3)
Dimensions W x D x H (including feet)	435 x 340 x 100mm	435 x 320 x 100mm
Weight (net)	9kg	9.5kg (10.5kg for P85/3)
Weight (packed)	10.5kg	11kg (12kg for P85/3)
Supplied accessories	mains lead CR-389 remote control 2 x AAA batteries	mains lead
E&OE		

Continual improvement policy

Arcam has a policy of continual improvement for its products. This means that designs and specifications are subject to change without notice.

NOTE: All specification values are typical unless otherwise stated.

Guarantee

Worldwide Guarantee

This entitles you to have the unit repaired free of charge, during the first two years after purchase, at any authorised Arcam distributor provided that it was originally purchased from an authorised Arcam dealer or distributor. The manufacturer can take no responsibility for defects arising from accident, misuse, abuse, wear and tear, neglect or through unauthorised adjustment and/or repair, neither can they accept responsibility for damage or loss occurring during transit to or from the person claiming under the guarantee.

The warranty covers:

Parts and labour costs for two years from the purchase date. After two years you must pay for both parts and labour costs. The warranty does not cover transportation costs at any time.

Claims under guarantee

This equipment should be packed in the original packing and returned to the dealer from whom it was purchased, or failing this, directly to the Arcam distributor in the country of residence.

It should be sent carriage prepaid by a reputable carrier – NOT by post. No responsibility can be accepted for the unit whilst in transit to the dealer or distributor and customers are therefore advised to insure the unit against loss or damage whilst in transit.

For further details contact Arcam at:

Arcam Customer Support Department,
Pembroke Avenue, Waterbeach, CAMBRIDGE
CB5 9PB, England.

Telephone: +44 (0)1223 203203

Fax: +44 (0)1223 863384

Email: support@arcam.co.uk

Problems!

If your dealer is unable to answer any query regarding this or any other Arcam product please contact Arcam Customer Support on +44 (0) 1223 203203 or write to us at the above address and we will do our best to help you.

On-line registration

You can register your Arcam product on line at:

www.arcam.co.uk/reg

Other languages

Check the Arcam website (www.arcam.co.uk) for further languages.

Free Manuals Download Website

<http://myh66.com>

<http://usermanuals.us>

<http://www.somanuals.com>

<http://www.4manuals.cc>

<http://www.manual-lib.com>

<http://www.404manual.com>

<http://www.luxmanual.com>

<http://aubethermostatmanual.com>

Golf course search by state

<http://golfingnear.com>

Email search by domain

<http://emailbydomain.com>

Auto manuals search

<http://auto.somanuals.com>

TV manuals search

<http://tv.somanuals.com>