

35mm FOR THE PROLETARIAT:

A Modern User's Guide To The Argus A/A2 Camera



**by
Hrad Kuzyk**

Download this book for free at <http://www.TheArgusA.com/>

Preface

For the sake of expediency, any Argus A- or A2-type camera will henceforth be referred to simply as “an Argus.” The author realizes that Argus manufacturers produced various types of cameras and that, if mentioned in casual conversation, the word Argus will probably conjure the image of the far more popular C3, not an A or A2. He nonetheless considers this compromise necessary in order to prevent the reader from being continuously bludgeoned by such windy phrases as “the Argus A and A2 family of related cameras, including the Argus FA.” Further, the Argus A2B is sometimes called an A2, even in official Argus literature, although every camera with an extinction meter and a two-position focus has a serial number that is prefixed by “A2B”. For this reason, this text will refer to all such cameras as A2Bs. The term A2 is reserved to mean the family of cameras that came with the extinction meter, namely the pre-war A2B, the A2F, and the post-war A2B.

This book is intended to be a user’s guide, not a collector’s guide. As such, it does not concern itself with current street value, scarcity, condition rating, or other such collector information. While there is much in this text to interest a collector of Argus cameras, it concentrates predominantly on those issues that would be of importance to a user. Further, the information in this text was gathered by studying a cross section of Argus cameras and determining their similarities and differences. Therefore, errors or omissions may have occurred, and the author wholeheartedly apologizes for any problems this may cause.

This text assumes that the user has a rudimentary knowledge of photography. This includes an understanding of apertures, shutter speeds, film speeds, and lens care, among other things.

The repair techniques described in this text are not those one would use on an expensive camera. However, since using the proper tools and techniques would exceed the cost of the camera, your author has chosen to describe cheaper, less traditional, methods that are effective nonetheless.

Other vintage cameras also deserve their own modern following. Cameras like the Argus C3, Argus C4, Universal Mercury II, and Kodak 35RF are inexpensive and easy to obtain today. Each of these can be easily repaired and used with off-the-shelf 35mm film. Take the opportunity to research these cameras as well as the Argus A.

Finally, the use of the word “proletariat” in the title deserves an explanation. This outdated term was particularly popular in socialist propaganda in the 1930s, when the Argus A was first introduced. The members of the proletariat, also known as the proles, are the exploited working class who are forced to trade manual labor for money in order to survive. The Argus A was the first 35mm camera designed to make photography affordable enough so that anyone, even the proletariat, would be able to purchase and use it. The use of this term does not imply any socialist leanings in either the author or the persons, companies, or groups mentioned in this text.

Many thanks to both Raya Kuzyk and Guma Chernyk for help in editing this text.

Edition of 5 June 2004

© Copyright 2004 Hrad Kuzyk
All Rights Reserved.

Download this book for free at <http://www.TheArgusA.com/>

Table of Contents

<u>CHAPTER</u>	<u>SUBJECT</u>
1	WHY THE ARGUS A/A2 CAMERA?
2	HISTORY
3	MODELS AND VARIATIONS
4	PARTS OF THE CAMERA
5	USER'S GUIDE
6	ACCESSORIES
7	RESTORATION AND REPAIR
8	TRICKS AND MODIFICATIONS
9	FINDING AN ARGUS IN GOOD SHAPE
10	FURTHER READING
APPENDIX A	ARGUS A PATENT
APPENDIX B	BIBLIOGRAPHY AND REFERENCES

Download this book for free at <http://www.TheArgusA.com/>

1 Why the Argus A/A2 Camera?

Why should anyone be interested in a camera whose latest model has been out of production for over 50 years? Certainly not for ease of use. Point-and-shoot cameras made today are far more user-friendly. Not for quality of the lens or accuracy of the shutter. Both were fine for an amateur in their day and age, but are now easily surpassed. Not for the additional features. The Argus doesn't have double-exposure protection, available on even disposable cameras these days. Part of the answer lies in the key statements of the above sentences: "made today," "in their day and age," and "these days."

The Argus was born at a time when amateur photography was beginning to take hold of the American public. Certainly, the Leica and the Contax are more well known, but most 35mm photographers in the late 1930s and 1940s were snapping away with an Argus. If a GI took a camera with him when he went to fight Hitler, he most likely took an Argus. The subsequent popularity of the Argus solidified that of the 35mm format.

Compact, reliable, cheap, and rugged, more amateur 35mm photographers of the time cut their teeth on an Argus than any other camera. Such ancestry makes the Argus one of the most historically important 35mm cameras ever produced.

Designed to be sold in Depression-era America, the Argus is a camera stripped to its bare essentials. There are no wide-angle nor telephoto lenses. Most models can't accommodate a flash. There is no quick-throw lever, and every frame must be manually wound. It is furnished with three simple controls: focus, shutter speed, and aperture size.

While vintage Leica and Contax cameras also offer photographic purity, they are a considerably harsher investment in money, time, and effort. The Argus is forgiving in this respect, and can often be purchased for ten dollars or less. Due to the theories on "product quality" in the 1930s, the materials and methods used to build these cameras were sound enough to withstand the test of time; most require just a touch of care to work like new again. Acquiring film is not a problem either, for the Argus uses the same 35mm film that is as popular today as it was after WWII. Finding an Argus and getting it in working order, therefore, is easier and cheaper than with almost any other camera.

The simplicity of the Argus also makes it a very easy camera to repair yourself. The increasing complexity of cameras has made the hobby of amateur camera restoration a waning one, but it is very satisfying nonetheless. Restoring an older camera is the best way to get to know it well, and to gain a deeper understanding of cameras in general. The Restoration and Repair chapter of this book deals with common repairs. The Finding an Argus in Good Shape chapter will show you how to identify a camera that can be easily repaired prior to purchase.

In addition to simple repairs, modifications can be made to an Argus to turn it into a more flexible camera. By swapping parts from other Argus models, one can easily combine multiple features onto one camera. Argus As can also be adapted into pinhole cameras, then very easily returned to their original state. Want an accessory shoe to hold a range finder or light meter? No problem! With a little creativity the Argus can easily be adapted to a wide range of uses and situations.

So why the Argus? Simple: It's an easy-to-maintain, modifiable and historically significant camera that uses readily available film.

Besides, at roughly \$10 a pop, why not?

Download this book for free at <http://www.TheArgusA.com/>

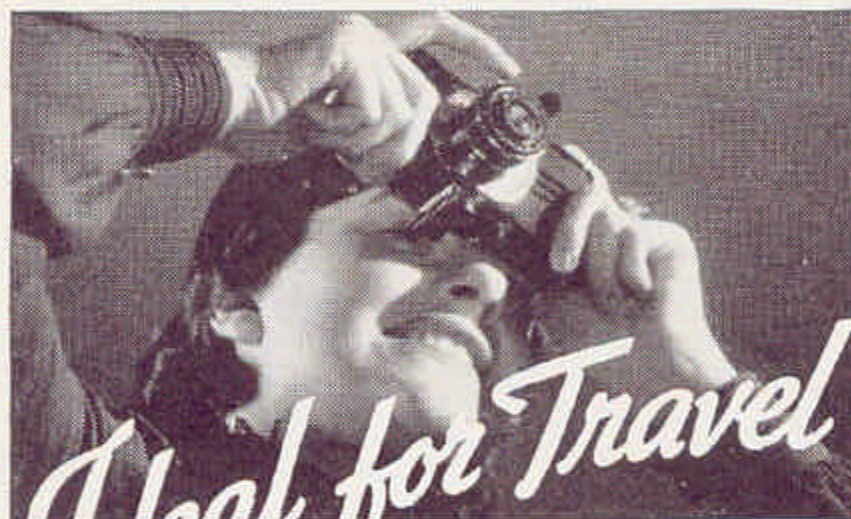

Ideal for Travel

THE REVOLUTIONARY
argus
CANDID CAMERA

Take an Argus and bring back crisp, clear pictures of your travels. So compact, so easily carried and always ready for instant use. A real "candid camera."

Fast f 4.5 triple Anastigmat lens gets dark day, night, stage and natural color pictures. Simple operation—requires only two focus settings. Shutter speeds 1/25 to 1/200 sec. Stops action. Uses inexpensive 35 millimeter motion picture film—36 exposures without reloading. A revolutionary camera at a revolutionary price—

*See the Argus at your camera dealer's
or write direct for further information.*

INTERNATIONAL RESEARCH CORP.
144 Fourth Ave. Ann Arbor, Mich.

ONLY
\$12⁵⁰

May 1937

Download this book for free at <http://www.TheArgusA.com/>

2 History

The concept of a compact 35mm camera was born in the early 1920s. It was then that Oscar Barnack of E. Leitz, Inc. developed a portable and accurate camera based on readily available 35mm film, then the standard for the movie industry. This camera, the Leica, took the world of amateur photography by storm from the day of its introduction in 1925 at the Leipzig Fair. Encrusted with knobs, dials, levers, and buttons, and not at all resembling any camera that came before it, the Leica was the ultimate gadget for the rich and stylish. Cameras were once large obtrusive objects that required considerable technical knowledge to operate, but with the Leica, amateurs could easily take high-quality, candid photos, then slip their cameras back into their jacket pockets. Still, the Leica's exorbitant price, running up to \$200, prevented it from finding its way into the common man's hands.

In the early 1930s, the Leica drew the attention of Charles A. Verschoor during a trip to Europe. Verschoor was an American businessman who, along with other local businessmen, established a radio manufacturing business in Ann Arbor, Michigan in 1931. International Radio Corporation (IRC) was responsible for the Kadette, the first AC/DC mantle radio on the market.

Radio first began to mature in the late 1920s, and was considered a sound investment during the Depression era. For a one-time payment, your radio would play news, music, or entertainment daily for free! Using a relatively new plastic called Bakelite to mold the cases, IRC could cheaply produce radios and sell them for a decent profit.

The problem with radio manufacturing, however, was its reliance on the seasons. Customers, driven stir-crazy during the winter, would rush outside to meet the spring and, as a result, radio sales would dwindle until autumn forced consumers indoors again. Before the advent of air conditioning, people's behavior was still tied to the weather, and their spending habits followed. To keep his factory and salesmen working all year, Verschoor searched for a product that could be cheaply manufactured and sold during the warmer half of the year. Amateur photography was starting to take hold in America, but was generally restricted to box-type cameras like the Kodak Brownie and the UniveX A. Verschoor decided to market an inexpensive Leica-inspired model and set his engineers to design one.

The Argus was designed to use the new Kodak 35mm daylight loading cartridge. This film cassette entered the market in late 1934 with the first camera designed to use it, the Kodak Retina. The new cartridge could be reloaded in a darkroom with surplus 35mm movie film, which was often plentiful and cheap. When Kodak introduced Kodachrome, the first color film, it was only available as rollfilm in the Kodak 35mm film cartridge, boosting this film format's popularity. This cartridge was also the first that could easily be loaded into a camera in daylight. Such simplicity played a factor in the success of the Argus. The symbiotic relationship between Argus cameras and Kodak's 35mm film cartridges boosted the popularity of both. The Argus A, and its more famous successor, the Argus C/C2/C3, are the primary reasons that the 35mm film format was established as firmly as it was, despite the plethora of similar formats that have been introduced and forced upon photographers in the last seventy years (UniveX 00, Kodak 828, 127, 126, 110, Disc, APS, etc...).

Download this book for free at <http://www.TheArgusA.com/>

IRC's engineers had extensive experience molding Bakelite and took advantage of this knowledge in designing the body of the Argus. Bakelite allowed the camera body to be cheaply decorated with a distinct Art Deco flair. Gustave Fassin, an engineer for IRC, is generally believed to have designed the Argus, though the patent is credited to Verschoor and makes no mention of Fassin.

The Argus, priced at only \$12.50, was a success from its debut in early 1936; IRC later claimed to have sold 30,000 cameras in the first week alone. Prospects seemed so promising that Verschoor decided to give up radio manufacturing altogether and sold off the patent rights for the Kadette to the Radio Corporation of America, also known as RCA. To reflect this redirection in corporate focus, IRC changed its name from International *Radio* Corporation to International *Research* Corporation.

In 1937, the Argus A was followed by the Argus AF and the Argus B, which were two variations on the same theme. The AF, at \$15.00, had an infinitely adjustable focusing mount but the same shutter and lenses, while the B, at \$25.00, had a higher quality Prontor II shutter imported from Germany. The B was dropped that same year because of lack of consumer interest and the AF was withdrawn from production in 1938, presumably to prepare for the introduction of the A2F.

Riding on the heels of this unparalleled success, IRC introduced other models, such as the unrelated Argus A3 and Argus C. Also designed by Gustave Fassin, the Argus C-type camera would become the bread and butter of the Argus line. Nicknamed "the brick" for its boxy appearance, it would stay in production until 1966—an unbelievable 28 years! This was a sturdy camera with a coupled rangefinder and a respectable f/3.5 Cintar lens, and it was IRC's very successful attempt at entering the market of medium-cost cameras. Kodak, in response to IRC stealing its market, heavily modified one of its cameras to compete with the C3. This jury-rigged contraption became the Kodak 35RF, which still couldn't match the C3 in either price or features.

To make amateur photography easier, in 1939 IRC introduced the Argus A2B (at \$12.50) and the A2F (at \$15.00). These were nearly identical to the Argus A and AF with only an integral extinction meter and exposure calculator added. With this "miraculous" device, the user didn't need a light meter or any knowledge of photography to take a decent picture. Just look through the meter, add the film speed and lighting conditions to the calculator, and an assortment of f-stop/shutter speed combinations are suggested to produce a serviceable picture! The Argus A2F was discontinued in 1941, probably due to the effort involved in manufacturing the focusing mount. Production of the A2B, with minor changes, continued until 1950.

To take advantage of the recently invented flashbulb, Verschoor decided to produce a model of the Argus that could use a flash, thus giving life to the Argus AA in 1940. The Argus A adapted poorly to the addition of a flash, however, as many of the components of the flash mechanism were carefully assembled by hand. The shutter had to be completely redesigned and the two-position focus gave way to "fixed focus." The lens shrank in size to f/6.3, probably to make room for flash components. This weak adaptation did not last long, and the AA was dropped in 1942. By then, International Research Corporation had changed its name to Argus International Industries, Inc. in order to identify the company with its product.

Then came December 7th, 1941. With the Japanese attack on Pearl Harbor, the United States began to mobilize for war. It is impossible to underestimate the effect that

World War II had on American industrial capability, methods, and design. Massive government contracts were awarded to every American industry. Unheard-of sums of government cash were dumped into military-oriented research and development. New materials and techniques of manufacture that would never have been considered before suddenly became popular.

As an American manufacturer of optical equipment, the Argus corporation benefited from this economic spurt in many ways. It began to produce a variety of optical equipment for military use, like the Argus Observation Scope, retained with others in the Argus line of products after the war. In addition, the US Army put in an order for 50,000 C3 cameras to sell in its Post Exchanges. The military showed its appreciation for the Argus corporation's contribution to the war effort by awarding the company the Army-Navy E Award for production a total of five times.

The US emerged from World War II a manufacturing powerhouse, one of only two superpowers, and the only country on earth with nuclear weapons. Because of these and other factors, the patriotic American consumer became a different person as well. Due to economic depression and wartime rationing, consumers had been restrained for the previous fifteen years. The post-war economic boom let them know that they didn't have to settle for second best any more. The modern design movement, greatly influenced by new materials and mass production techniques conceived during the war, began to create inexpensive, stylish American products of decent quality, and the public went mad for them. In response to the wave of nationalism that was sweeping the country, Argus dropped the "International" in its name in 1945 and became simply Argus Industries, Inc.

This did not bode well for the A2B, the only Argus A-type camera manufactured at the end of the war. Designed to be affordable for Depression-era America, the A2B didn't offer a rangefinder or flash capability, and had only a two-position focus. The f/4.5 lens that seemed so fast before the war was now slower than lenses available on other cameras. In addition, the art deco styling that made the Argus so smart at its introduction now seemed dowdy and old fashioned. With a different shutter and fluoride-coated lenses, the A2B was retained in the Argus line as a low-end camera, suitable for college students and amateurs.

No economic boom lasts forever, though, and the recession of 1948-49 hit all of America hard. Argus shareholders needed a scapegoat, and in 1949, after a brief power struggle, the shareholders brought in Robert E. Lewis to head the company. Lewis and his boys decided to phase out every old line of cameras, including the Argus A2B, and began to design new ones. The only camera saved from the slaughter was the popular C3. These were the ignoble circumstances under which the Argus A2B left the company, now again renamed Argus Cameras, Inc.

This was not the end for the Argus A-type camera, however. Possibly to fill in the gap for a low-cost camera while other cameras were being developed, Argus introduced the FA, which was another flash version of the A. But the FA only lasted from 1950 to 1951. Its successor, the totally redesigned and restyled A4, arrived on dealers' shelves in 1953 and became the new low-cost representative of the Argus line. The A4 was a completely new design and shared nothing but a name with its predecessors.

One can see that the Argus A was very much a product of the times, and it was once those times changed that the age of the Argus A ended.

All did not go well with Argus Cameras, Inc. after the demise of the A/A2 line. Higher quality and cheaper cameras from West Germany and Japan began to flood the market, and, as a result, the company started hemorrhaging money. Argus enjoyed only a modest success with the C4/C44, which was intended to become the new workhorse of the Argus line. Successive attempts to update the C3 were not well-received by the consumer, who preferred the original to the updated models. The company was passed around from owner to owner.

Argus is still around today (2004) and you can visit them on the internet at “www.arguscamera.com”. They produce an assortment of 35mm and digital cameras, webcams, and digital video cameras. Unfortunately, they no longer offer the Argus A.

GET HIGH PRECISION AT *low cost...*



ARGUS
MODEL A

only
\$12.50

ONLY 5" LONG,
WEIGHT ONLY
14 OZ., SIMPLE TO
OPERATE.

Favorite of thousands,
the smart, light, compact
Argus goes along
in pocket or case when
bulky, complicated
cameras are left at
home.

● You'll take the ARGUS on hiking trips,
camping trips, fishing trips, to parties,
sports and night stage events. You'll enjoy
its simplicity and precision. You'll be
delighted with its clear, sharp negatives,
which enlarge perfectly any size up to 8x10,



argus SPEED CAMERA

● SAVE ON CAMERA, FILM AND
PRINTS—TAKE ALL THE PICTURES
YOU LIKE... 200 SHOTS FOR AS
LITTLE AS \$1.50 IF YOU LOAD WITH
35 MM BULK FILM.

Fast action shots...
unposed groups...
portraits... indoor
scenes... rainy-day
scenes... night stage
shots... full color or
black and white.

(Model AF with precision-focusing mount
\$15.00)

The ARGUS has a fast f:4.5 triple Anastigmat lens; 1/25 to 1/200-sec. shutter speeds. Uses 35 mm movie film... 36 exposures to one loading. Standard 2 3/4 x 4 1/4 enlargements for as little as a penny a picture if you print them yourself on the ARGUS Speed Printer.

ARGUS Model C... ONLY \$25

Versatile, high-precision camera with built-in range finder (split-image sextant type); behind-the-lens shutter; Speeds 1/5 to 1/300-sec., including bulb; fast f:3.5 Cintar Anastigmat lens (interchangeable); continuous helical focusing, 3 1/2 ft. to infinity. Perfect enlargements up to 11x14 or greater.

See the nearest ARGUS dealer!



Size 3 1/4 x 2 1/4 x 2
Weight 2 1/2 ounces

INTERNATIONAL RESEARCH CORPORATION • 230 FOURTH STREET • ANN ARBOR, MICH.

October 1938

Download this book for free at <http://www.TheArgusA.com/>

3 Models And Variations

This section of the book is neither a detailed list of the various serial numbers, nor a catalog of every minor variation. Rather, it is a brief overview of the various Argus models produced.

In the early years of the Argus, several low-production-run variations were manufactured in an effort to further explore the camera market. These included the Military Argus, in olive-drab plastic with painted, green hardware, and the Gold Argus, with brass hardware rather than chrome and a brown body. There are also persistent and often valid reports of other colors of Bakelite, such as ivory, grey, tan, green, brown, etc. Trying to document all of these variations, however, is equivalent to hunting for the Abominable Snowman. Rumors will persist, legends will be passed from generation to generation, and fuzzy photos will continue to point to “irrefutable” evidence. Cataloging these deviant models, though, is not the purpose of this book. The author is content to give an overview of just the main models and leaves that arduous task to some other brave soul.

It must be pointed out, though, that there is no evidence of an Argus body being painted by the manufacturer. Any painted Argus is an aftermarket attempt at changing the color.

The parts commonality of the Argus raises another issue. In the sixty-odd years since the first camera rolled off the assembly line, many an amateur repairman has cannibalized parts from one camera to fix another. The Back Cover of the last camera made in 1951, for instance, would fit the first prototype made in 1936, though they are of a different style.

Several of the later Argus As and pre-war A2Bs have interesting variations in their Face Plate design. These are thought to be the result of the Argus corporation trying to make as many cameras out of spare parts as possible when WWII began and camera production stopped.

Keep these things in mind when evaluating a camera and don't jump to conclusions. The best rule of thumb when dealing with an Argus is as follows: If you even suspect that your camera is a rare and valuable variation, don't mess with it!

Argus A



Focus Type: 2 Position (6ft - 12ft and 12ft - Infinity, later 6ft - 18ft and 18ft - Infinity)

Years Manufactured: 1936 - 1941

Introductory Price: \$12.50

Approximate Introductory Price in 2003 Dollars: \$160.00

Serial Number Range: 1037 - 211589

Shutter Type: Pre-war Ilex Precise

Lens Speed: f/4.5

Aperture Settings: f/4.5, 5.6, 8, 11 (later f/4.5, 6.3, 9, 12.7, 18)

Shutter Speeds: 1/200th sec, 1/100, 1/50, 1/25, B(ulb), T(ime), (top speed later dropped to 1/150th sec)

Extinction Meter/Calculator: No

Flash Synch Tubes: No

Pressure Plate: Fixed

The original model of the camera as envisioned by its creators. The first 30,000 – 35,000 models had no Tripod Socket and had a thinner Rewind Knob. Early models also had only an upper Sprocket Wheel, not both. This camera primarily had two Face Plates throughout its lifetime; an all black one, and a black and brass one. A third Face Plate, identical to that of the pre-war A2B and A2F, was also used on some of the very late models.

As other models were introduced, the price dropped from \$12.50 to \$10.00. Most of the colored models are early Argus As, probably to test the consumer market for interest when they were first introduced.

Download this book for free at <http://www.TheArgusA.com/>

Argus AF



Focus Type: Variable from 1¼ to Infinity ft
Years Manufactured: 1937 - 1938
Introductory Price: \$15.00
Approximate Introductory Price in 2003 Dollars: \$190.00
Serial Number Range: 5000 - 70138
Shutter Type: Pre-war Ilex Precise
Lens Speed: f/4.5
Aperture Settings: f/4.5, 5.6, 8, 11
Shutter Speeds: 1/200th sec, 1/100, 1/50, 1/25, B(ulb), T(ime)
Extinction Meter/Calculator: No
Flash Synch Tubes: No
Pressure Plate: Fixed

The first variant of the original, the AF is identical to the Argus A except that the two-position focus Neck was traded for a variable version with a focal length from 15 inches to infinity. This rendered the portrait and copy lens attachments unnecessary and greatly increased the photographic flexibility of the camera. This model only came with the black and brass faceplate.

Download this book for free at <http://www.TheArgusA.com/>

Argus B



Year Manufactured: 1937

Introductory Price: \$25.00

Approximate Introductory Price in 2003 Dollars: \$320.00

Serial Number Range: Middle A Range

Shutter Type: Prontor II

Lens Speed: f/2.9

Aperture Settings: f/2.9, 3.5, 4.1, 5.6, 8, 11, 16

Shutter Speeds: 1/175th sec, 1/100, 1/50, 1/25, 1/10, 1/5, 1/2, 1, B(ulb), T(ime)

Extinction Meter/Calculator: No

Flash Synch Tubes: No

This distant cousin was a fancier version of the Argus A, which featured a higher-quality Prontor II shutter rather than the standard Ilex Precise. The Prontor II shutters were imported from Germany, and the start of hostilities in Europe probably hindered their further export. This, combined with the rather high cost, was the reason that the B was dropped from the product line. The great advantage of the Prontor II shutter was the longer shutter speeds (up to one second) and the addition of a self-timer.

The Argus B is now a genuine collectors' item. For this reason alone, one should not attempt amateur repairs or modifications to this camera. The Prontor II shutter on the Argus B is unique from other Prontor II shutters in that the words "Argus Anastigmat" were printed written directly on the faceplate.

The Argus B will not be addressed in this text, merely because the Prontor II shutter is so different from the Ilex Precise.

Download this book for free at <http://www.TheArgusA.com/>

Pre-War Argus A2B

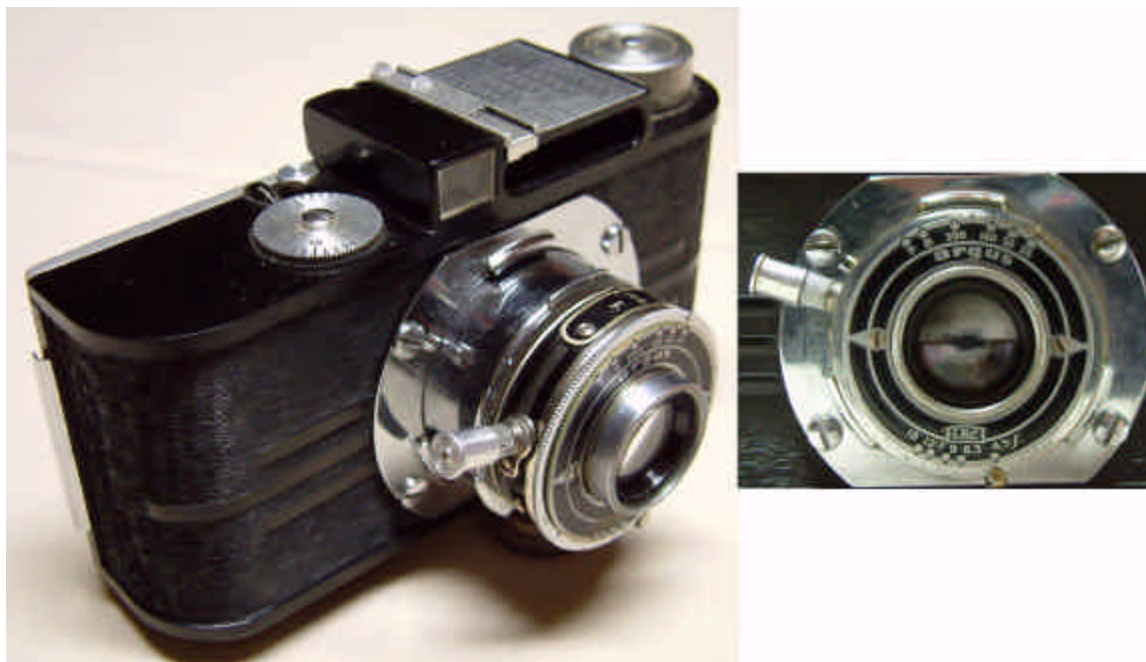

Focus Type: 2 Position (6ft - 18ft and 18ft - Infinity)

Years Manufactured: 1939 - ~1945

Introductory Price: \$12.50

Approximate Introductory Price in 2003 Dollars: \$165.00

Serial Number Range: ~56215 - 244601

Shutter Type: Pre-war Ilex Precise

Lens Speed: f/4.5

Aperture Settings: f/4.5, 6.3, 9, 12.7, 18

Shutter Speeds: 1/200th sec, 1/100, 1/50, 1/25, B(ulb), T(ime)

Extinction Meter/Calculator: Yes

Flash Synch Tubes: No

Pressure Plate: Fixed

It was with the introduction of the A2 cameras that the Argus truly became easy to use. The integral Extinction Meter allowed anybody to take decent photos under various lighting conditions. As the Meter does not wear out with time or use, it can still be used to take decent photographs today. The pre-war A2B shares the same black and chrome faceplate as the A2F. With the A2 line of cameras, Argus also replaced the Trigger with a Shutter Plunger that screwed directly into the cable release port. This was not a cost-saving measure, but a stylistic decision. The Shutter Plunger, which must be unscrewed to attach a cable release, was often lost or broken, and this part should be considered when looking to purchase such a camera.

Download this book for free at <http://www.TheArgusA.com/>

Argus A2F



Focus Type: Variable from 1¼ to Infinity ft
Years Manufactured: 1939 - 1941
Introductory Price: \$15.00
Approximate Introductory Price in 2003 Dollars: \$200.00
Serial Number Range: 22760 - 39031
Shutter Type: Pre-war Ilex Precise
Lens Speed: f/4.5
Aperture Settings: f/4.5, 6.3, 9, 12.7, 18
Shutter Speeds: 1/200th sec, 1/100, 1/50, 1/25, B(ulb), T(ime)
Extinction Meter/Calculator: Yes
Flash Synch Tubes: No
Pressure Plate: Fixed

The A2F was the most feature-laden version of the Argus. In addition to the integral extinction meter/calculator of the A2B, it offered the variable focusing distance of the AF. It shared the black and chrome faceplate with the A2B, as well as its precarious Shutter Plunger.

Download this book for free at <http://www.TheArgusA.com/>

Argus AA

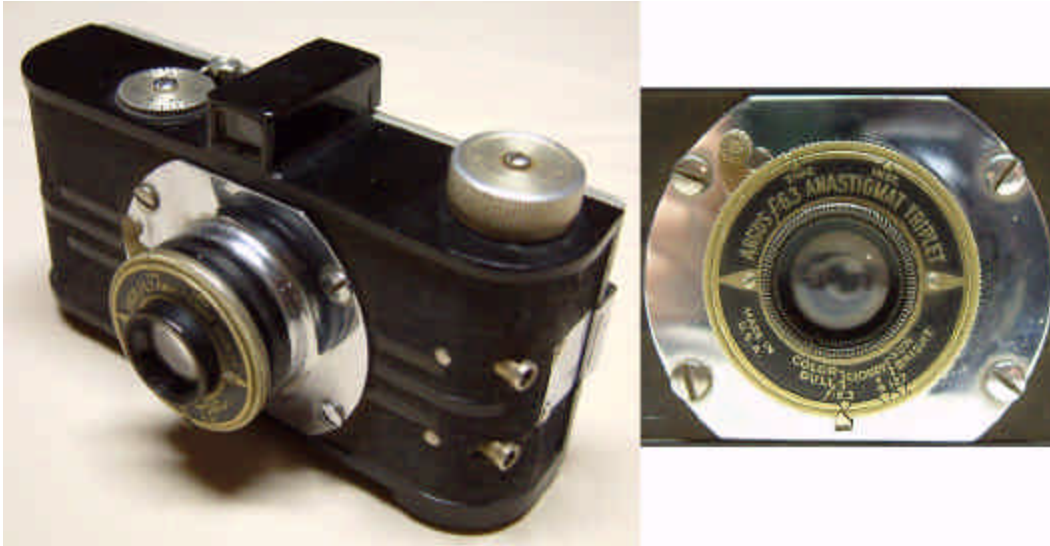

Focus Type: Fixed Focus

Years Manufactured: 1940 - 1942

Serial Number Range: 500000 - 513250

Shutter Type: Custom for Argus AA

Lens Speed: f/6.3

Aperture Settings: f/6.3 (Dull/Color), 9 (Cloudy), 12.7 (Sun/Bright)

Shutter Speeds: Time, Inst.

Extinction Meter/Calculator: No

Flash Synch Tubes: Yes

Pressure Plate: Fixed

The entire Shutter and Neck assembly was redesigned to incorporate a flash mechanism, and that flash is the AA's only truly redeeming feature. This redesign made construction labor-intensive and therefore expensive, and rendered many of the camera parts unique to this model. The smaller lens, the single focal length, the scarcity, and the parts-incompatibility make this model the least desirable in terms of restoration.

Download this book for free at <http://www.TheArgusA.com/>

Post-War Argus A2B



Focus Type: 2 Position (6ft - 18ft and 18ft - Infinity)

Years Manufactured: ~1945 - 1950

Introductory Price: \$29.00 (includes carrying case and excise tax)

Approximate Introductory Price In 2003 Dollars: \$270.00

Serial Number Range: ~56215 - 244601

Shutter Type: Post-war

Lens Speed: f/4.5

Aperture Settings: f/4.5, 6.3, 9, 12.7, 18

Shutter Speeds: 1/150th sec, 1/100, 1/50, 1/25, B(ulb), T(ime)

Extinction Meter/Calculator: Yes

Flash Synch Tubes: No

Pressure Plate: Floating

Argus made several updates to the pre-war A2B to face the new consumer landscape of post-World War II America. Taking advantage of the technical innovations brought about by the war, Argus Industries simplified the Shutter mechanism and fluoride-coated the lenses. The top speed of the redesigned Shutter dropped from 1/200th to 1/150th of a second. This Shutter had a completely new faceplate, returned to the lever-styled Trigger, and lost all parts commonality with previous Shutters. The Lens Assembly was slightly enlarged as well, making the early filters unusable with this camera.

Despite these innovations, the post-war A2B was clearly the lowest in the manufacturer's line of cameras. It was advertised as an amateur or college student camera.

Download this book for free at <http://www.TheArgusA.com/>

Argus FA

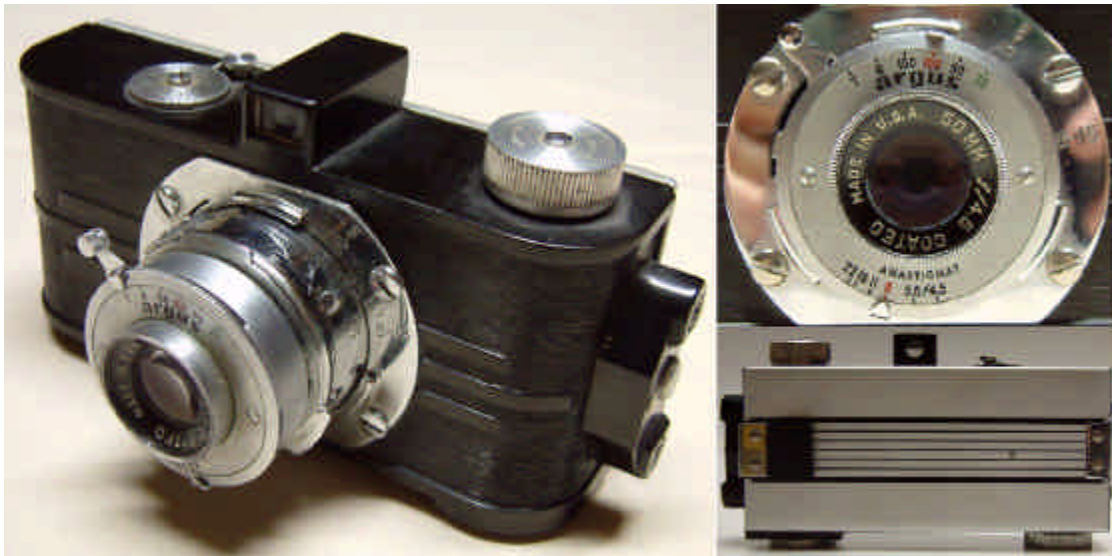

Focus Type: 2 Position (6ft - 15ft and 15ft - Infinity)

Years Manufactured: 1950 - 1951

Introductory Price: \$29.00

Approximate Introductory Price in 2003 Dollars: \$220.00

Serial Number Range: Year and Month of Manufacture

Shutter Type: Flash-modified, post-war

Lens Speed: f/4.5

Aperture Settings: f/4.5, 5.6, 8, 11, 16, 22

Shutter Speeds: 1/150th sec, 1/100, 1/50, 1/25, B(ulb), T(ime)

Extinction Meter/Calculator: No

Flash Synch Tubes: Yes

Pressure Plate: Floating

This last model was a stopgap effort to use leftover Argus A parts and provide a low-end flash camera while a replacement was being designed. This does not detract from the FA in any way. Unlike the previous flash model, the AA, this camera had a two-position focus and full-sized f/4.5 lens. It is unique in that it was the only model in which the two-position focus was actually labeled. The rear door of this camera also featured a new design on the back, a set of five parallel lines bordered by two thicker ones.

Download this book for free at <http://www.TheArgusA.com/>

argus SCORES AGAIN!

TWO SENSATIONAL NEW MODELS

(ALL-AMERICAN MANUFACTURE)

New Style BUILT-IN EXPOSURE METER

Automatically computes lens and shutter speeds



MODEL A2: Certified f/4.5 triple Anastigmat lens, 1/25 to 1/200 sec. shutter speeds. Uses 35 mm movie film . . . 18 or 36 exposures to one loading.

\$1250



AGAIN Argus Scoops the Candid Camera Field by Providing Amazing and Exclusive Improvements at NO INCREASE IN PRICES

No other popular priced 35 mm miniature camera has the built-in Self-Calculating Exposure Meter which eliminates all chance of error by quickly giving you proper shutter speed and aperture setting without need for involved computations or guesswork. It is the simplest of all calculators . . . self explanatory . . . easy to operate — if you can read you can work it.

These two beautiful and compact miniature cameras are both high precision instruments; more complete in mechanical features, that assure good results, than many cameras selling for several times their price.



MODEL A2P, with Calculated Focusing Mount. Certified f/4.5 triple Anastigmat lens, 1/25 to 1/200 sec. shutter speeds. Uses 35 mm movie film . . . 18 or 36 exposures to one loading.

\$1500

Accurate as a Slide Rule—Simple as A B C

Now you can take every type of candid camera shot with confidence that you are going to get good results—night shots, table-top photography, portraits, natural-color pictures for life size projection, enlarging, slide-making or photomicrography. Ask your dealer for a demonstration. Over 40 fascinating accessories make Argus photography a thrilling hobby. Write for catalog.

FAMOUS ORIGINAL ARGUS MODEL A \$10
Now Reduced to

Public acceptance for the original Model A brought such a large volume of sales that substantial savings in manufacturing costs resulted. These savings are now made available to you in the lowest price at which an accurate, precision-built miniature camera has ever been offered. Certified f/4.5 triple Anastigmat lens, 1/25 to 1/200 sec. shutter speeds. Uses 35 mm movie film . . . 18 or 36 exposures to one loading.



INTERNATIONAL RESEARCH CORPORATION

279 Fourth Street, Ann Arbor, Mich.

March 1939

Download this book for free at <http://www.TheArgusA.com/>

4 Parts Of The Camera

The parts of the Argus A family of cameras are very similar to one another; often only one part differs between separate models. In the figures below, the parts of the camera are labeled. If the part is only present on certain models, those models are written in *italics* after the name of the part or figure.

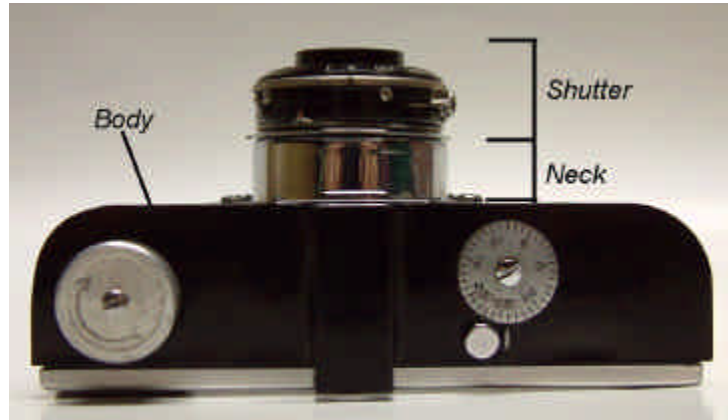

Fig 4-1: Main parts of an Argus A Camera

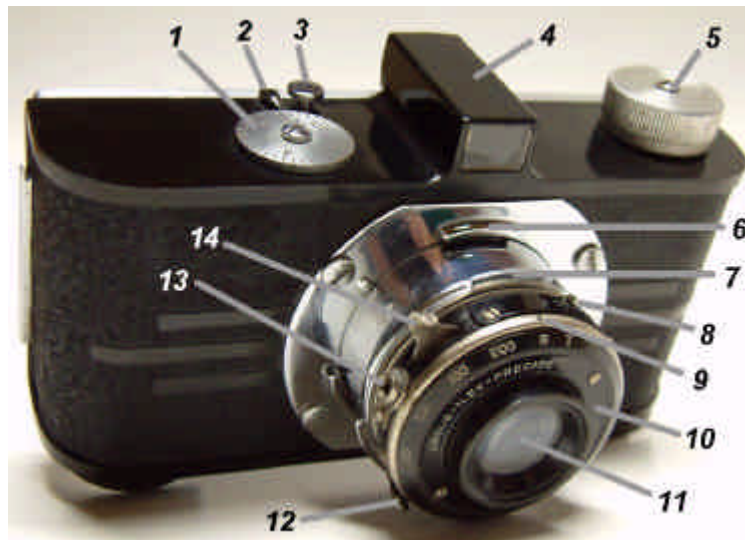
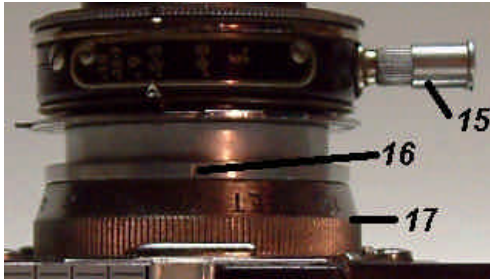

Fig. 4-2: Front view of an Argus A

- | | | | |
|----|------------------------|-----|--|
| 1: | Counter Dial | 8: | Aperture Indicator (<i>A, AF, A2Bs, & A2F</i>) |
| 2: | Counter Dial Indicator | 9: | Shutter Speed Indicator |
| 3: | Counter Dial Release | 10: | Face Plate |
| 4: | View Finder | 11: | Lens Assembly |
| 5: | Winding Knob | 12: | Aperture Lever |
| 6: | Locking Lug | 13: | Cable Release Socket |
| 7: | Lens Locking Tab | 14: | Trigger (<i>A, AF, AA, post-war A2B, & FA</i>) |

Download this book for free at <http://www.TheArgusA.com/>



- 15: Shutter Plunger (*pre-war A2B & A2F*)
- 16: Focus Indicator (*AF & A2F*)
- 17: Focusing Ring (*AF & A2F*)

Fig. 4-3: Neck area of an Argus A2F

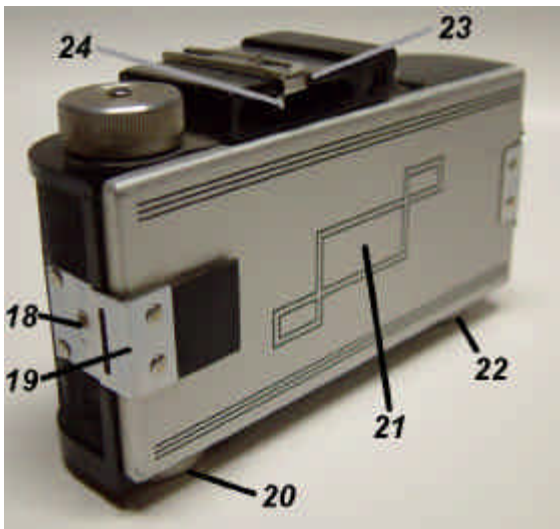

- 18: Lock Clip
- 19: Lock Catch
- 20: Tripod Socket
- 21: Back Cover
- 22: Rewind Knob
- 23: Extinction Meter (*A2Bs & A2F*)
- 24: Brightness Pointer (*A2Bs & A2F*)

Fig. 4-4: Back view of an Argus A2F

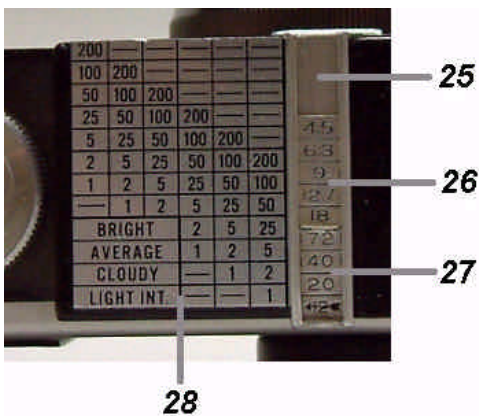

- 25: Slide
- 26: Aperture Tab
- 27: Film Speed Tab
- 28: Shutter Speed Plate

Fig. 4-5: Top view of Exposure Meter/Calculator (*A2Bs & A2F*)



- 29: Sprocket Wheel(s)
- 30: Winding Shaft

Fig. 4-6: Inside view of an Argus A2F

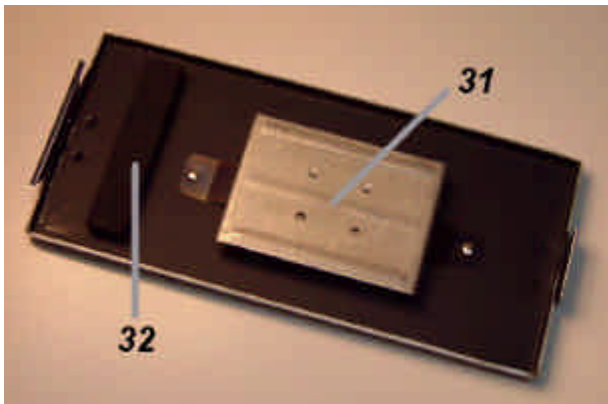

- 31: Floating Pressure Plate
- 32: Film Cartridge Retainer

Fig. 4-7: Inside view of the Back Cover



- 33: Flash Synch Tubes for Argus AA
- 34: Flash Synch Tubes for Argus FA

Fig. 4-8: Flash Synch Tubes

5 User's Guide

Loading The Camera

1. Remove the Back Cover by pressing the Lock Clip. While pressing, either pull on the leather tab on the Lock Catch or pry the Back Cover off with your fingers. If you have difficulty removing the Back Cover, you can pry the Lock Catch with a flat-head screwdriver or butter knife, and later bend the Lock Catch with pliers until it is easier to remove with your fingers.

2. You have the option of setting the Counter Dial now or in Step 8. (It is safer to set the Counter Dial now, because the method described in Step 8 may loosen the screw which holds the assembly together.) Spin the Sprocket Wheel(s) until they stop by running your finger on them from right to left. This should make the Counter Dial spin counter-clockwise. Push the Counter Dial Release towards the View Finder and hold it. Turn the Sprocket Wheel(s) until the Counter Dial spins a quarter of the way around, let go of the Counter Dial Release, and continue to turn the Sprocket Wheel(s) until they stop again. This will make the Counter Dial advance one frame. Continue to do this until the Counter Dial is set to 34, which is two tick marks from 0 and four tick marks from 30 (because the Counter Dial goes up to 36, not 35). The camera is automatically set to 31 or 32 when the film is rewound, so adjusting it to 34 is not as tedious as it sounds and can be done rather quickly.

3. Pull the Rewind Knob on the bottom of the camera as far out as it will go. Insert the film cartridge in the right side compartment with the knob on the film cartridge facing up. Then lock the film cartridge in place by pushing in the Rewind Knob and turning it until the shaft is fully engaged in the film cartridge. If done correctly, the Rewind Knob should lay flat against the body of the camera as if there were no film inside.

4. Pull the strip of film (the leader) out of the film cartridge and insert it into the slot on the Winding Shaft, so it sticks out about ¼ inch on the other side of the Winding Shaft. Then hold the film snugly along the film track with your fingers and turn the Winding Knob clockwise until the end of the film is bent where it enters the Winding Shaft.

5. Take up any slack in the film by turning the Rewind Knob clockwise. Make certain that the spikes of the Sprocket Wheel(s) line up with the perforations in the film and that the film lies flat and straight.



Fig 5-1: Loading the camera

6. Replace the Back Cover by hooking it onto the right side of the camera and closing it onto the Lock Clip. While closing the camera, ensure that the foam Film Cartridge Retainer on the Back Cover presses down on the lip of the film cartridge.

CAUTION: If the Back Cover does not go down easily, do not force it. Remove it and restart the loading process.

7. You must now wind the portion of the film that has been exposed to daylight. This is done by advancing the film **twice**.

Advancing The Film: Look at the Counter Dial and remember the number of the current exposure. Push the Counter Dial Release towards the View Finder and hold it there. Turn the Winding Knob until the Counter Dial spins about a quarter of the way around, then let go of the Counter Dial Release. Continue to turn the Winding Knob until it nears the number of the next exposure, then slow down until you feel the Winding Knob stiffen. Do this gently or you will rip out the perforations on the film and possibly ruin your pictures. The Counter Dial should be set to the next number and an unexposed portion of the film will be in position ready to take a picture.

8. If you set the Counter Dial in Step 2, then the Exposure Counter should be set to “0”. If not, set the Counter Dial to “0” by turning it counter-clockwise. Be careful not to loosen the Counter Dial screw as you turn it.

9. You are now ready to take a picture.

Taking Pictures

10. If the Shutter and Neck assembly is in the storage position and locked away, rotate the assembly until it unlocks and springs forward. The storage position, with the Lens Locking Tabs secured into the Locking Lugs, cannot be used to take pictures. In order to take a photograph, the Neck must be extended as in Fig. 4-1.



Fig 5-2: The Neck and Shutter in the storage position (left), and the extended position (right)

11. The method for focusing the lens depends on the model of camera:

Argus A, A2B, and FA (Two-Position Focus): This is probably the most misunderstood aspect of the Argus. The focus distances are only labeled on the Argus

Download this book for free at <http://www.TheArgusA.com/>

FA. (The Modified Two-Position Focus in Chapter 8 discusses the two-position focus further.)

1. Focus in infinity position: To focus for a distance of about 15ft. to Infinity, rotate the Shutter and Neck assembly until the Lens Locking Tabs are NOT over the Locking Lugs. If done correctly, the Shutter and Neck assembly should turn freely and not be “snapped” into place.

2. Focus in close-up position: To focus for a distance of 6ft. to about 15 ft., turn the Shutter and Neck assembly until it locks stiffly against rotation. This allows the lens to come forward slightly and should place the Lens Locking Tabs directly over the Locking Lugs.

Argus AF and A2F (Variable Focus): Rotate the Focusing Ring around the Neck of the camera until the distance in feet is aligned with the Focus Indicator. As you turn the Focusing Ring the Shutter should move either in or out of the Neck.

Argus AA (Fixed Focus): Ensure that you are at least 6 ft. from the subject you are photographing.

12. The method used to set the shutter speed depends on which camera you have. On most models, the speed of the shutter is set by rotating the Face Plate until the speed wanted is aligned with the Shutter Speed Indicator. On post-war A2Bs and all FAs, there is a small lever that points to the desired speed. “25” means 1/25th of a second, “100” means 1/100th of a second, etc. “T” is for timed exposure; the shutter opens when the Trigger is pressed and remains open until the Trigger is pressed a second time. When set at “B” (for Bulb) the shutter remains open as long as the Trigger is held down and closes upon release. When either “T” or “B” are used the camera should be held on a tripod or held firmly on a perfectly stationary object. The Argus AA has only two speed settings: “Time” and “Inst.” “Time” opens the shutter as long as the Trigger is held down like the “B” speed, not like the “T” speed. “Inst.”, meaning instantaneous, opens the shutter for approximately 1/50th of a second.

13. The aperture is set by moving the Aperture Lever, which either points to the aperture setting itself or moves the Aperture Indicator to designate the various f-stops.

CAUTION: Always check the aperture before taking a picture. This setting has a tendency to change when the photographer is not looking.

14. If you are using an Argus AA or FA with a flash gun, ensure that it is properly attached to the camera and has a fresh bulb. The specifications for various flash distances, apertures, and shutters speeds depend on the type of bulb and film, so ensure that these requirements are all satisfied. The required information is often located on the camera’s or bulb’s exposure guide.

15. To take the picture, aim the camera by looking through the View Finder and snap the picture by pressing the Trigger. Most cameras have a Trigger, but some (A2Fs and pre-war A2Bs) have only a Shutter Plunger screwed into the Cable Release Port to fire the

shutter. Keep in mind that the Argus View Finder shows slightly less than will appear on the film negative; this was intentional and meant to compensate for aiming errors. The camera must be held steady, resting against the cheek, and the pressure on the Trigger should be gradual so that the camera is held as still as possible while the shutter is operating. The secret of clear, sharp negatives with a “miniature” camera is firm holding and steady shutter release. This is especially true when using shutter speeds of 1/50th of a second and slower. To avoid the possibility of tremor and when light conditions warrant, it is always advisable to use the highest possible shutter speed.

16. ADVANCE THE FILM IMMEDIATELY AFTER EACH EXPOSURE! The instructions for this are located in Step 7. This is necessary to prevent either double exposures or wasted film. The only way to avoid problems is to get into the habit of advancing the film immediately after taking the picture.

Rewinding Finished Film

17. Ensure that when you are getting close to the end of the roll, you don't tear the end of the film out of the film cartridge while winding it. After 36 exposures, or whatever number of exposures provided by the film, rewind it back into the film cartridge by turning the Rewind Knob in the direction indicated. Make certain that as you rewind the film, you do not prevent the Winding Knob or the Counter Dial from turning. If the camera seems to be rewinding only one frame at a time, push the Counter Dial Release towards the View Finder while rewinding.

18. Remove the Back Cover of the camera and pull the Rewind Knob on the bottom of the camera as far out as it will go. Remove the film cartridge and replace the Back Cover.

Using The Sunny/16 Rule

The best indicator of acceptable shutter speed/aperture settings is a light meter. If you steadfastly refuse to purchase a light meter, or find yourself without one, use the “Sunny/16” Rule.

The “Sunny/16” Rule states: on a sunny day with the aperture set at f/16, your exposure time should be your film speed. For example, if you are using 200 ISO film, you set the Shutter Speed to 200. You should open the aperture one stop if it is hazy, two if it is cloudy, or three if it is in shadow. Close the aperture one stop if you are photographing white sand or snow.

The “Sunny/16” Rule is not terribly accurate, but it works if there is no better way.

Using The Light Meter/Exposure Calculator (A2B and A2F)

I. First, you must set the Tabs to the proper film speed.

Determining Film Speed: To set the Film Speed Tab, you must translate the film speed on the film cartridge, which is in ISO(ASA), to the film speed written on the camera, which is in Weston. Weston ratings are about 80% of ISO ratings; use the chart below to approximate your Weston rating. (If you are using film faster than 100 ISO, set the Film Speed Tab to 100 ISO/72 Weston and you will compensate for it in Step V.)

ISO	Weston
15	12
25	20
50	40
100	72

Table 5-1: Equivalent ISO and Weston film speeds

The Aperture Tab sits on top of the Film Speed Tab, but the two are not permanently attached. Slide the Aperture Tab down onto the Film Speed Tab until your Weston rating is the largest number exposed on the Film Speed Tab. Make sure that this setting does not get changed.

II. Move the Tabs together on the Slide so that the arrow on the bottom of the Film Speed Tab (stamped on top of the number 12) is lined up with the current lighting conditions. Your options are BRIGHT, AVERAGE, CLOUDY, or LIGHT INT (used for lit interiors).

III. Hold the camera with your elbows bent at a 90 degree angle and look through the Extinction Meter. Move the Slide until the Brightness Pointer lines up with the dimmest rectangular window you can see. If you are uncertain of which is dimmest, choose the brighter one.

IV. All of the calculations on the Extinction Meter are now complete. Look at the Shutter Speed Plate number to the left of the Aperture Tab to see which shutter speed should accompany which f-stop. The following two examples demonstrate the use of this system. (On later A2Bs, the top shutter speed is not 200, but 150. Use whichever number is on your Extinction Meter.)



Fig. 5-3 : Example 1

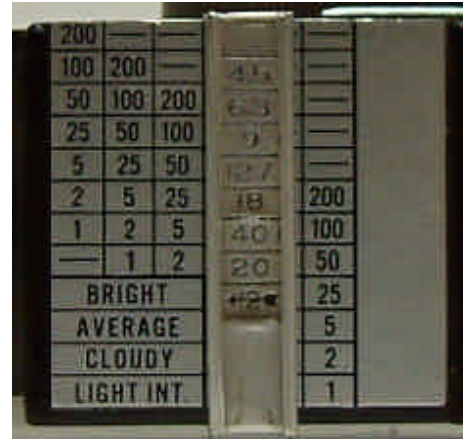

Fig. 5-4: Example 2

Example 1 Film: 100 ISO (72 Weston)
 The second block is visible in the extinction meter.
 You are outdoors with average lighting conditions.
 Use the following Shutter Speed/Aperture combinations:

Shutter Speed	200	100	50	25
f-stop	f/4.5	f/6.3	f/9	f/12.7

Table 5-2: Equivalent Shutter Speed/Aperture combinations for Example 1

Example 2 Film: 50 ISO (40 Weston)
 The third block is visible in the extinction meter.
 You are outdoors with bright lighting conditions.
 Use the following Shutter Speed/Aperture combinations:

Shutter Speed	200	100	50	25
f-stop	f/6.3	f/9	f/12.7	f/18

Table 5-3: Equivalent Shutter Speed/Aperture combinations for Example 2

V. If you are using film that is faster than 100 ISO (200 ISO, 400 ISO, etc.), you must use the shutter speeds above the one next to your desired f-stop. Each time the speed of the film is doubled (100 to 200, 200 to 400, etc), you must use one shutter speed faster. For example, assume that you want to use f/18 and the Extinction Meter indicates that you should use a speed of 5 (1/5th of a second). If the film speed is faster than 100 ISO, you should use the speeds above 5 according to the chart below:

Film Speed	Read Shutter Speed from the block:	Shutter Speed
100 ISO	To the left of the f-stop	Use 5
200 ISO	Above the block next to the f-stop	Use 25
400 ISO	Two blocks above the block next to the f-stop	Use 50
800 ISO	Three blocks above the block next to the f-stop	Use 100
1600 ISO	Four blocks above the block next to the f-stop	Use 200

Table 5-4: Example Shutter Speeds for higher film speeds

f-stop Settings And Spacing

In the early models of the Argus camera, the early As and AFs, the aperture settings are listed as f/4.5, 5.6, 8, and 11. This undoubtedly caused confusion because the difference between f/4.5 and f/5.6 is about a half stop, whereas the other differences are full stops. Remember this if you are using such a camera.

Later models switched to an older European method for denoting f-stops. These settings were f/4.5, 6.3, 9, 12.7, 18; all of which are evenly spaced to allow one full stop between them.

This may not have been the only reason for the change, however. Argus had always been plagued by rumors that the lens on the A was slower than the stated f/4.5, and that the shutter speeds were retarded to compensate for this error. To make their camera settings more accurate, the Argus engineers may have retested their lenses and decided that the iris was choking off more light than originally thought. To fix this mistake, they may have relabeled the settings and increased the size of the largest aperture setting.

When the Argus FA was introduced in 1950, the f-stop scale was changed back to f/4.5, 5.6, 8, 11, 16, 22. Again, if using this camera, bear in mind that the difference between f/4.5 and f/5.6 is only half a stop.

In any event, extensive picture taking using all three f-stop scales has produced serviceable results when processed at a 1-hour photo shop.

Holding The Camera Upside Down

When the Argus first appeared in 1936, “candid” camera photography was still a new hobby. As such, people were unused to using cameras that were small and portable, and not immobilized on a tripod. Many amateur photographers shook the camera as they took pictures, got fuzzy prints, and blamed the camera. After all, it couldn’t be their fault!

The Argus corporation, faced with this problem, decided to tell its customers to take pictures with the camera upside-down, with the View Finder at the bottom and the



Fig. 5-5: Holding the camera upside down.
(Taken from an early Argus A manual)

Back Cover of the camera placed firmly against their forehead. This would provide a steadier platform for taking photos. Early instruction manuals for the Argus A show a bowtie-clad man taking a picture with the camera upside down. In addition to this, the woman photographer on the cover of the Argus pamphlet “Aim and Shoot, Argus Candid Camera Photography” is holding her camera upside down. One assumes that this trend was a short-lived one and that Argus quickly rescinded its recommendation, for this camera-holding technique is not mentioned again.

Download this book for free at <http://www.TheArgusA.com/>

6 Accessories

Soon after it entered the market, the Argus was quickly joined by a myriad of accessories. Verschoor envisioned the Argus as part of a system of components that could cheaply create pictures from start to finish. On the enlarger, the camera body and lens were also used to hold the negative and project the image onto the print. This enlarger, a slide projector, and slide mounting kits were all for sale, and were combined with other Argus products to produce the “ARGUSKIT.” This \$50 kit had everything you needed to process film and produce photographs.

Many of these accessories are no longer relevant. However, there are some Argus items which do still expand the camera’s capabilities.

When possible, the original descriptions of the Argus accessories are used. These are in *italics* and include information such as the Argus “code word,” part number, and original price. These “code words,” in parentheses below the part name, are the special names by which Argus referred to its own products, again copying a system that Leica introduced.

Lens Attachments



Fig. 6-1: Argus filters, adapters, and lens shade (left) and Series V adapter (right)

Argus slip-on filters and adapters are among the most useful accessories, but they have some limitations that one should bear in mind. The filters and the sun shade from the Argus Lens Accessory Kit do not fit the AA, the FA, or the post-war A2B. They are stackable, but if more than two are used they begin to crop the edge of the negative. Without modification, the Kodak Series V Adapter Ring only fits the post-war A2B and the FA. Refer to Chapter 8 for ideas on how to reuse filters if they are scratched or have fungus. See also the “New Lens Cap” section later in this chapter.

Lens Shade

(SUNSE)

Part No. S-1

Original Cost 65¢

Eliminates light from rays outside the angle of the lens. Every shot will be improved by the use of this attachment. With it it is possible to shoot almost directly into

Download this book for free at <http://www.TheArgusA.com/>

the sun; thus providing more interesting and more artistic shots. The attachment fits the camera lens mount as well as filters, copying, and portrait attachments. Any combination may be used. This lens shade is very helpful in bright situations.

Portrait Attachment No. 3

(SORCA) Part No. S-2 Original Cost 90¢

Shorten focus and increase size of object. Head and shoulders just about fill negative. Focus in infinity position covers a field of 18 x 27 inches at 40 inches working distance. Focus in close-up position covers a field of 14 x 21 inches at 32 inches working distance. Depth of field, lens wide open (f4.5) is 8 inches. Measure all distances carefully from the front of camera's Body. Center lens with object as view finder cannot be entirely depended upon at these close working distances. Refer to Chapter 8 for more information on taking close-up pictures and the use of this attachment.

Copying Attachment No. 2

(SOPLU) Part No. S-3 Original Cost 90¢

Shortens lens focus and increases size of objects. In infinity setting covers field 10 x 15 inches at working distance of 22½ inches measured from front of camera case. In close-up setting covers field 8 x 12 inches at working distance of 19¼ inches. When working at these close distances center the lens with the object, using ground glass laid on film track instead of regular view finder, which will not read correctly when this attachment is used. Measure distances carefully as Copying Attachment reduces depth of focus. Refer to Chapter 8 for more information on taking close-up pictures, the use of this attachment, and substituting ground glass.

Yellow Filter 2x

(SILSA) Part No. S-4 Original Cost \$1.00

For moderate color correction where high shutter speeds are desirable. Requires double exposure time. Produces improved cloud effects and useful in very bright light, such as marine and sea shore shots. Works as described only for black and white film. Approximates a Wratten #8/K2 filter.

Yellow Filter 4x

(SELRO) Part No. S-5 Original Cost \$1.00

For full color correction. Removes excess of blue-violet light producing popular dark sky and cloud effects. Requires four times normal exposure. Works as described only for black and white film.

Lens Cap

(SUBSU) Part No. S-6 Original Cost 25¢

Every fine lens deserves constant protection against dirt or scratching. Keep lens cap in position at all times except when making exposure. This cap also protects film against unintentional exposure. Attach with cord to the diaphragm lever through holes provided. Making a new lens cap is described later in this chapter.

Lens Accessory Case

(SARCI) Part No. S-7 Original Cost \$1.00

These do not age well. If found in good condition, do not use in order to preserve its historical value.

Lens Accessory Kit

(SOMTA) Part No. S-8 Original Cost \$5.00

Complete Kit of the above seven items in case for Model A.

Lens Accessory Kit for Argus AF

(SAFFO) Part No. SAF-8 Original Cost \$5.00

Complete Kit for Model AF only. (Same as the standard Lens Accessory Kit but without the portrait and copy lenses but including the red filter and safety screw instead.)

Red Filter

(FILRED) Part No. S-9 Original Cost \$1.50

The red filter excludes practically all the color spectrum except red, thus reducing haze in aerial and distant landscape shots to a minimum. It lends a decided dramatic quality to many types of scenes and gives the much desired dark sky effect with panchromatic film. It is absolutely necessary that the red filter be used with infra-red film. Interesting moonlight effects in daylight shots can then be obtained. Use of red filter requires five times normal exposure time with either panchromatic or infra-red film. This filter cannot be used with orthochromatic or other non-red sensitive films. Approximates a Wratten #25/Wratten A filter.

Kodak Series V Adapter Ring 15/16in - 23.5mm

This adapter allows the use of Series V filters with the post-war A2B and the Argus FA. The variety of Series V filters, for both color and black and white use, makes this a particularly useful accessory. This filter holder can be adapted for use with pre-war Argus cameras by modifying an old Argus filter, as described in Chapter 8, or by bending the aluminum tabs until they properly grip the Lens Assembly.

Carrying Cases

Carrying cases for the Argus A cameras are commonly found in very poor condition because they are made out of leather and about sixty years old. The author has seen examples of cases for every camera except the Argus FA. Cases with oval fronts are for use with the pre-war A2B and the A2F, which have the bulky Shutter Plunger, and some cases have holes for the Flash Synch Tubes on the Argus AA. In general, if a case is found in good condition, it should not be used.

Remember that the Shutter and Neck should be in the storage position when the camera case is closed.



Fig. 6-2: Argus Redycase (left), De Luxe Case (center), and Zipper Case (right)

Black Leather Zipper Case

(BLANCA) Part No. 50 Original Cost \$2.50

An all-purpose case of heavy selected cowhide, completely lined with soft rich velvet that will not scratch or damage camera. Zipper fastener running around slightly more than three sides, allowing almost instant full (bookwise) opening. Swivel snap loop can be quickly attached to belt—used with shoulder strap or turned around out of the way for easy pocket access. Net weight of case is 3 ounces and gross shipping weight 5 ounces. A practical user's case because it is more durable than the other cases and is as distinct as the camera. Though rarer than the De Luxe or Redycase, these are often seen in better condition because of the tougher leather and durable design. This case is also seen in brown.

Soft Suede Zipper Bag

(SWACA) Part No. 50A Original Cost \$1.00

These are apparently rare because the author has never seen one.

De Luxe Black Leather Case

(LUXCA) Part No. 50B Original Cost \$4.50

Superbly tailored in fine selected black leather and completely lined with soft plush velvet. Simple opening of one snap fastener instantly drops entire front for action, exposing lens assembly, finder, winding knob and counter. Case is sufficiently flexible to even allow closing with lens barrel ever ready at infinity focus. Has hole in bottom for tripod mounting or safety screw plug. Fitted with full 52" shoulder strap with ample length buckle adjustment. Net weight of case is 6 ounces. Shipping weight is 8 ounces. Often damaged at straps and bends in the leather. Though relatively common, these cases are harder to find in good condition. These cases are often seen in brown. These comments apply to the case listed below as well.

Black Cowhide "Redycase"

(REDCA) Part No. 50C Original Cost \$2.50

This new carrying case affords perfect protection for your Argus and is always ready for instant action without removal of camera. Is rich in appearance and most practical for quick shots. Made of genuine hand finished deep grained cowhide and fitted with black leather neck strap. Net weight of case is 6½ ounces. See the comments about the case listed above.

Carrying Case Safety Screw

(SAFE) Part No. X-3 Original Cost 30¢

Now available for use in anchoring the Argus camera with greater safety in either the De Luxe Carrying case or the "Redycase". This is a threaded stud with large knurled head which can be inserted in tripod socket to prevent the possibility of camera accidentally falling out of case. These are common to all cameras which have a tripod socket and fit into a case.

Other Accessories



Fig. 6-3: (From left to right) Two light meters, two cable releases, a tripod, and a self-timer.

Besides the standard Argus accessories described above, there are several other pieces of equipment that help make the Argus more flexible and fun.

Light Meter

This is not so much an accessory as a necessity. Light meters help the photographer to select the proper aperture and shutter speed for the picture. There are many types of light meters, and they range in price and quality. Even a cheap model, however, will get be accurate enough to produce a serviceable picture.

The Extinction Meter on the A2Bs and A2F, for example, relies on the eye's interpretation of darkness and the photographer's decision of what is BRIGHT or

AVERAGE or CLOUDY, etc. These are notoriously inaccurate factors to deal with. Still, the meter works well enough to produce a decent photograph.

Vintage Book On Photography

One great way to get into the mindset of using an antique camera is to read photographic books from the camera's time period. In addition to being full of great period pictures, they offer great tips and techniques that were popular at the time.

There were several books written in the 1950s about Argus cameras, but the author has only found one which mentions any of the Argus A line. The earliest editions of "The Argus 35mm Guide", by Dr. Kenneth Tydings, S.P.E., lightly touch upon the Argus FA. The majority of the book is spent discussing the more popular Argus cameras, such as the C-3 and C-4, and the "Safe-Set" formula devised by Dr. Tydings.

The best vintage photography book is the "How To Make Good Pictures" series of books by the good people at Kodak. In order to educate the public about photography (and to advertise Kodak's fine products), this book was widely printed and distributed at a low price. The earliest editions were printed in the 1920s or 30s, and an updated version was still being published, under the same title, in the 1990s. While it only discusses Kodak products, "How To Make Good Pictures" talks about all aspects of photography at the time of publication, like yellow filters for black and white film, red filters for infrared films, techniques like silhouetting, etc. Copies of this plentiful book can be easily found at photographic shows/swap meets, used book dealers, flea markets, and eBay. They don't cost 50¢ anymore, but you can easily get them for under \$10.

Cable Release

This is a relatively simple invention that allows you to fire the without disturbing the camera. One end gets screwed into the aptly-named Cable Release Socket, and the other end has a button on it. Press the button and the shutter fires.

Use a cable release when taking pictures from a tripod.

Small Tripod

They're small and cheap. Most cost between ten dollars and thirty dollars, and are available at almost any camera shop. They are particularly helpful because they are unobtrusive and can fit into a pocket.

Beware of the truly cheap models because they are really junk. Ask to see one before you buy it, and try to get the most stable one you can find. This is one place where spending a few extra dollars won't hurt.

Mechanical Self-Timer

These were small mechanical self-timers used in the 1950s and 60s, which could be attached to the end of a Cable Release or screwed directly into the Cable Release Port. Once attached to the camera, they would wait a certain amount of time and then take a picture. Common brands include Kodak, Haka (AutoKnips), and Kopil.

Some timers even allow you to take timed exposures when the camera speed is set to "B"; up to a second or two. It is difficult to set the exposure time precisely, however, because you have to make successive adjustments to the timer settings until you are close

to the desired length of time. Self-timers are particularly useful if you are using a cheap, unstable, miniature tripod or taking extreme close-ups.

There are several things to keep in mind if you are looking for a self-timer. Try to get one with an instruction manual. These are useful in learning all of the settings of your timer and taking advantage of all of its features. Timers are often also in need of lubrication. Try to buy one that is still working well. To lubricate a self-timer, either take it to a camera repair shop or try it yourself by applying the method for lubricating shutters described in Chapter 7.

New Lens Cap

You need a lens cap or your lens will get dirty and scratched. Even casual dust will lower the quality of your photograph. Lens caps also prevent accidental exposures. Follow the instructions below to make a lens cap.

If you have a slip-on filter that is damaged or unnecessary, you can paint the outside of the filter surface flat black. This is the easiest method to make a lens cap, but it is rather wasteful.

Another lens cap can be made out of items commonly available at a hardware store: a plastic leg-tip, a razor, and some duct tape. A plastic leg-tip is a cup that fits on the bottom of the leg of a chair and prevents the chair from scratching up the floor. Make sure you purchase a plastic one, not a rubber one, and try to find a black one so that it matches the color of the Body. Use a leg-tip with a diameter of 1 inch unless you are making a lens cap for the AA, in which case you should use a diameter of 7/8ths of an inch.



Fig. 6-4: A Lens Cap in various stages of production.

Use the razor to trim the edge of the leg-tip until it is about 3/8ths of an inch tall. The depth of the “cup” should now be slightly more than the height of the lens mount and should be able to cover it loosely. Cut a strip of duct tape so that it will be slightly wider than the inside edge of the cup. Wrap this tape along the inside edge of the leg-tip, going around four or five times. Push the tape so that it stick directly to the inside edge of the leg-tip; cut it with a razor if it “bubbles” away from the wall. Trim the duct tape that is sticking out of the cup with the razor.

The inside of the leg-tip should now be too small to fit the lens mount. If the lens mount still fits inside, add more duct tape until its too tight. Now unwrap the tape one

quarter of the way around the inside rim and cut it off. Try to fit it on the lens mount. Continue this process of unwrapping and trying until the lens cap fits snugly. Use the razor to trim the excess plastic and tape, and admire your new lens cap! If making a lens cap for the pre-war Argus A2B and A2F, make small notches in the lens cap to accommodate the screws in the face plate.

Hand-Held Or Accessory-Shoe Mounted Rangefinder

These devices measure the distance between the camera and the object being photographed. They are used to ensure that your subject appears in focus. While they were popular from the 30's to the 50's, SLR cameras and cameras with coupled rangefinders made them unnecessary.

Rangefinders are more practical on the Argus AF and A2F with their variable focus. Companies that manufactured rangefinders for accessory shoes include Watameter, Telex, Hugo Meyer, Rainbow, Waltz, and Ideal. They often had a clip which sat in a camera's accessory shoe.

Flash Guns

The main selling point of the Argus AA and FA was their ability to use flash. While this does not seem fantastic to us now, it was revolutionary at the time of the introduction of the AA. The flashbulb had only been invented a few years earlier; many photographers still used dirty and dangerous flash powder. Candid indoor pictures, night shots, and flash fill photography all suddenly became possible with the introduction of flash-synchronized cameras like the Argus AA. At the time, it was a major step for amateur photography.

Unfortunately, flashbulb photography now has several distinct disadvantages. Flashbulbs are no longer widely manufactured, and while they are not rare or even uncommon, they soon will be. Even those that can still be found are aging and becoming less reliable. Flash bulbs require large flash guns and produce much more light than electronic flashes, making them much more intrusive for public use. Like the once-common vacuum tube, the flashbulb belongs to that growing family of self-consuming technologies that will soon join the dinosaurs.

When acquiring a flash for your Argus camera, make certain that you purchase a flash that will fit your camera. The Argus AA uses a flash gun whose flash posts are 3/4ths of an inch apart (center to center). This flash is also used with the Argus C3.

The Argus FA uses a special flash however, that is not compatible with the Argus AA or C3. For a flash to fit the Argus FA, the flash posts must be 1.2 inches apart (center to center).

There is one flash accessory that can be used with any Argus camera. When flashbulbs first became popular, many cameras could not be easily adapted for use with a flash. Several companies tried to capitalize on this by making flash adapters that would screw into a generic Cable Release Socket and synchronize the camera shutter with a flash gun. These adapters can still be found. They do, however, require a bit of fine tuning and this will consume some of your precious supply of flashbulbs.

On a final note, be aware that due to considerable timing differences an electronic flash cannot just be connected to a camera that expects flashbulbs. Modern electronic flashes cannot be used with a flashbulb camera without timing alterations to the camera.

7 Restoration And Repair

One of the great advantages of the Argus A is how easy it is to repair. This chapter will discuss repairs by dividing the camera into three main sections: the Body, the Neck, and the Shutter (see Fig. 4-1).

Inevitably, when talking about camera repair, one runs into the “Q-Tip Question”: Should one use Q-Tips when working on a camera? The problem lies in the fact that tiny hairs from the ends of a Q-Tip will lodge themselves in hidden places and prevent the camera from working properly. Careful inspection is necessary to ensure those hairs are found and removed before reassembly. Your author has carefully used Q-Tips in several camera restoration projects and has never had a problem, but has found plenty of stray hairs along the way. Thus the decision is left to the reader. If one truly has difficulty with this idea, simply replace the word “Q-Tip” with “toothpick with a tiny cloth tied around the end”.

The repairs mentioned in this chapter are intended to be repairs that a reasonable person with no/minimal experience can accomplish. If there is any doubt as to whether you can complete these tasks, take your Argus to a local camera shop for repair.

Safety first! Common sense will protect you from most danger, so use it. If you use any flammable fluid, you must ensure that there is no source of flame present and that the area is well ventilated. When disassembling a shutter, wear eye protection to prevent loose springs from flying out and damaging your eyes.

The Camera Body

The Body is largely a piece of bakelite and cleaning it is relatively simple. Almost all dirt can be removed by scrubbing it with a dampened toothbrush. Before using chemicals or cleaning fluids to remove dirt from the Body, test them on a small, hidden part of the camera first. Keep in mind that some chemicals are known to damage some varieties of bakelite.

Be sure to clean the inside of the camera for dust, which may settle on the negative and ruin photographs. Bakelite has a tendency to attract dust, so be diligent.

Film Transport Mechanism

Unfortunately, the workings of the film transport mechanism are covered by a metal block that is glued into place. This makes repairs very difficult. If faced with such a problem, consider acquiring another camera.

The Sprocket Wheels, the shaft they spin on, and the Winding Shaft are often corroded. This doesn't affect the operation of the camera unless the corrosion is flaking off, in which case you must remove the loose corrosion with a damp rag.

Film Advance Knob

The Film Advance Knob is one of the simplest parts of the camera, and has seen no significant change throughout its 15 year life. It is made of aluminum and is attached to the main body of the camera by a simple screw.

The only reason to take it off is to clean around it or to polish it with aluminum polish. If you attempt to polish it, be prepared to spend a lot of time scrubbing the knurled portion. Ensure that when you replace the knob, the slot in the screw-hole of the knob is properly lined-up.

View Finder

The View Finder is one of the trickier parts of the Body. It consists of two lenses, a round one and rectangular one, on either side of the View Finder. If at all possible, try to avoid disassembling the viewfinder, because both lenses can be easily damaged or replaced incorrectly so as to get lost later. Be careful not to use too much cleaning solution when wiping the viewfinder lenses, because the fluid may leak to the other side of the lens.

In the earliest models, perhaps the first twenty thousand Argus As, the rear lens of the View Finder (the one closest to the eye), is secured by two bakelite tabs. These tabs are a part of the Body of the camera and wrap around the bottom of the lens to keep it in place. This makes removing the lens risky business, because the tabs must be spread apart and may break, making the View Finder useless. One should only attempt this if one accepts the risks involved.

In other early models like the early As and the AFs, the rear lens is held in place by a thin metallic band. This metallic band is glued in place and can only be removed by breaking it up into various pieces. This is a tricky thing to attempt, and one stands a good chance of damaging the lens while trying to pry out that stubborn band.

In the later As, A2Bs, A2Fs, AAs and FAs, the rear viewer lens is retained by a ring, which is easily pried out and replaced, allowing easy access to both View Finder lenses and the inside of the viewfinder. Still, be careful not to chip the glass.

The front lens of the View Finder on earlier models is held in by either a tiny bit of glue or a very tight fit. Only on later models is there a rectangular “ring” which follows the perimeter of the lens and keeps it from slipping out. Do not try to pry the lens out through the front of the camera. It is best to remove the rear lens and push the forward lens out with a Q-Tip. When replacing a lens without a retaining ring, apply a TINY bit of glue around the edge of the lens with a razor to keep it in place. Before permanently replacing both lenses, look through the viewfinder to confirm that everything looks right.

The rear lens retaining ring is the same as the rear lens retaining ring for the rangefinder and viewfinder of the Argus C, C2, and early C3s. In addition, these cameras all share the same rear viewfinder lens, although the rangefinder lens is different. Keep this in mind as a source of spare parts if you lose the ring or damage the lens.

Counter Dial

The Counter Dial is relatively simple to disassemble, but there is not much that can be done to repair it except replacing the parts from another camera. Just remove the retaining screw and pull the parts out.

Underneath the main Dial with the lines and numbers, there are two other items that spin with the screw. The first is a copper disc which is slightly indented like a bowl. Sometimes the disc has slits in it and sometimes there are multiple discs. There is also a copper or brass cylinder. These pieces are supposed to work like a clutch to allow you to

set the Counter Dial to “0” when the camera is first loaded with film. Unfortunately, this clutch often fails and begins to unscrew the retaining screw.

When reassembling, ensure that these items are replaced onto the screw in the proper order; first the Dial, then the copper discs (with the “rim” of the bowl touching the Dial), and then the brass cylinder. This mechanism screws into the center of a gear of the film transport system and this gear must be held in place while screwing the Counter Dial mechanism back in. The Counter Dial gear is located directly behind the gear attached to the Sprocket Wheels. Use a pencil or screwdriver to keep the Counter Dial gear from moving during reassembly. When properly installed, the Counter Dial gear is perfectly aligned with the Sprocket Wheel gear. Do not overtighten the screw, or it will prevent the Counter Dial and film transport system from working properly. If, after reassembly, there are film transport problems that did not exist before, check the alignment of the Counter Dial gear first.

Sprocket Wheels

The Sprocket Wheels are an integral part of the film transport system. Most of the system is hidden behind a glued block under the serial number and above the Sprocket Wheels.

Occasionally, a Sprocket Wheel will loosen on its shaft and spin freely. Glue it back into place with epoxy, but ensure that the sprockets from the top wheel and the bottom wheel are aligned.

Back Cover

The Back Cover is relatively simple. It is completely interchangeable between all of the various models.

On the inside of the Back Cover, the entire surface should be flat black. Some earlier versions have a felt-like texture that was glued on, but more commonly one sees just paint. In either case, worn or scratched areas can be touched up with flat black model paint.

The Lock Catch may have to be bent in order to get it to tighten or loosen its grip on the back of the camera. Making sure that the Back Cover removes easily but stays in place is crucial, because the worst thing that can happen in the middle of a roll of film is having the back of the camera pop off. Bend the Lock Catch with a pair of pliers, but first wrap them in some tape to ensure that the pliers don't leave any “tooth marks” on the Catch.

If the camera had film left in it for several years, then the foam Film Cartridge Retainer is probably dried out and stiff. You have two options: leave it the way it is or replace it with ½ inch wide weather-stripping from a hardware store. The Film Cartridge Retainer was designed to hold a variety of different type of film cartridges in place, but it is not crucial for the modern 35mm film cartridge. So one can leave it for authenticity or replace it for appearance with little worry about it affecting the operation of the camera.

The Pressure Plate is the greatest change in the evolution of the back cover. All of the pre-war models (A, AF, pre-war A2B, A2F, and AA) have a fixed, black plastic Pressure Plate. If it breaks off, it can be glued back into place with a tiny bit of glue. The Plate must maintain the same height and must be in the same position, so take care to

glue it EXACTLY where it broke off. Serious problems will occur if the Pressure Plate is not affixed correctly.

The post-war A2B and the FA have a floating Pressure Plate (see Fig. 4-7). This is a stamped aluminum plate that is kept aloft with by a springy metal band. The only problem to be had with a floating Pressure Plate is a weak spring, but this can be fixed by carefully bending the metal band with a pair of needle-nose pliers.

Both the fixed and the floating Pressure Plate work well, and one should not assume that using the floating Pressure Plate will produce dramatically superior results.

Extinction Meter

If the Slide is missing, the Extinction Meter is useless. If the Shutter Speed Plate is missing, the Extinction Meter is useless. If the Film Speed Tab or the Aperture Tab is missing, the Extinction Meter is useless.

If the Shutter Speed Plate is loose, it can be glued back on with epoxy.

Occasionally, the tinted, see-through portion of the Extinction Meter, underneath the Shutter Speed Plate, becomes loose. To remove it, use a set of needle-nose pliers to pull the plastic retainer out through the front of the camera. The plastic see-through strip should then fall out. Clean the inside of the housing with a toothpick to remove any dried-out, yellowish glue flakes. Clean and replace the plastic see-through strip, with the lightest section closest to the Winding Knob. Spread some epoxy on the outside of the plastic retainer and the inside of the housing, and push it back into place with needle-nose pliers.

To clean the see-through portion of the Extinction Meter, use a dry Q-Tip from the rear side of the camera. Because the plastic retainer doesn't allow Q-Tips to clean from the front of the camera, use compressed air to get the front side clean.

The Flash Mechanism

Three things can be wrong if a flash mechanism doesn't work: the camera isn't working, flash gun isn't working, or both.

To test the flash gun, install batteries and a good flashbulb and connect the two flash posts with a wire. When the connection is made, the flashbulb should fire. If it doesn't fire, the problem lies with the flash gun. Often, a flash gun will seem broken because the electrical contacts are dirty. Clean these contacts with steel wool or fine sandpaper. Be certain to clean the flash synch tubes on the camera, the flash posts on the flash gun, and any other contacts the flash gun may have, such as battery terminals. This is the primary cause of "broken" flash guns.

To test the camera, you will need an electronic multi-meter or some other device that measures electric resistance. Attach the two probes of the multi-meter to the two Flash Synch Tubes. If testing an Argus AA, set the shutter speed to "Time". If testing an Argus FA, set the shutter speed to "B". Press and hold the Trigger while watching the multi-meter. If the camera is working correctly, the multi-meter will indicate that there is little or no resistance as long as the Trigger is held. If the flash mechanism is damaged, the multi-meter will display infinite resistance. To repair a damaged camera, the break in the camera's flash circuit must be found. Since the flash circuit is just a switch, finding the break is not difficult. But it does involve disassembling the camera to some degree.

Light-Proof Ribbon

The most overlooked part of the Body is the inside of the cylinder that the Neck slides into. If you undo the four screws that hold the Neck and Shutter assembly to the Body, you should see that the inside of this Body cavity is lined with a fuzzy, light-proof ribbon that is similar to velvet. Some cameras do not have this ribbon because it loosened over time and was removed by a previous owner. On some cameras the ribbon loosened but slides up and down with the Neck, so it still keeps the light out. On yet other cameras, the ribbon is glued to the sliding portion of the Neck. This fuzzy ribbon is absolutely necessary to prevent stray light from ruining your film.

If the ribbon has come loose but is still inside to the camera, it must be glued back into position. Clean out the cylinder and glue the ribbon along the inside edge. Contact cement works well as a glue. Start the edge of the ribbon flush with the front of the Body. This will leave about a quarter of an inch at the bottom uncovered. This portion, closest to the film, is where the Neck spring rotates, and ribbon will hinder this rotation.

If the original ribbon is missing, you must replace it with some sort of modern material. The only stipulations are that the substitute must be dark, not shed tiny hairs, and be about 1/32 of an inch thick. Felt and other materials that release tiny threads are unsuitable because the threads will fall on the negative and ruin it. Double-knit polyester, easily found in thrift store clothes, works well. Fig. 7-1 shows the dimensions of the light-proof ribbon.

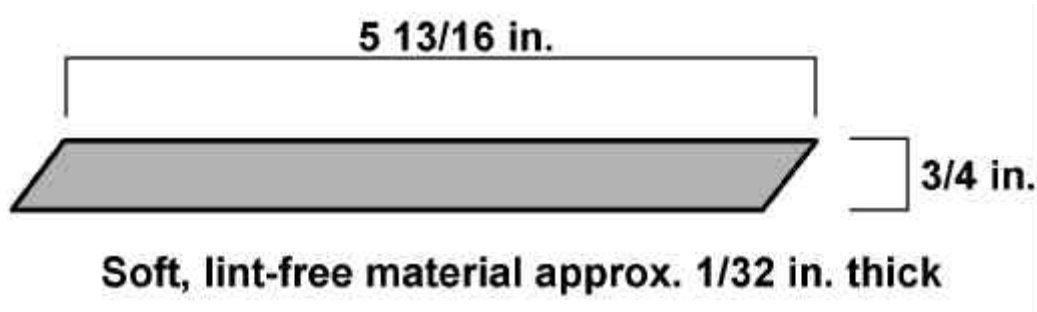

Fig. 7-1: Dimensions of light-proof ribbon in the Body cavity

Be careful not to pry off the light-proof tape when you are replacing the Neck.

The Neck

There are three types of Necks: the two-position focus (A & A2B), the variable focus (AF & A2F), and the one you can't fix (AA & FA). All three are removed from the Body by unscrewing the four retaining screws on the front of the camera. All three should be painted flat black on the inside, and any scratches should be painted over.

The Neck You Can't Fix

The easiest Neck to deal with is the one you can't fix. The Argus AA has no Neck because the shutter was redesigned to be immobile. The Neck of the FA is a variation of the two-position focus that cannot be removed without cutting the flash lead wires. In theory, it is similar to the two-position focus, but it incorporates the flash mechanism in a way that makes it very difficult to remove and disassemble.

The Two-Position Focus Neck

The two-position focus Neck is just a tube. Clean the outside of it if you disassemble the camera.

The Variable Focus Neck

If the variable focus Neck is difficult to rotate, it can be easily loosened. Most often, the grease used to lubricate the mechanism has just thickened with time. Rotate the Focusing Ring far enough so that you can see the three lubrication grooves on the inside of the Neck. They are about one tenth of an inch wide and run parallel to the direction of the Neck. Tear the “fuzz” off of one end of a Q-Tip and dip the stick in lighter fluid. When you pull it out, the Q-Tip will be wet with lighter fluid, probably less than a drop. Touch the Q-Tip to the lubrication groove and the lighter fluid will flow from the stick to the inside of the focusing mechanism. Repeat this procedure for the other two lubrication grooves. Rotate the Focusing Ring to spread the lubricant until it feels very loose. Set it aside and allow it to dry for a day or so. If it is still to difficult to rotate after it dries, repeat this procedure.

The variable focus Neck also has an extra spring and interior light shield. Do not forget to replace these when the you reassemble the camera.

Separating The Neck From The Shutter

The Shutter is bolted to the Neck by a threaded cylinder that surrounds the rear-most lens of the Shutter. The nut that screws onto the cylinder is a flat disk with two grooves on opposite sides of the disk. If one removes the Back Cover of the camera and looks at the disk surrounding the lens, these two grooves are plainly visible.

The dimensions of the nut and the grooves vary from model to model. Normally, specially measured U-shaped wrenches are used to grip the nut and unscrew it. There are also adjustable spanners, which can fit a wide variety of sizes.

Ed Romney (www.edromney.com or (864)597-1882) sells a tool that works particularly well for the Argus. His “AOS Optical Spanner”, with pointed ends, fits every model of Argus A type camera. The part number is “AOS-PT” and it sells for \$19.00, not including shipping or taxes. S.K. Grimes (www.skgrimes.com or (401)762-0857) also sells an Optical Spanner Wrench, which runs \$35.00, including postage to the U.S.A., for the pointed version.

As is almost always the case, there is a cheaper alternative. You can make your own “homemade” adjustable shutter removal tool. It won’t work as well as a custom U-shaped wrench, but it is enough to get the job done. It is made by adapting a drawing compass to the task. This compass is the kind that is used to draw circles, not the one used to find magnetic North. You must purchase the kind of compass that holds its own lead, not the type that holds the whole pencil. Remove the lead from one tip and the metal spike, used to mark the center of a circle, from the other. Replace these with stiff metal wire that will protrude approximately 3/4ths of an inch from the two tips of the compass legs. The best source for this stiff metal wire is a metal coat hanger cut into sections with wire cutters. Pound one end of each wire section partially flat; a hammer pounding against concrete will do the trick. This flat end will grip the two grooves on the nut so that you can unscrew it. This tool now serves as a U-shaped wrench that can be adjusted fit every model of Argus A camera.

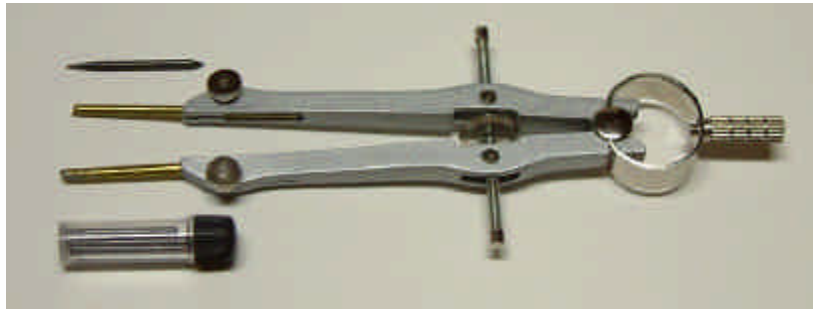

Fig. 7-2: "Homemade" adjustable shutter removal tool

Once you have removed the nut, the Shutter can be separated from the Neck, and two metal plates, one with the Lens Locking Tabs and one with the Locking Lugs, can be removed from the Neck. In addition to these plates, there are occasionally one or more thin washers. These washers are the last to come off of the shutter during disassembly. These were probably put in place to ensure that the camera was in perfect focus, despite any minor differences between parts. Keep these brass washers with the Shutter they were found on.

If you intend to switch Shutters between two different models, like the A and the AF, you may also need to switch the nuts that retain the shutters so that they will fit in the different Neck.



Fig. 7-3: Two separated Neck and Shutter assemblies; AF (top) and post-war A2B (bottom)

Fig. 7-2 shows two Neck and Shutter assemblies separated; an Argus AF is on the top and a post-war Argus A2B is on the bottom. The parts are laid out from left to right: the Neck, the plate with the Locking Lugs, the plate with the Lens Locking Tabs, the retaining nut, the spacing washer (only on the AF), and the Shutter. As you can see, the assemblies are very similar. Only the retaining nut for the two models is different.

As you reassemble the Neck and Shutter, ensure that the alignment holes on the various components line up with the alignment pin on the Shutter.

The Shutter

Cleaning The Lens

The objective lens of the Argus is very easy to clean. But be careful not to scratch or damage the lens by using improper cleaning techniques. At a minimum, use only the materials found in a lens cleaning kit purchased from a camera store.

The Lens Assembly, which has already been removed, can be further disassembled. The rear lens of the assembly is held on by a screwed-on retainer. If you need to clean the inside surfaces of these two lenses, unscrew the retainer. Be careful to replace the rear lens with the “right-side up”, otherwise your camera may suffer from spherical aberration.

The Argus objective lens is a triplet lens system and is composed of three separate lenses. The lens that is closest to the objective and furthest from the film is the one that gets the dirtiest. For the purpose of discussion, this lens will be called the Outside Lens. The lens that is visible when you remove the Rear Cover and look inside the Neck will be called the Inside Lens. The third lens, which is hidden from the camera user, will be called the Middle Lens. Light, traveling from the subject of a photograph to the film, first passes through the Outside Lens, then the Middle Lens, then the Inside Lens before reaching the negative.

First clean the exposed surface of the Outside Lens and the exposed lens surface of the Inside Lens.

If there is visible dirt between the lenses, unscrew the Lens Assembly. This allows you access to one surface of the Middle Lens. To access the other surface of the Inside Lens, set the aperture to f/4.5, set the shutter speed to T(ime), and fire the trigger. The shutter blades should open and expose most of the surface of the Inner Lens for cleaning. Most lens cleaning should stop here.

In the pre-war Argus cameras there is an opportunity to dismantle the Lens Assembly to access the other surfaces of the Outside and Middle Lenses. Simply unscrew the metal retainer that holds the Middle Lens. The Middle Lens should then fall out giving you access to all of the lens surfaces.

But beware! The Middle lens is not reversible! If you replace it the wrong way around, it will cause lens aberrations. Intentionally distorting photographs this way is discussed in Chapter 8.

The Shutter Mechanism

The Ilex Precise shutter is relatively simple, and much easier to service than a more expensive shutter, such as a Compur. Therefore, the author takes certain “liberties” in working on an Ilex Precise mechanism that would not be tolerated on a more complex shutter. If you do not feel comfortable with these liberties, do not read this section.

Before discussing the specifics of the shutter mechanism, the author would like to discuss shutters.

Disassembly of the shutter requires certain tools, so make sure to have them handy. Have a good set of jewelry screwdrivers, a pair of tweezers, and a small container to hold the tiny screws. Wear some sort of eye protection to prevent loose springs from damaging your eyes.

As a shutter mechanism ages, terrible things happen. Dirt enters the mechanism, lubricants thicken, and moving parts start to freeze up or get sticky. To reverse the effects of time, a very thin oil must be injected into the moving joints of the mechanism. It is very important to use as little lubricant as possible. Too much oil attracts dirt and the mechanism will just jam up again; this cannot be overstressed. The problem is, therefore, to place very little oil, much less than a drop, into the right places.

To solve this problem, we will have to turn to Capillary Action. This particular scientific phenomenon maintains that fluids naturally flow into very small places. To see Capillary Action at work, dip the corner of a paper towel into a glass of water. The water will crawl up the paper towel even above the level of the water, defying gravity. The Capillary Action sucks the water up into the pores in the paper towel. This scientific principle will be applied to ensure that just the right amount of oil reaches the correct places.

The best oil to use is high-quality synthetic watch oil. Less costly and easier to find alternatives include sewing machine oil, lighter fluid, and two-cycle engine fuel. The author has used two-cycle engine fuel (40 parts gasoline to 1 part oil) and has not run into any problems.

Now that we know how we will deposit the oil, where do we put it? Do not let lubricant get on the shutter blades or the iris. Try to keep lubricant off of the teeth of any gear. The only part of the mechanism that needs to be lubricated are the gear and lever spindles. These are the shafts that levers and gears spin on. In the Argus shutters, all of the spindles run parallel to the direction light travels through the mechanism; they are easily accessible when you remove the Face Plate of the Shutter (this will be described later).

Now to put it all together. To lubricate the shutter mechanism and timer clockwork, dip one end of a Q-tip, or alternatively a toothpick, into the lubricant. If you are using a Q-Tip, hold the dipped end against a paper towel for one second so that the excess lubricant flows away. Now press it to the spindle end. A small amount of lubricant will seep from the Q-Tip to the spindle and lubricate it. Work the mechanism so that the lubricant is spread around.

The Pre-War Shutter

The pre-war shutter is found on the Argus A, AF, pre-war A2B, and A2F. While the shutter is generally the same, the face plates are differ considerably. This is the same shutter found on the Argus A3 and Argus ColorCamera (CC), and these procedures can be used to repair those cameras as well.

No matter which Face Plate is on the Shutter, disassembly is the same. First unscrew the Lens Assembly from the front by turning the metal cylinder with your hand. Then remove the two tiny screws that sit on the Face Plate. The cosmetic metal plate, or plates, should then fall off. Next, you must turn the Shutter on its side and find the two screws that support the rest of the faceplate. Neither screw appears to be attached to anything; one screw is between the Cable Release Socket and the Aperture Lever, the other is opposite the first near the Aperture Indicator. Once these two screws are undone, the Face Plate should come off completely. The removed portion can be disassembled further, but this is rarely necessary.



Fig. 7-4: Pre-war Shutter Face Plates

Let us take a look at the inside of the pre-war Shutter. Do not attempt to remove any of the screws on the inside of the shutter mechanism; they are difficult to replace. On this shutter, you can fire the Trigger while the Face Plate is removed, it will not affect the mechanism if it is working properly. With the Face Plate removed, the Shutter behaves as if it were set to T(ime); press the Trigger once to open the shutter and once again to close it.

The following letters refer to objects in Fig. 7-5.

A: This screw-headed spindle holds the Trigger in place. Only light lubrication is necessary.

B: These spindles deal with the B(ulb) and T(ime) functions of the shutter. Lubricate the spindle with the screw head. Be sure to allow some lubricant to flow between the two flat sheet-metal levers.

C: These two spindles hold the levers that open and close the shutter by rotating the **D** post. Lubricate them with care so that excess fluid does not flow into **D**. In pre-war A2Bs and A2Fs, there is an extra cam and spring on the spindle with the washer.

D: This post moves back and forth to open and close the shutter blades. Never put any lubrication in this area or you will jam the shutter blades! If your shutter blades are not stuck, you can open and close them very gently with this post.

E: These are the lubrication points for the delay mechanism. For every speed from 25 to 200, this mechanism delays the shutter blades to ensure that the shutter remains open for the appropriate amount of time. If your shutter blades do not close properly when set to 25 speed but work well on 200 speed, the problem most likely lies here.

Download this book for free at <http://www.TheArgusA.com/>

F: This lever rides on a cam on the Face Plate. When you rotate the Face Plate to set the shutter speed to B(ulb) or T(imed), this lever sets the mechanism in **B** to the proper position.

G: This lever also rides on a cam on the Face Plate. It controls the shutter speed from 25 to 200.

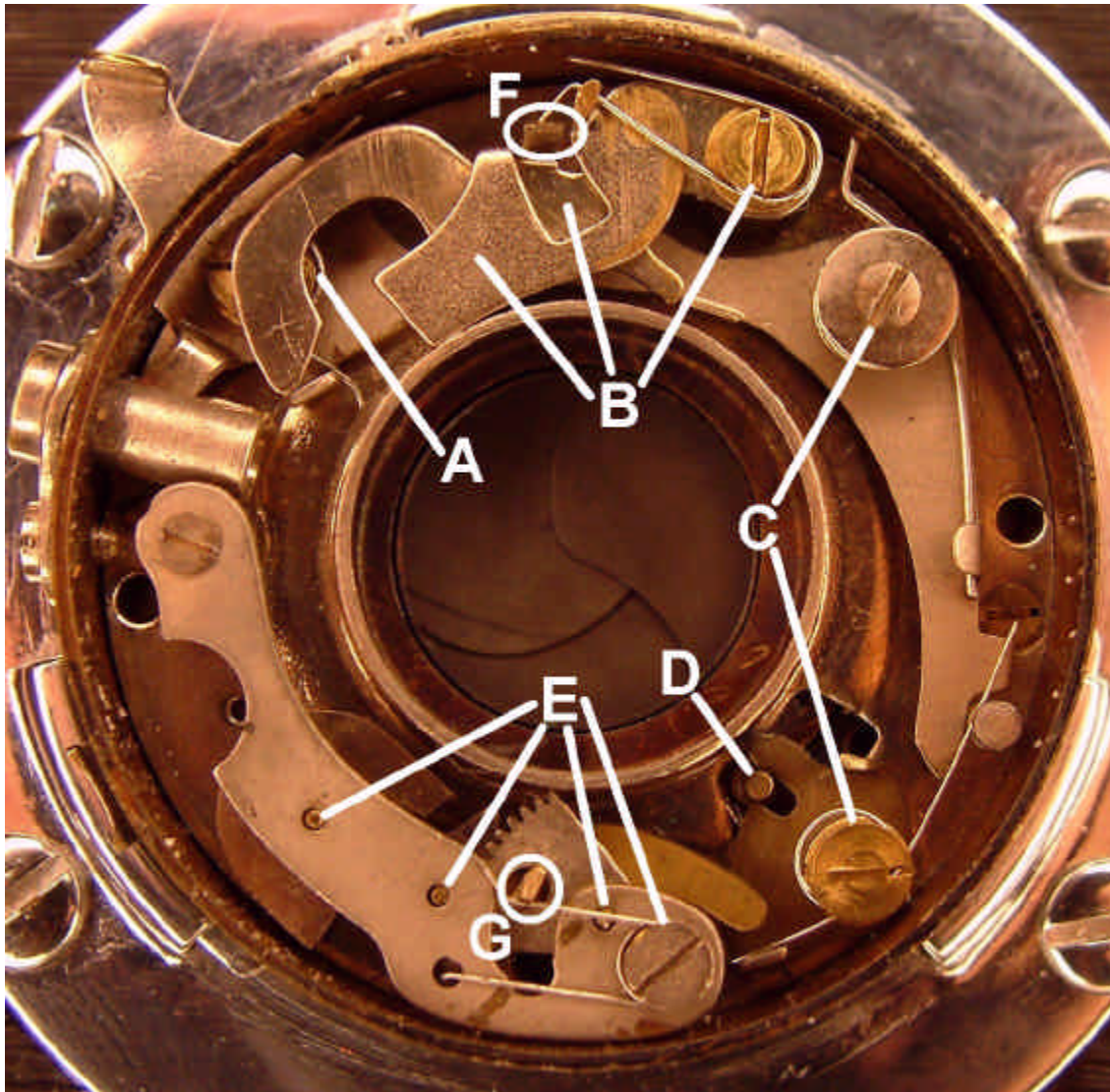

Fig. 7-5: The pre-war Shutter with the Face Plate removed

Reassembling the Shutter is trickier than taking it apart. The steps are the reverse of disassembly, but care must be taken to ensure that all of the various components, particularly the cams on the Face Plate, line up properly. When replacing the Face Plate, ensure that the Cable Release Socket lines up with its indentation on the rim of the Face Plate. The two(or three for the pre-war A2B and A2F) levers that ride cams on the Face Plate must be aligned properly or the mechanism will be jammed. Periodically test the mechanism while reassembling to make certain nothing is improperly assembled.

Download this book for free at <http://www.TheArgusA.com/>

The Post-War Shutter

The post-war Shutter is found on the post-war Argus A2B and the FA. Although there is no direct evidence, the post-war Shutter appears to be the Wollensak Alphax shutter, also used on cameras such as the Bolsey B, Bolsey C, Perfex One-O-One, and others from the post-war period.

The Face Plates to both cameras are very similar and easy to remove. First unscrew the Lens Assembly from the front by turning the metal cylinder with your hand. Then remove the two tiny screws that sit on the Face Plate. The cosmetic metal plate, with the shutter speeds and the aperture settings printed on it, should then fall off. Next, you must remove the two screws underneath the cosmetic plate that just came off. Once these two screws are undone, the faceplate should come off completely. The removed portion can be disassembled further, but it is rarely necessary. No further screws need to be removed inside of the shutter mechanism.

It is very important that you DO NOT FIRE THE SHUTTER with the Face Plate removed without taking precautions. At **A** in Fig. 7-6 sits a spring which may fly off if the shutter is actuated. At best you will have to search for this spring, at worst it can permanently blind you. The easiest way to get around this problem is to gently press your finger on **A** in Fig. 7-6 when firing the trigger. Your finger will keep the spring in place. With the Face Plate removed, the Shutter behaves as if it were set to T(ime); press the Trigger once to open the shutter and once again to close it.

The following letters refer to objects in Fig. 7-6.

A. This spindle, and the two flat levers attached to it, deal with the B(ulb) and T(ime) operations of the shutter. Lubricate the spindle and be sure to allow some lubricant to flow between the two flat sheet-metal levers. In many cases when the shutter has been disassembled before, these two levers are found out of place and down by the mechanism in **E**; they will be visible through the lens of the front of the camera. Simply lift the levers slightly and rotate them back to the position they are seen in Fig. 7-6. Occasionally the spring on the top of this spindle is lost; if this happens the B(ulb) and T(ime) functions will not work. In this case, it is best to remove this entire mechanism (just lift it up right off of the spindle). With the two levers removed, the Shutter will function properly in every mode except B(ulb) and T(ime).

B. This spindle holds the Trigger in place. Only light lubrication is necessary.

C. This spindle holds the lever that opens and closes the shutter. Lubricate it with care. In the Argus FA, the flash synchronization mechanism is also located in this area of the Shutter.

D. This spindle holds the lever that rotates to open and close the shutter blades. If your shutter blades are not stuck, you can open and close them very gently with this lever. The top of this spindle is blocked by a sheet metal plate. To lubricate the spindle, force the lubricant in from the side of the spindle.

E. These are the lubrication points for the delay mechanism. For every speed from 25 to 150, this mechanism delays the shutter blades to ensure that the shutter blades remain open for the appropriate amount of time. If your shutter blades do not close properly when set to 25 speed but work well on 150 speed, the problem most likely lies here. Unlike in the pre-war Shutter, some of these spindles are not easily accessible because the tops are blocked by a metal plate. To lubricate these spindles, force the lubricant in from the side of the spindle.

F. This lever rides on a cam on the Face Plate. When you rotate the Face Plate to set the shutter speed to B(ulb) or T(ime), this lever sets the mechanism in **A** to the proper position.

G. This lever also rides on a cam on the Face Plate. It controls the shutter speed from 25 to 150.

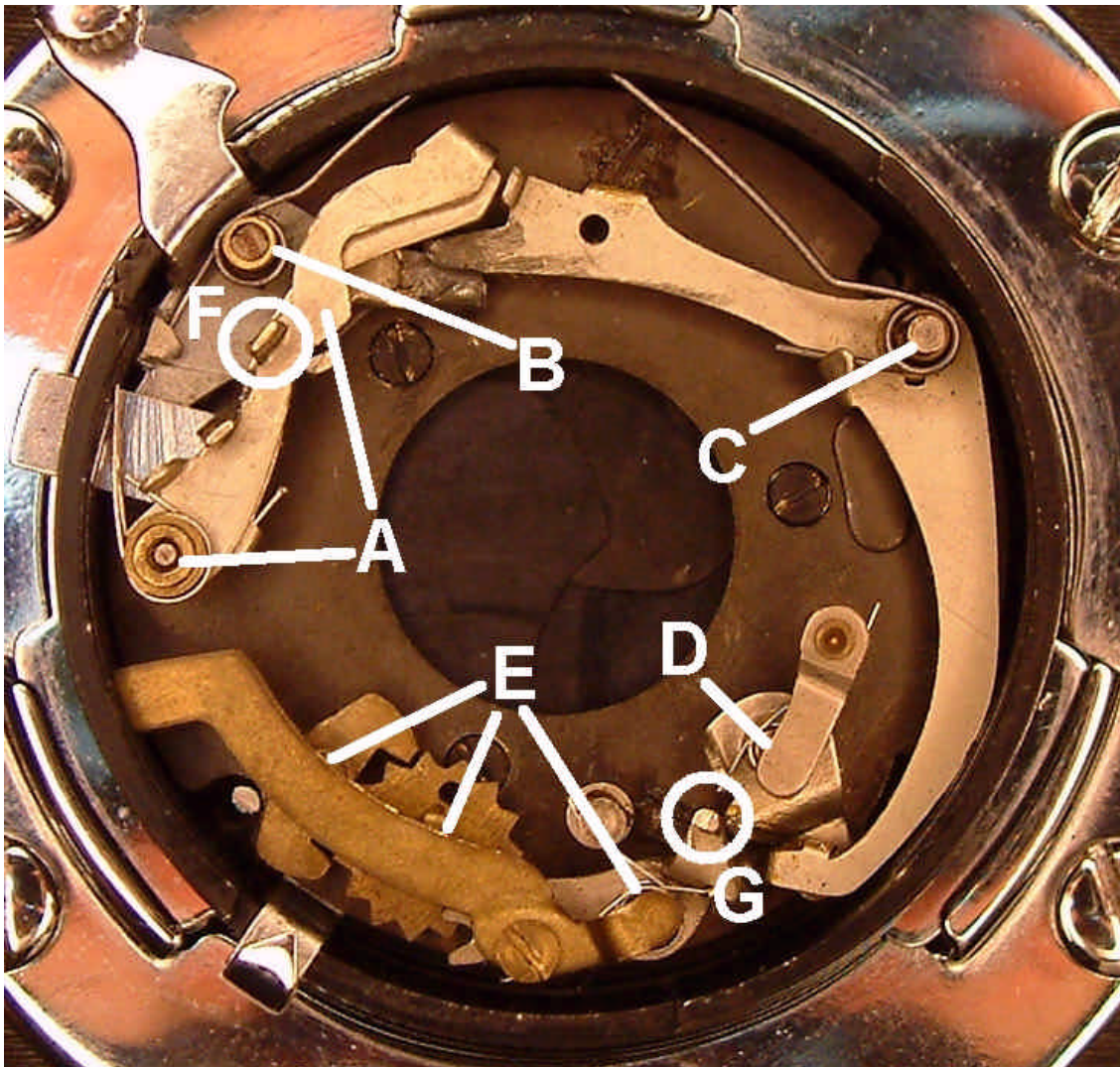

Fig. 7-6: The post-war Shutter with the Face Plate removed.

Again, reassembling the Shutter is trickier than taking it apart. The steps are the reverse of disassembly, but care must be taken to ensure that all of the various components, particularly the cams on the Face Plate, line up properly. When replacing the Face Plate, make sure that the Shutter Speed Lever is at the top of the Shutter. The two levers that ride cams on the Face Plate must be aligned properly or the mechanism will be jammed or damaged. Periodically test the mechanism while reassembling to make sure everything is properly assembled.

The Argus AA Shutter

The Shutter of the Argus AA is unlike any other Argus shutter. It was specially designed to work with a flash and it has only two speed settings, Time and Inst.(instant). The mechanical portion of this Shutter is therefore much simpler than the other Argus Shutters.

Servicing the Shutter is simple.

To disassemble the Shutter, unscrew the Lens Assembly from the front by turning the metal cylinder with your hand. Then remove the two tiny screws that sit on the Face Plate. The cosmetic metal plate, with all of the writing on it, should then fall off. Lift up the next metal plate to expose three screws. Remove the three screws underneath the metal plate that just came off. Once these screws are undone, the faceplate should come off completely. The removed portion can be disassembled further, but it is rarely necessary. No further screws need to be removed inside of the shutter mechanism.

Lubricate the four spindles lightly. Do not allow lubricant to flow into the flash mechanism or behind the shutter.

Reassembly is simple as well; merely reverse the disassembly steps. There is only one cam lever, and it fits easily into a round hole on the Face Plate.

Fixing The Iris And Other Repairs

The aperture iris is one of the components of the Shutter that very rarely breaks. Most often the problem can be traced to the metal ring that the Aperture Lever and Aperture Indicator stem from. This metal ring can be seen and adjusted on the back of the Shutter, after you remove the Neck.

Unfortunately, the shutter mechanism sits on top of the aperture iris. The only way to access the actual iris blades is to remove the shutter mechanism. This can be done by removing the Face Plate and undoing the screws that keep the shutter mechanism in place. This is not recommended because the shutter mechanism has several springs that can loosen or get lost while removing the mechanism. Understand that if you remove this mechanism, you stand a good chance of being unable to replace it.

Finding Light Leaks

Now that you've reassembled the camera and tested it, you may come across light leaks. These are nasty bright spots that appear on the negative and the print that result from light leaking into the camera.

If your camera sprouts a light leak when you first use it, check the Neck for a hairline crack. The easiest way to find such a small crack is to run your fingernail across

the Neck as if you were scratching it. Once found, a crack can be repaired by filling it from the inside with flat black model paint.

The most commonly seen light leak takes the form of a round circle whose diameter is almost the entire width of the negative; it looks like a large fuzzy ring in the middle of your picture. This is caused by light leaking around the edges of the Neck and down to the negative. If this occurs, you must replace the light proof tape that lines the inside of the neck. This procedure is described in the Light-Proof Tape section of this chapter.

Occasionally, light leaks are seen around the sprocket holes of the negative. This implies that the light is leaking through the back of the camera. This type of leak is often the result of a loose Rear Cover. Check the Rear Cover to ensure that it stays firmly in place when attached to the back of the camera. If not, make adjustments to the Lock Catch. Also check for cracks in the bakelite, particularly in the lip the follows the rim of the Rear Cover.

Sometimes horizontal lines appear on the negatives; they are often green if color film is used. These are scratches on the negative made by plastic burrs on the inside of the camera. These burrs are usually found on the edges of the fixed Pressure Plate. The easiest way to find them is to run your fingernail along the edges of the Pressure Plate and all along the film path. When found, burrs can be removed by buffing them off with very fine grit sandpaper or, for lack of a better solution, the “finishing” side of a nail file.

These are not the only light leaks that can appear on an Argus camera, but they are the most common. Be creative when searching for light leaks, and don't give up easily. Always remember that the negative image is upside down when you are looking for the source of a light leak.

8 Tricks And Modifications

When the Argus debuted in 1936, taking a picture was still a hit or miss endeavor. Light meters were primitive and hardly more accurate than charts. Flash bulbs had just been invented and were still quite unreliable. Each type of film came with its own chart of shutter speed and f-stop combinations, depending on the lighting conditions (“Is this BRIGHT SUN or HAZY SUN?”). Taking a picture meant that you had to take a chance that all of your settings were correct.

This uncertain environment lead many photographers to experiment with the available photographic equipment and techniques to get the pictures they wanted. Some of the earliest practical flash guns were invented by reporters who needed a dependable flash in uncertain conditions. Kodachrome, the first feasible color film, was originally developed by two photographers who doubled as musicians. The photographers of yore understood that if they wanted a unique picture, they had to fit the unique circumstances themselves.

It was in the spirit of these entrepreneurial souls that this chapter was written. While the Argus works well enough the way it was designed, it can be pushed and adapted to work under a wide variety of circumstances.

This chapter is divided into two main sections: Tricks and Modifications. Roughly defined, Tricks are anything you can do without actually altering the camera. Modifications are changes you can make to your camera in order to take make it adapt to a certain need. Everything but the Cold Shoe Modification in this chapter is reversible and leaves no permanent damage to the camera, in order to preserve your camera’s historical value.

Tricks

Using “Ground Glass”

For close-up photographs of less than five feet, parallax tends to make the View Finder inaccurate. Objects that are centered on the View Finder are pushed to the edges of the negative, people are decapitated, etc. This problem is not unique to the Argus camera; any camera that uses separate viewing and picture-making lenses suffers from the same difficulty.

To compensate for this error, Argus photographers used to remove the Rear Cover and place a piece of ground glass against the film track. The ground glass would then show exactly what the negative would see, without any parallax. The photographer would then position the camera, remove the glass, load the film, and take the picture.

Ground glass can still be used for the same purpose, but there is an easier and cheaper alternative. Frosted Scotch™ tape, easily found and very cheap, can do the job almost as well. Scotch™ brand refers to it as 810D, but most no-name brands will work just as well, so long as the tape is evenly frosted. A width of ¾ of an inch works best.

Take a short piece of tape, about two inches long, and run it along the top track of the film plane, exactly where the 35mm negative will sit when you take a picture. Try to keep the tape from bending or bubbling; the flatter it is, the more accurate your view will be. If you repeat this procedure for the bottom track the two pieces of tape should overlap slightly. Again, try to keep the tape as flat as possible between the two tracks.

Download this book for free at <http://www.TheArgusA.com/>

Set the aperture at f/4.5. You can now look through the back of the camera to see exactly what the negative will look like. Keep in mind, however, that the image will be upside-down.

If you intend to take many close up pictures, you can mark the front View Finder lens with a fine-point water-soluble marker to indicate any changes due to parallax.

Taking Close-Up Pictures

One of the main advantages of the Argus AF and A2F at the time they were made was their ability to focus on objects very close to the lens. These cameras could focus on an object 1.25 ft away, whereas most other cameras could go no closer than 3 ft away without an adapter. The two-position Argus cameras could also focus very closely if used with the Portrait or Copying Adapters.

The table below indicates the approximate focusing distances and fields of view for Argus cameras in various configurations. These and any other configurations can be confirmed using the “Ground Glass” method described above. Remember to measure all distances from the front of the camera Body, where the Neck and the Body meet.

Camera Setup	Focusing Distance	Field Of View
2 Position Focus set to Infinity Focus with Portrait Adapter	40	18 x 27
2 Position Focus set to Near Focus with Portrait Adapter	32	14 x 21
2 Position Focus set to Infinity Focus with Copying Adapter	22.5	10 x 15
2 Position Focus set to Near Focus with Copying Adapter	19.25	8 x 12
2 Position Focus set to Near Focus with both Adapters stacked	14	5.5 x 8.25
Variable Focus set to 1.25 ft	15	5.75 x 8.5
Variable Focus set to 1.25 ft with Portrait Adapter	12	4.5 x 6.75
Variable Focus set to 1.25 ft with Copying Adapter	10.5	3.5 x 5.75
Variable Focus set to 1.25 ft with both Adapters stacked	9	3 x 4.5

Table 8-1: Specifications for close-up pictures (All dimensions in inches)

Double Exposures

Double exposures were once the bane of the amateur photographer’s existence. Without double exposure protection, photographers would often take a picture, forget to wind the film, and then take another picture on top of the first one.

Since WWII, double exposure protection has been standard on almost all 35mm cameras, even today’s disposables. While this prevents accidental double exposures, it also doesn’t allow for the deliberate double exposure. Thus the “art” of the double exposure has fallen into disuse. The Argus, however, has no such protection. The user is free to take as many pictures as desired on top of the same negative.

This allows for a fair deal of experimentation.

Early “evidence” of ghosts was faked by taking a picture at half the necessary shutter speed, inserting a ghost into the scene, and then taking the picture again at the same shutter speed. This effect would make the ghost translucent.

There are other ways of taking advantage of the unique opportunities offered by double exposures. Changing any of the parameters of the same photograph produces interesting effects. Altering the focus, or switching from a deep depth of field to a

shallow depth of field, make for interesting effects. Cityscapes can be made with the first exposure during the day and the second at night. While some of these effects require computation to determine the proper exposure times and apertures, they offer some truly unique approaches to picture taking.

Other creative applications of the double exposure exist and are worth exploring.

Intentional Lens Aberrations

As mentioned in Chapter 7, the Middle Lens of the pre-war Shutters can be removed for cleaning.

If this lens is turned around before it is replaced, it will distort the image on the negative. This distortion, which smears the image away from the center of the image, is similar to a coma aberration and can be manipulated by changing factors such as focus and aperture size. The overall effect of the distortion is that of motion in the axis of the lens. In simple terms, the outside edges of your photographs will be blurred.

Technically, there is supposed to be a slight bevel on the Middle Lens to indicate direction. When properly installed, the beveled lens edge is on the side facing the Inside Lens. In practice, however, this bevel is often too small to be seen or not present at all. The only sure way to know if your lens is installed properly is to take some test pictures.

Modifications

The Most Common Modification

The most common Argus modification is the “fake” A2F. This involves taking the Neck and Shutter of an AF and putting them on the Body of an A2B. Four simple screws and you’re done. Incidentally, this does not make the camera any more or less valuable.

This bastard camera combines the variable focusing of the AF with the Extinction Meter of the A2B. It is a worthwhile modification as long as you intend to switch them back.

Modifying Old Filters

Often, when trying to acquire a complete set of Argus filters, one comes across extra filters. Whether they are extras or ones already found or simply damaged beyond use, they can still be utilized.

The simplest use of an old filter is converting it to a lens cap. Simply paint the lens or filter portion with flat black paint. Ensure that it is light tight so that your cap will protect against accidental exposure.

Another use is as an adapter for a filter holder, such as the Series V Adapter. As mentioned earlier, the Series V Adapter fits only on the post-war A2B and the FA, but an old Argus filter can be used to adapt it to a pre-war model. Simply force out the filtering element by pushing it from the objective side, not the side that will slip onto the Lens Assembly. The filtering element and its retaining ring should pop out; keep these somewhere safe so that you can restore them if necessary. Then wrap the outer rim of the objective side of the filter with tape until the Series V Adapter fits on it snugly. Now you will be able to use that Series V Adapter, and all of the various Series V filters, with a pre-war Argus.

The Pinhole Argus

The Argus camera can be changed into a pinhole camera. But so can a shoebox. What makes the Argus a better pinhole camera than a shoebox?

1. The Pinhole Argus can easily be converted back into a normal camera with no permanent damage. But can't a shoebox still hold shoes? Touché. Nevertheless, read on.

2. The View Finder can be used to determine what will appear on the negative.

3. With the information in this text, you can roughly determine the exposure time necessary to take a competent picture. This will save time, effort, and film.

4. The 35mm film transport system allows the use of multiple pictures on normal 35mm film without needing a darkroom to load or unload.

5. The pinhole material can be removed and replaced in the middle of a roll of film without needing a darkroom.

6. The T(ime) function on the Shutter allows for extremely simple control of light.

7. A shoe box doesn't have a tripod socket, which is almost mandatory for a pinhole camera.

8. The Pinhole Argus is small, portable, and looks like a camera, whereas a shoebox is big, bulky, and looks like a shoebox.

On this dubious foundation of reasoning, we begin.

The first step is to unscrew the Lens Assembly. This leaves only the rear-most lens, which is referred to as the Inside Lens in the last chapter, in the camera.

The Inside Lens is the most difficult lens to remove. Technically, it is unscrewed from the inside of the Neck. Unfortunately, this lens is screwed-in so tightly that it is nearly impossible get a good grip on it to remove it. To get at this lens, you must remove the Shutter from the Neck, using the technique described in Chapter 7. Now that all of the lenses are removed, reassemble the reattach the Shutter to the Neck.

Cut a piece of aluminum foil into strips 1 1/8th inch wide. Color the duller side of the aluminum foil with a black permanent marker. This black side will face the inside of the camera.

Now to make the hole that gives the camera its name. Put it exactly in the middle of the aluminum strip. Place the aluminum foil on a flat surface and use a sewing needle to make the hole; sewing needles are very sharp and have a gradual slope. You can control the size of the hole by changing the flat surface you are working on. If you want a small hole, use a hard surface like metal so that the needle doesn't penetrate very far through the surface. If you want a larger hole, use a softer surface, like a Formica kitchen counter, which will allow the needle to sink into it.

Take the strips (several at a time) and scan them on a computer scanner. There are two important reasons for this: to confirm that the pinhole is round, and to measure the size of the pinhole. Making certain that it is round is easy enough. To determine the diameter, is a bit trickier. Set the scanner to the maximum scanning resolution, usually 300 to 1200dpi (dots per inch). Scan a ruler or measuring tape, and zoom in on the picture so that you can see the individual image pixels. If your scanner is set properly, you should be able to predict the number of pixels between two lines on the ruler that are 1/16th of an inch apart. 300dpi should have about 19 pixels, 600dpi should have 38

pixels, and 1200 should have 75 pixels. Once you have double-checked that your scanner is properly set, scan the strips of aluminum foil and zoom in on the holes. Count the number of pixels that fit lengthwise in the hole and divide by the dpi setting. That will give you the correct diameter of your pinhole. For example, if the scanner is set to 600dpi and the hole is 9 pixels across, the diameter of the hole is 0.015 inches. ($9 \div 600 = 0.015$). Table 8-2 indicates the various hole diameters that will produce the “sharpest” pictures.

Shutter Position	Optimum Hole Diameter	Approx. Pixels at 300 dpi	Approx. Pixels at 600 dpi	Approx. Pixels at 1200 dpi
Shutter in storage position	0.0113 in	3.5	7	13.5
Shutter in extended position	0.0128 in	4	7.5	15.5
Variable Neck focused at 1.25 ft	0.0136 in	4	8	17

Table 8-2: Optimum hole specifications for various shutter positions

Set the Shutter to either B(ulb) or T(ime), whichever you intend to use. The shutter speed cannot be adjusted once the aluminum foil is mounted. Ensure that the aperture is set to f/4.5. Remove the cosmetic metal plate from the Shutter by undoing the two screws on the Face Plate. Only the thin metal disc that says “Argus” should come off, not the entire Face Plate. Place the aluminum foil strip, with the black side down, on top of the Shutter where the Lens Assembly would normally fit. Ensure that the pinhole is centered on the Shutter and that the strip is running directly between the two empty screw holes. Carefully replace the cosmetic plate back onto the camera; this should force the aluminum foil to tighten by the pinhole. Make certain that as the cosmetic plate returns to its original position, the screw holes line up; if they are covered by the aluminum foil, tear it away with a pin. The cosmetic plate can be secured in one of two ways: it can be screwed down or it can be taped. If the screws are continuously removed and replaced, there is a chance of damaging the threads or the head of the screw. If taped down, make certain that it is secure. If the aluminum foil has a tendency to tear around the edges when mounted, as some types do, line the outer edges of the aluminum foil with tape.

Some pinholers feel that aluminum foil is not the best pinhole medium. They prefer thicker aluminum like that found on disposable pie plates, or some other thin, opaque material. To mount any other material, you should tape it to the aluminum foil strip using the following technique. Rather than poking a pinhole through the aluminum foil, cover the center of the aluminum foil with double-stick tape (tape that is sticky on both sides). Use a hole-punch or razor to cut a hole in the middle of the double-stick tape. Now take the pinhole medium and press it onto the double-stick tape with the pinhole over the hole you just made. Then mount the aluminum foil strip normally.

Now that the camera is built, the only real problem is to determine the exposure time. Exposure information for the optimal hole diameters of the various Shutter configurations is shown in Table 8-3. The f/16 Exposure Factor is the number used to calculate an approximate exposure time on 100 ISO film. Simply take the exposure time recommended by a light meter at f/16 and multiply it by the exposure factor. For example, if the light meter says that the f/16 exposure time should be $1/100^{\text{th}}$ of a second

and the shutter is in the extended position with the optimum pinhole size, the exposure time should be 1.3 seconds ($1/100 \times 130 = 1.3$). Bear in mind that this calculation assumes that the pinhole is exactly 0.0113 inches in diameter, perfectly round, the film is without reciprocity, etc. These conditions are too ideal to consider realistic. If the hole is larger, decrease the exposure time, if it is smaller, increase the exposure time. To ensure that at least one good pinhole picture is made, try taking multiple photographs with double and half of the calculated exposure time.

Shutter Position	Optimum Hole Diameter	Approx. f-stop	Angle of View in degrees	f/16 Exposure Factor on 100 ISO Film
Shutter in storage position	0.0113	162	41	100x
Shutter in extended position	0.0128	183	33	130x
Variable Shutter focused at 1.25 ft	0.0136	194	29	150x

Table 8-3: f-stop and exposure times for various shutter configurations

When you remove the aluminum foil after you are finished, hold it up to the light to inspect it for tears. This will help determine whether your photographs may have been ruined by a light leak rather than over-exposure.



Fig. 8-1: The Pinhole Argus during construction (left), and ready to use (right).

Amateur pinhole photography is, at best, an inexact science. The relatively tiny 35mm negative is also not the ideal format for this type of photography. If the results are disappointing, don't give up. Part of the fun of pinhole photography is the experimentation and perfection of the technique.

Special Effects For The Proletariat

Some people enjoy experimenting with cameras that take fuzzy or otherwise imperfect pictures. They use cameras like the Diana, the Holga, and the Lomo. When cleaned and operating correctly, the Argus makes reasonably sharp pictures. With a

slight modification, however, the Argus can produce all sorts of “artistic flaws”. It also allows a surprising degree of control over the intentional flaws.

This modification places a “mask” about 1/8th of an inch above the focal plane, between the negative and the lens. Therefore, light traveling through the lens must pass through the mask before it reaches the negative. If the mask is flat and clear the image should remain the same, but if the mask is imperfect in any way it will distort the image.

So what kind of imperfections can a plastic mask have in order to make the photograph more interesting? It can be scratched, melted, burned, cut, colored, written on, crinkled, etc. It can be stained with water, oil, ink, grape juice, etc. It can be a hard plastic like acetate, a soft plastic like cellophane, or something in between like the wrapper of a Twinkie. It can be flat or bent or wrinkled. The imperfections can be across the whole mask, along the edges of the mask, or just in the middle. If using black and white film, the mask can be colored to simulate the effects of a filter. The mask doesn't even have to be plastic; any transparent or translucent material will work just as well. For example, tissue paper dampened by a few drops of oil produces a dreamy effect, similar to an impressionist painting.

The deformation of the mask is a part of the creative process. Scratching the mask with fine steel wool in an even, random pattern will make the picture blurry. If the scratches are just in a few similar directions, the picture will smear in just one direction. Coarsely grained sand paper can be used to produce visible parallel lines.

The mask is placed inside the camera 1/8th of an inch above the negative. When the Body is separated from the Neck and Shutter assembly, the mask can be placed inside of the Body cavity precisely on top of the focal plane. Only 1/8th inch of the bakelite Body will separate the negative from the mask. The spring in the Neck will keep the mask flat once the Neck is replaced.

First, a masking material must be found. Art supply stores sell acetate sheets that work particularly well, especially when protected from scratches by sheets of tissue paper. They are also commonly available in yellow, red, green, blue, and grey. Transparency sheets for overhead projectors are also a good source of masking material, so long as they are not scratched up. Scientific supply stores sell thin sheets of polarized plastic that add a polarizing effect.

Now the masking material must be cut into the shape of the Body cavity. The easiest way to do this is to use the Body itself to outline the shape. Remove the Neck and Shutter assembly from the Body by undoing the four retaining screws. Lay the Body, with the front of the camera down, onto the masking material and trace the inside of the Body cavity onto the material. Use scissors to cut out the resulting circle, taking care not to touch or damage the round mask.

Place the mask into the body cavity. Ambient dust from the camera body and the light-proof tape will land on the mask and must be cleaned off. Dampening the light-proof tape with a few drops of water helps to minimize the dust that comes off of it. Once the filter is at the bottom of the cavity, replace the Neck and Shutter assembly.

While loading the film into the camera, be careful not to get dust onto the film side of the filter. Try not to rotate the Neck and Shutter because the Neck spring may rotate and damage the mask.

Unfortunately, there is no easy method to determine the “filter factor” for a newly installed mask. Run a roll of test film under various lighting conditions to determine the

working filter factor. This factor will remain the same for every mask that is similarly made.

Because of ambient dust and scratches, the mask will not last long before it needs to be removed or replaced. The light-proof ribbon will also dry and begin to sprinkle dust on the filter. Allow it to dry out completely after removing the filter to prevent the ribbon from getting moldy.

The Closer Two-Position Focus

The focusing mechanism on the Argus A and A2B is limited because it can only focus at two distances: Infinity to about 15ft, and about 15ft to 6ft. This modification allows the user to temporarily shorten these distances to take closer pictures.

Before we begin, however, we must undertake a short discussion about the two-position focus.

Focus, of course, can only be set for one distance. Depth of focus gives us a range within which the sharpness of objects is still acceptable. Unfortunately, the definition of “acceptable” has changed considerably since 1936. Adding to the confusion is Argus’ constant redefinition of the distances for the close-up focus position. This range started at 6ft to 12ft, then became 6ft to 18ft, and finally settled at 6ft to 15ft.

The best action to take in order to determine the true focus distances is to test the camera for the correct distance. Use the “Ground Glass” method described earlier in this chapter to determine the distance at which the image is sharpest, and then try to take all of your pictures from this distance. Don’t forget to use the smallest practical aperture when taking pictures to increase your depth of focus.

This modification adjusts the original focusing distances into two closer ones. The only drawback is that the photographer loses the ability to focus at infinity, albeit temporarily.

Begin by unscrewing the four screws that hold the Neck and Shutter assembly to the Body. To *shorten* the focus distances, the distance between the negative and the lens must be *increased*. This can be accomplished by placing some sort of spacers between the Body and the metal plate with the Locking Lugs.

These spacers can be made of any material, so long as it is hard and of uniform thickness. Flat washers for 4-40 screws are available at any hardware store and are excellent. Thin cardboard also work well. These spacers should not be much thicker than 1/16th of an inch, however, because these screws support the Neck and a knock on the Neck may rip the screws out. If the spacers are 1/16th of an inch thick, the infinity position focusing distance drops to about 10ft and the close-up position distance drops to about 4ft.

Place the spacers on the Body and reattach the four screws. The metal plate with the Locking Lugs should now hover away from the Body. Line the outside edges of the metal plate with an opaque adhesive tape, like black vinyl electrical tape. The tape is necessary to prevent stray light from reaching the negative.

The modification is now done. The camera still has two focusing distances, but they have been shortened considerably. To determine the new focusing distances, use the “Ground Glass” method.

When you want to revert back to the original configuration, simply remove the spacers and the tape.

Adding A Cold Accessory Shoe

Accessory shoes were once very common on cameras. Some cameras like the UniveX Mercury had two accessory shoes, a hot one for a flash and a cold one for an extinction meter or rangefinder. Every accessory shoe made these days, however, is intended for an external electronic flash unit.

There are several useful accessories that can be attached through a cold shoe. The most common is a rangefinder.

Another helpful accessory for a cold shoe is an exposure meter. Argus manufactured several cold shoe mounted meters like the L44 and the LS-3, and other manufacturers produced similar meters as well. When buying an Argus light meter, ensure that it uses normal photographic standards, and that it is not intended for the Matchmatic system, like the LC-3 shoe mounted light meter.

The best place to get an accessory shoe is an old camera. Many of the cheaper cameras, from the 30's to today, have accessory shoes held on by screws. This is the type to get. Junk and toy cameras often have this type of accessory shoe, as well.

There are two logical places to put an accessory shoe on an Argus A. The area to the right of the Counter Dial (above the cavity for the 35mm film cartridge) works well if it is only intended to hold something small, like an Argus light meter. Make sure to leave enough room to be able to access the Counter Dial Release. If you want an accessory shoe to hold larger objects like rangefinders, place it directly beneath the Neck between the Tripod Socket and the Rewind Knob.



Fig 8-2: An Argus LS-3 light meter mounted by cold shoe on an Argus A2F

Older accessory shoes were made to grip the accessory, whereas newer ones were designed assuming that the accessory would clamp down on them. You may have to bend the accessory shoe if the accessory is not held firmly in place.

9 Finding An Argus In Good Shape

The 60 Second Camera Evaluation

You are walking down the street of a city you are visiting and something black, yet chromed, catches your eye. As you approach it, you see that one of the many antique stores in this part of the city has just put an Argus A2B in the window, just like the one you've always wanted. You walk in and stare at the lamp next to the camera, so the lady at the counter doesn't notice your interest in the Argus. You know that if she sees you eyeing the camera, its price will skyrocket. To distract her, you approach the counter and ask if she has any "late 17th century Chippendale depression glass of the Prussian style." You do not know what these words mean, but you heard them on "Antiques Roadshow" and they impressed you then. As you so coyly predicted, she claims to have seen some in the back room and goes to fetch it. You are left with about 60 seconds before the counter lady returns with a cracked chamber pot. How do you determine whether the A2B is useable or beyond repair?

The first thing to do is look over the camera to see if there are any obvious flaws. Are all of the knobs there and do they turn freely? Are the lenses in the viewfinder? Is it very rusty (minor specks of rust can be cleaned)? Is the body cracked? If its an A2B or A2F, is the extinction meter there and is the Chart and Slide complete? Is the lens scratched up? Does the aperture lever and speed adjustment move rather easily? Is there a lever or button to trigger the shutter? [Certain models (A2Fs and early A2Bs) had a removable button, and if its broken or not present, you can only fire the shutter with a cable release.] If any of the above reveal defects in the camera, do not buy it unless you want it for parts.

Rotate the Head of the camera to expose the Neck. If it is an AF or A2F, rotate the focus dial. If it moves, even if with difficulty, then it is probably good. Push the Head into the camera to see if there is any slack in the focus dial mechanism. If there is any slack, the Neck will not focus properly.

Determine if there is film inside by turning the Rewind Knob. It should turn very easily if there is no film inside. If it has film, rewind it if you want to try to develop it.

Remove the back cover and inspect the interior. Is there evidence of spilled chemicals or corrosion on the inside? [The sprocket wheels can be slightly corroded, just so long as they turn.] Is the inside of the lens area basically clean? Is the door in one piece, with either a fixed or floating film plate in place?

Now test the film transport mechanism. Run a finger from right to left along the sprocket wheels so that they turn the way advancing film would turn them. Soon the sprocket mechanism should stop and lock up. Push the spacing button towards the viewfinder and hold it there while trying to turn the sprocket wheels. They should now move freely. Now try to turn the sprocket wheels the other way (finger goes from left to right). You should be able to spin them and hear an audible click every time the sprocket wheels go around once. If you can do everything in this paragraph, then the film transport is functional.

Next you must check the shutter and aperture. Set the shutter speed to its maximum, either 200 or 150. Look through the lens at a bright light and click the shutter.

Download this book for free at <http://www.TheArgusA.com/>

You should see a very temporary flash of light. If you consistently see a flash of light while firing the shutter, then the shutter mechanism is probably still good and will be easily restored. If you cannot fire the shutter and see the flash of light at the top speed, you may not be able to use the camera without sending it to a repairman.

To test the aperture, set it to the smallest setting. Fire the shutter and ensure that the aperture hole is small and round, not oval or egg shaped. Then set the aperture to f4.5 and fire the shutter to ensure that the aperture opened up completely. The aperture lever should move smoothly.

Now set the shutter to 25, the lowest speed, and fire the shutter. If it still splashes you with light, the shutter may not even need repair. More likely, however, the shutter will get stuck while trying to close. This is not a big problem and fixing it is described in Chapter 7. Try the shutter in T and B. They probably won't work either, but often can be fixed, or at least disabled.

If the Argus passed all of the tests above, it can easily be turned into a functional camera. Any larger problems would require the skills of a camera repairman. Well over two-thirds of the cameras that the author has seen pass the above test, and those that were purchased were easily restored to working order using the techniques described in Chapter 7.

Finding An Argus Online

There are two major sources of cameras online: professional photography shops and auction sites like eBay.

Several photographic shops have posted their stock online, and their prices run the gamut from a good deal to bloody murder. They do, however, do their best to represent their products accurately, and since they usually own brick-and-mortar stores you can call them and talk to them if you are unclear about the condition of a camera.

Online auction sites offer more variety, but often the sellers doesn't know what they're selling. They picked it up at an estate sale or found it in a deceased relative's attic and now want money for it. It is always described as antique and rare and a beautiful piece of history. About half of the model designations are wrong (FAs are described as AAs, A2Fs as As, etc...). They often can't tell you if it works, or what the serial number is, or anything besides the picture they posted. Therefore, the best way to determine anything about the camera is to look at their pictures. If you are interested, ask the seller to e-mail you more pictures. In many cases, they do. Compare them with pictures in this book to determine the model and other information.

When searching for an Argus online, there are several key words to use in a search engine or auction searcher. Use the following: "Argus", "Anastigmat", "Ilex", "Precise", "4.5", and "IRC". Argus produced many types of cameras, however, and to filter them out of your search enter the following words into the NOT function of your search engine: "Cintar", "3.5", and "rangefinder".

10 For More Information

Throughout the years, much has been written about 35mm cameras, their use, and their repair. The author has enjoyed many of these books and would like to point out several that stand out from the crowd.

The best history of American 35mm development and the early evolution of the 35mm camera is *Glass, Brass, & Chrome: The American 35mm Miniature Camera*, by Kalton C. Lahue and Joseph A. Bailey. Reprinted in 2002 by the University of Oklahoma Press, this book is obviously a labor of love. Lahue and Bailey outline all of the major American-made 35mm trends, companies, and camera models from the early thirties to the early seventies. In addition to the Argus A cameras, this book also covers other cameras by Argus, UniveX/Universal, Kodak, Perfex, Bolsey, Kardon, Bell & Howell, Realist, and a host of others. The book ends on a comical note: the authors lament the probable demise of 35mm film in favor of the then-growing but now-defunct 126 cartridge. Writing in the early 1970s, the authors probably intended the book as a eulogy for 35mm photography. Who suspected that it would remain a dominant force in photography for at least another thirty years?

If you want to learn about cameras in general, the best text on the subject is the first book in Ansel Adams' three-volume "Photography Series". Simply named *The Camera*, it covers every aspect of the camera, from lenses to shutters to film formats and beyond. This professional and timeless text demystifies many of the secrets behind the intricacies of a camera and how to take advantage of them.

If looking to learn about camera repair, an outstanding text on the matter is Edward H. Romney's *Revised Basic Training In Camera Repair*. Romney discusses every aspect of camera repair and calibration. Of particular value are Chapter 5 (Testing and Adjusting Shutters) and Chapter 6 (Testing Sharpness of Lenses and Cameras . . . Adjusting Focus). These two chapters each approach their topic by looking at inexpensive ways to accomplish difficult tasks. The simplicity and usefulness of the techniques described is truly amazing. You can buy this book straight from the author at www.edromney.com.

If you want to learn how to take a good picture, pick up a copy of the *National Geographic Photography Field Guide* by Peter K. Burian and Robert Caputo. This book does a good job of covering the basics of photography, from cameras to film to subjects. It is also small enough to fit in a camera bag.

As mentioned earlier, any of Kodak's "How To Make Good Pictures" books are excellent for vintage photographic information. They offer a good look at the state of amateur photography at the time of printing.

Another outstanding, and free, source of information about Argus cameras and photography is the internet. The most notable Argus-oriented web page is the Argus Collector's Group (ACG) page. Located at <http://arguscg.tripod.com/acg/index.html>, the ACG collects and makes available all sorts of information about Argus cameras. They also run a particularly lively e-mail-based mailing list on Yahoo! Groups at <http://groups.yahoo.com/group/arguscg/>.

Download this book for free at <http://www.TheArgusA.com/>

Appendix A: Argus A Patent

Aug. 25, 1936.

C. A. VERSCHOOR

2,052,261

PHOTOGRAPHIC CAMERA

Filed March 12, 1936

2 Sheets-Sheet 1

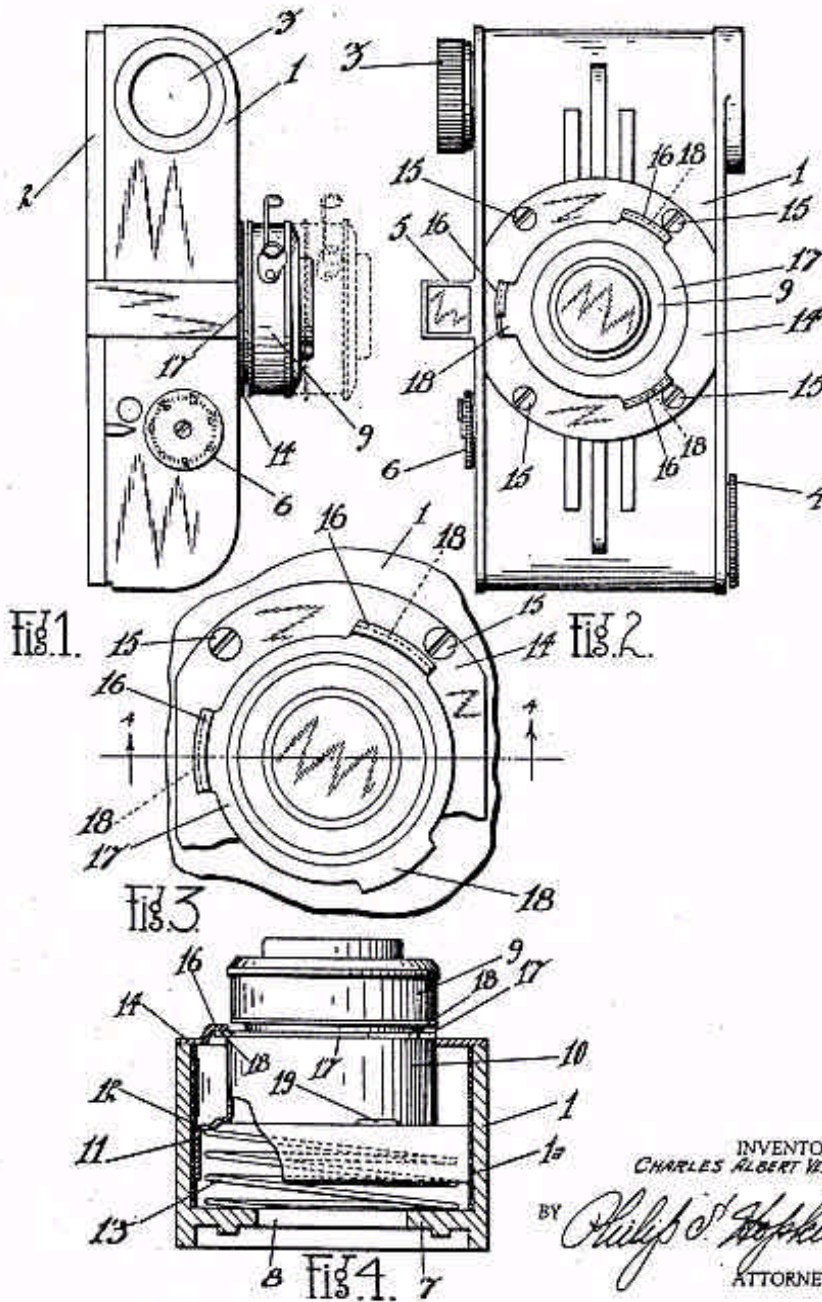

Download this book for free at <http://www.TheArgusA.com/>

Aug. 25, 1936.

C. A. VERSCHOOR

2,052,261

PHOTOGRAPHIC CAMERA

Filed March 12, 1936

2 Sheets-Sheet 2

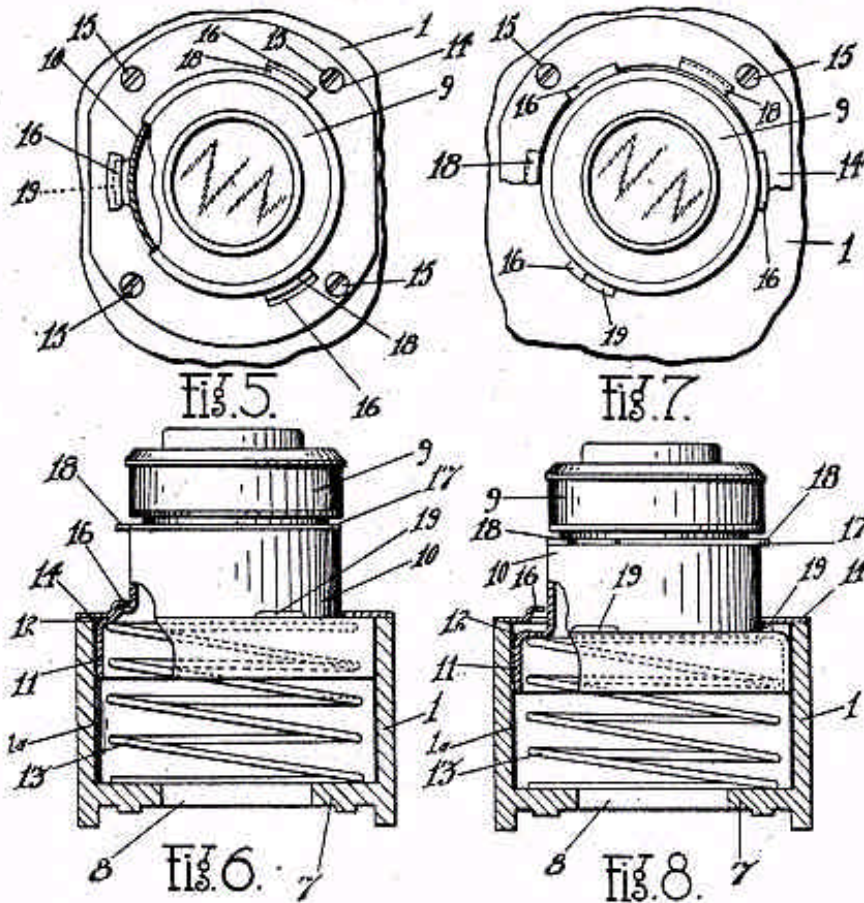

INVENTOR.
CHARLES ALBERT VERSCHOOR.

BY *Philip S. Hopkins*
ATTORNEY.

UNITED STATES PATENT OFFICE

2,052,261

PHOTOGRAPHIC CAMERA

Charles Albert Verschoor, Ann Arbor, Mich.

Application March 13, 1936, Serial No. 68,500

6 Claims. (Cl. 88-57)

My invention relates to photographic cameras and particularly to a lens and shutter mounting therefor.

My invention relates especially to cameras of the so-called miniature type now enjoying commercial popularity and with which relatively small sharp images are obtained on small sized film of the order of 35 mm. width and then enlarged therefrom as desired. This type of camera has many advantages over the larger cumbersome sizes in that it is compact and easily carried in the pocket, and permits of economy in the making of pictures by virtue of the small sized film used, and from which only the selected exposures are enlarged for prints.

One of the principal objects of my invention lies in the provision of a very simple mechanical mounting for the lens and shutter unit on the camera by means of which this unit may be retracted to a position directly adjacent the camera body when not in use to thus reduce the over-all dimensions of the camera for convenient carrying but which permits the extension of the lens and shutter unit to outward position whereby a relatively long focus lens may be used with its attendant advantages.

Another object lies in the provision of means whereby the lens and shutter unit may be adjusted in its operative position for focusing.

More specifically my invention pertains to a telescopically mounted barrel-like lens and shutter support normally urged outwardly to picture taking position and which may be readily and quickly retracted and secured in its retracted position, for convenience in carrying. Cooperating means are provided between the lens and shutter mounting and the camera whereby adjustment may be made for focusing in the picture taking position.

The simplicity of the mechanism and its economy of manufacture form another object of this invention and commercially an important one because of the reduction in cost of manufacture.

Other objects and advantages will be apparent as the description proceeds, reference now being had to the figures of the accompanying drawings forming a part of this application and wherein like reference numerals indicate like parts.

In the drawings:

Figure 1 is a side view of my improved camera showing the lens and shutter unit in full lines in its inoperative position and in its operative position in dotted lines.

Figure 2 is a front plan view of the camera.

Figure 3 is a detail front view of the lens and

shutter mount in its inoperative position on the camera.

Figure 4 is a detail sectional view taken on the line 4-4 of Figure 3.

Figure 5 is a detail front view of the lens and shutter mount in its furthest extended position for "close-ups", certain parts being broken away for clearness.

Figure 6 is a detail side view of the lens and shutter mount in the position shown in Figure 5 and including in section the position of the camera body within which the unit is mounted.

Figure 7 is a detail front plan view of the lens and shutter mount in its operative position and adjusted for "long shots", certain parts being broken away for clearness.

Figure 8 is a view similar to Figure 6 but showing the same elements in the position shown in Figure 7.

I have shown and will describe my invention as provided with two positions of focus—namely, for "close-ups" and for "long shots". It will be clear, however, from the subsequent description that additional positions of adjustment may be provided for different focusing steps.

The reference character 1 refers generally to the body of the camera which may be of any desired construction and material. The camera is provided with a suitable removable back 2 to permit loading and unloading of the film within the body of the camera, and for making possible the attachment of the camera to an enlarger apparatus wherein the camera lens serves as the projecting lens for the enlarger. A winding piece 3 is provided for the take-up film chamber and a winding piece 4 is provided for the supply film chamber whereby the film may be re-wound thereinto, in a manner familiar to users of cameras of this type. A view finder 5 is provided as is also a suitable footage indicator 6, the details of which form no part of this invention.

The body 1 of the camera is provided internally and substantially centrally with a partition 7 provided with an opening 8 in alignment with the exposure area of the film and with the lens and shutter unit indicated generally at 9.

The lens and shutter unit 9 are suitably mounted upon the forwardly projecting end of a tubular hollow barrel-like support 10 projecting into the body of the camera in alignment with the opening 8 and having an enlarged flanged portion 11 adapted to engage against and be guided by the inner surface of the compartment formed within the side walls 1. The shoulder 12 provided by the enlarged flange portion 11 serves as an abut-

ment for one end of a coil spring 13, the opposite end of which engages against the partition 7, and the tendency of such spring is to normally urge the support 10 and the lens and shutter unit 9 thereon, outwardly but which, as shown clearly in Figure 4, is readily compressible when these elements are pushed inwardly.

Secured to the front of the camera 1 and encircling the lens and shutter unit 9 is a locking ring 14 fastened to the camera front in any suitable manner as by the screws 15. This ring is provided at a plurality of points around its inner circumference and directly adjacent the lens and shutter unit 9 with outwardly formed locking flanges 16 preferably formed out of the material of the ring itself, such flanges being bent at right angles to the ring 14 and thence inwardly at right angles towards the lens and shutter unit 9 as shown clearly in Figure 4. Three of these locking flanges have been shown but it will be obvious that two or more can be provided if desired.

Carried by the lens and shutter unit 9 is a locking ring 17 rigidly fixed to such unit. As is apparent from the drawings, the supporting unit 10, the lens and shutter unit 9, and the locking ring 17, are freely rotatable on the camera. The locking ring 17 is provided at a plurality of specified points, corresponding with the number of locking flanges 16, with outwardly extending locking fingers 18 which when the lens and shutter unit 9 and its support are pushed inwardly to the position shown in Figure 4, may be engaged beneath the locking flanges 16 as shown clearly in Figures 2, 3 and 4, whereby such lens and shutter unit with its support are secured in the innermost position shown in full lines in Figure 1, namely, out of operative position. By simply rotating the unit, the locking fingers 18 disengage from beneath the locking flanges 16 and permit the spring 13 to move the unit outwardly.

The shouldered portion 12 of the support 10 is provided at spaced intervals with lugs 19 which, when the unit assumes its outward position as just described, engage against the inner or rear surface of the locking ring 14, as shown clearly in Figure 8. In this position the lens and shutter unit are in the proper focal position for "long shots". If "close-ups" are desired, the unit 9 and support 10 may be rotated to bring the lugs 19 into registry with the locking flanges 16 whereupon the continued outward movement or adjustment of the unit 9 and support 10 is permitted by virtue of the lugs 19 moving into the recess formed in the locking plate 14 by the flanges 16, such lugs then engaging the undersides of the locking flanges 16. This is shown clearly in Figure 6 and constitutes the proper focal position of the unit for "close-ups".

It will be quite clear that from either of the two outwardly adjusted positions of the lens and shutter unit, the same may be pushed inwardly to the full line position shown in Figure 1, and turned to bring the locking fingers 18 beneath the locking flanges 16 for easy and convenient transportation. The sliding engagement between the flange 11 of the supporting member 10 and the interior wall of the camera body, plus a velvet or other lining 1a on the interior of the casing, provides a lock-tight connection whereby the only light capable of reaching the film in its exposure position in the camera is through the lens and through the supporting member 10.

Many changes may be made in details of con-

struction and arrangement of parts without departing from the spirit and scope of my invention. I do not limit myself, therefore, to the exact form herein shown and described other than by the appended claims.

I claim:

1. A camera comprising a casing having a hollow chamber, a lens and shutter unit, a support for said unit slidably mounted in said chamber and projecting outwardly from the same, means normally urging said support and unit outwardly, means on said support and cooperating with said casing for limiting the outward movement of said unit, and means on said support and cooperating with means on said casing for locking said unit and support in its inner position.

2. A camera comprising a casing having a hollow chamber, a lens and shutter unit, a support for said unit slidably mounted in said chamber and projecting outwardly therefrom, means normally urging said support and unit outwardly, means on said support and cooperating with means on said casing for limiting the outward movement of said unit and support to a plurality of predetermined focal positions, and means on said casing for locking said unit and support in its inner position.

3. A camera comprising a casing having a hollow chamber, a lens and shutter unit, a support for said unit slidably mounted in said chamber and projecting outwardly therefrom, means normally urging said support and unit outwardly, means on said support, and cooperating with means on said casing for limiting the outward movement of said unit and support to a plurality of predetermined focal positions, and means on said casing for locking said unit and support in its inner position, said last named means comprising a fixed locking ring on said casing having means overlying a flanged portion of said support.

4. A camera comprising a casing having a hollow chamber, a lens and shutter unit, a support for said unit slidably mounted in said chamber and projecting outwardly therefrom, means normally urging said support and unit outwardly, means on said support and cooperating with means on said casing for limiting the outward movement of said unit and support to a plurality of predetermined focal positions, and means on said casing for locking said unit and support in its inner position, said last named means comprising a fixed locking ring on said casing having means overlying a flanged portion of said support and said flanged portion having a plurality of levels for engaging said ring.

5. A camera comprising a casing having a hollow chamber, a lens and shutter unit, a support for said unit slidably mounted in said chamber and projecting outwardly therefrom, spring means normally urging said support and unit outwardly, a locking ring on said casing and having a flange overlying a flanged portion of said support, lugs formed outwardly on said ring at spaced points, a latch ring on said support having spaced fingers adapted to engage beneath said lugs and lock said unit and support in its inner position against the tension of said spring, said locking ring being engageable by the flanged portion of said support to limit the outward movement thereof.

6. A camera comprising a casing having a hollow chamber, a lens and shutter unit, a support for said unit slidably mounted in said chamber and projecting outwardly therefrom, spring

means normally urging said support and unit outwardly, a locking ring on said casing and having a flange overlying a flanged portion of said support, lugs formed outwardly on said ring at spaced points, a latch ring on said support having spaced fingers adapted to engage beneath said lugs and lock said unit and support in its inner position against the tension of said spring, said locking

ring being engageable by the flanged portion of said support to limit the outward movement thereof, and spaced lugs on said flanged portion of said support, registrable and engageable with the lugs on said locking ring to permit a plurality of outward focal positions of said support and unit.

CHARLES ALBERT VERSCHOOR,

Appendix B:

Bibliography and References

- Adams, Ansel, The Camera. Little, Brown, and Company, Boston, 1980.
- Burian, Peter K. and Caputo, Robert, National Geographic Photography Field Guide: Secrets To Making Great Pictures. National Geographic Book Division, Washington, D.C., 1999.
- Lahue, Kalton C. and Bailey, Joseph A., Glass, Brass, and Chrome: The American 35mm Miniature Camera. University of Oklahoma Press, Norman, Oklahoma, 1972.
- Tydings, Kenneth, The Argus 35mm Guide And Reference Book. Greenberg: Publisher, New York, 1952.

Advertisements

- “Ideal for Travel” International Research Corporation. Advertisement. The National Geographic Magazine May 1937.
- “Get High Precision At Low Cost...” International Research Corporation. Advertisement. Popular Photography Oct. 1938: 61.
- “Argus Scores Again!” International Research Corporation. Advertisement. Popular Photography Mar. 1939: 6.
- “Here’s your key to every Gift Problem!” Argus Industries Incorporated. Advertisement. Holiday Magazine Dec. 1946:138.

Other

- Verschoor, Charles A., “Photographic Camera.” US Patent 2052261. 25 Aug. 1936.
- Aim and Shoot: Argus Candid Camera Photography. Ann Arbor, MI: International Research Corporation.
- Argus Lens Accessory Kit. Ann Arbor, MI: International Research Corporation.
- Instructions For Operating Model A Argus Camera. Ann Arbor, MI: International Research Corporation.
- Instructions For Operating Model A2F Argus Camera. Ann Arbor, MI: International Research Corporation.
- “Antique Cameras And Repair Information.” Argus Camera. 2002. Argus Industries Inc. 15 Jan. 2003. <<http://www.arguscamera.com/antique.html>>.

Free Manuals Download Website

<http://myh66.com>

<http://usermanuals.us>

<http://www.somanuals.com>

<http://www.4manuals.cc>

<http://www.manual-lib.com>

<http://www.404manual.com>

<http://www.luxmanual.com>

<http://aubethermostatmanual.com>

Golf course search by state

<http://golfingnear.com>

Email search by domain

<http://emailbydomain.com>

Auto manuals search

<http://auto.somanuals.com>

TV manuals search

<http://tv.somanuals.com>