

Asanté FriendlyNET FS4016P 16-port Dual-speed Fast Ethernet Switch User's Guide

Product Introduction

Congratulations on your purchase of the Asanté FriendlyNET FS4016P. These switches were designed to give you the ultimate in performance, flexibility, ease-of-use, and reliability.

Your Asanté FriendlyNET FS4016P can increase performance on your network by bringing full Ethernet bandwidth to individual workgroups, or straight to the desktop, instead of requiring all stations to share the bandwidth of a single network. The switch's 100Mbps Fast Ethernet capability can eliminate bottlenecks in connections to servers, or can link 10Mbps workgroups to a 100Mbps Fast Ethernet network backbone.

For straight-through 10Base-T/100Base-TX connection to servers and workstations, the switch supports full-duplex connection, effectively doubling the total throughput on individual links. The switch's store-and-forward switching architecture forwards packets to their destination with a minimum of delay.

The switches can be placed on a tabletop or wall-mounted, and provide the ideal solution for your small, medium, or large Ethernet/Fast Ethernet network. It is designed to comply fully with the IEEE 802.3 Ethernet and 802.3u Fast Ethernet standards.

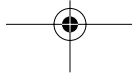
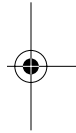
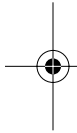



Asanté FriendlyNET FS4016P Installation Guide



Package Contents

1. Asanté FriendlyNET FS4016P 16-port 10/100M Switch
2. Self-adhesive rubber pads for desktop installation
3. AC Power cord
4. Rack Mounting kit for rack installation
5. Installation guide

If any of these items are missing, contact your dealer immediately

Installation

The Asanté FriendlyNET FS4016P switch is easy to install and requires no special training. You should, however, read the following instructions carefully before proceeding to install your switch. The diagram below shows the layout of the front and rear panels.

Front & Rear Panel of the Asanté FriendlyNET FS4016P

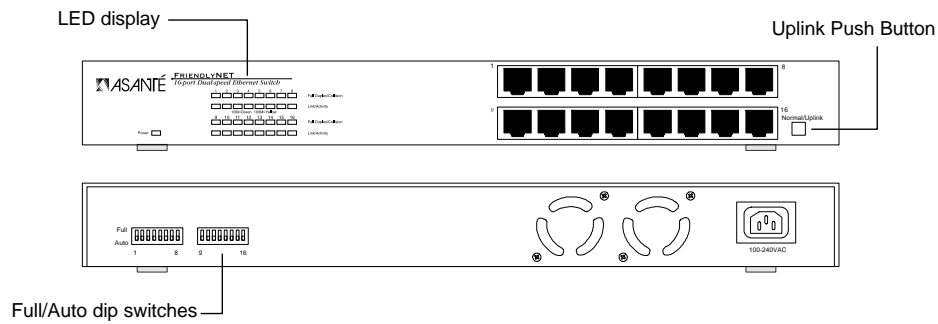

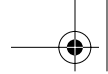

Asanté FriendlyNET FS4016P Installation Guide

The Asanté FriendlyNET FS4016P is designed for easy “plug and play” installation. Before you connect your switch to other devices, there are several issues you should keep in mind:

- △ When connecting the switch to a workstation using unshielded twisted pair cable, you must make sure that the cable length is not greater than 100 meters. 10Base-T twisted pair Ethernet cabling should be category 3 or better, and 100Base-TX twisted pair Fast Ethernet cabling should use tested category 5 cabling.
- △ Network cable segments can be connected to, or disconnected from the switch while the power is on. Plugging in or removing network cables while your switch is operating will not interrupt the operation of the switch.
- △ When placing your switch, you need to avoid dusty locations and electromagnetically noisy areas.

Desktop Placement

You can place the switch on a table. In this case, use the four self-adhesive feet, which are provided with the Asanté FriendlyNET FS4016P for cushioning purposes. Stick them on the four corners of the bottom surface of the switch, as shown in diagram below to cushion it against vibration.

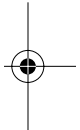
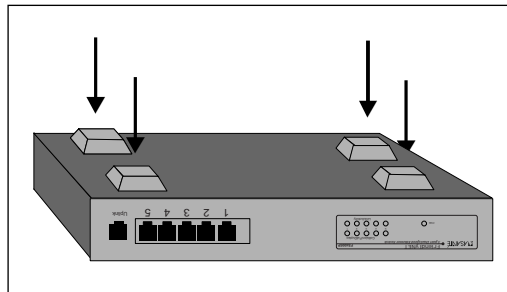



Asanté FriendlyNET FS4016P Installation Guide

Connecting to Servers and Workstations



Use the following procedure to connect a 10Base-T or 100Base-TX Ethernet server or workstation to the switch.

1. Make sure that the length of the straight-through cable between the switch and the station does not exceed 100 meters, including all patch cables and cross-connect wires.
2. Connect one end of the cable to the RJ-45 connector on the switch, and the other end to the station.

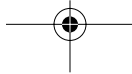
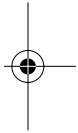
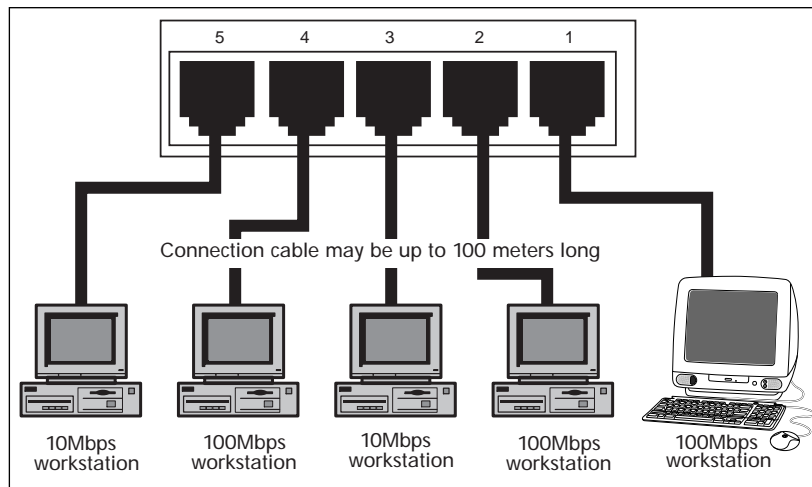

Using the Uplink connection

To connect a switch or hub, note the following:

1. One normal/uplink push button on the front panel allows users to select to connect to a PC or a hub/switch. The default setting is in the Normal (MDI-X) position, i.e. the out position. The port is configured to connect with a PC. When the push button is pressed in (MDI), it allows users to connect with a hub or a switch using straight-through twisted pair cable.

△ Use a straight-through cable to connect uplink port or use a crossover cable to connect to any port except uplink port. (Do not connect both uplink ports together, and do not use a crossover cable to connect with the uplink port).

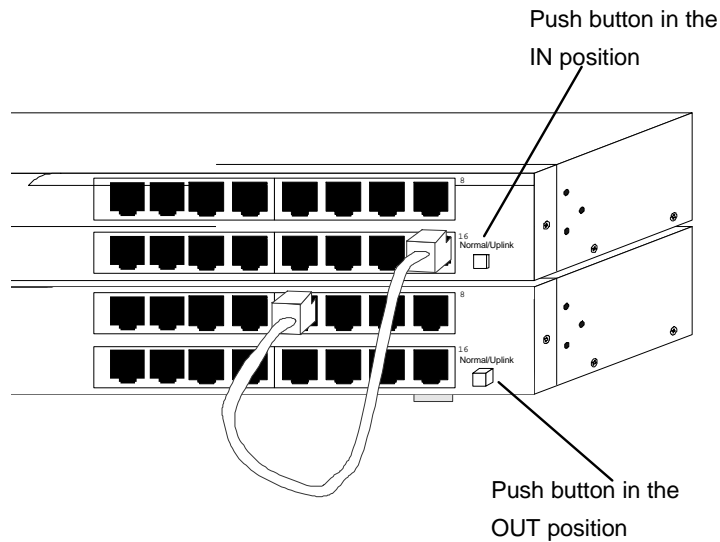



Asanté FriendlyNET FS4016P Installation Guide

LED Indicators

Front Panel LED Indicators

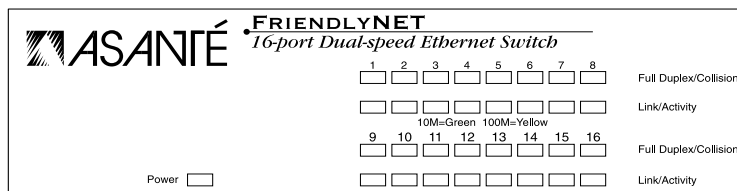

Table 1: Power LED

Color	Status
Green	The switch is powered on and ready for use
OFF	<p>The switch is powered off. Please check the following issues:</p> <ul style="list-style-type: none"> • Make sure the power adapter is properly inserted into the power connector on the switch. • Determine whether or not the power adapter is functional by plugging another device into the receptacle





Table 2: Link/Activity

Color	Status
Off	No link is established on the port.
Green	A 10Mbps Link is established on the port.
Blinking green	A 10Mbps Link is established and traffic is being received.
Yellow	A 100Mbps link is established on the port.
Blinking Yellow	A 100Mbps link is established and traffic is being received.

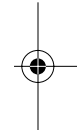
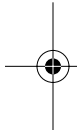
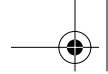

Table 3: Full Duplex/Collision

Color	Status
Off	There is no link. Or the port is operating in half-duplex mode.
Yellow	The port is operating in full-duplex mode.
Blinking Yellow	The port is in the half-duplex mode and a collision has occurred.





Asanté FriendlyNET FS4016P Installation Guide

Full/Auto Dip Switch

By default each port is capable of full autonegotiation. In addition, each port may be manually configured for full-duplex operation using the DIP switches on the rear panel of the switch.

△ If a port is configured for full-duplex operation, you must ensure that the link partner is also set for full duplex. Don't connect a hub to a port that is set for full duplex.

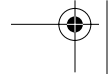
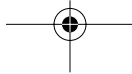
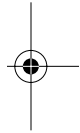
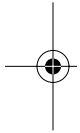
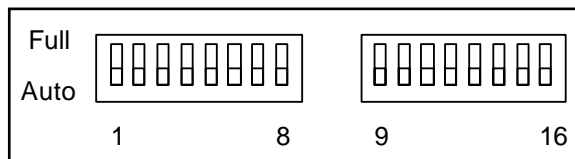



MOUNTING KIT INSTRUCTION

Asanté FriendlyNET FS4016P 16-port 10/100M Switch is supplied with two mounting brackets and six screws for mounting into a 19" rack.

Rack mounting in a 19" rack

1. Locate the mounting bracket over the mounting holes on each side of the switch.
2. Insert the screw through the bracket and into the bracket mounting holes in the switch.
3. Insert the unit into the 19-inch rack.

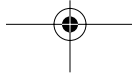
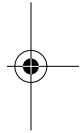
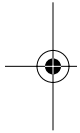
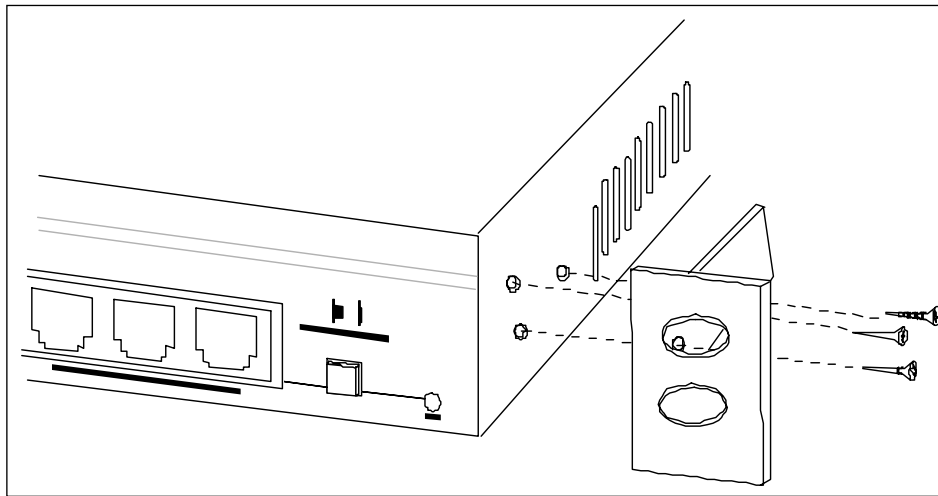

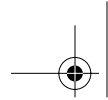

Asanté FriendlyNET FS4016P Installation Guide



TECHNICAL INFORMATION

StandardsSupported

IEEE802.3, IEEE802.3u, IEEE 802.3x

10/100Base-TX UTP/STP Port

16 N-WAY ports

Uplink port

Port #16

Cabling

UTP/STP Category 3, 4, 5 (100 ohm impedance)

Input voltage

100–240 Vac, 50/60Hz

Operating temperature

0–40° C (32–122° F)

Operating humidity

10–95%

Certification

FCC Class A and CE Class A

Dimensions

330mm (W) x 207mm (D) x 43mm (H)

13" (W) x 8.1" (D) x 1.6" (H)

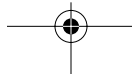
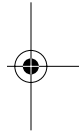
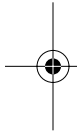

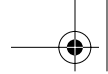

Contacting Technical Support

To contact Asanté Technical Support:

Telephone	(800) 622-7464
Fax	(801) 566-3787
E-mail	support@asante.com
World Wide Web Site	http://www.asante.com

Technical Support Hours

6:00 a.m. to 5:00 p.m. Pacific Standard Time USA, Monday - Friday.

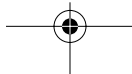
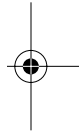
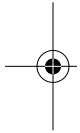

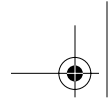

Asanté FriendlyNET FS4016P Installation Guide



ASANTÉ TECHNOLOGIES, INC., 821 FOX LANE, SAN JOSE, CA 95131

PHONE: 800.622.7464 • FAX: 801.566.3787 • e-mail address: sales@asante.com •
World Wide Web site: <http://www.asante.com>

©1999 Asanté Technologies Inc. Asanté is a trademark of Asanté Technologies, Inc.
All brand names and products are trademarks or registered trademarks of their respective holders.

March 1999 Rev A.



Free Manuals Download Website

<http://myh66.com>

<http://usermanuals.us>

<http://www.somanuals.com>

<http://www.4manuals.cc>

<http://www.manual-lib.com>

<http://www.404manual.com>

<http://www.luxmanual.com>

<http://aubethermostatmanual.com>

Golf course search by state

<http://golfingnear.com>

Email search by domain

<http://emailbydomain.com>

Auto manuals search

<http://auto.somanuals.com>

TV manuals search

<http://tv.somanuals.com>