

C2 COMPACT / C6 COMPACT



English
Deutsch
Français
Español
Italiano
Norsk



www.askproxima.com

TABLE OF CONTENTS

INHALTSVERZEICHNIS TABLE DES MATIÈRES INDICE INDICE INNHOLDSFORTEGNELSE

A. SUPPLIED MATERIAL..... 3 LIEFERUMFANG EQUIPEMENT FOURNI MATERIAL SUMINISTRADO MATERIALE FORNITO VEDLAGT MATERIELL	G. OVERVIEW..... 11 ÜBERSICHT PRESENTATION VISTA GENERAL PROSPETTO OVERSIKT
B. SETTING UP PROCEDURE..... 4 ANSCHLUSS INSTALLATION PROCEDIMIENTO DE CONEXIÓN PROCEDIMENTO DI IMPOSTAZIONE OPPSETT	H. MAINTENANCE..... 12 PFLEGE MAINTENANCE LIMPIEZA MANUTENZIONE VEDLIKEHOLD
C. START - STOP..... 5 START - STOP MISE EN/HORS SERVICE ENCENDIDO - APAGADO AVVIO - ARRESTO START - STOPP	I. LAMP REPLACEMENT..... 13 AUSTAUSCH DER LAMPE REPLACEMENT DE LA LAMPE SUSTITUCIÓN DE LA LÁMPARA SOSTITUZIONE DELLA LAMPADINA SKIFTE LAMPEN
D. IMAGE ADJUSTMENTS..... 6 BILDEINSTELLUNGEN MISE AU POINT DE L'IMAGE AJUSTE DE LA IMAGEN REGOLAZIONE DELL'IMMAGINE JUSTERE BILDET	J. SAFETY INSTRUCTIONS..... 14 SICHERHEITSHINWEISE INSTRUCTIONS DE SECURITE INSTRUCCIONES DE SEGURIDAD ISTRUZIONI SULLA SICUREZZA SIKKERHETSFORSKRIFTER
E. REMOTE CONTROL & KEYBOARD..... 7 FERNBEDIENUNG UND BEDIENFELD TELECOMMANDE ET CLAVIER CONTROL REMOTO Y TECLADO TELECOMANDO E TASTIERA FJERNKONTROLL OG TASTATUR	K. TECHNICAL DATA..... 18 TECHNISCHE DATEN CARACTERISTIQUES TECHNIQUES DATOS TÉCNICOS DATI TECNICI TEKNISKE DATA
F. MENU ADJUSTMENTS..... 9 MENÜEINSTELLUNGEN OPTIONS DE MENU MENÚ DE AJUSTES IMPOSTAZIONI DAL MENU MENYINNSTILLINGER	L. FCC STATEMENT..... 20
	M. SERVICE INFORMATION..... 21

A

SUPPLIED MATERIAL

LIEFERUMFANG EQUIPEMENT FOURNI MATERIAL SUMINISTRADO MATERIALE FORNITO VEDLAGT MATERIELL

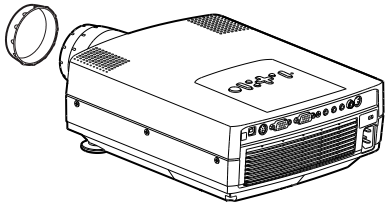

LCD Projector with lenscap
LCD Projektor mit Schutzkappe
Projecteur LCD avec protection lentille
Proyector LCD con tapa del lente
Proiettore LCD con coperchietto
LCD-projektor med linsedeksel



Remote control
Fernbedienung
Télécommande
Control remoto
Telecomando
Fjernkontroll

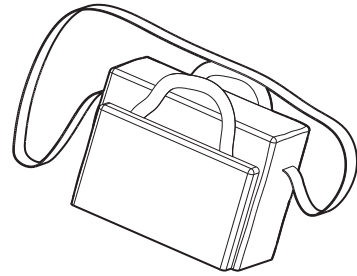

Soft Case
Soft-Tragetasche
Etui souple
Funda
Valigetta
Myk veske



Batteries for remote control
Batterien für Fernbedienung
Piles pour la télécommande
Baterías para el control remoto
Pile per il telecomando
Batterier til fjernkontroll

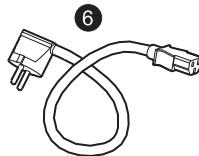

Power cord
Netzkabel
Cordon d'alimentation
Cable de alimentaciòn
Cavo alimentazione
Strømledning

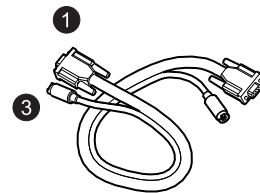

Computer & Mouse Cable
Computer- & Mauskabel
Câble d'ordinateur et souris
Conexión para computador y raton
Cavo computer e mouse
Data- & muskabel

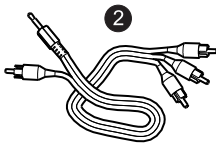

Video Cable
Videokabel
Câble vidéo
Conexión de vídeo
Cavo video
Videokabel

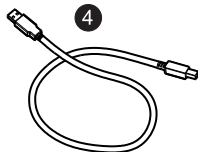

USB Mouse Cable
USB Mauskabel
Cable souris USB
Cable raton USB
Cavo mouse USB
USB Muskabel

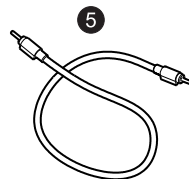

Audio Cable
Audio Kabel
Câble audio
Cable de audio
Cavo audio
Audiokabel



SCART adapter
SCART-Anschluß
Adaptateur audio
Adaptador de Scanner
Presa scart
SCART-adapter

*) Country dependent Länder abhängig Dépendant du pays Dependende del país Dipendentemente al paese di destinazione Område avhengig

C2 COMPACT / C6 COMPACT

3

www.askproxima.com

B

SETTING UP PROCEDURE

ANSCHLUSS INSTALLATION PROCEDIMIENTO DE CONEXIÓN PROCEDIMENTO DI IMPOSTAZIONE OPPSETT

1. Connect the projector to:
 - the data source with the Computer Cable (1)
 - the video source with the Video Cable (2)
2. For mouse control use:
 - the PS/2 mouse cable (3) attached to (1) or
 - the USB mouse cable (4)
3. For computer sound connection, use the audio cable (5)
4. Connect power cord to projector (6)
5. Turn on the projector, then the source(s)

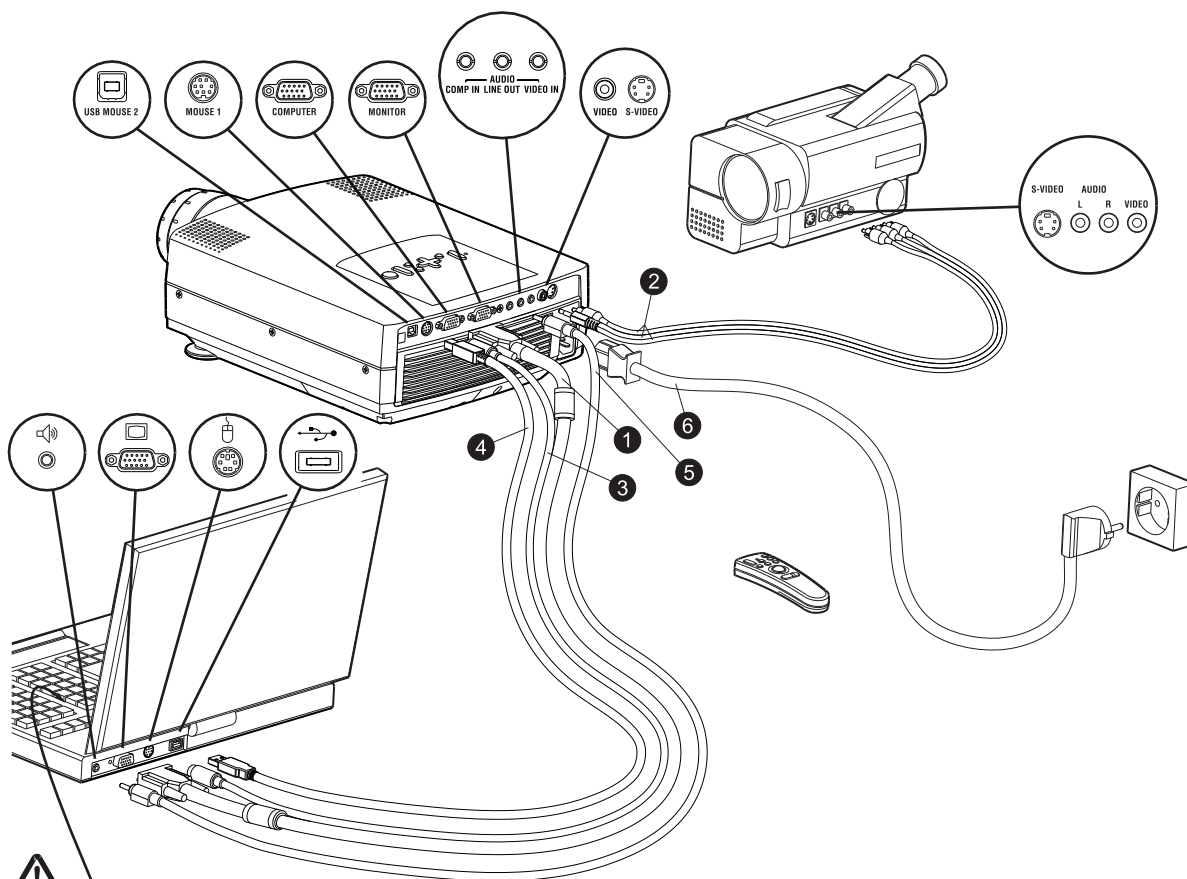

Switch to external monitor
Schalter für externen Monitor
Commutateur pour écran autonome
Enchufe para monitor externo
Interruttore per monitor esterno
Bytt til ekstern skjerm



C2 COMPACT / C6 COMPACT

4

www.askproxima.com

C

START - STOP

START - STOP MISE EN/HORS SERVICE ENCENDIDO - APAGADO AVVIO - ARRESTO START - STOPP



Install batteries
Batterien einlegen
Mettre des piles en place
Colocar las baterías
Inserimento pile
Sett inn batteriene

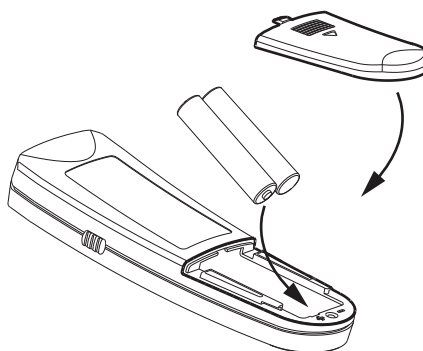

Switch ON to
operate remote
control

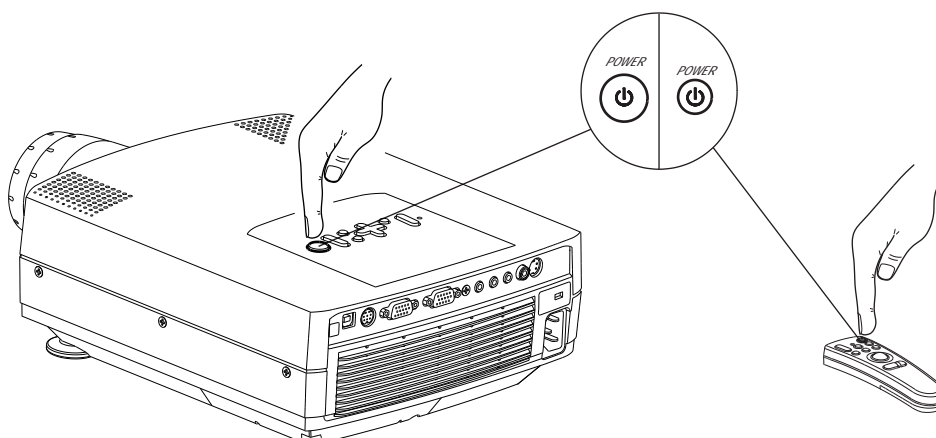
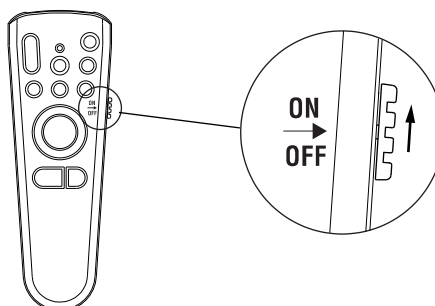

C2 COMPACT / C6 COMPACT

5

www.askproxima.com

D

IMAGE ADJUSTMENT

BILDEINSTELLUNG MISE AU POINT DE L'IMAGE AJUSTE DE LA IMAGEN REGOLAZIONE DELL'IMMAGINE JUSTERE BILDET

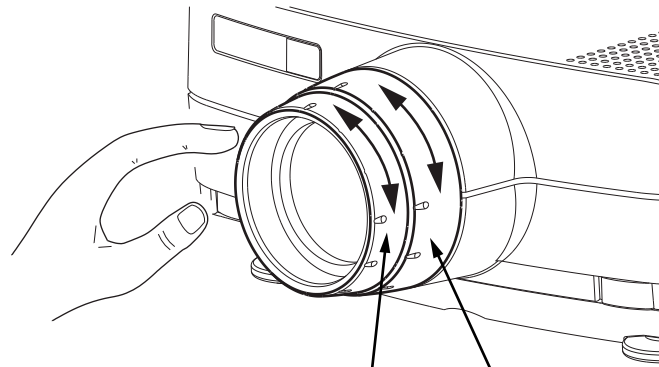

Zoom: adjusts picture size
Focus: adjusts picture clearness

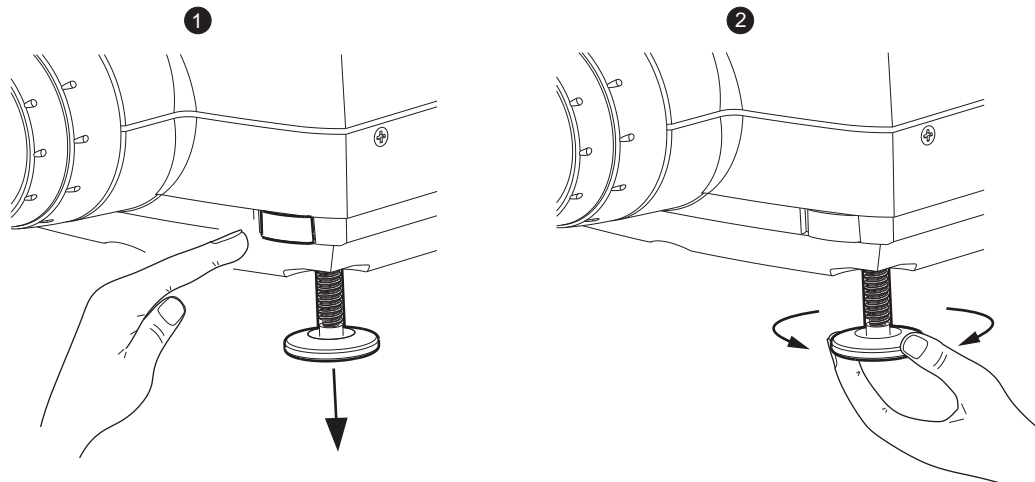

Release projector feet to adjust display angle (1) or manually adjust feet (2)



REMOTE CONTROL & KEYBOARD

FERNBEDIENUNG UND BEDIENFELD
TELECOMMANDE ET CLAVIER CONTROL REMOTO Y TECLADO TELECOMANDO E TASTIERA FJERNKONTROLL OG TASTATUR

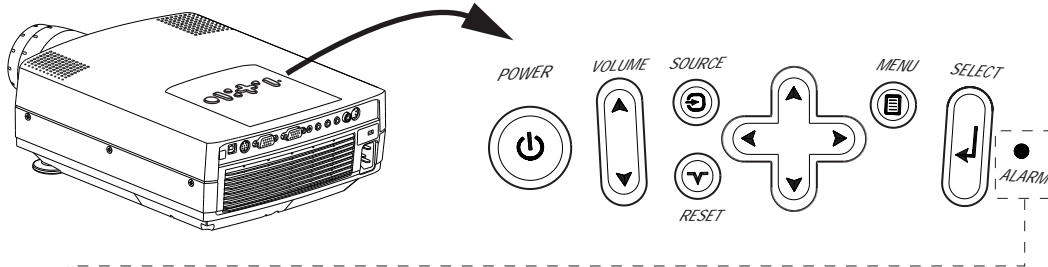

RED light indicates lamp replacement required. Ref. 1 (LAMP REPLACEMENT)
Das ROTE Licht zeigt an, daß die Lampe ausgewechselt werden muß. Ref. 1 (AUSTAUSCH DER LAMPE)
La lumière ROUGE indique que la lampe doit être remplacée. Ref. 1 (REPLACEMENT DE LA LAMPE)
La luz ROJA indica que se debe de reemplazar la bombilla. Ref. 1 (SUSTITUCIÓN DE LA LÁMPARA)
La luce ROSA indica che bisogna sostituire la lampadina. Ref. 1 (SOSTITUZIONE DELLA LAMPADINA)
RØDT lys angir at lampen må byttes ut. Ref. 1 (SKIFTE LAMPEN)



RED FLASHING when the projector is overheated. Power off and let cool down
ROTES BLINKLICHT zeigt Überhitzung des Projektors an. Ausschalten und abkühlen lassen
Un CLIGNOTEMENT ROUGE signale la surchauffe du projecteur. Débrancher l'alimentation et laisser refroidir
LUZ ROJA PARPADEANTE cuando el proyector está sobrecalentado. Desconectar la alimentación y dejar enfriar
La luce ROSSA INTERMITTENTE indica che il proiettore si è surriscaldato. Scollegare l'alimentazione e lasciare raffreddare
RØDT BLINKENDE når projektoren er overopphetet. Slå av og la projektoren avkjøle seg.

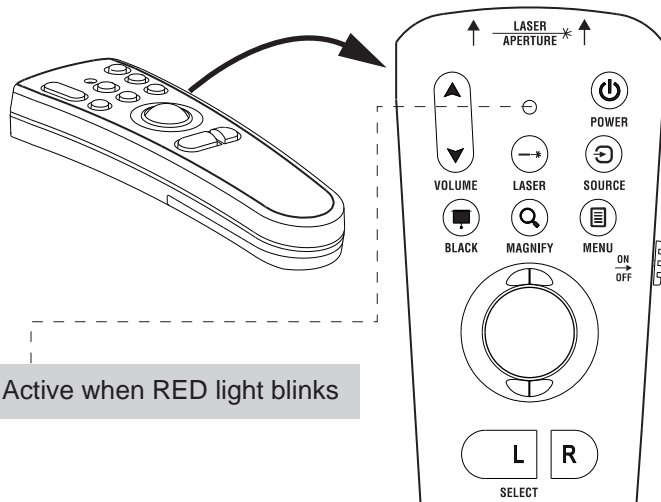

Active when RED light blinks



LASER RADIATION
DO NOT STARE INTO BEAM
CLASS 2 LASER PRODUCT

Wavelength 670 nm.
Max. output <1 mW.
EN60825-1, Am. 11.

C2 COMPACT / C6 COMPACT

7

www.askproxima.com

REMOTE CONTROL & KEYBOARD

FERNBEDIENUNG UND BEDIENFELD

TELECOMMANDE ET CLAVIER CONTROL REMOTO Y TECLADO TELECOMANDO E TASTIERA FJERNKONTROLL OG TASTATUR

- Activate by pressing actual key(s).
- Zum Aktivieren jeweilige Taste(n) drücken.
- Activer en pressant la (les) touches correspondante(s).

- Activar pulsando la(s) tecla(s) indicativa(s).
- Attivare premendo il / i tasto / i attivi.
- Aktiver ved å trykke på aktuell(e) tast(er).

Turn the projector ON/OFF

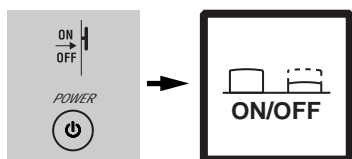

Adjust volume

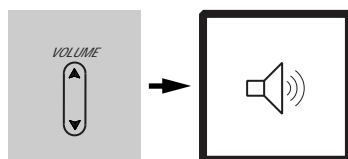

Blackens the projected image

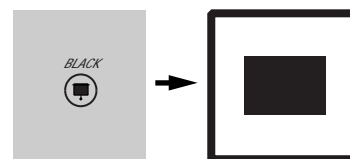

Switch between connected sources

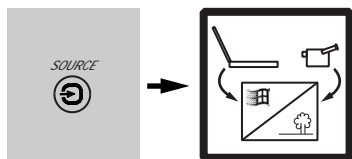

Synchronizes the projector settings to the active source

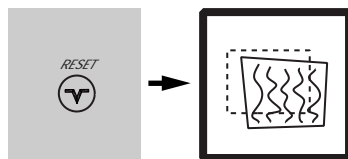

Activates/deactivates on screen menu

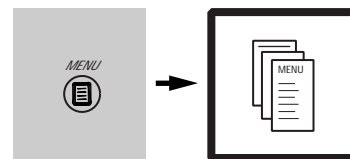

Scroll menu and select on-screen menu function

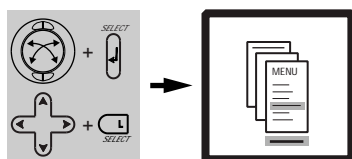

Mouse control

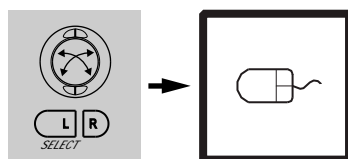

Laser pointer

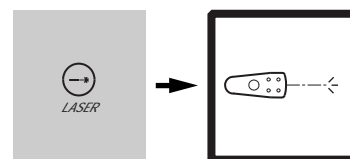

Choose area to magnify

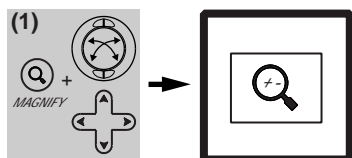

Use trackball/arrows to magnify

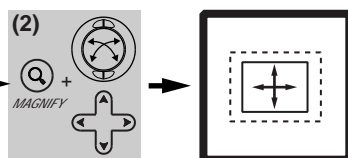

Reset picture to full size

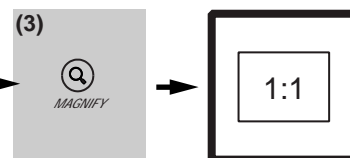



MENU ADJUSTMENTS

MENÜEINSTELLUNGEN OPTIONS DE MENU MENÙ DE AJUSTES IMPOSTAZIONI DAL MENU MENYINNSTILLINGER

Activate/deactivate by:
Aktivieren/Deaktivieren mit:
Activer et désactiver à l'aide:
Activar/desactivar pulsando:
Attivare/disattivare premendo:
Aktiver/deaktivir med:



Navigate by:
Steuern mit:
Pour naviguer:
Navegar pulsando:
Spostarsi premendo:
Naviger med:



Choose function with:
Funktion wählen mit:
Choisissez la fonction avec:
Seleccionar función con:
Scegliere la funzione con:
Velg funksjon med:

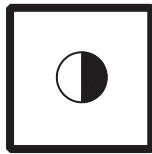
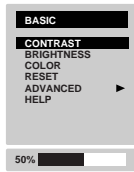

Adjusts contrast range from 0 to 100

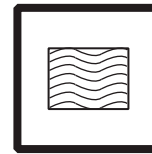

Adjusts horizontal phase/fine tunes image

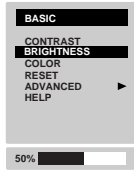

Adjusts brightness range from 0 to 100

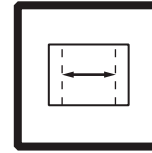
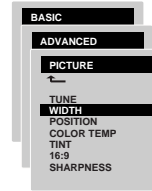

Adjusts width to image size

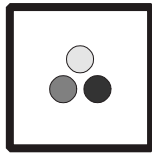

Adjusts colour intensity

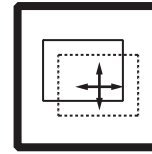
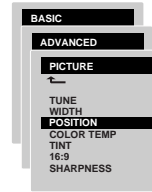

Adjusts position to image size

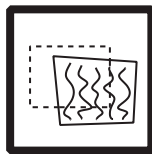
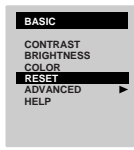

Synchronizes the projector settings to the active source

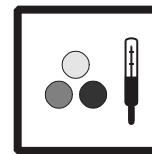
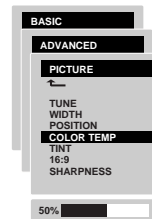

Modifies colour temperature balance

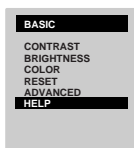

Indicates information about active source

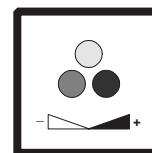
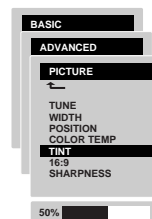

Varies the hue in video images

MENU ADJUSTMENTS

MENÜEINSTELLUNGEN OPTIONS DE MENU MENÙ DE AJUSTES IMPOSTAZIONI DAL MENU MENYINNSTALLINGER

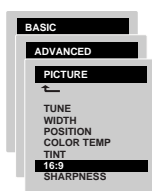

Select 16:9 image format

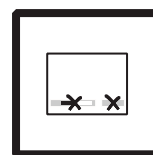
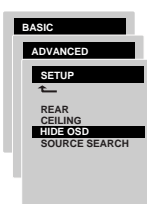

Select to hide On-Screen Display

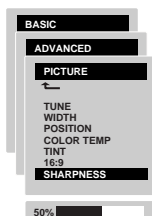

Adjust sharpness

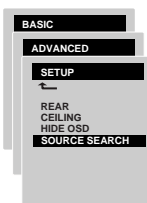

Select to activate/deactivate automatic source search



Select language

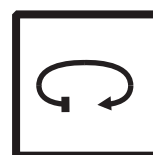
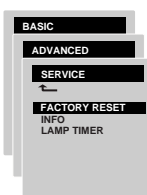

Select to reset all options to factory settings

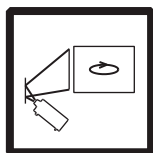
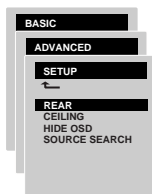

Select for rear projection

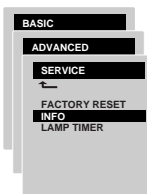

Select to display service information

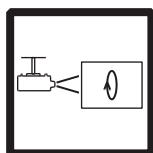
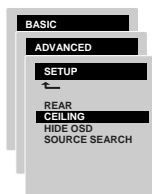

Select for ceiling mounted projection

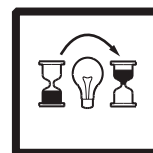
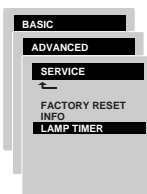

Select to reset lamp timer after lamp replacement (Ref. I)



OVERVIEW

BESTANDTEILE PRESENTATION VISTA GENERAL PROSPETTO OVERSIKT

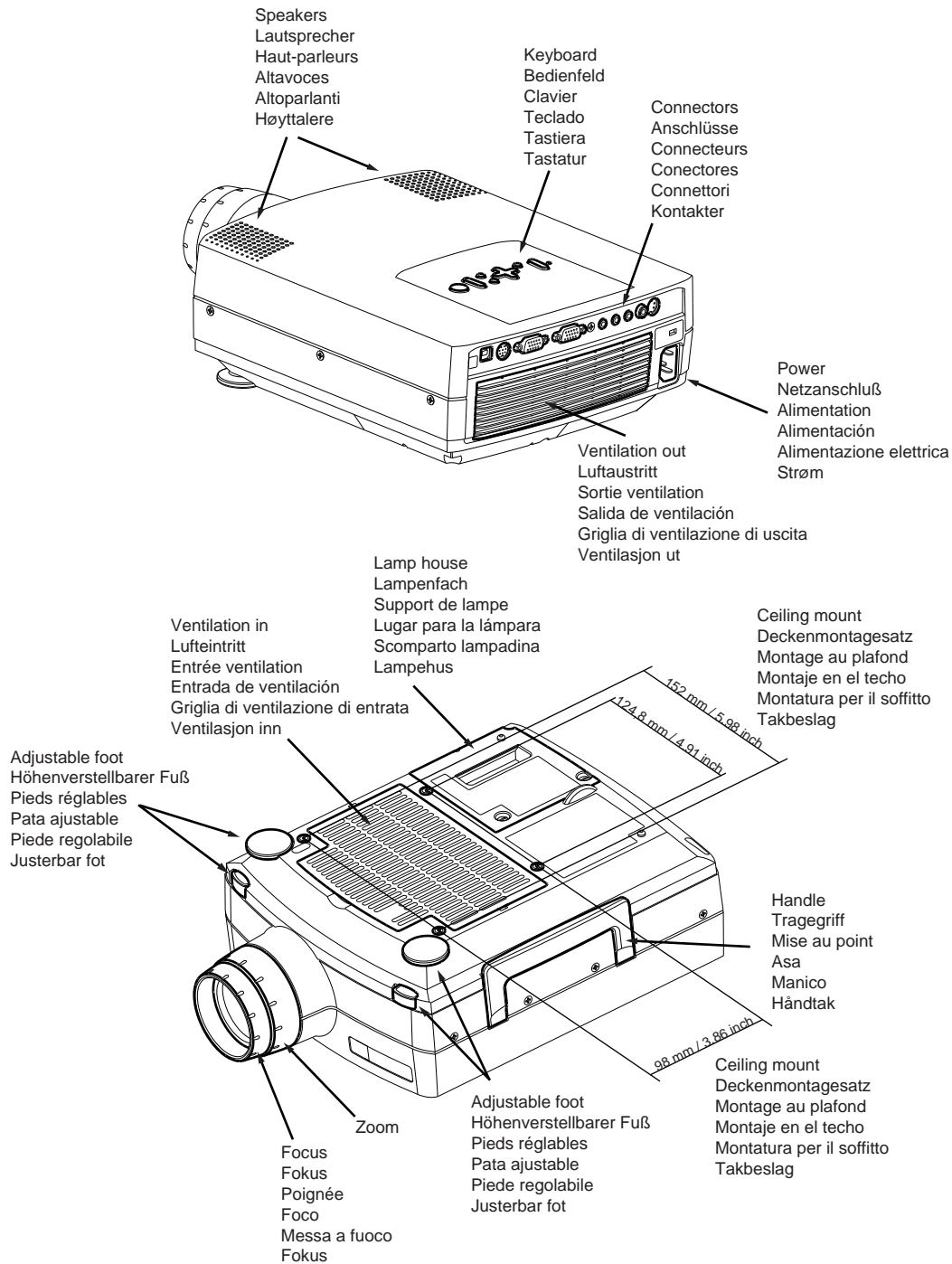

C2 COMPACT / C6 COMPACT



MAINTENANCE

PFLEGE MAINTENANCE LIMPIEZA MANUTENZIONE VEDLIKEHOLD

1. Remove bottom lid to access the filter (fig. 1a & 1b)
2. Clean filter (fig. 2)
3. Replace clean filter and close bottom lid (fig. 3)
4. Clean filter regularly for sufficient air flow

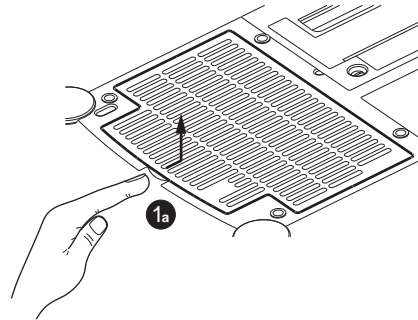

Damp cloth only
Nur feucht abwischen
Linge humide uniquement
Usar sólo un paño húmedo
Usare solo un panno umido
Kun fuktig klut

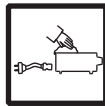

Disconnect power
Netzstecker ziehen
Débrancher l'alimentation
Desconectar la alimentación
Disinserire la spina
Trek ut strømledningen

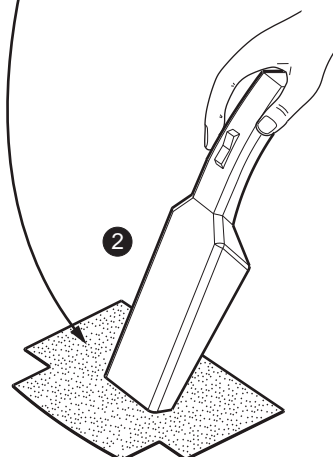
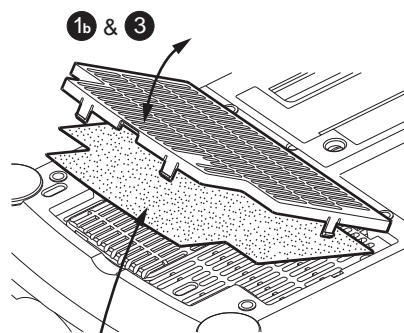
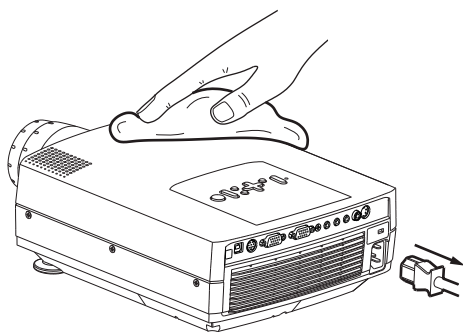
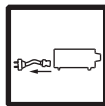

C2 COMPACT / C6 COMPACT

12

www.askproxima.com

LAMP REPLACEMENT

AUSTAUSCH DER LAMPE REMPLACEMENT DE LA LAMPE
SUSTITUCIÓN DE LA LÁMPARA SOSTITUZIONE DELLA LAMPADINA SKIFTE LAMPEN



Change lamp when lifetime expired. Replace expired lamp only with same type and rating
Wechseln Sie die Lampe nach Ablauf ihrer Lebensdauer aus. Nur Lampen des gleichen Typs und gleicher Stärke verwenden
Remplacer la lampe à la fin de sa durée de vie nominale. Ne remplacer la lampe que par un élément de type et puissance identiques
Sustituya la lámpara cuando esté gastada. Sustituya la lámpara gastada sólo por otra del mismo tipo y características
Sostituire la lampadina quando è scarica. Fornita esclusivamente con una lampadina dello stesso tipo e con la stessa potenza
Skift lampe når levetiden er overskredet. Bruk kun lampe av samme type og med samme effekt



Disconnect power
Netzstecker ziehen
Débrancher l'alimentation
Desconectar la alimentación
Disinserire la spina
Trek ut strømledningen



Reset lamp timer
Zähler auf Null setzen
Réinitialiser le compteur de lampe
Poner a cero el temporizador de la lámpara
Azzerare il timer della lampadina
Tilbakestill telleverket for lampen



1. Open screws on lamp housing
2. Pull out lamp housing
3. Insert new lamp housing
4. Tighten screws
5. Check filter pad (Ref. H)

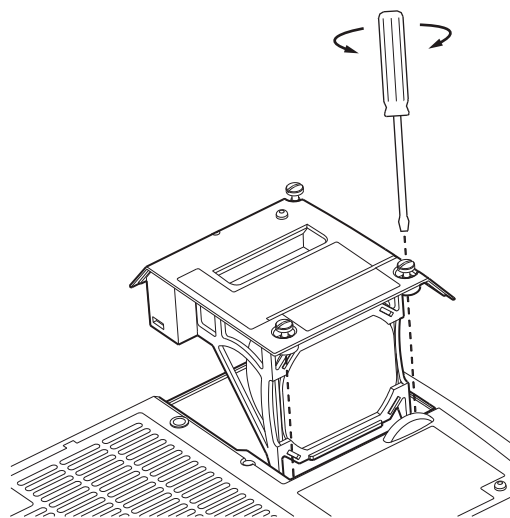
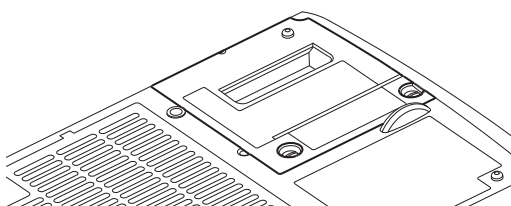

Refer service to qualified personnel only
Reparaturen sind von Fachpersonal durchzuführen
Confier toute intervention à un professionnel qualifié
La asistencia técnica debe realizarse por personal cualificado
Eventuali riparazioni devono essere effettuate esclusivamente da personale qualificato
All service må overlates til kvalifisert personell



**J**

SAFETY INSTRUCTIONS

INSTRUCCIONES DE SEGURIDAD

ISTRUZIONI SULLA SICUREZZA

SICHERHEITSHINWEISE

INSTRUCTIONS DE SECURITE

SIKKERHETSFORSKRIFTER



- Read instructions carefully before installation and use
- Vor Verwendung Gebrauchsanweisung sorgfältig lesen
- Lire attentivement les instructions avant de mettre en service et d'utiliser
- Lea atentamente las instrucciones antes de instalar y utilizar
- Leggere attentamente le istruzioni prima dell'installazione e dell'uso
- Les forskriftene omhyggelig før installering og bruk

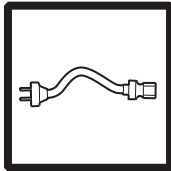

- Use only original cables
- Nur Originalkabel verwenden
- Utiliser exclusivement des câbles d'origine
- Use únicamente cables y conexiones originales
- Usare esclusivamente cavi originali
- Bruk kun originale kabler



- Expired lamp may explode!
- Abgelaufene Lampen können platzen!
- Une lampe périmée risque de provoquer une explosion!
- Las lámparas gastadas pueden explotar!
- La lampadina scarica può esplodere!
- Lampen kan eksplodere hvis levetiden er overskredet!

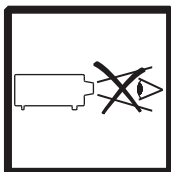

- Do not look into projection lens
- Nicht in die Linse sehen
- Ne pas regarder dans l'optique de projection
- No mire directamente hacia el haz luminoso del proyector
- Non guardare nella lente di proiezione
- Ikke se direkte på projektorlinsen

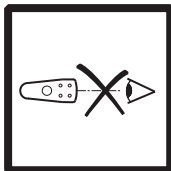

- Do not look into laser beam
- Nicht in den Laserstrahl sehen
- Ne pas regarder le faisceau laser
- No mire directamente hacia el haz luminoso del láser
- Non guardare nel raggio laser
- Ikke se direkte inn i laserstrålen



SAFETY INSTRUCTIONS

INSTRUCCIONES DE SEGURIDAD ISTRUZIONI SULLA SICUREZZA

SICHERHEITSHINWEISE INSTRUCTIONS DE SECURITE
SIKKERHETSFORSKRIFTER



- Avoid all kinds of moisture
- Vor Nässe schützen
- Protéger contre l'humidité
- Evite todo tipo de humedad
- Evitare di bagnare l'unità
- Unngå alle typer fuktighet



- To avoid personal injury, use on stable, hard surface
- Um Verletzungen zu vermeiden, nur auf stabile, harte Oberfläche stellen
- Poser sur un support stable et rigide afin de prévenir tout risque de dommage corporel
- Pare evitar daños personales coloque el equipo sobre una superficie dura y estable
- Per evitare lesioni personali, collocare il proiettore su una superficie stabile e rigida
- Brukes på stabil, hard overflate for å unngå personskade

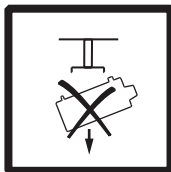

- To avoid personal injury, use only approved ceiling mount.
- Um Verletzungen zu vermeiden, nur autorisierte Deckenaufhängungen verwenden
- Utiliser exclusivement une fixation plafonnrière agréée afin de prévenir tout risque de dommage corporel
- Para evitar daños personales, utilice únicamente el dispositivo de montaje en techo homologado
- Per evitare lesioni personali, utilizzare esclusivamente supporti per il montaggio al soffitto approvati
- Bruk kun godkjent beslag for takmontasje for å unngå personskade

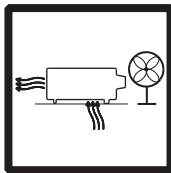

- Ensure free airflow for proper cooling
- Lüftungsschlitze des Gerätes freihalten
- Veiller à ce que le débit d'air soit linéaire afin d'assurer un refroidissement suffisant
- Verifique la libre circulación del aire de ventilación
- Non tappare le griglie di ventilazione per permettere un corretto raffreddamento
- Pass på fri luftgjennomstrømning for tilstrekkelig avkjøling



- Keep away from heat
- Von Hitze fernhalten
- Tenir éloigné de la chaleur
- Manténgalo alejado de fuentes de calor
- Mantenere lontano da fonti di calore
- Unngå sterk varme



SAFETY INSTRUCTIONS

INSTRUCCIONES DE SEGURIDAD ISTRUZIONI SULLA SICUREZZA

SICHERHEITSHINWEISE INSTRUCTIONS DE SECURITE
SIKKERHETSFORSKRIFTER

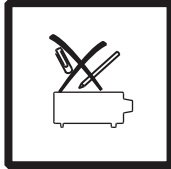

- Avoid object and liquid into projector
- Keine Gegenstände und Flüssigkeiten in den Projektor gelangen lassen
- Protéger le projecteur contre toute pénétration d'objets et de liquides
- Evite la entrada de objetos y líquidos dentro del proyector
- Non introdurre né oggetti né liquidi nel proiettore
- Unngå å få gjenstander eller væsker i projektoren

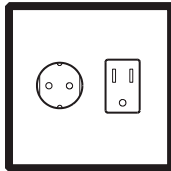

- Connect only with correct grounding and within power specification
- Nur an geerdeten Steckdosen mit angemessener Stromstärke anschließen
- Ne connecter qu'avec une bonne mise à la terre, sur une source électrique conforme à la spécification
- Conectar sólo en enchufes con toma de tierra y la alimentación especificada
- Effettuare i collegamenti esclusivamente con la corretta messa a terra e nel rispetto delle specifiche elettriche
- Tilkobling bare med riktig jording og innenfor spenningsangivelsene

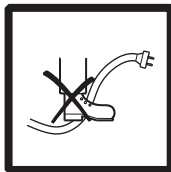

- Protect power cord from damage.
- Netzkabel vor Beschädigung schützen
- Protéger le cordon d'alimentation contre les dommages
- Proteja el cable de alimentación de posibles daños
- Proteggere il cavo di alimentazione elettrica da possibili danni
- Beskytt strømledningen mot skade

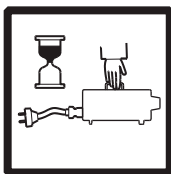

- Leave unit to cool down before moving
- Gerät vor dem Abtransport abkühlen lassen
- Laisser le projecteur refroidir avant le transport
- Deje enfriar el equipo antes de moverlo
- Fare raffreddare l'unità prima di trasportarla
- La enheten kjøle seg ned før den flyttes

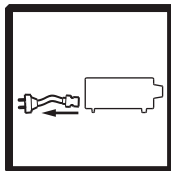

- Disconnect power when not in use for longer periods
- Netzstecker ziehen, wenn längere Zeit außer Betrieb
- Débrancher le cordon d'alimentation en cas d'inutilisation prolongée
- Desconecte la alimentación cuando no vaya a utilizarlo en un periodo de tiempo largo
- Disinserire la spina quando il proiettore non viene usato per periodi di tempo prolungati
- Trekk ut strømledningen når enheten ikke skal brukes på lengre tid



SAFETY INSTRUCTIONS

INSTRUCCIONES DE SEGURIDAD

ISTRUZIONI SULLA SICUREZZA

SICHERHEITSHINWEISE

INSTRUCTIONS DE SECURITE

SIKKERHETSFORSKRIFTER

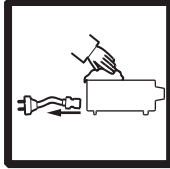

- Disconnect power when cleaning. Always clean dry or damp, never wet
- Vor dem Reinigen Netzstecker ziehen. Nur trocken oder feucht abwischen, nie naß
- Débrancher le cordon d'alimentation avant de nettoyer. Le linge de nettoyage doit être sec ou humide, en aucun cas détrempé
- Desconecte la alimentación antes de limpiarlo. Use un paño seco o ligeramente humedecido, nunca mojado
- Disinserire la spina durante la pulizia. Pulire sempre con un panno asciutto o umido, ma mai bagnato
- Trekk ut strømledningen ved rengjøring. Bruk alltid tørr eller fuktig klut, aldri våt

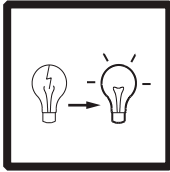

- Replace expired lamp only with same type and rating. Qualified personnel only!
- Nur lampen des gleichen Typs und gleicher Stärke verwenden. Nur durch Fachpersonal!
- Ne remplacer la lampe que par un élément de type et puissance identiques. Personnel qualifié uniquement!
- Sustituya la lámpara gastada sólo por otra del mismo tipo y características. Sólo personal cualificado!
- Sostituire la lampadina fornita esclusivamente con una lampadina dello stesso tipo e con la stessa potenza. Solo personale qualificato!
- Når lampen må skiftes, bruk lampe av samme type og med samme effekt. Må kun utføres av kvalifisert personell!

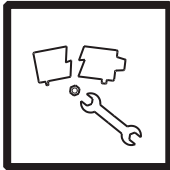

- Return unit for service if broken or otherwise does not work
- Gerät bei Beschädigung oder sonstigen Störungen an Kundendienst einreichen
- Renvoyer au S.A.V. en cas de dommages physiques ou d'anomalie de fonctionnement
- Envíe el equipo al Servicio de Asistencia Técnica si se estropea
- Rendere l'unità al servizio riparazioni nel caso in cui sia rotta o non funzioni correttamente
- Returner enheten for service hvis den er skadet eller ikke virker som den skal

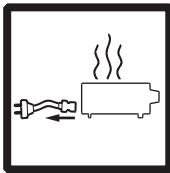

- Disconnect power if abnormal smell or smoke appears. Return for service
- Bei anomalen Gerüchen oder Rauchbildung Netzstecker ziehen. Kundendienst verständigen
- Si le projecteur dégage une mauvaise odeur ou de la fumée, débrancher le cordon d'alimentation et renvoyer au S.A.V.
- Desconecte la alimentación si aparece humo u olores raros. Envíelo al Servicio de Asistencia Técnica
- Disinserire la spina se si avverte un odore insolito o se fuoriesce fumo dall'unità. Rendere l'unità al servizio riparazioni
- Trekk ut strømledningen hvis du merker unormal lukt eller røyk. Returner enheten for service

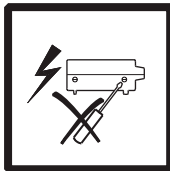

- Do not open unit. Risk of electric shock. Refer service to qualified personnel only
- Gerät nicht öffnen. Gefahr des Stromschlags. Reparaturen sind von Fachpersonal durchzuführen
- Risque d'électrocution: ne pas ouvrir le coffret. Confier toute intervention à un professionnel qualifié
- No abra el equipo. Existe riesgo de sufrir una descarga eléctrica. La asistencia técnica debe realizarse por personal cualificado
- Non aprire l'unità. Pericolo di scosse elettriche. Eventuali riparazioni devono essere effettuate esclusivamente da personale qualificato
- Enheten må ikke åpnes. Risiko for elektrisk sjokk. All service må overlates til kvalifisert personell

C2 COMPACT / C6 COMPACT

17

www.askproxima.com



TECHNICAL DATA

TECHNISCHE DATEN CARACTERISTIQUES TECHNIQUES DATOS TÉCNICOS DATI TECNICI TEKNISKE DATA

GENERAL CONDITIONS	ALLGEMEINE DATEN	ENVIRONNEMENT	CONDICIONES GENERALES	CONDIZIONI GENERALI	GENERELLE KRAV	
Storage temperature, sea level	Lagertemperatur, Meeresspiegel	Température de stockage au niveau de la mer	Temperatura de almacenamiento, a nivel del mar	Temperatura di conservazione, a livello del mare	Temperatur ved lagring, havflaten	-20 – 60 °C -4– 140 F
Storage humidity, non-condensing	Lagerfeuchtigkeit, nicht kondensierend	Humidité de stockage, sans condensation	Humedad relativa de almacenamiento sin condensación	Umidità di conservazione, senza condensa	Fuktighet ved lagring, ikke-kondenserende	10– 90 % RH
Operating temperature ambient, sea level	Raumtemperatur für Betrieb, Meeresspiegel	Température ambiante de fonctionnement au niveau de la mer	Temperatura ambiente de funcionamiento, a nivel del mar	Temperatura di funzionamento ambiente, a livello del mare	Romtemperatur ved bruk, havflaten	5– 35 °C 41– 95 F
Operating humidity	Betriebsfeuchtigkeit	Humidité de fonctionnement	Humedad relativa de funcionamiento	Umidità di funzionamento	Fuktighet ved bruk	20– 80 % RH

PROJECTOR UNIT	PROJEKTOR/GERÄT	PROJECTEUR	PROYECTOR	UNITÀ DEL PROIETTORE	PROJEKTOR-ENHETEN	
Dimensions (HxWxL)	Maße (HxBxL)	Encombrement (HxPxL)	Dimensiones (Alto x Ancho x Largo)	Dimensioni (Alt. x Largh. x Lungh.)	Størrelse (HxBxL)	99x236x282mm (347 incl. lens) 3.9x9.3x11.1 inch (13.7 incl. lens)
Weight	Gewicht	Poids	Peso	Peso	Vekt	3.7kg/8.1lbs.
Projection lens	Linse	Objectif de projection	Lente de proyección	Lente di proiezione	Projeksjonslinse	1.3 zoom ratio f=38-50mm F=1.8-2.1
Projection distance	Projektionsabstand	Distance de projection	Distancia de proyección	Distanza di proiezione	Projeksjons-avstand	1.1-10m 3.6-32.5 ft
Keystone correction	Trapezentzerrung	Compensation de distorsion trapézoïdale	Corrección de la clave	Correzione della deformazione	Keystone-korreksjon	10 degrees
Projection lamp	Projektionslampe	Lampe de projection	Lámpara para proyección	Lampadina di proiezione	Projeksjonslampe	120 W UHP
Light output	Lichtleistung	Puissance de clairément	Potencia luminosa	Erogazione luminosa	Lysstrøm	SVGA: 800 ANSI lumen XGA: 900 ANSI lumen
Light valve	Lichtverstärker-Röhre	Valeur lumineuse	Diafragma	Rele ottico	Lysrør	3x0.9 inch polysilicon TFT LCD
Colors	Farben	Couleurs	Colores	Colori	Farger	16.7 MILLION
Contrast	Kontrast	Contraste	Contraste	Contrasto	Kontrast	300:1
Pixels	Auflösung	Résolution	Pixels	Pixel	Piksler	SVGA: 800x600x3 XGA: 1024x768x3



Subject to change

Änderungen vorbehalten

Sous réserve de modifications

Sujetos a posibles cambios

Soggetti a modifica

Kan endres

C2 COMPACT / C6 COMPACT

18

www.askproxima.com

TECHNICAL DATA

TECHNISCHE DATEN CARACTERISTIQUES TECHNIQUES DATOS TÉCNICOS DATI TECNICI TEKNISKE DATA

PROJECTOR UNIT	PROJEKTOR/ GERÄT	PROJETEUR	PROYECTOR	UNITÀ DEL PROIETTORE	PROJEKTOR- ENHETEN	
Video frequency	Videofrequenz	Entrée ordinateur	Frecuencia de vídeo	Frequenza video	Videofrekvens	12-150MHz
Horizontal sync.	Horizontalfrequenz	Sync. horizontale	Sinc. horizontal	Sinc. orizz.	Horisontal synk.	15-100KHz
Vertical sync.	Vertikalfrequenz	Sync. verticale	Sinc. vertical	Sinc. vert.	Vertikal synk.	43.5-130 Hz
Computer input	Computereingang	Entrée ordinateur	Entrada de señal del ordenador	Ingresso computer	Datamaskin-inngang	0-1Vpp
Audio input	Audioeingang	Entrée audio	Entrada de audio	Ingresso audio	Lydingngang	1VRMS
Speakers	Lautsprecher	Haut-parleurs	Altavoces	Altoparlanti	Høytalere	2x1 W
Conformance	Prüfzeichen	Conformité	Homologación	Conformità	Oppfyller kravene til	CE, UL, CUL GOST R, FCC Subpart J, Part 15
Power supply	Netzteil	Alimentation électrique	Suministro de corriente	Alimentazione elettrica	Strømforsyning	100-240 VAC, 50-60Hz 2.5-1 A
Computer compatibility resized to native pixel resolution	Computer-kompatibilität. Resizing auf Originalauflösung (Pixel)	Compatibilité ordinateur au redimensionnement de la résolution d'origine (pixels)	Compatibilidad del ordenador ajustada a la resolución pixels. Resolución en pixels	Compatibilità computer (riclassificata in base alla risoluzione pixel originaria)	Datamaskin-kompatibilitet, størrelse endret til naturlig pikseloppløsning	640x480 720x400 800x600 832x624 1024x768 1152x864 1152x870 1280x1024
Video compatibility	Videokompatibilität	Compatibilité vidéo	Compatibilidad de vídeo	Compatibilità video	Video-kompatibilitet	PAL, BGHI, N, combination N, M, NTSC M, N, 4.43, Japan, SECAM

Subject to change Änderungen vorbehalten Sous réserve de modifications Sujetos a posibles cambios Soggetti a modifica Kan endres

PROJECTION DISTANCES	PROJEKTIONS- ABSTÄNDE	DISTANCES DE PROJECTION	DISTANCIAS DE PROYECCIÓN	DISTANZE DI PROIEZIONE	PROJEKSJONS- AVSTANDER	
WIDE Distance Diagonal Width Height	WEITWINKEL Entfernung Diagonale Breite Höhe	GRAND ANGULAIRE Distance Diagonal Largeur Hauteur	GRAN ANGULAR Distance Diagonale Ancho Alto	GRANDANGOLO Distanza Diagonale Larghezza Altezza	VIDVINKEL Avstand Diagonal Bredde Høyde	1.1-10m/3.6-32.5 ft 0.7-6.5m/2.3-21.1 ft 0.6-5.2m/1.9-16.9 ft 0.5-3.9m/1.6-12.7 ft
TELE Distance Diagonal Width Height	TELEOBJEKTIV Entfernung Diagonale Breite Höhe	TELEOBJECTIF Distance Diagonal Largeur Hauteur	TELEOBJETIVO Distance Diagonal Ancho Alto	TELEOBIETTIVO Distanza Diagonale Larghezza Altezza	TELE Avstand Diagonal Bredde Høyde	1.1-10m/3.6-32.5 ft 0.6-5.2m/1.9-16.9 ft 0.5-4.2m/1.6-13.7 ft 0.35-3.2m/1.1-10.4 ft

Variation of +/- 10%. Abweichung von +/- 10% Variation de +/- 10% Variazione di +/- 10% Variación de +/- 10% Variasjon på +/- 10%

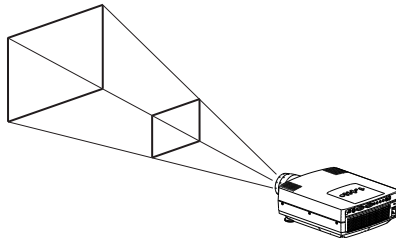









C2 COMPACT / C6 COMPACT

19

www.askproxima.com

TECHNICAL DATA

TECHNISCHE DATEN CARACTERISTIQUES TECHNIQUES DATOS TÉCNICOS DATI TECNICI TEKNISCHE DATA

CONNECTORS	ANSCHLÜSSE	CONNECTEURS	CONECTORES	CONNETTORI	KONTAKTER			
 USB MOUSE 2 DIGITAL USB 1 VCC 2 -Data 3 +Data 4 GND	 MOUSE 1 8 PIN MINIDIN FEMALE 1 Mac ADB 2 PS/2 clock 3 PS/2 data 4 RS232 TXD 5 Not used 6 RS 232 RXD 7 RS 232 CTS 8 GND	 COMPUTER 15 HIGH DENSITY DSUB FEMALE 1 Analog R IN 2 Analog G IN 3 Analog B IN 4 AGND 5 AGND 6 Analog R GND IN 7 Analog G GND IN 8 Analog B GND IN 9 Reserved 10 Sync GND IN 11 AGND 12 DDC/SDA 13 HSync IN 14 VSync IN 15 DDC/SCL	 MONITOR 15 HIGH DENSITY DSUB FEMALE 1 Analog R OUT 2 Analog G OUT 3 Analog B OUT 4 Reserved 5 AGND 6 Analog R GND OUT 7 Analog G GND OUT 8 Analog B GND OUT 9 Reserved 10 Sync GND OUT 11 Not used 12 DDC/SDA 13 HSync OUT 14 VSync OUT 15 DDC/SCL	 COMP IN 3.5 mm JACK TIP: right RING: left STEM: common	 LINE OUT 3.5 mm JACK TIP: right RING: left STEM: common	 VIDEO IN 3.5 mm JACK TIP: right RING: left STEM: common	 VIDEO PHONO/RCA FEMALE STEM: composite SHIELD: GND	 S-VIDEO 4 PIN MINIDIN FEMALE 1 GND 2 GND 3 Luma 4 Common

FCC STATEMENT

ing device, pursuant to Subpart J of Part 15 of FCC rules. Only peripherals (computer input/output devices, terminals, printers, etc.) certified to comply with the Class A limits may be attached to a computer that complies with Class A limits. When connecting to a peripheral device, a shielded input/output cable is required to ensure compliance with FCC rules. The shielded cable that must be used is supplied with the equipment. Operation with non-certified peripherals or non-shielded cables is likely to result in interference to radio and TV reception.

, if not installed and used in accordance with the instruction manual, may cause interference to radio and television reception. It has been tested and found to comply with the limits for a Class A computing device in accordance with the specifications in Subpart J of Part 15 of the FCC rules, which are designed to provide reasonable protection against such interference when operated in a commercial environment. However, there is no guarantee that interference will not occur in a particular installation. If this equipment does cause interference to radio or television reception, which can be determined by turning the equipment off and on, the user is encouraged to try to correct the interference by one or more of the following measures:

- Reorient the receiving antenna.
- Relocate the projector with respect to the receiver.
- Plug the equipment to a different outlet so that equipment and receiver are on different branch circuits.
- Fasten cables using mounting screws to ensure adequate EMI control.

nications Commission (FCC): "How to identify and resolve radio and TV interference problems", available from the U.S. Government Printing Office, Washington, DC 20402, Stock No. 004-000-00345-4.

M SERVICE INFORMATION



**This product contains no user serviceable parts.
Attempts to modify mechanics or electronics inside the housing
will violate any warranties, and may be hazardous.**

If for any reason the product fails to work properly, please contact your dealer for technical support. Prepare a list of the symptoms you observe to diagnosing easier for your dealer.

Please also include the following:

- Serial number of the unit
- Date code
- Software revision (under Main Menu selection ADVANCED/SERVICE/INFO)
- Connected source information (under main menu selection HELP).

For local ASK representation please refer to our web page at:

www.askproxima.com

Free Manuals Download Website

<http://myh66.com>

<http://usermanuals.us>

<http://www.somanuals.com>

<http://www.4manuals.cc>

<http://www.manual-lib.com>

<http://www.404manual.com>

<http://www.luxmanual.com>

<http://aubethermostatmanual.com>

Golf course search by state

<http://golfingnear.com>

Email search by domain

<http://emailbydomain.com>

Auto manuals search

<http://auto.somanuals.com>

TV manuals search

<http://tv.somanuals.com>