

Lucent Technologies
Bell Labs Innovations



User's Manual for Cordless Answering System Telephone 7610

*Fold open this manual for information about this telephone's installation and operation. Please read **Part 1 – Important Product Information**, included in this package*



Part 2

© Copyright 1997 Lucent Technologies, Inc. All rights reserved.
Printed in Mexico. Issue L4
847868304

.....INSTALLATION.....

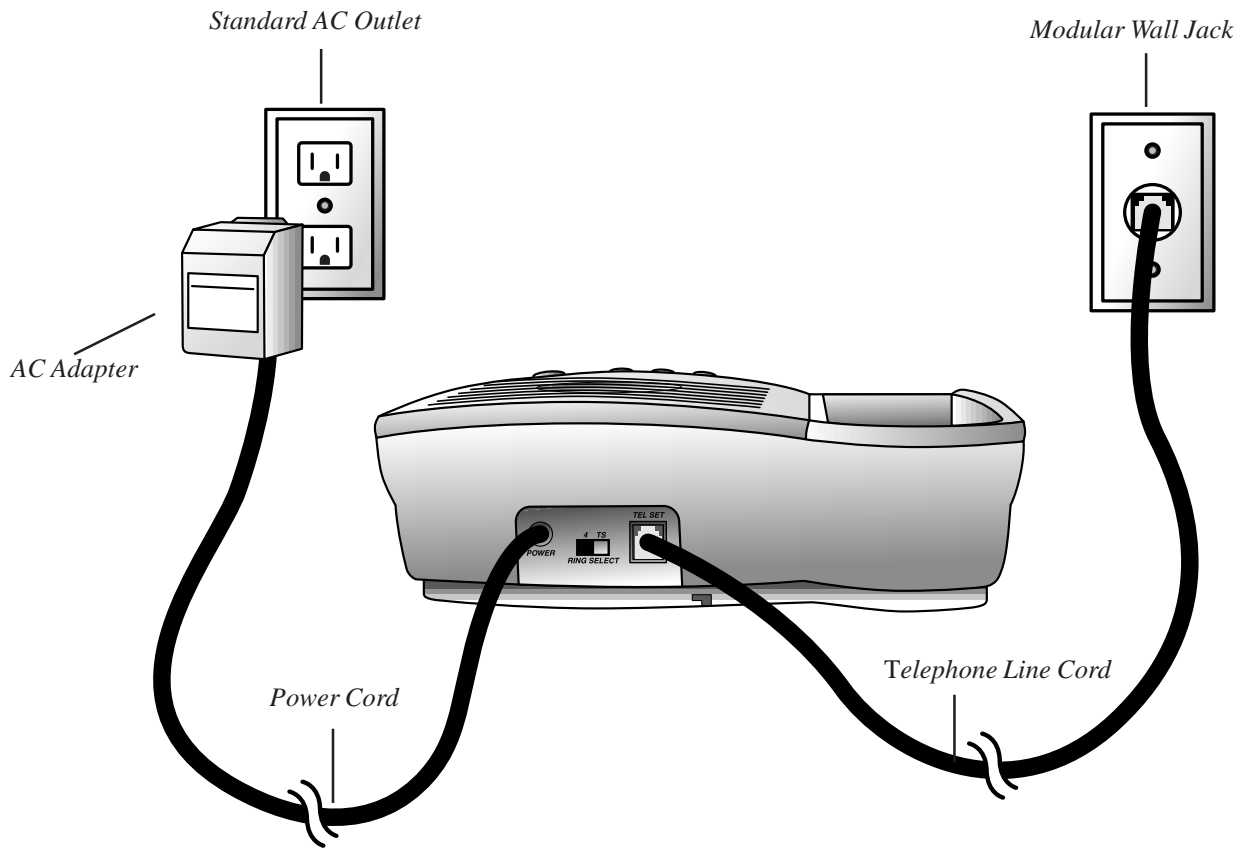

1 Insert the microcassette.

Lift the cover and insert the microcassette with the full reel to the right.

2 Choose a spot near an electrical outlet and a telephone jack.

- This phone requires a modular telephone jack and a standard electrical outlet (120v AC).

3 Install the handset battery.

(For an illustration of battery installation, see "BATTERIES.")

- Plug the battery pack connector into the handset and place the battery pack into the case, so the wires rest above the battery pack.
- Place the battery case cover on the handset by sliding it on its

track up over the battery case until it snaps firmly in place.

- ## 4 Set the Handset Ringer ON/OFF switch.
- Set the switch on the side of the handset to ON so the handset will ring. When this switch is set to OFF the handset will not ring.

*NOTE: If you set the Ringer ON/OFF switch to OFF, the handset battery will last longer. However, when the ringer is set to OFF, you will always need to press **PHONE** to answer a call, even when the handset has been in the base.*

5 Connect the telephone line cord.

Plug one end of the telephone line cord into the jack on the back of the base. (If you are **wall mounting** the phone, wrap the excess cord in the

groove on the bottom of the base.)

Plug the other end of the line cord into a modular phone jack. Make sure the plug snaps firmly in place.

6 Mount the base on the wall (WALL MOUNTING ONLY)

Hold the base so that the mounting knobs on the standard wall jack will fit into the holes on the bottom of the base. Slide the base down onto the knobs until it locks into place.

7 Connect the power cord.

Plug the power cord into the jack labeled **POWER** on the back of the base. Plug the AC adapter on the power cord into an electrical outlet. The microcassette will automatically rewind. When the tape stops moving, the light above the **PLAY/STOP** button.

.....INSTALLATION.....

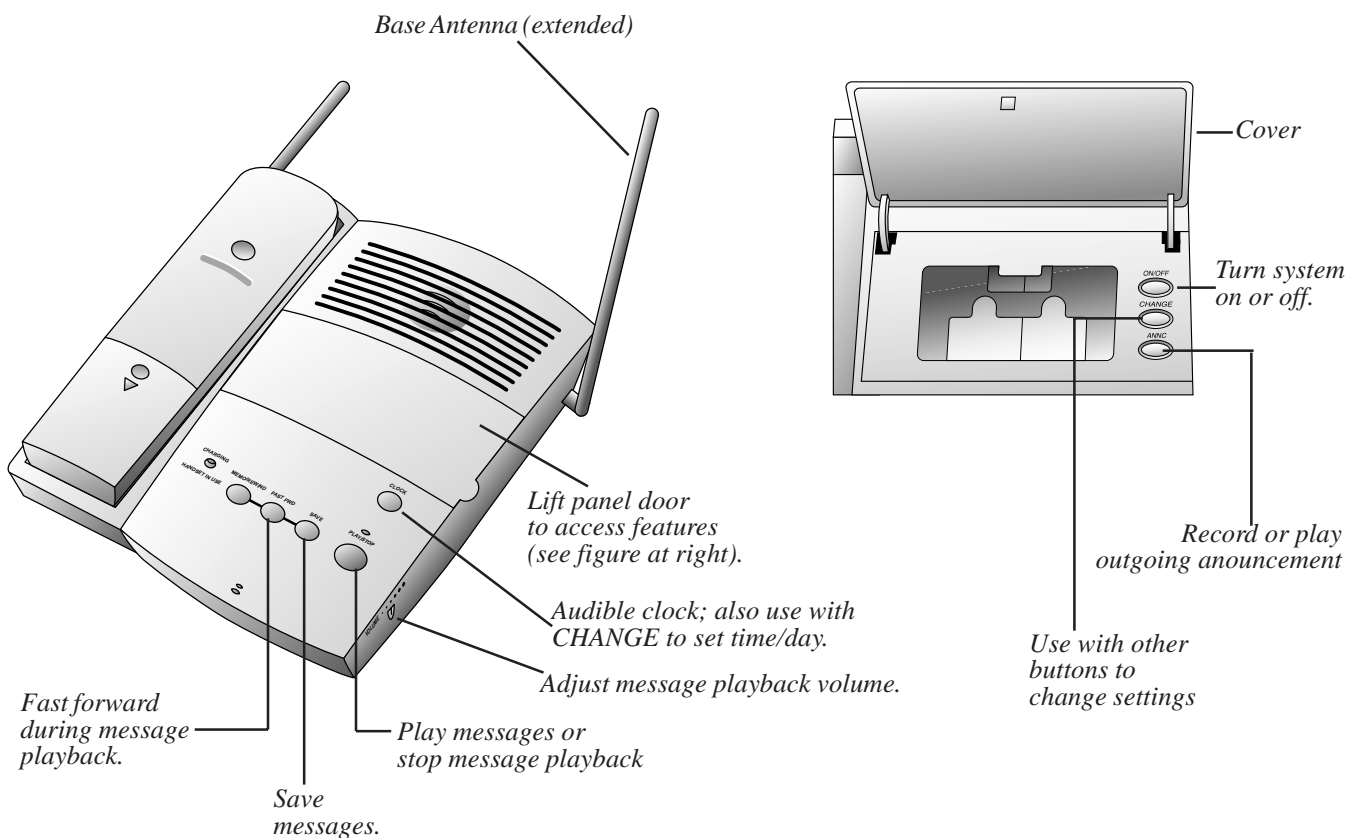

should be on steady. If the light is flashing rapidly, the microcassette is not installed properly. Remove the cassette, and check to see if it's damaged. If it's okay, install it again. After you have installed the cassette, press **PLAY/STOP** to reset the system.



CAUTION: Use only the power supply provided with this product. To obtain a replacement, call Lucent Technologies at 1 800 222-3111. Lucent Technologies Power Supply DAS-2. Input: 120V, 60Hz, 15W. Output: 9V AC, 780 mA.

8 Charge the handset batteries before use.

Place the handset face down in the base. The CHARGING light on the

base goes on to show the handset is in the right position to charge the batteries. The batteries will be fully charged in 14 hours.

9 Check for dial tone.

Make sure the base antenna is upright. After the batteries are charged, pick up the handset and check for dial tone by pressing **PHONE**; the PHONE light should go on and you should hear a dial tone. Press **PHONE** to hang up.

10 Set the dial mode.

If you have touch tone service, the phone will be ready to use as soon as the battery is charged.

If you have dial pulse service, you'll need to set the dial mode. Press

PHONE (wait for dial tone), **PROG/MEM**, **#**, **#**, **#**, **3**. To return to touch tone dialing with touch tone service, when the phone is off, press **PHONE** (wait for dial tone), **PROG/MEM**, **#**, **#**, **#**, **8**.

IMPORTANT: After you have installed the 7610, you will need to record an announcement that callers will hear when the system answers. Please see the Answering System Operation section of this manual.

.....B A T T E R I E S.....

Charging the Handset Battery Pack

The batteries need charging when:

- The phone beeps four times when you press **[PHONE]**.
- The **LOW BATTERY** light on the handset flashes on and off.
- The phone does not respond when you press **[PHONE]**, and no lights go on.

Place the handset in the base so the **CHARGING** light goes on. The batteries will be fully charged in 14 hours.

NOTE: The handset must lie flat in the base, with the keypad facing down, when charging. The charging light in the base goes on if the handset is positioned correctly.

A fully charged battery maintains standby power for up to 14 days when the Handset Ringer ON/OFF switch is set to **ON**, and up to 21 days when the Handset Ringer ON/OFF switch is set to **OFF**.

If it's more convenient for you, you can leave the handset in the base all the time. It is impossible to overcharge the batteries.

If you get a low battery indicator even after the batteries have been charged 14 hours, the battery should be replaced.



CAUTION: To reduce the risk of fire or injury to persons or damage to the telephone, read and follow these instructions carefully.

- Use Lucent Technologies Replace ment Battery 4051 in the handset.
- Do not dispose of the battery in a fire. The cell might explode.
- Do not open, puncture or mutilate the battery. Released electrolyte is corrosive and might cause damage to the eyes or skin. It might be toxic if swallowed.

Replacing the Handset Battery Pack

- 1 Remove the battery case cover** on the handset by pressing on the indentation and sliding the cover downward.
- 2 Lift out the old battery pack** and unplug it from the handset.
- 3 Hold the new battery pack and plug the connector into the handset.** Place the battery pack into the case, so the wires rest above the battery pack.
- 4 Replace the cover** by sliding it on its track up over the battery case until it snaps firmly into place.
- 5 The new batteries must be charged before using the phone.** Place the handset face down in the base and allow it to charge for 14 hours. The telephone might operate before that, but for best performance, let the handset batteries charge fully.

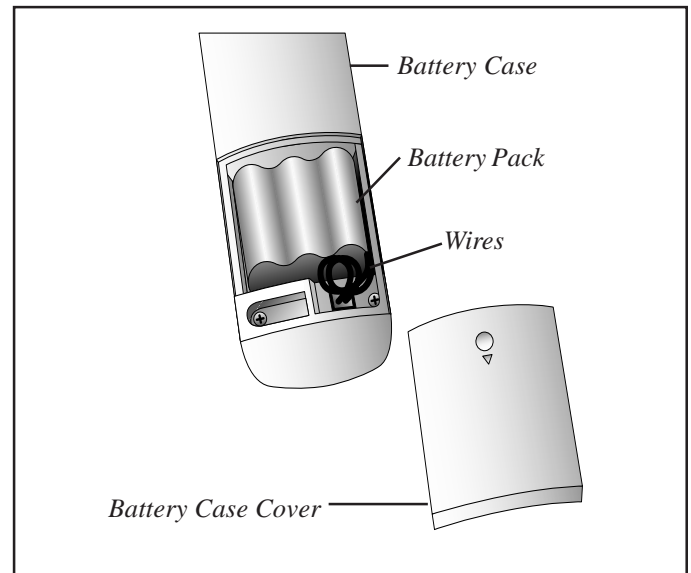
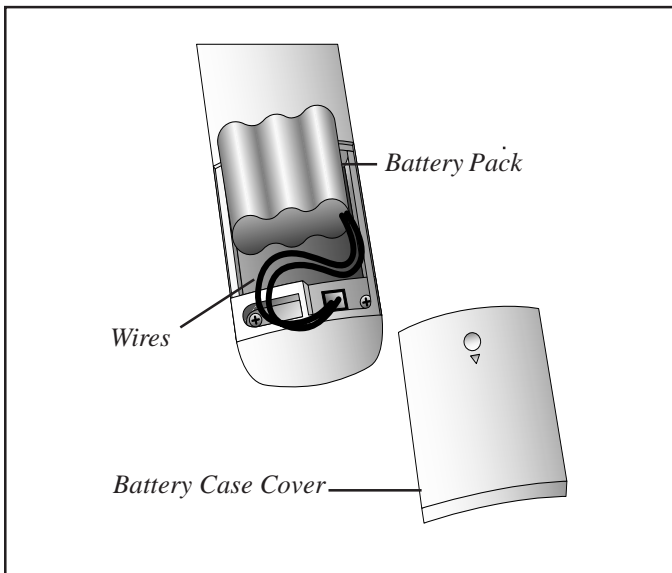

.....IN CASE OF DIFFICULTY.....

If you have difficulty operating this phone, try the suggestions below. If you still have trouble, call Lucent Technologies at 1 800 222-3111.

If the phone does not work at all, check these items first

- Make sure the power cord is plugged into the base and an electrical outlet not controlled by a wall switch.
- Make sure the telephone line cord is plugged firmly into the base unit and the telephone jack.
- If the phone does not beep, or beeps four times when you press **PHONE**, the batteries might need recharging.
- If the handset LOW BATTERY light is flashing, the batteries need recharging.
- Make sure the battery pack is installed correctly.
- If the battery pack will not charge, try cleaning the charge contacts with an eraser. If the battery pack will still not charge, replace it with Lucent Technologies Replacement Battery 4051.
- If the above suggestions do not solve the problem, try resetting the security code (see next section).

If you hear a two-beep signal when you try to use the handset

- The handset and base are not communicating properly. You might be out of range while attempting to dial. Move closer to the base and try the call again.
- **If moving closer to the base does not help**, the handset and base might be set to different security codes. To reset the security code, try the following:
 - Place the handset in the base, and check to make sure the CHARGING light is on. Wait 15 seconds, then pick up the handset and press **PHONE**. The phone should operate properly. If it does not, try the next step.

- Place the handset in the base, and check to make sure the CHARGING light is on. Unplug the AC adapter from the outlet, wait 15 seconds, then plug it in again. The CHARGING light should go on. Wait another 15 seconds, then pick up the handset and press **PHONE**. The phone should operate properly. If it does not, try the next step.
- Pick up the handset, open the battery compartment, and unplug the battery pack. Wait 15 seconds, then reinstall the battery pack, close the battery compartment, place the handset in the base, and check to make sure the CHARGING light is on. Wait another 15 seconds, then pick up the handset and press **PHONE**. The phone should operate properly.

If you have no dial tone, check all the previous suggestions. If you still do not hear a dial tone, disconnect the phone and try another phone in the same jack. If there is no dial tone on that phone either, the problem is probably in your wiring or local service. Call your local telephone service company.

If you hear noise or interference when using the phone

- You may be out of range. Move closer to the base.
- Press and release **CHANNEL** to change to another of the 25 channels available. If the noise is exceptionally loud, move closer to the base before changing channels.
- Household appliances plugged into the same circuit as the base can sometimes cause interference. Try moving the appliance or the base to another outlet.
- The layout of your home or office might be limiting the operating range. Try moving the base to another location, preferably on an upper floor.

- Make sure the base antenna is upright.
- Disconnect the base from the telephone jack and plug in a corded telephone. If you still hear noise or interference, the problem is probably in your wiring or local service. Call your local telephone service company.

If the phone does not ring when you receive a call

- Make sure the Handset Ringer ON/OFF switch is set to **ON**.
- Make sure the telephone line cord is connected firmly to the base and the telephone jack.
- Make sure the power cord is plugged into an outlet not controlled by a wall switch.
- You might be too far from the base. Move closer to the base.
- You might have too many extension phones on your telephone line to allow all of them to ring. Try unplugging some of the other phones.
- Press **CHANNEL** to change to another channel.

If your telephone misdials or you don't hear the other person right away

- It might take a few seconds for your handset to find a good connection to the phone system. While it is searching, the PHONE light blinks rapidly. Do not start dialing until the PHONE light is on steadily.
- If you have dial pulse (rotary) service, you'll need to set the dial mode to dial pulse. Press **PHONE**, **PROG/MEM**, **#**, **#**, **#**, **3**.
- If you have TONE service and you hear strange clicks while you are dialing, you'll need to set the dial mode to touch tone. Press **PHONE**, **PROG/MEM**, **#**, **#**, **#**, **8**.

If the Message Light flashes rapidly

- If the system does not play messages when you press **PLAY/STOP**, check the cassette to see if it is broken or jammed. If so, replace the cassette, then press **PLAY/STOP** to reset the system.

.....IN CASE OF DIFFICULTY.....

If you have difficulty hearing messages

- If messages are garbled, the recording heads may be soiled and should be cleaned.
 - Unplug the system from the electrical outlet.
 - Remove the cassette tape.
 - Use any good tape deck cleaning kit, and follow the manufacturer's instructions
- **OR** —
- Rub the front face of the recording heads lightly with a soft, clean cotton swab moistened slightly with isopropyl alcohol.
- Use any cleaning fluid sparingly. If you spill fluid into the interior, unplug power and line cords and let the system dry thoroughly before using.

- Try sliding the Volume control on the side of the base upward to increase volume.

If the recording tape sticks or malfunctions

- Use only high-quality MC-30 or MC-60 microcassette tapes.
- If the tape has been used for an extended period, it may be worn and should be replaced.

If the system does not answer after the correct number of rings

- If the Ring Select switch is set to **TS**, the system answers after 4 rings when you have no new messages, and after 2 rings when you have new messages.
- The system might be off, or the tape might be full. In either of these cases, the system answers after 10 rings.
- The tape might be missing, broken, or incorrectly installed.

If the system does not respond to remote commands

- Make sure you are calling from a touch tone telephone. If you hear clicks when you dial, the phone is not a touch tone phone.
- There might be noise or interference on the phone line you are using. Press dial buttons firmly.
- Make sure you are entering your Remote Access Code correctly.
- A power failure might have caused the Remote Access Code to revert to its original setting.

.....O P E R A T I O N

Making A Call

- 1 Press **[PHONE]**, and wait for the PHONE light to go on steadily.
- 2 When you hear a dial tone, dial the number.

NOTE: You might experience a slight delay before you hear a dial tone, as the AutoSelect® feature searches for a clear channel.

Answering a Call

If this phone is ringing and the handset is in the base, lift the handset. The PHONE light goes on, and the call is connected.

*NOTE: If the ringer switch is set to OFF, press **[PHONE]** to answer the call.*

- If the handset is out of the base, press **[PHONE]**. The PHONE light goes on, and the call is connected.
- Although ringing stops when you answer, you might not be able to hear the other party until the PHONE light goes on steadily.

Ending a Call

To end a call, place the handset into the base or press **[PHONE]**.

Redial

The last number dialed (up to 16 digits) on this phone is stored in redial memory until you dial another number.

- 1 Press **[PHONE]**, and wait for the PHONE light to go on.
- 2 When you hear a dial tone, press **[REDIAL]**.

Battery Saver Control Feature/Ringer ON-OFF

Set the switch on the side of the handset to **OFF** to prevent the handset from ringing.

When the ringer switch is set to **OFF**, the handset stays ready to use for up to 21 days in standby mode before you have to return it

to the base for recharging. You can still use the handset to make a call or to answer a call if you hear an extension phone ringing.

When the ringer ON/OFF switch is set to **ON**, the handset stays ready to use for up to 14 days in standby mode.

Handset Volume

The handset volume can be set to three different levels. Each time you press **[VOL]** the level changes.

Temporary Tone

NOTE: If you have touch tone service, you do not need to use the Temporary Tone feature.

If you have dial pulse (rotary) service, this feature allows you to enter codes or tones needed to operate answering machines, or to use electronic banking services, calling cards, and other special services. This feature will operate most special services; however, some services may actually require a touch tone line. To be sure, ask the company that provides the special service.

- 1 Dial the call, then press **[*]** (tone). Any dial buttons pressed after this send tone signals.
- 2 After you hang up, the phone automatically returns to dial pulse (rotary) dialing

Mute

Mute allows you to hear your caller, but prevents the caller from hearing you.

While on a call:

- Press **[MUTE]**. The MUTE light goes on.

To deactivate the Mute feature :

- Press **[MUTE]** again. The MUTE light goes off.

Flash

Press **[FLASH]** to activate custom-calling services such as Call Waiting or 3-Way Calling. You may have to press other buttons before or after **[FLASH]** as explained in custom-calling instructions provided by your local telephone service company.

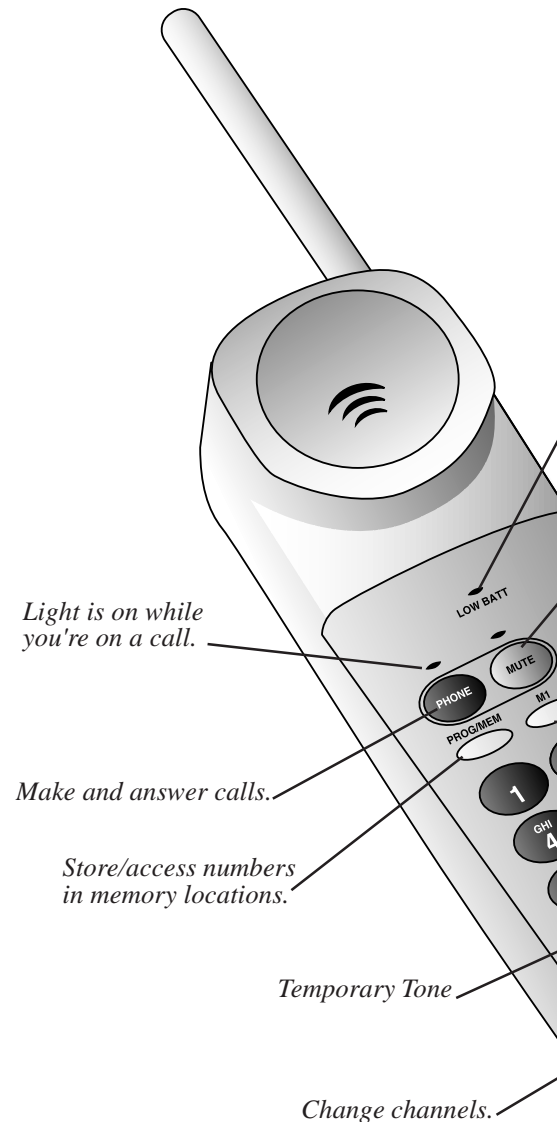

..... M E M O R Y

This cordless phone can store 10 telephone numbers that you can dial just by pressing **PROG/MEM** and one of the number buttons. Additionally, the 7610 offers a memory location accessed by pressing **M1**.

Storing Speed-Dial Numbers

- 1 Make sure the PHONE light is off.
- 2 Press **PROG/MEM**.
- 3 Enter the phone number (up to 16 digits).
- 4 Press **PROG/MEM**.
- 5 Press any number button from 0 to 9 for the memory location where the number is to be stored.
- 6 A three-part tone confirms that the number was stored properly. If you hear a long buzzing tone, or nothing at all, press **PHONE**, then follow the steps above to store the number again.

For example, to store 555-1234 in memory location 9:

Press **PROG/MEM**, **5**, **5**, **5**, **1**, **2**, **3**, **4**, **PROG/MEM**, **9**.

Storing a Number in M1

- 1 Make sure the PHONE light is OFF.
- 2 Press **PROG/MEM**.
- 3 Enter the phone number (up to 16 digits).
- 4 Press **PROG/MEM**.
- 5 **M1**.

NOTE: You may choose to store emergency numbers in the memory locations. The manufacturer assumes no responsibility for customer reliance upon this memory feature.

Storing a Pause In a Memory Dial Number

When storing a number in memory, press and hold down the number button that comes before the pause, until you hear the second beep. This inserts a 1.5 second pause after that digit. If you hold the number button down longer, you will hear more beeps as additional pauses are stored.

NOTE: Each pause you store is counted as a digit. You can store up to 16 digits in each memory location.

For example, to store 9, PAUSE, 555-1234 in memory location 3:

Press **PROG/MEM**, **9**, (hold the **9** for 2 seconds, until a second beep is heard.) Then press **5** **5** **5** **1** **2** **3** **4** **PROG/MEM** **3**.

Dialing Speed-Dial Numbers

- 1 Press **PHONE**.
- 2 Press **PROG/MEM**.
- 3 Press the number button (0-9) you assigned to the number you're calling. **For example, to dial the number stored in location 9, press** **PHONE**, **PROG/MEM**, **9**.

Dialing M1

- 1 Press **PHONE**.
- 2 Press **M1**.

Storing Numbers Just Dialed

Whenever you make a telephone call, you can store in memory the number you dialed. Press **REDIAL** instead of entering the telephone number when storing speed-dial numbers.

Replacing a Stored Number

You can replace a stored number by storing a new number in its place.

Memory Guard

The phone numbers you store in memory are protected from loss when you change the handset battery, or in the event of a power failure.

Directory Label

There is a directory label that you can use to keep a record of names or telephone numbers of the numbers stored in memory locations. You can place this label on the handset or the base.

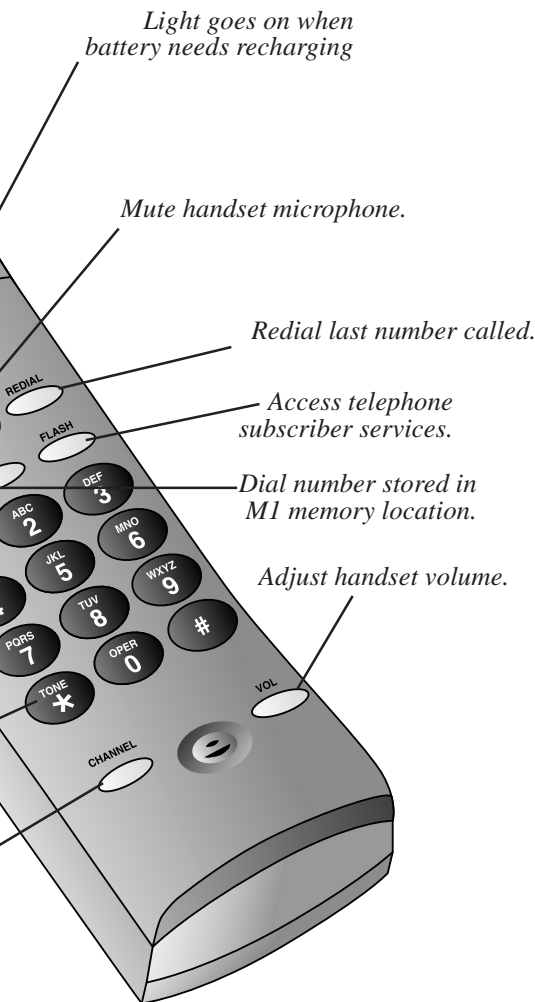

.....O P E R A T I N G R A N G E.....

This cordless telephone operates at the maximum power allowed by the Federal Communications Commission (FCC). Even so, the handset and base can communicate over only a certain distance — which can vary with the locations of the base and handset, the weather, and the construction of your home or office.

When you make a call, if the handset is at to a point where the base and handset can not communicate, the handset will sound two short beeps, indicating that you are out of range. Move closer to the base to restore normal operation.

If you receive a call while you are out of range, the handset might not ring — or if it does ring, the call might not connect when you press **PHONE**. Move closer to the base, then press **PHONE** to answer the call.

If you move out of range during a phone conversation, you will hear noise or interference. To improve reception, move closer to the base.

If you move out of range while on a call, the phone will be left “off the hook.” To hang up properly, walk back into range, periodically pressing **PHONE** until the **PHONE** light goes off.

Changing Channels

This cordless telephone has an advanced 25-channel **AutoSelect**® feature that minimizes the chance of interference. Every time you answer or make a call, the AutoSelect feature searches for and selects a clear channel.

In the unlikely event that you notice noise or interference while using the handset:

- 1 Press **CHANNEL**.
- 2 If the interference does not clear, continue to press **CHANNEL** until you find a clear channel (your call will not be interrupted)
— **OR** —
Move closer to the base and press **CHANNEL**.

NOTE: You must be in range to change channels.

.....ANSWERING SYSTEM OPERATION.....

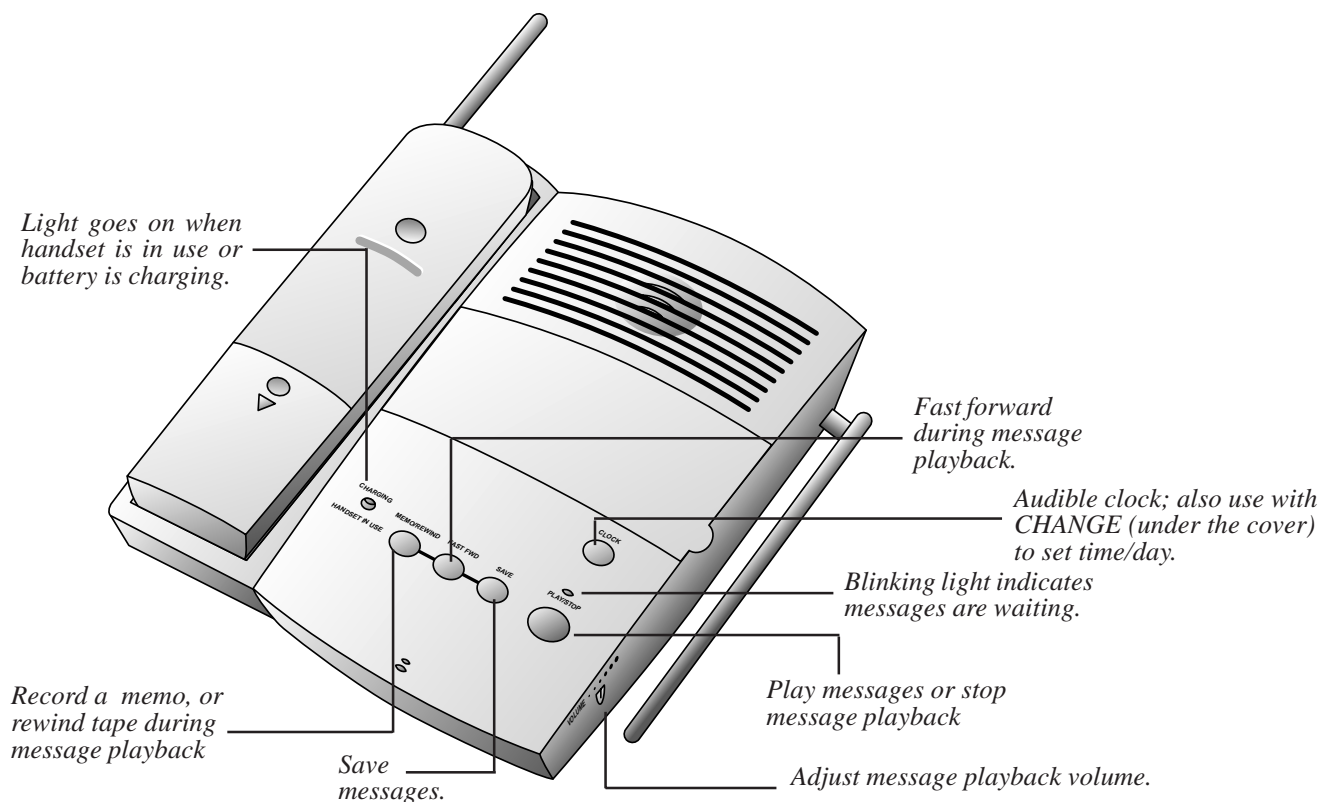

Volume Control

Use the volume control on the side of the base to adjust the answering system volume. Slide the control up toward the back of the base to increase volume while listening to your announcement or messages, or down toward the bottom of the base to decrease volume.

Recording Your Announcement

Before using this answering system, you need to record the announcement (up to 30 seconds long) that callers will hear when the system answers a call. Your announcement should tell callers that they will hear a series of beeps, or one long beep, before the system begins recording the message.

1 Prepare an announcement.

For example: *Hello. I can't come to the phone right now. Please leave your name, telephone number, and short message after you hear a series of beeps or one long beep. I will return your call as soon as I can.*

- 2 Press and release **CHANGE**, located under the microcassette cover.
- 3 Press and release **ANNC** and wait for the beep.
- 4 After the beep, speak toward the front of the unit, from about 9 inches away.
- 5 Press and release **PLAY/STOP** when you are finished. The tape resets automatically and plays the announcement.

To review your announcement — Press and release **ANNC**, located under the microcassette cover.

Turning the System On and Off

Press and release **ON/OFF** located under the microcassette cover. The **PLAY/STOP** light is lit steadily or blinking slowly when the system is on, and is unlit when the system is off.

NOTE: If the **PLAY/STOP** light flashes rapidly, the tape might be missing or broken. Check the tape, then press **PLAY/STOP** to reset the system.

Setting the Clock

You'll need to set the clock so that it can record the day and time that each message is received.

- 1 Press and release **CHANGE**.
- 2 Press and release **CLOCK**. You will hear a day of the week.
- 3 To change the day, hold down **FAST FWD** or **MEMO/REWIND** until you hear the correct day, then release the button.
- 4 Press and release **CLOCK**. You will hear an hour setting.
- 5 To change the hour, hold down **FAST FWD** or **MEMO/REWIND** until you hear the correct hour, then release the button.
- 6 Press and release **CLOCK**. You will hear a minutes setting.
- 7 To change the minutes setting, hold down **FAST FWD** or **MEMO/REWIND** until you hear the correct minutes setting, then release the button.
- 8 Press and release **CLOCK**. You will hear the day and time setting. If it is incorrect, start over at Step 1.

To review the day and time — Press and release **CLOCK**.

.....ANSWERING SYSTEM OPERATION.....

Ring Select

Use the Ring Select switch on the back side of the base unit to select how many times the line will ring before the system answers a call. Set to **4** for four rings, or set to **TS** for Toll Saver. When you set the system to **TS**, the system answers after 4 rings when you have no new messages, and after 2 rings when you have new messages.

Answering Calls

When the system answers a call, the caller hears the announcement you recorded, followed by a single beep or a series of beeps. After the final beep, the system begins recording your caller's message. The system hangs up when the caller hangs up or is silent for 7 seconds or after the maximum message time of 4 minutes.

NOTE: If there are any messages recorded on the tape, the caller hears a series of beeps while the system goes to the end of the last recorded message. To reduce the number of beeps and the time it takes before a caller can leave a message, listen to your messages frequently, and do not save a large number of messages.

Bypassing the Announcement

You might wish to let certain callers know that they can leave a message without listening to your announcement. Callers can press **#** during the announcement and then leave a message after the series of beeps.

Message Light

The light above **(PLAY/STOP)** indicates how many messages you've received. The light blinks once for each message, pauses, and blinks again. For example, if you have 5 messages, the light blinks 5 times, pauses, then repeats.

Listening to Your Messages

Before listening to your messages, set the message volume control so you can hear the messages. When you press **(PLAY/STOP)** the system announces the number of messages received. After each message, the system announces the day and time the message was received. After playing the last message, the system announces "End of messages."

Play messages — Press and release **(PLAY/STOP)**.

Clear messages — After you've played your messages, the system automatically resets to record new messages over the old ones. The old messages are not cleared until new ones are recorded.

Save message — Press and release **(SAVE)** to save messages. The light blinks to show that messages have been saved.

Rewind — Hold down **(MEMO/REWIND)** while the system is playing messages. The tape rewinds as long as you hold down the button.

Fast forward — Hold down **(FAST FWD)** while the system is playing messages. The tape fast forwards as long as you hold down the button.

Interrupt message playback — Press and release **(PLAY/STOP)**. To continue playback, press and release **(PLAY/STOP)**. (If you do not return to playing messages within 60 seconds, the system automatically saves all messages and resets to answer calls.)

Replay messages — Wait for the tape to reset, then press and release **(PLAY/STOP)**.

Recording a Memo

You can record a memo to be stored as an incoming message. The memo will be

played back with other messages.

- 1 Hold down **(MEMO/REWIND)**. After the beep, speak toward the front of the base.
- 2 To stop recording, release **(MEMO/REWIND)**.

Call Screening/Intercept

Set the system to answer calls, and set the volume control so you can hear the caller's message.

If you decide to take the call, you can do so from the cordless handset or from any telephone on the same line. The system stops recording and resets to answer calls. If the answering system doesn't disconnect immediately, press the **(FLASH)** button on the cordless handset or flash the switchhook on another telephone.

When the Tape is Full

When the tape is completely full, the system cannot record a caller's message. The system answers calls after 10 rings and beeps twice, but it does not play an outgoing announcement or record the caller's message.

When the tape is full, you can play all of the messages either locally or remotely and then clear messages — **OR** — you can turn the tape over to record on the other side — **OR** — you can change the microcassette.

NOTE: If you turn the tape over or change the tape, be sure to follow all the directions in the next section.

Changing the Microcassette

- 1 Press and release **(ON/OFF)** to turn the system off.
- 2 Remove the old cassette.
- 3 Turn the cassette over, or install a new cassette.
- 4 Press and release **(ON/OFF)** to turn the system on.
- 5 After the tape resets, record a new announcement if necessary.

.....ANSWERING SYSTEM OPERATION.....

FROM A REMOTE TOUCH TONE PHONE

Remote Access Code

The Remote Access Code is a 3-digit code which lets you access your 7610 answering system away from your home or office. The factory setting is 123 (printed under the microcassette lid on the base). You can change this code to any 3-digit number between 100 and 999, except 323 and 523. You can only change the Remote Access Code remotely; you cannot change it at the base.

Changing Your Remote Access Code

- 1 Press **9**, **9** after the two beeps. The system beeps once.
- 2 Enter your new 3-digit Remote Access Code. The system beeps twice.

NOTE: A power failure may cause the Remote Access Code to return to its original setting.

Listening to Your Messages

- 1 Dial your telephone number from a touch tone phone.
- 2 When the system answers, enter your Remote Access Code. The system announces the number of messages received, then beeps twice. (If there are no messages, the system announces "No messages.")

- 3 After the two beeps, wait 4 seconds, and the system plays back messages
— **OR** —
Press and release **7** to play all of your messages (if there are no messages, the system announces "End of messages")
— **OR** —
Press and release **2** to play only new messages (if there are no new messages, the system announces "No new messages.")
- 4 **To replay** — Press and release **7** after all messages have been played.

To rewind — Hold down **4** to rewind. When you release **4**, the tape resumes playing from its new position.

To skip messages — Hold down **6** to fast forward. When you release **6** the tape resumes playing from its new position.

To clear messages — Press **3**, **3** after you hear the two-beep signal. The tape rewinds and resets to record new messages over the old ones.

To stop playback — Press and release **5**. To resume playback, press and release **7**.

Recording a New Announcement

- 1 Press **7**, **X** after the two beeps. You will hear a series of short beeps, then one long beep.
- 2 After the long beep, record your new announcement..
- 3 When you finish, press and release **5**. The system plays your new announcement.
- 4 To review your new announcement, press **7**, **7** after the two-beep signal.

Turning System On

When the system is off, it answers after 10 rings and beeps twice.

- 1 Press and release **0** to turn the system on.
- 2 The system beeps twice to indicate the system is on. To leave a message, press and release **#**. If you're not leaving a message, hang up.

Turning System Off

Press **8**, **8** after the two beeps.

When the Tape is Full

When the tape is full, the system answers after 10 rings and beeps twice.

- 1 Enter your Remote Access Code within 15 seconds after the beeps to listen to messages.
- 2 Press **3**, **3** after you listen to messages to clear them and make room for new messages.



Lucent Technologies
Bell Labs Innovations



Answering System 7610

Operation From a Remote Touch Tone Phone

To access your answering system:

- 1 Dial your telephone number.
- 2 When the system answers, enter your 3-digit Remote Access Code. The system announces the number of messages received, then beeps twice and is ready to accept a command. See the other side of this card for a complete list of remote commands.

© 1997 Lucent Technologies, Inc. All rights reserved. Printed in Mexico. Issue 1. 847875440



Lucent Technologies
Bell Labs Innovations



Answering System 7610

Operation From a Remote Touch Tone Phone

To access your answering system:

- 1 Dial your telephone number.
- 2 When the system answers, enter your 3-digit Remote Access Code. The system announces the number of messages received, then beeps twice and is ready to accept a command. See the other side of this card for a complete list of remote commands.

© 1997 Lucent Technologies, Inc. All rights reserved. Printed in Mexico. Issue 1. 847875440



**COMMAND****PRESS**

Play all messages	[1]
Play only new messages	[2]
Replay messages	[1] after playing messages
Rewind	Hold down [4]; release to play.
Fast Forward	Hold down [6]; release to play.
Clear messages	[3], [3].
Stop	[5]; press [1] to play..
Record announcement	[7], [*], speak after long beep, press [5] to stop.
Change Remote Access Code	[9], [9], enter new code.
Turn system on	[0]
Turn system off	[8], [8]

**COMMAND****PRESS**

Play all messages	[1]
Play only new messages	[2]
Replay messages	[1] after playing messages
Rewind	Hold down [4]; release to play.
Fast Forward	Hold down [6]; release to play.
Clear messages	[3], [3].
Stop	[5]; press [1] to play..
Record announcement	[7], [*], speak after long beep, press [5] to stop.
Change Remote Access Code	[9], [9], enter new code.
Turn system on	[0]
Turn system off	[8], [8]



7610

Lucent Technologies 

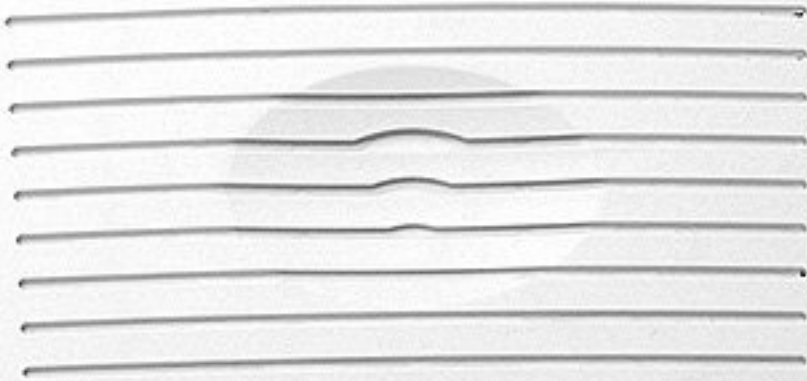

Cordless Answering System
7610 Telephone



Lucent Technologies
Previously Part of AT&T

Clarity Plus® Sound

25-Channel *AutoSelect*® Feature

Time/Day Stamp

21 Day Standby Battery Life

AT&T

IMPORTANT
The handset battery
MUST be installed and
charged prior to use.

CHARGING

HANDSET IN USE

MEMO/REWIND

FAST FWD

SAVE

PLAY/STOP

CLOCK

7610

Lucent Technologies 

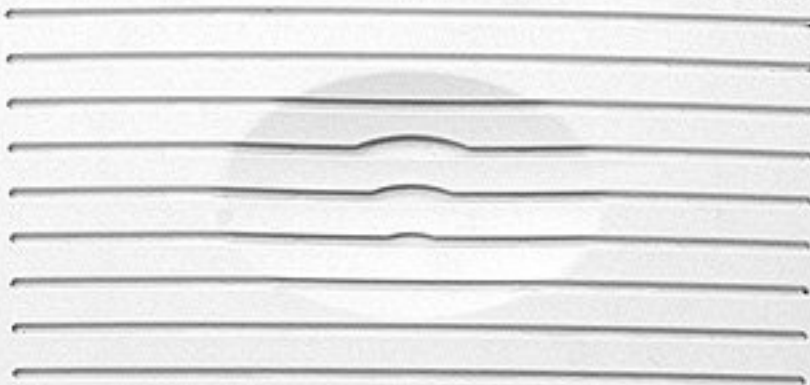

Cordless Answering System
7610 Telephone



Lucent Technologies
Previously Part of AT&T

Clarity Plus™ Sound

25-Channel *AutoSelect*™ Feature

Time/Day Stamp

21 Day Standby Battery Life

44790208

CLOCK



CHARGING



HANDSET IN USE

MEMO REWIND



FAST FWD



SAVE



PLAY/STOP



7610

Lucent Technologies 



ON/OFF

CHANGE

INVC

CLOCK

CHARGING

MEMO/REWIND

FAST FWD

SAVE

PLAY/STOP

HANDSET IN USE

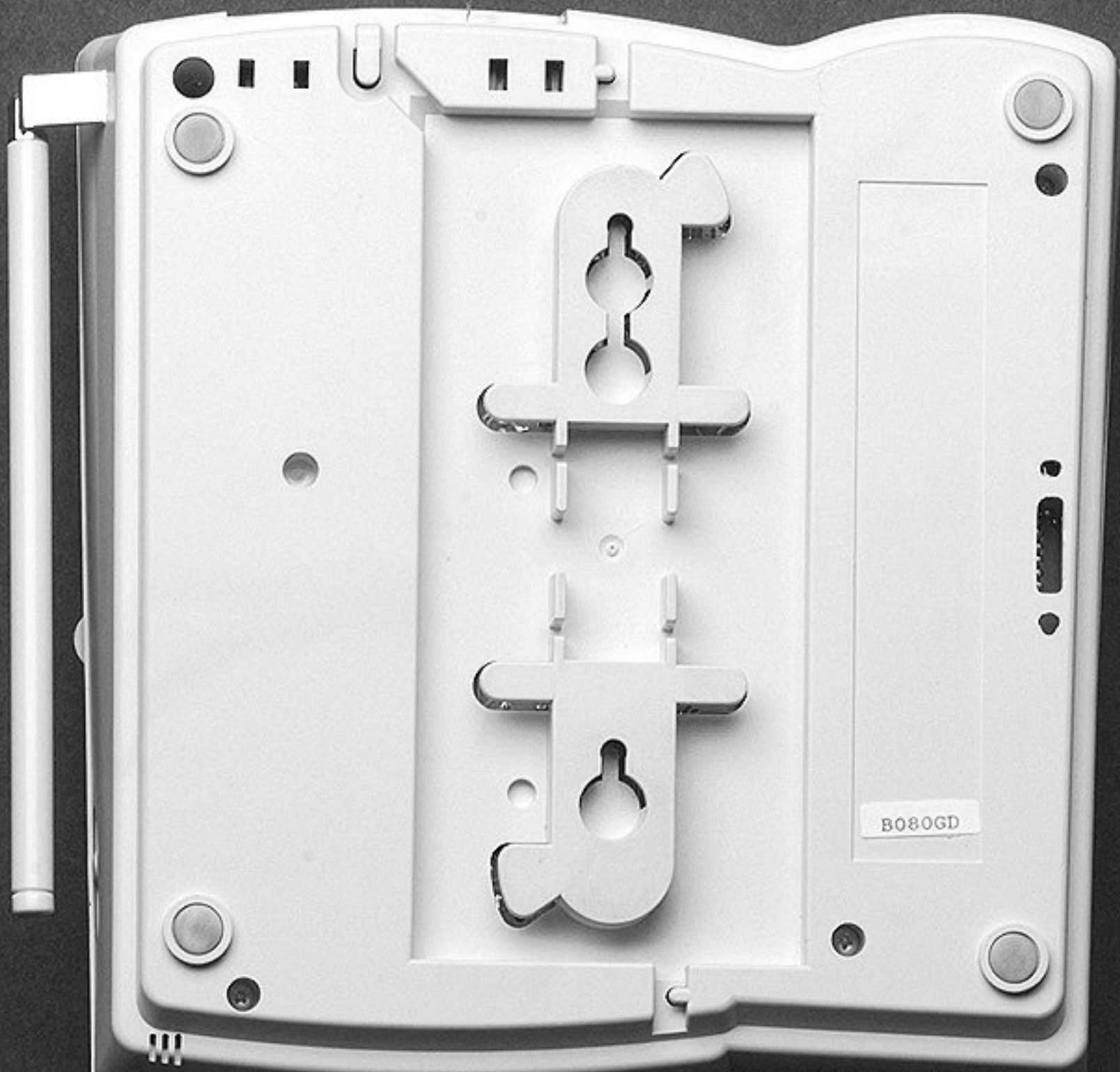

B080GD







LOW BATT

PHONE

MUTE

REDIAL

PROG/MEM

MT

FLASH

1

ABC
2

DEF
3

GHI
4

JKL
5

MNO
6

PQRS
7

TUV
8

WXYZ
9

TONE
*

OPER
0

#

CHANNEL

VOLUME

Lucent Technologies
7610



RINGER
BATT SAVE/OFF ON



IMPORTANT
The handset battery
MUST be installed and
charged prior to use.

Free Manuals Download Website

<http://myh66.com>

<http://usermanuals.us>

<http://www.somanuals.com>

<http://www.4manuals.cc>

<http://www.manual-lib.com>

<http://www.404manual.com>

<http://www.luxmanual.com>

<http://aubethermostatmanual.com>

Golf course search by state

<http://golfingnear.com>

Email search by domain

<http://emailbydomain.com>

Auto manuals search

<http://auto.somanuals.com>

TV manuals search

<http://tv.somanuals.com>