

# **ASUS<sup>®</sup> CUW(E)-FX**

## Intel<sup>®</sup> 810 FlexATX Motherboard

# USER'S MANUAL

### *Special Features*

#### **CUWE-FX**

- Intel 810E Chipset with support for 133/100/66MHz FSB
- 4MB 32-bit 133MHz SDRAM display cache onboard

#### **CUW-FX**

- Intel 810 Chipset with support for 100/66MHz FSB
- Optional 4MB 32-bit 100MHz SDRAM display cache onboard

## USER'S NOTICE

---

No part of this manual, including the products and software described in it, may be reproduced, transmitted, transcribed, stored in a retrieval system, or translated into any language in any form or by any means, except documentation kept by the purchaser for backup purposes, without the express written permission of ASUSTeK COMPUTER INC. ("ASUS").

ASUS PROVIDES THIS MANUAL "AS IS" WITHOUT WARRANTY OF ANY KIND, EITHER EXPRESS OR IMPLIED, INCLUDING BUT NOT LIMITED TO THE IMPLIED WARRANTIES OR CONDITIONS OF MERCHANTABILITY OR FITNESS FOR A PARTICULAR PURPOSE. IN NO EVENT SHALL ASUS, ITS DIRECTORS, OFFICERS, EMPLOYEES OR AGENTS BE LIABLE FOR ANY INDIRECT, SPECIAL, INCIDENTAL, OR CONSEQUENTIAL DAMAGES (INCLUDING DAMAGES FOR LOSS OF PROFITS, LOSS OF BUSINESS, LOSS OF USE OR DATA, INTERRUPTION OF BUSINESS AND THE LIKE), EVEN IF ASUS HAS BEEN ADVISED OF THE POSSIBILITY OF SUCH DAMAGES ARISING FROM ANY DEFECT OR ERROR IN THIS MANUAL OR PRODUCT.

Product warranty or service will not be extended if: (1) the product is repaired, modified or altered, unless such repair, modification or alteration is authorized in writing by ASUS; or (2) the serial number of the product is defaced or missing.

Products and corporate names appearing in this manual may or may not be registered trademarks or copyrights of their respective companies, and are used only for identification or explanation and to the owners' benefit, without intent to infringe.

- QuickStart and JumperFree are trademarks of ASUSTeK Computer Inc.
- Intel, LANDesk, and Pentium are registered trademarks of Intel Corporation.
- IBM and OS/2 are registered trademarks of International Business Machines.
- XGstudio and SoftSynthesizer are trademarks of Yamaha Corporation.
- Symbios is a registered trademark of Symbios Logic Corporation.
- Windows and MS-DOS are registered trademarks of Microsoft Corporation.
- Adobe and Acrobat are registered trademarks of Adobe Systems Incorporated.

The product name and revision number are both printed on the product itself. Manual revisions are released for each product design represented by the digit before and after the period of the manual revision number. Manual updates are represented by the third digit in the manual revision number.

For previous or updated manuals, BIOS, drivers, or product release information, contact ASUS at <http://www.asus.com.tw> or through any of the means indicated on the following page.

SPECIFICATIONS AND INFORMATION CONTAINED IN THIS MANUAL ARE FURNISHED FOR INFORMATIONAL USE ONLY, AND ARE SUBJECT TO CHANGE AT ANY TIME WITHOUT NOTICE, AND SHOULD NOT BE CONSTRUED AS A COMMITMENT BY ASUS. ASUS ASSUMES NO RESPONSIBILITY OR LIABILITY FOR ANY ERRORS OR INACCURACIES THAT MAY APPEAR IN THIS MANUAL, INCLUDING THE PRODUCTS AND SOFTWARE DESCRIBED IN IT.

**Copyright © 2000 ASUSTeK COMPUTER INC. All Rights Reserved.**

|                  |                       |
|------------------|-----------------------|
| Product Name:    | <b>ASUS CUW(E)-FX</b> |
| Manual Revision: | <b>1.01 E495</b>      |
| Release Date:    | <b>January 2000</b>   |

# ASUS CONTACT INFORMATION

---

## ASUSTeK COMPUTER INC. (Asia-Pacific)

### *Marketing*

Address: 150 Li-Te Road, Peitou, Taipei, Taiwan 112  
Telephone: +886-2-2894-3447  
Fax: +886-2-2894-3449  
Email: info@asus.com.tw

### *Technical Support*

MB/Others (Tel): +886-2-2890-7121 (English)  
Notebook (Tel): +886-2-2890-7122 (English)  
Desktop/Server (Tel): +886-2-2890-7123 (English)  
Fax: +886-2-2895-9254  
Email: tsd@asus.com.tw  
WWW: www.asus.com.tw  
FTP: ftp.asus.com.tw/pub/ASUS

## ASUS COMPUTER INTERNATIONAL (America)

### *Marketing*

Address: 6737 Mowry Avenue, Mowry Business Center, Building 2  
Newark, CA 94560, USA  
Fax: +1-510-608-4555  
Email: tmd1@asus.com

### *Technical Support*

Fax: +1-510-608-4555  
BBS: +1-510-739-3774  
Email: tsd@asus.com  
WWW: www.asus.com  
FTP: ftp.asus.com/Pub/ASUS

## ASUS COMPUTER GmbH (Europe)

### *Marketing*

Address: Harkortstr. 25, 40880 Ratingen, BRD, Germany  
Fax: +49-2102-442066  
Email: sales@asuscom.de (for marketing requests only)

### *Technical Support*

Hotline: MB/Others: +49-2102-9599-0 Notebook: +49-2102-9599-10  
Fax: +49-2102-9599-11  
Support (Email): www.asuscom.de/de/support (for online support)  
WWW: www.asuscom.de  
FTP: ftp.asuscom.de/pub/ASUSCOM

# CONTENTS

---

|                                                   |           |
|---------------------------------------------------|-----------|
| <b>1. INTRODUCTION .....</b>                      | <b>7</b>  |
| 1.1 How This Manual Is Organized .....            | 7         |
| 1.2 Item Checklist .....                          | 7         |
| <b>2. FEATURES .....</b>                          | <b>8</b>  |
| 2.1 The ASUS CUW(E)-FX Motherboard .....          | 8         |
| 2.1.1 Specifications .....                        | 8         |
| 2.1.2 Optional Components .....                   | 9         |
| 2.1.3 Performance .....                           | 10        |
| 2.1.4 Intelligence .....                          | 11        |
| 2.2 ASUS CUW(E)-FX Components .....               | 12        |
| 2.3 Component Locations .....                     | 13        |
| <b>3. HARDWARE SETUP .....</b>                    | <b>14</b> |
| 3.1 Motherboard Layout .....                      | 14        |
| 3.2 Layout Contents .....                         | 15        |
| 3.3 Hardware Setup Procedure .....                | 17        |
| 3.4 Motherboard Settings .....                    | 17        |
| 3.5 System Memory (DIMM) .....                    | 22        |
| 3.5.1 General DIMM Notes .....                    | 22        |
| 3.5.2 Memory Installation .....                   | 23        |
| 3.6 Central Processing Unit (CPU) .....           | 24        |
| 3.7 Expansion Cards .....                         | 25        |
| 3.7.1 Expansion Card Installation Procedure ..... | 25        |
| 3.7.2 Assigning IRQs for Expansion Cards .....    | 26        |
| 3.7.3 Audio Modem Riser (AMR) Slot .....          | 28        |
| 3.8 External Connectors .....                     | 29        |
| 3.9 Starting Up the First Time .....              | 41        |
| <b>4. BIOS SETUP .....</b>                        | <b>43</b> |
| 4.1 Managing and Updating Your BIOS .....         | 43        |
| 4.1.1 Upon First Use of the Computer System ..... | 43        |
| 4.1.2 Updating BIOS Procedures .....              | 44        |
| 4.2 BIOS Setup Program .....                      | 46        |
| 4.2.1 BIOS Menu Bar .....                         | 47        |
| 4.2.2 Legend Bar .....                            | 47        |
| 4.3 Main Menu .....                               | 49        |
| 4.3.1 Primary & Secondary Master/Slave .....      | 50        |
| 4.3.2 Keyboard Features .....                     | 54        |
| 4.4 Advanced Menu .....                           | 56        |
| 4.4.1 Chip Configuration .....                    | 60        |
| 4.4.2 I/O Device Configuration .....              | 63        |
| 4.4.3 PCI Configuration .....                     | 65        |
| 4.4.4 Shadow Configuration .....                  | 68        |

# CONTENTS

---

|              |                                           |            |
|--------------|-------------------------------------------|------------|
| 4.5          | Power Menu .....                          | 69         |
| 4.5.1        | Power Up Control .....                    | 71         |
| 4.5.2        | Hardware Monitor .....                    | 73         |
| 4.6          | Boot Menu .....                           | 74         |
| 4.7          | Exit Menu .....                           | 76         |
| <b>5.</b>    | <b>SOFTWARE SETUP .....</b>               | <b>79</b>  |
| 5.1          | Operating Systems .....                   | 79         |
| 5.2          | Starting Windows For the First Time ..... | 79         |
| 5.3          | ASUS Smart Motherboard Support CD .....   | 81         |
| 5.4          | LDCM Local Setup .....                    | 82         |
| 5.5          | LDCM Administrator Setup .....            | 84         |
| 5.6          | ASUS PC Probe .....                       | 87         |
| 5.7          | ASUS LiveUpdate .....                     | 88         |
| 5.8          | Drivers .....                             | 89         |
| 5.9          | Other .....                               | 90         |
| 5.10         | Uninstalling Programs .....               | 96         |
| <b>6.</b>    | <b>SOFTWARE REFERENCE .....</b>           | <b>99</b>  |
| 6.1          | Display Properties .....                  | 99         |
| 6.2          | ASUS PC Probe .....                       | 103        |
| 6.3          | ASUS LiveUpdate .....                     | 108        |
| 6.4          | Using Yamaha XGstudio Player .....        | 109        |
| 6.5          | Using Yamaha XGstudio Mixer .....         | 110        |
| 6.6          | Hardware Information .....                | 112        |
| <b>7.</b>    | <b>APPENDIX .....</b>                     | <b>113</b> |
| 7.1          | ASUS LCD-I Controller Module .....        | 113        |
| 7.2          | Modem Riser .....                         | 115        |
| 7.3          | Glossary .....                            | 117        |
| <b>INDEX</b> | <b>.....</b>                              | <b>121</b> |

# FCC & DOC COMPLIANCE

---

## ***Federal Communications Commission Statement***

This device complies with FCC Rules Part 15. Operation is subject to the following two conditions:

- This device may not cause harmful interference, and
- This device must accept any interference received, including interference that may cause undesired operation.

This equipment has been tested and found to comply with the limits for a Class B digital device, pursuant to Part 15 of the FCC Rules. These limits are designed to provide reasonable protection against harmful interference in a residential installation. This equipment generates, uses and can radiate radio frequency energy and, if not installed and used in accordance with manufacturer's instructions, may cause harmful interference to radio communications. However, there is no guarantee that interference will not occur in a particular installation. If this equipment does cause harmful interference to radio or television reception, which can be determined by turning the equipment off and on, the user is encouraged to try to correct the interference by one or more of the following measures:

- Re-orient or relocate the receiving antenna.
- Increase the separation between the equipment and receiver.
- Connect the equipment to an outlet on a circuit different from that to which the receiver is connected.
- Consult the dealer or an experienced radio/TV technician for help.

**WARNING!** Any changes or modifications to this product not expressly approved by the manufacturer could void any assurances of safety or performance and could result in violation of Part 15 of the FCC Rules.

Reprinted from the Code of Federal Regulations #47, part 15.193, 1993. Washington DC: Office of the Federal Register, National Archives and Records Administration, U.S. Government Printing Office.

## ***Canadian Department of Communications Statement***

This digital apparatus does not exceed the Class B limits for radio noise emissions from digital apparatus set out in the Radio Interference Regulations of the Canadian Department of Communications.

**This Class B digital apparatus complies with Canadian ICES-003.**

**Cet appareil numérique de la classe B est conforme à la norme NMB-003 du Canada.**

# 1. INTRODUCTION

## 1.1 How This Manual Is Organized

This manual is divided into the following sections:

- |                              |                                                  |
|------------------------------|--------------------------------------------------|
| 1) <b>INTRODUCTION</b>       | Manual information and checklist                 |
| 2) <b>FEATURES</b>           | Product information and specifications           |
| 3) <b>HARDWARE SETUP</b>     | Instructions on setting up the motherboard       |
| 4) <b>BIOS SETUP</b>         | Instructions on setting up the BIOS software     |
| 5) <b>SOFTWARE SETUP</b>     | Instructions on setting up the included software |
| 6) <b>SOFTWARE REFERENCE</b> | Reference material for the included software     |
| 7) <b>APPENDIX</b>           | Optional items and general reference             |

## 1.2 Item Checklist

Check that your package is complete. If you discover damaged or missing items, please contact your retailer.

### Package Contents

- (1) ASUS Motherboard
- (1) 40-pin 80-conductor ribbon cable for internal UltraDMA/66 or UltraDMA/33 IDE drives
- (1) 40-pin ribbon cable for internal UltraDMA/33 IDE drives
- (1) Ribbon cable for (1) 5.25" and (2) 3.5" floppy disk drives
- (1) Bag of spare jumper caps
- (1) Support CD with drivers and utilities
- (1) This Motherboard User's Manual

### Optional Items

- Serial port connector with bracket (optional)
- ASUS LCD-I controller module (for LCD model only)
- ASUS TV-out controller module (optional)
- ASUS IrDA-compliant infrared module (optional)
- ASUS consumer infrared set (optional)
- Modem riser card (optional)
- USB hub module (optional)

## 2. FEATURES

---

### 2.1 The ASUS CUW(E)-FX Motherboard

The CUW(E)-FX motherboard from ASUS is carefully designed for the demanding PC user who wants many smart features in a small package. So what's so smart about the ASUS CUW(E)-FX motherboard?

#### 2.1.1 Specifications

- **Latest Intel Socket 370 Processor Support!** Supports Intel's Pentium® III Coppermine and Celeron™ Mendocino processors.
- **Form Factor for Easy-to-Use PC!** Designed for small-size easy-to-use PCs. This new highly flexible form factor reduces the motherboard size by as much as 25% over the microATX design.
- **Latest Intel 810 Series Chipset!** Features Intel's 810 Series chipset with the Accelerated Hub Architecture, which provides direct connections between the 810 chipset and subsystems such as IDE controllers, USB controllers, and PCI add-on cards.
- **Integrated Graphics!** The 24-bit 230MHz RAMDAC graphics controller supports 3D hyper pipelined architecture, parallel data processing and compression, precise pixel interpolation, full 2D hardware acceleration, and motion video acceleration. The CUWE-FX comes with 4MB 32-bit 133MHz SDRAM display cache onboard, and the CUW-FX comes with *optional* 4MB 100MHz SDRAM display cache.
- **ASUS Graphics Driver!** You can gain about 12% performance over that of the standard graphics driver (2D high-end graphics WinMark) using ASUS' custom graphics driver. ASUS custom graphics driver also provides more features and provides selection of higher refresh rates and resolutions.
- **3D Positional Audio!** Brings new levels of realism to games with sounds being positioned interactively around the user, making them truly part of the 3D virtual experience. Better music reproduction is possible with MIDI utilizing Wavetable synthesis.
- **Versatile Memory Support!** DRAM controller supports asymmetrical addressing and two DIMM sockets support Intel PC100-compliant SDRAMs (16, 32, 64, 128, or 256MB) up to 512MB. (supports a maximum of 4 sides)
- **JumperFree™!** Allows processor settings and easy overclocking of frequency and Vcore voltage all through BIOS setup.
- **Legacy Free!** Provides one 32-bit PCI (rev 2.2) expansion slot with no ISA, eliminating bottlenecks and system memory management issues. PCI supports up to 133MB/s maximum throughput. Each PCI slot can support a Bus Master PCI card (such as SCSI or LAN cards).
- **Latest Low Pin Count Multi-I/O:** Provides two high-speed UART compatible serial ports and one parallel port with EPP and ECP capabilities.
- **Integrated IDE!** Controller supports UltraDMA/66 up to 66MB/s, UltraDMA/33 up to 33MB/s, and PIO Mode 4 up to 17MB/s.
- **Peripheral Wake-Up!** Supports Wake-On-LAN, Wake-On-Ring, Keyboard Wake-Up, and BIOS Wake-Up.



## 2. FEATURES

---

- **AMR Slot!** Audio Modem Riser slot supports a very affordable audio and/or modem riser card.
- **Around-the-Clock Intrusion Detection!** Chassis intrusion circuitry can log chassis panel open events into LDCM (available in near future for this motherboard). The onboard battery supports detection even when normal power is removed and through a new design, battery drain is even lower than the RTC used for keeping time!
- **Firmware Hub!** Provides security and other latest power computing features.
- **Monitoring for your PC's Health!** Provided ASUS PC Probe or Intel LDCM allows PC health monitoring.
- **Enhanced ACPI & Anti-Boot Virus Protection!** Programmable BIOS (Flash EEPROM), offering enhanced ACPI for Windows 98 compatibility, built-in firmware-based virus protection, and autodetection of most devices for virtually automatic setup.
- **Smart BIOS!** 4Mbit firmware gives a new easy-to-use interface which provides more control and protection over the motherboard. Provides Vcore and CPU/SDRAM frequency adjustments, boot block write protection, and HD/SCSI/MO/ZIP/CD/Floppy boot selection. Hardware random number generator supports new security software for data protection and secured Internet transactions.
- **Onboard LED!** The onboard LED will light up when there is standby power. This acts as a reminder to the user to turn OFF the power before plugging and unplugging devices so as not to damage the motherboard, peripherals, and/or components.

### 2.1.2 Optional Components

The following onboard components are optional at the time of purchase:

- **Smart Audio!** Software Audio and Hardware AC'97 V2.1 codec compliant with sample rate conversion from 7kHz to 48kHz. Full audio output can be directed to the chassis' internal speaker in order to save space and money while reducing complications associated with external speakers.
- **Smart Networking!** Features the Intel 82559 Fast-Ethernet LAN Controller (fully integrated 10BASE-T/100BASE-TX). Supports Wired for Management, remote wake-up, and OnNow initiative to reduce the Total Cost of Ownership (TCO).
- **Space Savings! Digital Flat Panel (DFP) Interface** (see *7.1 ASUS LCD-I Module*) gives a direct digital connection for connecting a **digital** flat panel (analog flat panel must be connected to the VGA-out connector) to your PC. This interface transmits sharp, bright images by eliminating digital-to-analog and analog-to-digital conversions, which can accumulate noise and degrade image quality.
- **TV Out!** Displays high quality graphics and video on any television (NTSC or PAL) with an optional TV Out module.
- **No Messy Wires!** Integrated Consumer IR and Serial IR supports an optional remote control package for wireless interfacing with external peripherals, personal gadgets, or an optional remote controller.
- **More USB Ports!** An optional USB hub module gives you a total of four USB ports for fast Plug-and-Play connection to your computer.

## 2. FEATURES

---

### 2.1.3 Performance

- **UltraPerformance!** Onboard IDE Bus Master controller with two connectors that support four IDE devices in two channels. Supports UltraDMA/66, UltraDMA/33 (IDE DMA Mode 2), PIO Modes 3 & 4, and supports Enhanced IDE devices, such as Tape Backup, DVD-ROM, CD-ROM, CD-R/RW, and LS-120 drives.
- **Double or Quadruple the IDE Transfer Speed!** IDE transfers using UltraDMA/33 Bus Master IDE can handle rates up to 33MB/s and up to 66MB/s using UltraDMA/66 technology. The best of all is that these new technology is compatible with existing ATA-2 IDE specifications so there is no need to upgrade current IDE devices or cables.
- **Concurrent PCI!** Concurrent PCI optimizes system performance with concurrent PCI and CPU bus activities.
- **SDRAM Optimized Performance!** ASUS smart series motherboards support the new generation memory, Synchronous Dynamic Random Access Memory (SDRAM), which increases the data transfer rate to 800MB/s max using PC100-compliant SDRAM.
- **ACPI Ready!** ACPI (Advanced Configuration and Power Interface) is also implemented on all ASUS smart series motherboards. ACPI provides more Energy Saving Features for future operating systems (OS) supporting OS Direct Power Management (OSPM) functionality. With these features implemented in the OS, PCs can be ready around the clock, yet satisfy all the energy saving standards. To fully utilize the benefits of ACPI, an ACPI-supported OS, such as Windows 98, must be used.
- **Suspend and Go!** Suspend-To-RAM (STR) provides maximum power savings as an alternative to leaving the computer ON and QuickStart™ so that you do not fall asleep waiting for system bootup.
- **New Complyancy!** Both the BIOS and hardware levels of the motherboard meet the stringent requirements for Microsoft PC'99 certification. The new PC'99 requirements for systems and components are based on the following high-level goals: Support for Plug and Play compatibility and power management for configuring and managing all system components, and 32-bit device drivers and installation procedures for Windows 95/98/NT. Color-coded connectors and descriptive icons make identification easy as required by PC'99.
- **Highest Audio Quality!** AC'97 DAC/ADC built into the audio CODEC reduces noise to improve audio quality and performance for a SNR (signal to noise ratio) of +90dB. These features greatly improve voice synthesis and recognition.
- **Extreme Graphics!** The integrated motion compensation allows for smooth MPEG1 or MPEG2 video playback. Fast 3D graphics engine allows for an exciting gameplay experience.

## 2. FEATURES

---

### 2.1.4 Intelligence

- **Fan Status Monitoring and Alarm!** To prevent system overheat and system damage, the CPU, power supply, and system fans can be monitored for RPM and failure. All the fans are set for its normal RPM range and alarm thresholds.
- **Temperature Monitoring and Alert!** To prevent system overheat and system damage, this motherboard supports Socket 370 processor thermal sensing and auto-protection.
- **Voltage Monitoring and Alert!** System voltage levels are monitored to ensure stable current to critical motherboard components. Voltage specifications are more critical for future processors, so monitoring is necessary to ensure proper system configuration and management.
- **System Resources Alert!** (Requires the future release of LDCM v6.0) Today's operating systems such as Windows 98, Windows NT, and OS/2, require much more memory and hard drive space to present enormous user interfaces and run large applications. The system resource monitor will warn the user before the system resources are used up to prevent possible application crashes. Suggestions will give the user information on managing their limited resources more efficiently.
- **Dual Function Power Button!** Through the BIOS, the power button can be defined as the "Standby" (a.k.a. Suspend or Sleep) button or as the Soft-Off (see ATX Power Switch Lead in **3.8 External Connectors** for more information) button. Regardless of the setting, pushing the power button for more than 4 seconds will enter the Soft-Off mode.
- **Remote Ring On (requires modem)!** This allows a computer to be turned on remotely through an internal or external modem. With this benefit on-hand, users can access any information from their computers from anywhere in the world!
- **Message LED (requires ACPI OS support)!** Message LEDs now act as information providers. Through the way a particular LED illuminates, the user can determine if a message has been received from a fax/modem. A simple glimpse provides useful information to the user. This function requires ACPI OS and driver support.
- **Peripheral Power Up!** Keyboard and/or CIR power up can be enabled or disabled through BIOS setup to allow the computer to be powered ON using your keyboard and/or Consumer IR device.

## 2. FEATURES

### 2.2 ASUS CUW(E)-FX Components

See the opposite page for locations.

|                            | Location                                                       |
|----------------------------|----------------------------------------------------------------|
| <b>Processor Support</b>   | Socket 370 for Coppermine/Mendocino Processors ..... 3         |
| <b>Chipsets</b>            | Intel 810 Series Chipset ..... 4                               |
|                            | Graphics and Memory Controller Hub (GMCH)                      |
|                            | Intel I/O Controller Hub (ICH) ..... 8                         |
|                            | 4Mb Firmware Hub (FWH) ..... 9                                 |
|                            | Low Pin Count Multi-I/O Chipset ..... 13                       |
| <b>Main Memory</b>         | Maximum 512MB support                                          |
|                            | 2 DIMM Sockets ..... 5                                         |
|                            | PC100 SDRAM support                                            |
| <b>Expansion Slots</b>     | 1 PCI Slot ..... 10                                            |
|                            | 1 Audio Modem Riser (AMR) Slot ..... 19                        |
| <b>System I/O</b>          | 1 USB Header ..... 1                                           |
|                            | 1 Floppy Disk Driver Connector ..... 6                         |
|                            | 2 IDE Connectors (UltraDMA33/66 Support) ..... 7               |
|                            | 1 Serial COM2 Header ..... 21                                  |
|                            | 1 Parallel Port Connector ..... 23                             |
|                            | 1 Serial COM1 Connector ..... 24                               |
|                            | 2 USB Connectors ..... (Bottom) 25                             |
|                            | 1 PS/2 Mouse Connector ..... (Top) 26                          |
|                            | 1 PS/2 Keyboard Connector ..... (Bottom) 26                    |
| <b>3D Graphics</b>         | Graphics and Memory Controller Hub (GMCH)                      |
|                            | 1 VGA Monitor Output Connector ..... 22                        |
|                            | TV-Out/Digital LCD Module Headers ..... 15                     |
|                            | 4MB onboard high-speed SDRAM (optional) ..... 12               |
| <b>Audio</b>               | AC'97 V2.1 Audio Codec ..... 18                                |
|                            | 1 Joystick/MIDI Connector ..... (Top) 20                       |
|                            | 1 Line Out Connector (on audio model only) ..... (Bottom) 20   |
|                            | 1 Line In Connector (on audio model only) ..... (Bottom) 20    |
|                            | 1 Microphone Connector (on audio model only) ... (Bottom) 20   |
| <b>Network Features</b>    | Intel 82559 Fast-Ethernet Chipset (on LAN model only) ..... 16 |
|                            | 1 LAN (RJ45) Connector (optional) ..... (Top) 25               |
|                            | Wake-On-LAN Connector ..... 17                                 |
|                            | Wake-On-Ring Connector ..... 14                                |
| <b>Hardware Monitoring</b> | System Voltage Monitoring (integrated in ASUS ASIC) ..... 11   |
|                            | 3 Fan Power and Speed Monitoring Connectors                    |
| <b>Power</b>               | ATX Power Supply Connector ..... 2                             |
| <b>Form Factor</b>         | FlexATX                                                        |

## 2. FEATURES

### 2.3 Component Locations

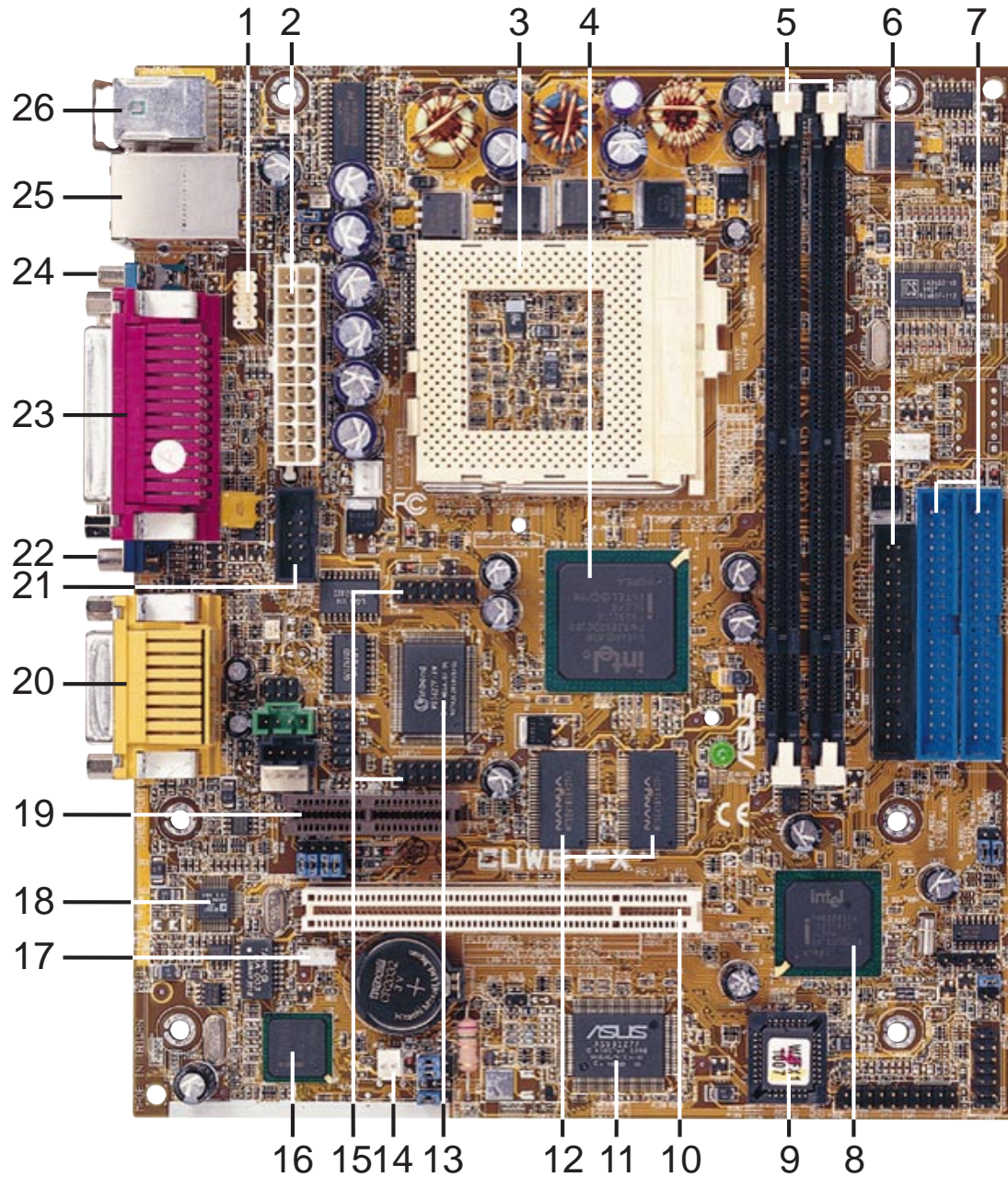

2. FEATURES  
Component Locations

# 3. HARDWARE SETUP

## 3.1 Motherboard Layout

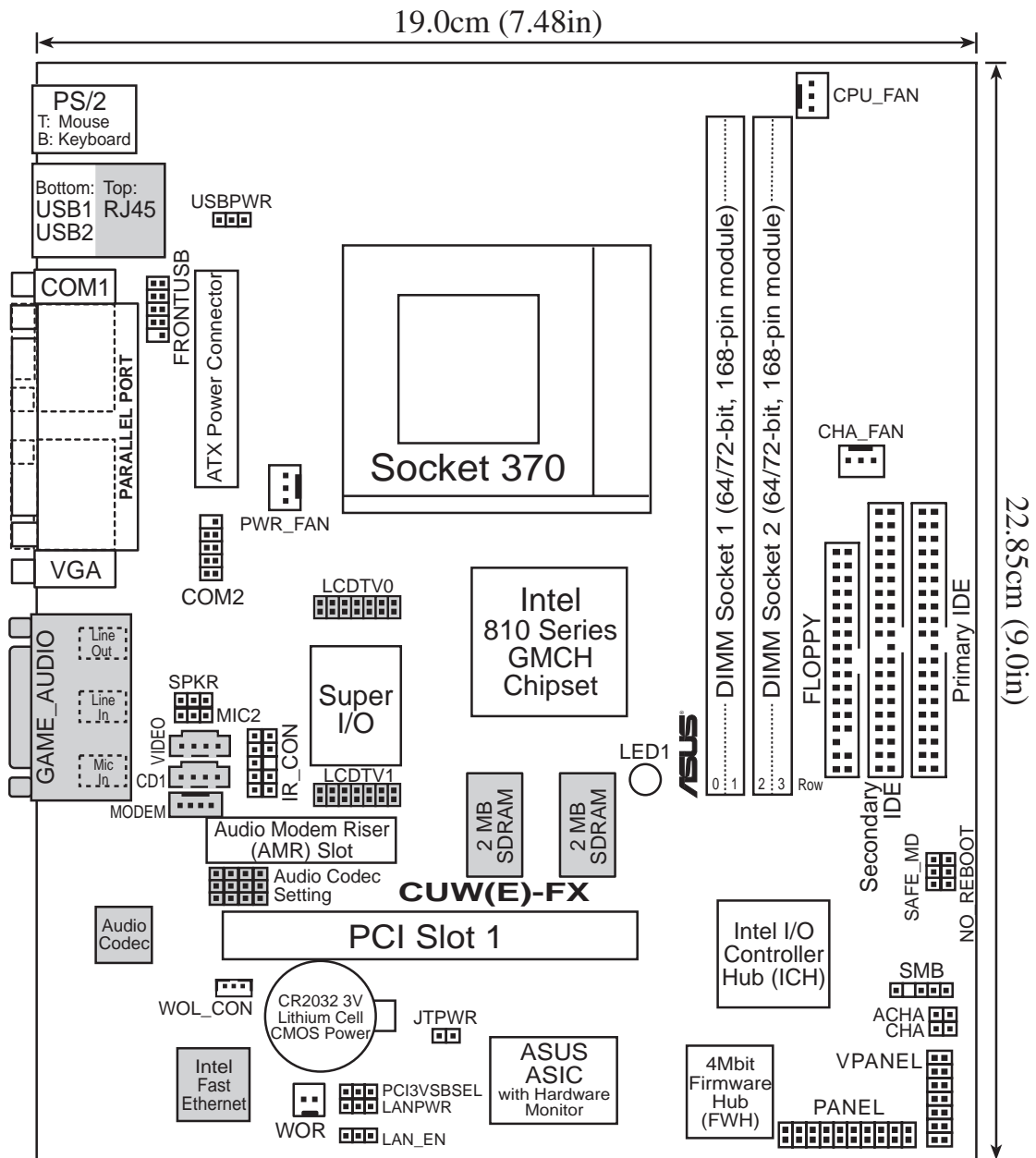

(Grayed items are optional at the time of purchase.)

3. HW/SETUP  
Motherboard Layout

# 3. HARDWARE SETUP

## 3.2 Layout Contents

### Motherboard Settings

- |               |                                                   |
|---------------|---------------------------------------------------|
| 1) CODEC      | p.18 Onboard Audio Codec Setting (Enable/Disable) |
| 2) PCI3VSBSEL | p.18 PCI 3Volt Setting (+3 VSB/+3 Volt)           |
| 3) SAFE_MD    | p.19 Safe Mode (Disable/Safe Mode)                |
| 4) NO_REBOOT  | p.19 Automatic Timeout Reboot (Disable/No Reboot) |
| 5) LAN_EN     | p.20 Onboard LAN Setting (Enable/Disable)         |
| 6) LANPWR     | p.20 Onboard LAN Power Setting (+3 Volt/+3 VSB)   |
| 7) USBPWR     | p.21 USB Power Up (+5Volt/+5VSB)                  |

### Expansion Slots

- |                 |                                           |
|-----------------|-------------------------------------------|
| 1) DIMM1, DIMM2 | p.23 168-Pin DIMM Memory Support          |
| 2) Socket 370   | p.24 Central Processing Unit (CPU) Socket |
| 4) PCI1         | p.25 32-bit PCI Bus Expansion Slots       |
| 5) AMR          | p.28 Audio Modem Riser Slot               |

### Connectors

- |                                  |                                                              |
|----------------------------------|--------------------------------------------------------------|
| 1) PS2KBMS                       | p.29 PS/2 Mouse Connector (6-pin female)                     |
| 2) PS2KBMS                       | p.29 PS/2 Keyboard Connector (6-pin female)                  |
| 3) USB                           | p.30 Universal Serial Bus Ports 1 & 2 (Two 4-pin female)     |
| 4) PRINTER                       | p.30 Parallel Port Connector (25-pin female)                 |
| 5) COM1                          | p.30 Serial Port COM1 Connector (9-pin male)                 |
| 6) VGA                           | p.31 Monitor (VGA) Output Connector (15-pin female)          |
| 7) GAME_AUDIO                    | p.31 Joystick/MIDI Connector (15-pin female)(optional)       |
| 8) GAME_AUDIO                    | p.31 Audio Port Connectors (Three 1/8" female)(optional)     |
| 9) RJ45                          | p.31 Fast-Ethernet Port Connector (RJ45) (optional)          |
| 10) PRIMARY IDE<br>SECONDARY IDE | p.32 Primary/Secondary IDE Connectors (Two 40-1pins)         |
| 11) FLOPPY                       | p.32 Floppy Disk Drive Connector (34-1pins)                  |
| 12) WOL_CON                      | p.33 Wake-On-LAN Connector (3 pins)                          |
| 13) WOR                          | p.33 Wake-On-Ring Connector (2 pins)                         |
| 14) IDELED                       | p.34 IDE Activity LED Lead (2 pins)                          |
| 15) CHA_, CPU_, PWR_FAN          | p.34 Chassis, CPU, Power Supply Fan Connectors (Three 3-pin) |
| 16) IR_CON                       | p.35 Infrared Module Connectors (10-1 pins)                  |
| 17) COM2                         | p.35 Serial COM2 Port Header (10-1 pins)                     |
| 18) SMB                          | p.36 SMBus Connector (5-1 pins)                              |
| 19) LCDTV0/LCDTV1                | p.36 LCD-TV Headers (Two 14 pins) (optional)                 |
| 20) MIC2                         | p.36 Internal Microphone Connector (3 pins)                  |
| 21) VIDEO/CD1/MODEM              | p.37 Internal Audio Connectors (Three 4-pins)                |

## 3. HARDWARE SETUP

---

|                     |                                                       |
|---------------------|-------------------------------------------------------|
| 22) FRONTUSB        | p.37 Front Panel USB Header (10-1 pin block)          |
| 23) SPKR            | p.38 Headphone True-Level Line Out Header (3-pins)    |
| 24) ACHA            | p.38 Chassis Intrusion Lead (2-pins)                  |
| 25) ATXPWR          | p.39 ATX Power Supply Connector (20 pins)             |
| 26) JTPWR           | p.39 Thermal Sensor Connector (2 pins)                |
| 27) KEYLOCK (PANEL) | p.40 System Power LED Lead (3-1 pins)                 |
| 28) KEYLOCK (PANEL) | p.40 Keyboard Lock Switch Lead (2 pins)               |
| 29) SPEAKER (PANEL) | p.40 System Warning Speaker Connector (4 pins)        |
| 30) RESET (PANEL)   | p.40 Reset Switch Lead (2 pins)                       |
| 31) PWR (PANEL)     | p.40 ATX Power / Soft-Off Switch Lead (2 pins)        |
| 32) SMI (PANEL)     | p.40 System Management Interrupt Switch Lead (2 pins) |
| 33) LED (PANEL)     | p.40 System Message LED (2 pins)                      |



# 3. HARDWARE SETUP

---

## 3.3 Hardware Setup Procedure

Before using your computer, you must complete the following steps:

- **Check Motherboard Settings**
- **Install Memory Modules**
- **Install the Central Processing Unit (CPU)**
- **Install Expansion Cards**
- **Connect Ribbon Cables, Panel Wires, and Power Supply**

**WARNING!** Make sure that you unplug your power supply when adding or removing system components. Failure to do so may cause severe damage to your motherboard, peripherals, and/or components. The onboard LED (see **3.1 Motherboard Layout** for location) when lit acts as a reminder that the system is in suspend or soft-off mode and not powered OFF.

## 3.4 Motherboard Settings

This section explains in detail how to change your motherboard's function settings through the use of switches and/or jumpers.

**WARNING!** Computer motherboards and expansion cards contain very delicate Integrated Circuit (IC) chips. To protect them against damage from static electricity, you should follow some precautions whenever you work on your computer.

1. Unplug your computer when working on the inside.
2. Use a grounded wrist strap before handling computer components. If you do not have one, touch both of your hands to a safely grounded object or to a metal object, such as the power supply case.
3. Hold components by the edges and try not to touch the IC chips, leads or connectors, or other components.
4. Place components on a grounded antistatic pad or on the bag that came with the component whenever the components are separated from the system.

# 3. HARDWARE SETUP

## 1) Onboard Audio Codec Setting (CODEC)

*available on audio model only*

The onboard audio CODEC may be enabled or disabled using all of these jumpers. Disable the onboard audio CODEC if you are using a PCI audio card on any of the expansion slots or a primary AMR on the AMR slot (see AMR Slot later in this section). If using a PCI audio expansion card, **Onboard AC'97 Audio Controller** in **4.4.2 I/O Device Configuration** must also be disabled.

| Setting | CODEC                             |
|---------|-----------------------------------|
| Enable  | [1-2] [1-2] [1-2] [1-2] (default) |
| Disable | [2-3] [2-3] [2-3] [2-3]           |

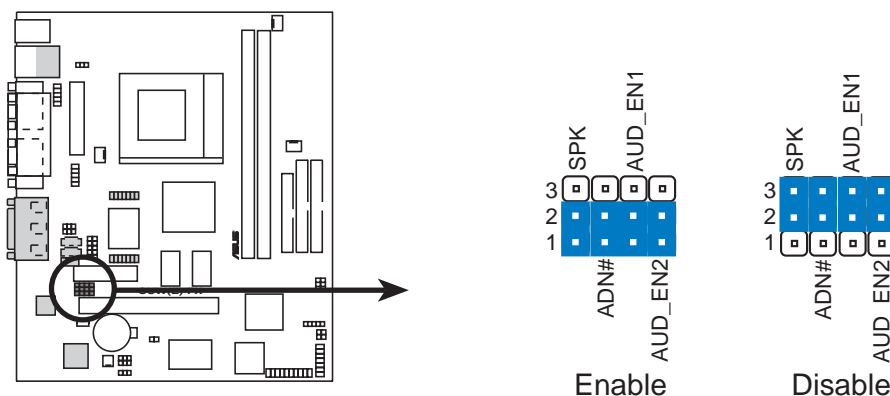

**CUW(E)-FX Audio Codec Setting**

## 2) PCI 3 Volt Setting (PCI3VSBSEL)

This jumper allows you to select the voltage supplied to PCI devices. If you have PCI devices that require auxiliary power, set this jumper to *Enable 3 VSB*.

| Setting | PCI3VSBSEL      |
|---------|-----------------|
| +3 VSB  | [1-2] (default) |
| +3 Volt | [2-3]           |

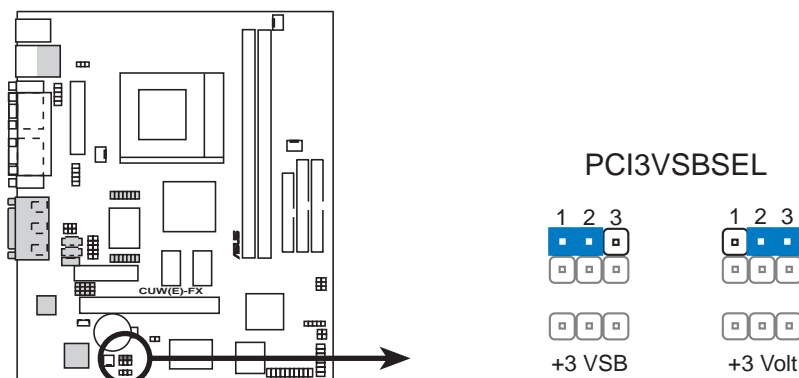

**CUW(E)-FX PCI 3 Volt Selection**

# 3. HARDWARE SETUP

## 3) Safe Mode Setting (SAFE\_MD)

Usually socket 370 processors have locked frequency multiples. In this case, there is no way to exceed the specified multiple whether through motherboard settings or BIOS setup. With unlocked socket 370 processors, exceeding the specified multiple is possible through BIOS setup. Exceeding the specified multiple may result in hanging during bootup. If this occurs, enable Safe Mode to force a multiple of 2 in order to enter BIOS setup to correct the problem.

| <u>Setting</u> | <u>SAFE MD</u>  |
|----------------|-----------------|
| Disable        | [1-2] (default) |
| Safe Mode      | [2-3]           |

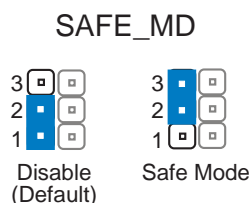
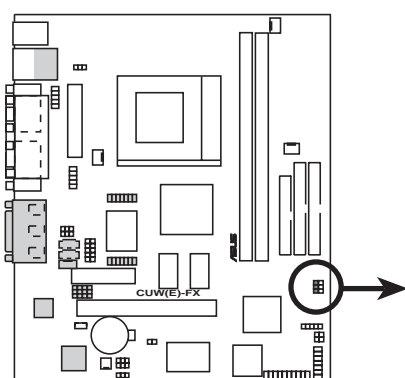

CUW(E)-FX Safe Mode Setting

## 4) Automatic Timeout Reboot Setting (NO\_REBOOT)

The motherboard is set so that when the BIOS detects a hang (timeout) during bootup, the motherboard will automatically reboot. If rebooting is repeating ineffectively, set this jumper to *No Reboot* to disable auto-reboot.

| <u>Setting</u> | <u>NO REBOOT</u> |
|----------------|------------------|
| Disable        | [1-2] (default)  |
| No Reboot      | [2-3]            |

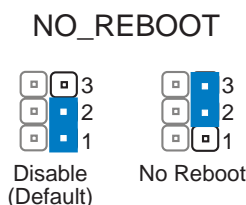
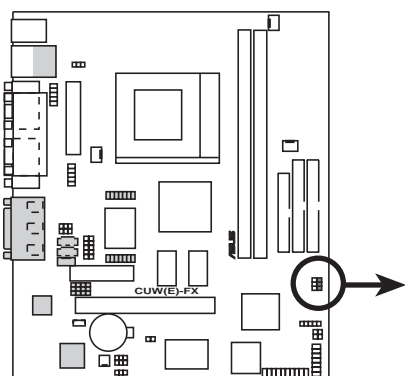

CUW(E)-FX Reboot Setting

# 3. HARDWARE SETUP

## 5) Onboard LAN Setting (LAN\_EN)

The onboard LAN may be enabled/disabled with this jumper.

| Setting | LAN_EN          |
|---------|-----------------|
| Enable  | [1-2] (default) |
| Disable | [2-3]           |

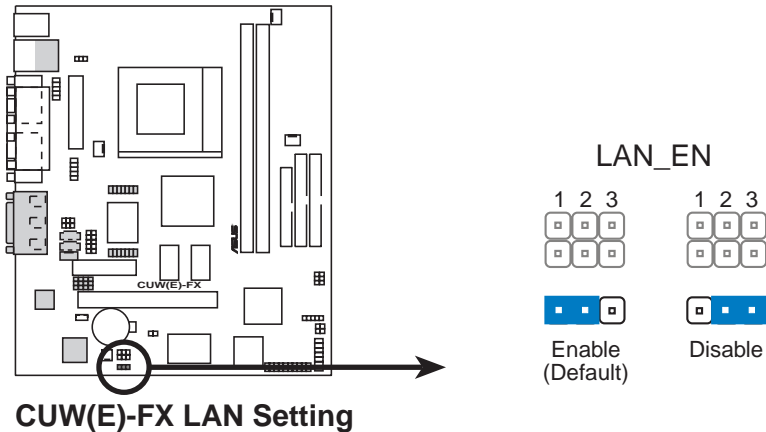

CUW(E)-FX LAN Setting

## 6) Onboard LAN Power Setting (LANPWR)

The onboard LAN power may be set to +3 Volt or +3 VSB. Select **+3 Volt** if you do not have a power supply with 720mA standby power. Selecting **+3 VSB** will allow the use of Wake-on-LAN but may not allow system wakeup if the power supply's standby power is insufficient.

| Setting | LANPWR          |
|---------|-----------------|
| +3 Volt | [2-3] (default) |
| +3 VSB  | [1-2]           |

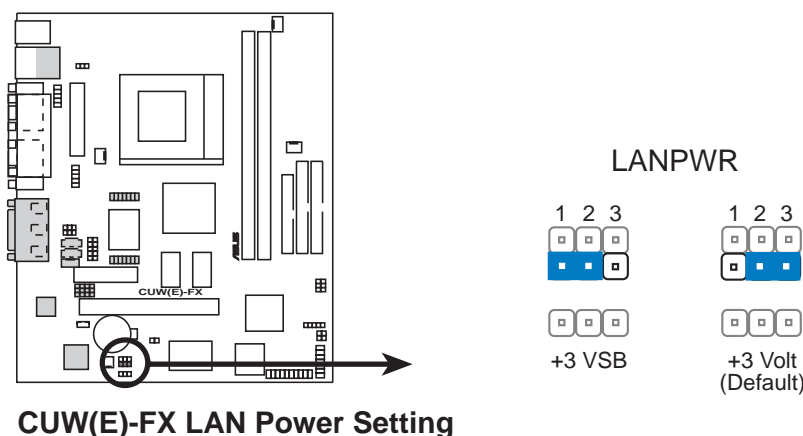

CUW(E)-FX LAN Power Setting

# 3. HARDWARE SETUP

## 7) USB Power Selection (USBPWR)

The USB power may be set to +5Volt or +5VSB. Select **+5 Volt** if you do not have a power supply with 1A standby power. Selecting **+5 VSB** will allow wakeup by USB keyboard if the power supply's standby power is sufficient.

| <u>Setting</u> | <u>USBPWR</u>   |
|----------------|-----------------|
| +5 Volt        | [1-2] (default) |
| +5 VSB         | [2-3]           |

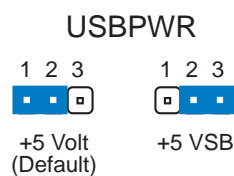
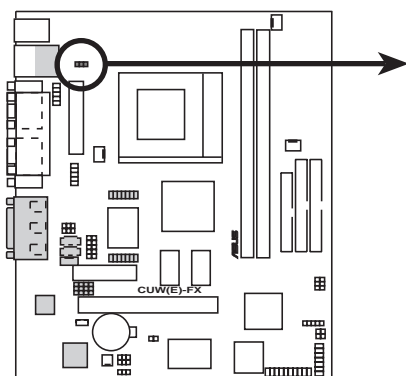

CUW(E)-FX USB Power Selection

## 3. HARDWARE SETUP

### 3.5 System Memory (DIMM)

**NOTE:** No hardware or BIOS setup is required after adding or removing memory.

This motherboard uses only Dual Inline Memory Modules (DIMMs). Sockets are available for **3.3Volt** (power level) unbuffered Synchronous Dynamic Random Access Memory (SDRAM) of 16, 32, 64, 128MB, or 256MB (512MB maximum system memory using 128Mb technology).

This chipset does not support ECC. However, ECC memory modules may still be used, but the ECC function will not be available.

Memory speed setup is recommended through **SDRAM Configuration** in *4.4.1 Chip Configuration*.

*Install memory in any combination as follows:*

| Location            | 168-pin DIMM SDRAM                                       |    | Total Memory |
|---------------------|----------------------------------------------------------|----|--------------|
| DIMM1<br>(Rows 0&1) | Single-Sided/Double-Sided<br>16, 32, 64, 128MB, or 256MB | x1 |              |
| DIMM2<br>(Rows 2&3) | Single-Sided/Double-Sided<br>16, 32, 64, 128MB, or 256MB | x1 |              |
|                     | <b>Total System Memory (Max 512MB)</b>                   | =  |              |

**NOTE:** Using 2x2x2 SDRAM can greatly improve the onboard graphics' performance.

#### 3.5.1 General DIMM Notes

- ASUS motherboards support SPD (Serial Presence Detect) DIMMs. This is the memory of choice for best performance vs. stability.
- SDRAM chips are generally thinner with higher pin density than EDO (Extended Data Output) chips.
- BIOS shows SDRAM memory on bootup screen.
- Single-sided DIMMs come in 16, 32, 64, 128MB; double-sided come in 32, 64, 128, 256MB.

# 3. HARDWARE SETUP

## 3.5.2 Memory Installation

**WARNING!** Make sure that you unplug your power supply when adding or removing memory modules or other system components. Failure to do so may cause severe damage to both your motherboard and expansion cards (see **3.3 Hardware Setup Procedure** for more information).

Insert the module(s) as shown. Because the number of pins are different on either side of the breaks, the module will only fit in the orientation shown. DIMM modules are longer and have different pin contact on each side and therefore have a higher pin density. SIMMs have the same pin contact on both sides.

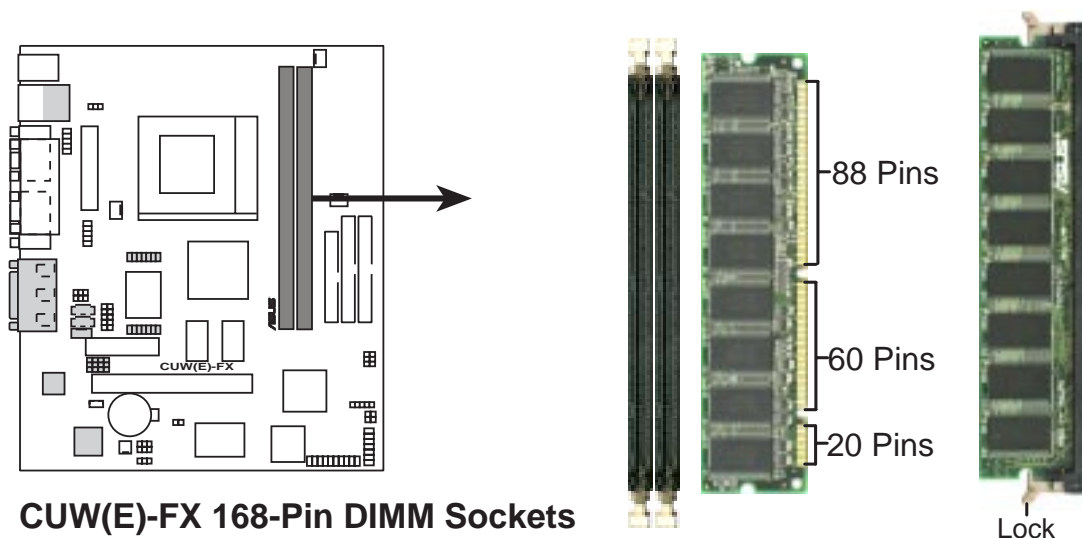

**CUW(E)-FX 168-Pin DIMM Sockets**

3. HW SETUP  
System Memory

The DIMMs must be **3.3V Unbuffered** for this motherboard. To determine the DIMM type, check the notches on the DIMMs (see figure below).

### 168-Pin DIMM Notch Key Definitions (3.3V)

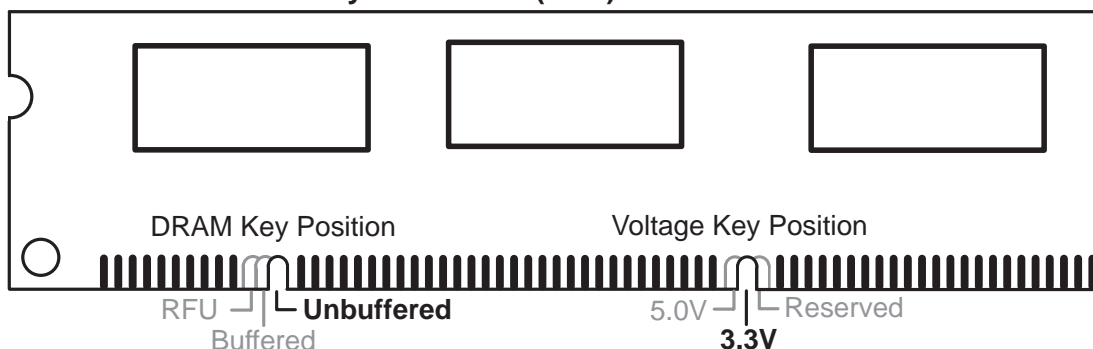

The notches on the DIMM will shift between left, center, or right to identify the type and also to prevent the wrong type from being inserted into the DIMM slot on the motherboard. You must ask your retailer the correct DIMM type before purchasing. This motherboard supports four clock signals per DIMM slot.

# 3. HARDWARE SETUP

## 3.6 Central Processing Unit (CPU)

The motherboard provides a ZIF Socket 370. The CPU that came with the motherboard should have a fan attached to it to prevent overheating. If this is not the case, then purchase a fan before you turn on your system.

**WARNING!** Be sure that there is sufficient air circulation across the processor's heatsink by regularly checking that your CPU fan is working. Without sufficient circulation, the processor could overheat and damage both the processor and the motherboard. You may install an auxiliary fan, if necessary.

To install a CPU, first turn off your system and remove its cover. Locate the ZIF socket and open it by first pulling the lever sideways away from the socket then upwards to a 90-degree angle. Insert the CPU with the correct orientation as shown. The notched corner should point towards the end of the lever. Because the CPU has a corner pin for two of the four corners, the CPU will only fit in the orientation as shown. The picture is for reference only; you should have a CPU fan that covers the face of the CPU. With the added weight of the CPU fan, no force is required to insert the CPU. Once completely inserted, close the socket's lever while holding down the CPU.

**NOTE:** Do not forget to set the correct Bus Frequency and Multiple (frequency multiple setting is available only on unlocked processors) for your Socket 370 processor or else boot-up may not be possible. Socket 370 processors provide internal thermal sensing so that a socket mounted thermal resistor is not needed.

**CAUTION!** Be careful not to scrape the motherboard when mounting a clamp-style processor fan or else damage may occur to the motherboard.

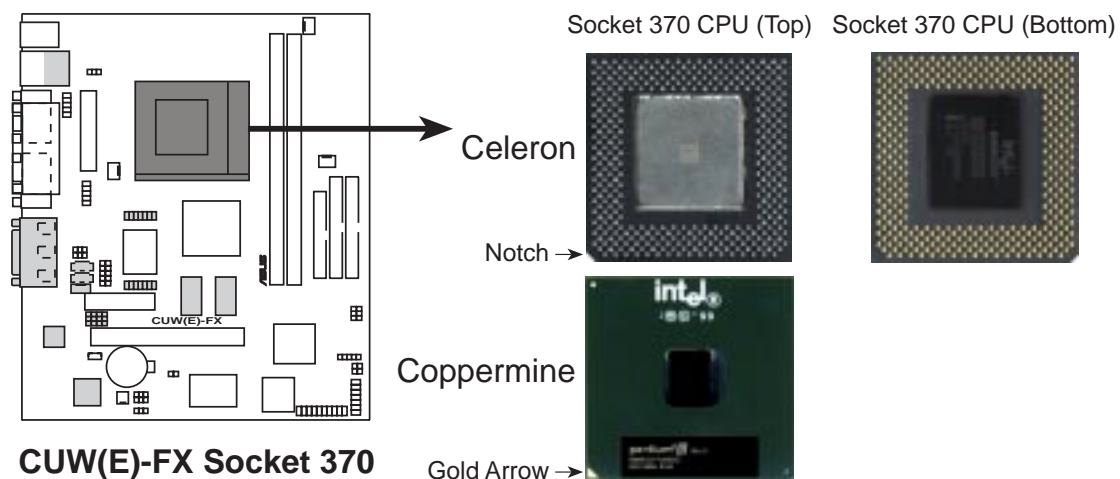



# 3. HARDWARE SETUP

## 3.7 Expansion Cards

**WARNING!** Make sure that you unplug your power supply when adding or removing expansion cards or other system components. Failure to do so may cause severe damage to both your motherboard and expansion cards (see **3.3 Hardware Setup Procedure** for more information).

### 3.7.1 Expansion Card Installation Procedure

1. Read the documentation for your expansion card and make any necessary hardware or software settings for your expansion card, such as jumpers or switches.
2. Remove your computer system's cover and the bracket plate with screw on the slot you intend to use. Keep the bracket for possible future use.
3. Carefully align the card's connectors and press firmly.
4. Secure the card on the slot with the screw you removed above.
5. Replace the computer system's cover.
6. Set up the BIOS if necessary  
(such as *IRQ xx Used By ISA: Yes* in PNP AND PCI SETUP)
7. Install the necessary software drivers for your expansion card.

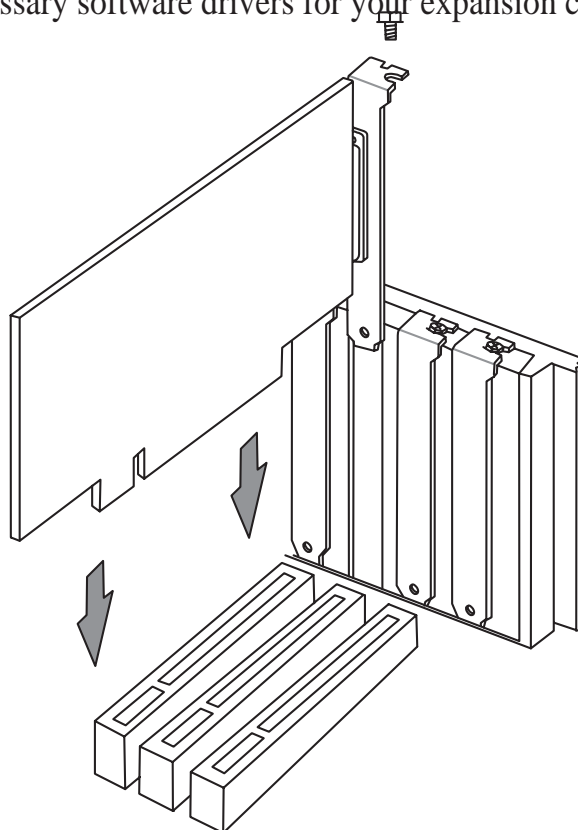

# 3. HARDWARE SETUP

## 3.7.2 Assigning IRQs for Expansion Cards

Some expansion cards need an IRQ to operate. Generally, an IRQ must be exclusively assigned to one use. In a standard design, there are 16 IRQs available but most of them are already in use, leaving 6 IRQs free for expansion cards. If your motherboard has **PCI** audio onboard, an additional IRQ will be used. If your motherboard also has **MIDI** enabled, another IRQ will be used, leaving 4 IRQs free.

The following table lists the default IRQ assignments for standard PC devices. Use this table when configuring your system and for resolving IRQ conflicts.

### *Standard Interrupt Assignments*

| IRQ | Priority | Standard Function           |
|-----|----------|-----------------------------|
| 0   | 1        | System Timer                |
| 1   | 2        | Keyboard Controller         |
| 2   | N/A      | Programmable Interrupt      |
| 3*  | 11       | Communications Port (COM2)  |
| 4*  | 12       | Communications Port (COM1)  |
| 5*  | 13       | Sound Card (sometimes LPT2) |
| 6   | 14       | Floppy Disk Controller      |
| 7*  | 15       | Printer Port (LPT1)         |
| 8   | 3        | System CMOS/Real Time Clock |
| 9*  | 4        | ACPI Mode when enabled      |
| 10* | 5        | IRQ Holder for PCI Steering |
| 11* | 6        | IRQ Holder for PCI Steering |
| 12* | 7        | PS/2 Compatible Mouse Port  |
| 13  | 8        | Numeric Data Processor      |
| 14* | 9        | Primary IDE Channel         |
| 15* | 10       | Secondary IDE Channel       |

\*These IRQs are usually available for ISA or PCI devices.

## 3. HARDWARE SETUP

---

### *Interrupt Request Table*

|                         | INT-A  | INT-B      | INT-C | INT-D      |
|-------------------------|--------|------------|-------|------------|
| PCI slot 1              | shared | --         | --    | --         |
| Onboard VGA             | shared | ----       | --    | --         |
| Onboard Audio/AMR/SMBus | --     | not shared | --    | --         |
| USB                     | --     | --         | --    | not shared |

**IMPORTANT:** If using PCI cards on shared slots, make sure that the drivers support “Share IRQ” or that the cards do not need IRQ assignments. Conflicts will arise between the two PCI groups that will make the system unstable or cards inoperable.

# 3. HARDWARE SETUP

## 3.7.3 Audio Modem Riser (AMR) Slot

This connector supports a specially designed audio and/or modem card called an AMR. Main processing is done through software and controlled by the motherboard's Intel I/O Controller Hub (ICH). This provides an upgradeable audio and/or modem solution at an incredibly low cost. There are two types of AMR, one defined as primary and another defined as secondary. This motherboard uses the primary channel so that a secondary AMR can coexist without the need to disable the optional onboard CODEC. The motherboard's onboard CODEC (on audio model only) must be disabled when using a primary AMR.

**NOTE:** An AMR is not included with this motherboard.

**WARNING!** Make sure that you unplug your power supply when adding or removing an AMR or other system components. Failure to do so may cause severe damage to both your motherboard and expansion cards (see **3.3 Hardware Setup Procedure** for more information).

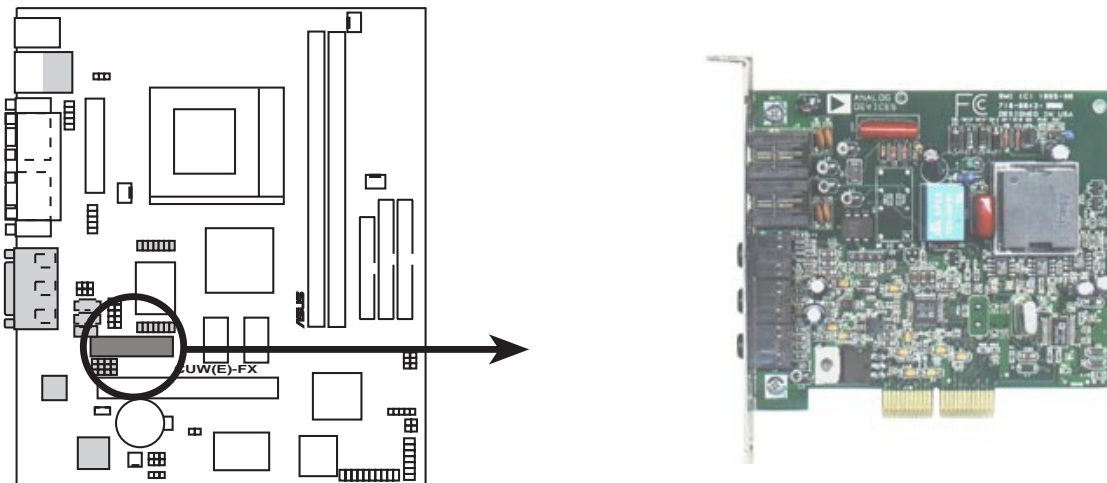

**CUW(E)-FX Audio Modem Riser (AMR) Connector**

# 3. HARDWARE SETUP

## 3.8 External Connectors

**WARNING!** Some pins are used for connectors or power sources. These are clearly distinguished from jumpers in the Motherboard Layout. Placing jumper caps over these connector pins will cause damage to your motherboard.

**IMPORTANT:** Ribbon cables should always be connected with the red stripe to Pin 1 on the connectors. Pin 1 is usually on the side closest to the power connector on hard drives and CD-ROM drives, but may be on the opposite side on floppy disk drives. Check the connectors before installation because there may be exceptions. Look on IDE ribbon cable must be less than 46 cm (18 in.), with the second drive connector no more than 15 cm (6 in.) from the first connector.

**NOTE:** Onboard Fast-Ethernet is optional at the time of purchase. The fast ethernet port connector is available only on the LAN model. The illustrations below are that of the model without the onboard Fast-Ethernet.

### 1) PS/2 Mouse Connector (Green 6-pin PS2KBMS)

The system will direct IRQ12 to the PS/2 mouse if one is detected. If one is not detected, expansion cards can use IRQ12. See **PS/2 Mouse Function Control** in *4.4 Advanced Menu*.

PS/2 Mouse (6-pin female)

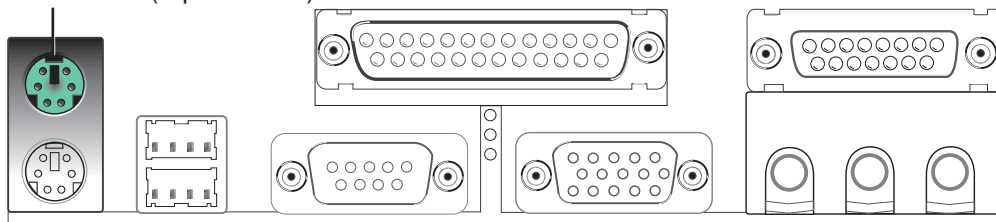

### 2) PS/2 Keyboard Connector (Purple 6-pin PS2KBMS)

This connection is for a standard keyboard using an PS/2 plug (mini DIN). **This connector will not allow standard AT size (large DIN) keyboard plugs. You may use a DIN to mini DIN adapter on standard AT keyboards.**

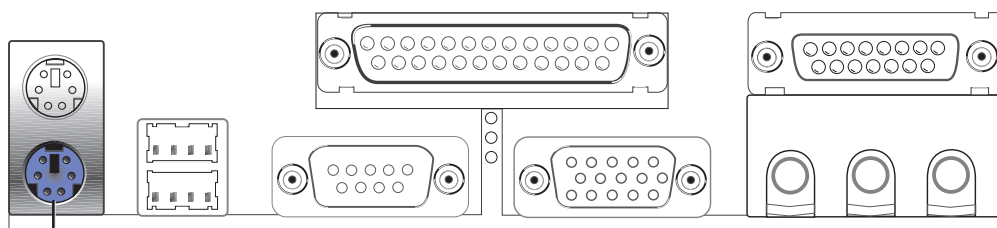

PS/2 Keyboard (6-pin female)

# 3. HARDWARE SETUP

## 3) Universal Serial Bus Ports 1 & 2 (Two Black 4-pin USB)

Two back panel USB ports are provided for connecting USB devices. If you prefer to use front panel USB ports, you can connect an external connector set to the USB header and mount it on the front panel (see *Front Panel USB Header* later in this section). **NOTE:** The back panel and front panel ports cannot be used at the same time.

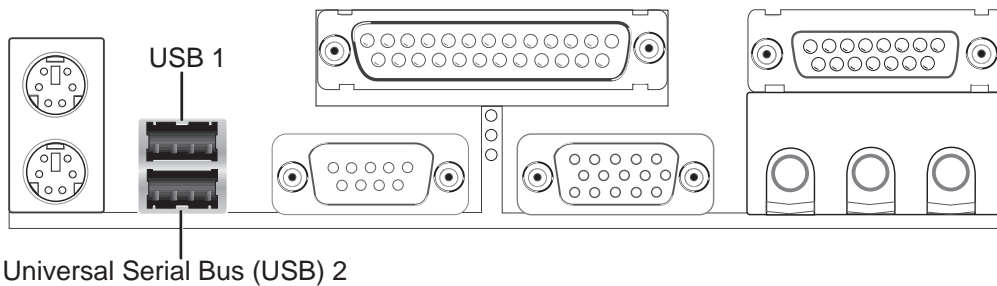

## 4) Parallel Port Connector (Burgundy 25-pin PRINTER)

You can enable the parallel port and choose the IRQ through **Onboard Parallel Port** (see *4.4.2 I/O Device Configuration*).

**NOTE:** Serial printers must be connected to the serial port.

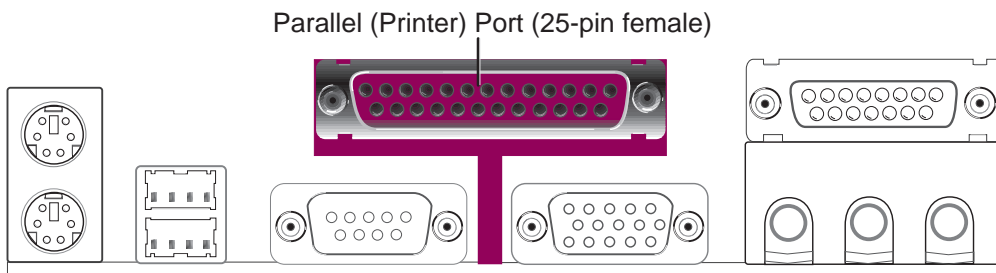

## 5) Serial Port COM1 Connector (Teal/Turquoise 9-pin COM1)

One serial port is ready for a mouse or other serial devices. A second serial port is available using a serial port bracket connected from the motherboard to an expansion slot opening. See **Onboard Serial Port 1** in *4.2.2 I/O Device Configuration* for settings.

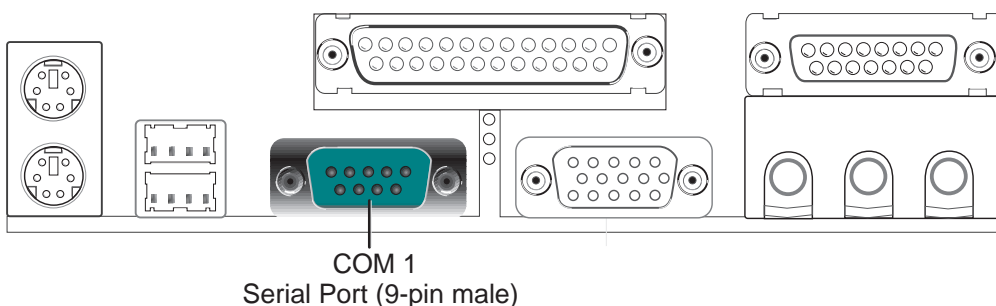

# 3. HARDWARE SETUP

## 6) Monitor Output Connector (Blue 15-pin VGA)

This connector is for output to a VGA-compatible device.

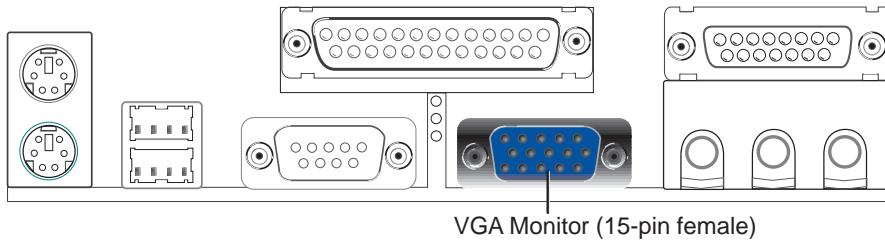

## 7) Joystick/MIDI Connector (Gold 15-pin GAME\_AUDIO) (optional)

You may connect game joysticks or game pads to this connector for playing games. Connect MIDI devices for playing or editing professional audio.

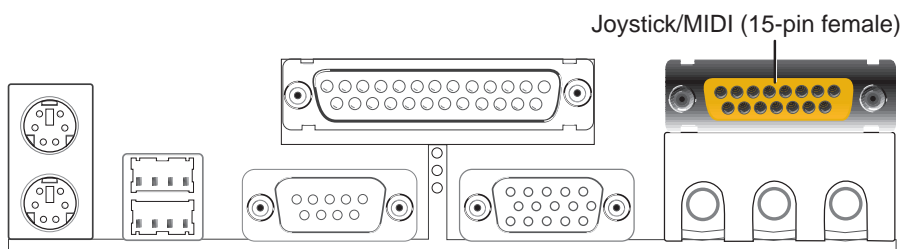

**NOTE:** The onboard game port is to be used only if you are not using any PCI or ISA audio card with a game port.

## 8) Audio Port Connectors (Three 1/8" GAME\_AUDIO) (optional)

**Line Out** (lime) can be connected to headphones or preferably powered speakers. **Line In** (light blue) allows tape players or other audio sources to be recorded by your computer or played through the **Line Out** (lime). **Mic** (pink) allows microphones to be connected for inputting voice.

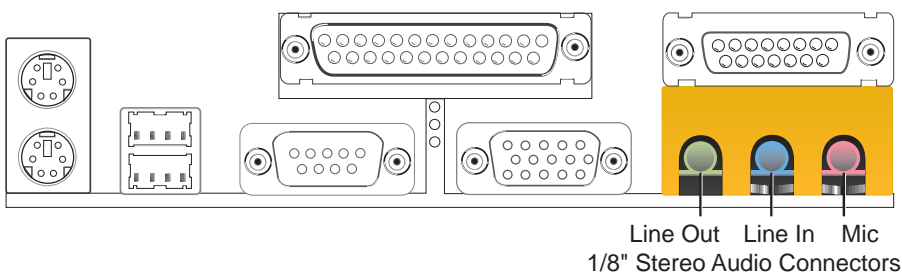

## 9) Fast-Ethernet Port Connector (RJ45) (optional)

The RJ45 connector is optional at the time of purchase and is located on top of the USB connectors. The connector allows the motherboard to connect to a Local Area Network (LAN) through a network hub.

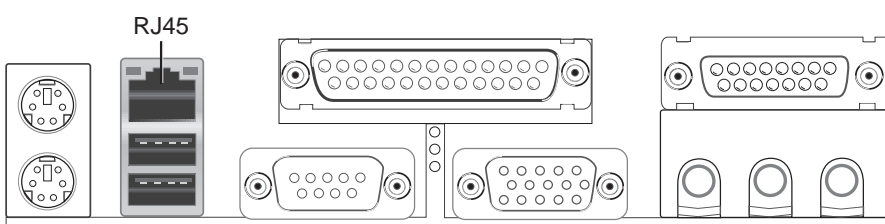

# 3. HARDWARE SETUP

## 10) Primary / Secondary IDE Connectors (40-1 pin PRIMARY/SECONDARY)

These connectors support the provided UltraDMA/66 IDE hard disk ribbon cable. Connect the cable's blue connector to the motherboard's primary (recommended) or secondary IDE connector, and then connect the gray connector to your UltraDMA/66 slave device (hard disk drive) and the black connector to your UltraDMA/66 master device. It is recommended that non-UltraDMA/66 devices be connected to the secondary IDE connector. If you install two hard disks, you must configure the second drive to Slave mode by setting its jumper accordingly. Refer to your hard disk documentation for the jumper settings. BIOS now supports specific device bootup (see **Boot Sequence** in *4.6 Boot Menu*). **(Pin 20 is removed to prevent inserting in the wrong orientation when using ribbon cables with pin 20 plugged).** If you have more than two UltraDMA/66 devices, you will need to purchase another UltraDMA/66 cable.

**NOTE:** A small hole near the blue connector on the UltraDMA/66 cable is intentional.

**TIP:** You may configure two hard disks to be both Masters with two ribbon cables – one for the primary IDE connector and another for the secondary IDE connector. You may install one operating system on an IDE drive and another on a SCSI drive and select the boot disk through **Boot Sequence** in *4.6 Boot Menu*.

**WARNING!** UltraDMA/66 IDE devices must use an 80-conductor IDE cable.

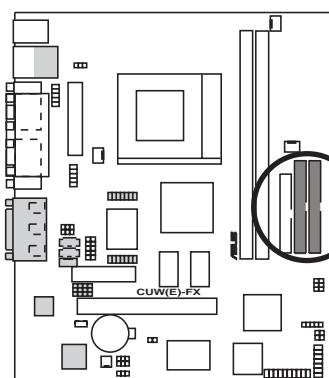

CUW(E)-FX IDE Connectors

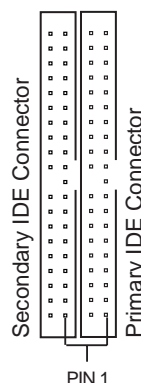

**NOTE:** Orient the red markings (usually zigzag) on the IDE ribbon cable to PIN 1

## 11) Floppy Disk Drive Connector (34-1 pin FLOPPY)

This connector supports the provided floppy drive ribbon cable. After connecting the single end to the board, connect the two plugs on the other end to the floppy drives. **(Pin 5 is removed to prevent inserting in the wrong orientation when using ribbon cables with pin 5 plugged).**

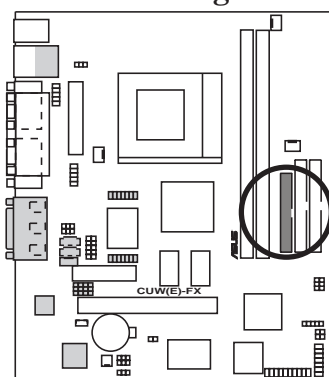

CUW(E)-FX Floppy Disk Drive Connector

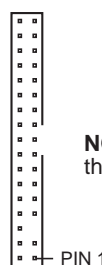

**NOTE:** Orient the red markings on the floppy ribbon cable to PIN 1



# 3. HARDWARE SETUP

## 12) Wake-On-LAN Connector (3-pin WOL\_CON)

This connector connects to a LAN card with a Wake-On-LAN output, such as the ASUS PCI-L101 Ethernet card (not required for onboard LAN model). The connector powers up the system when a wakeup packet or signal is received through the LAN card.

**IMPORTANT:** This feature requires that **Wake On LAN** is set to *Enabled* (see **4.5.1 Power Up Control**) and that your system has an ATX power supply with at least 720mA +5V standby power.

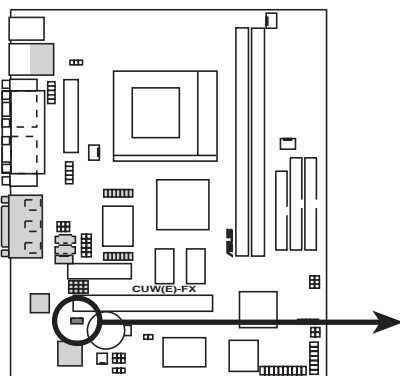

CUW(E)-FX Wake-On-LAN Connector

**IMPORTANT:** Requires an ATX power supply with at least 720mA +5 volt standby power

WOL\_CON

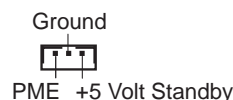

## 13) Wake-On-Ring Connector (2-pin WOR)

This connector connects to internal modem cards with a Wake-On-Ring output. The connector powers up the system when a ringup packet or signal is received through the internal modem card. **NOTE:** For external modems, Wake-On-Ring is detected through the COM port.

**IMPORTANT:** This feature requires that **PWR Up On Modem Act** is set to *Enabled* (see **4.5.1 Power Up Control**) and that your system has an ATX power supply with at least 720mA +5V standby power.

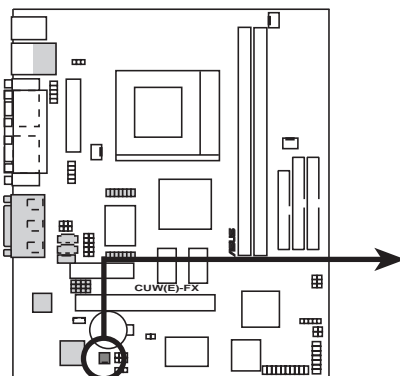

CUW(E)-FX Wake-On-Ring Connector

WOR

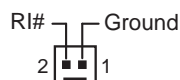

# 3. HARDWARE SETUP

## 14) IDE Activity LED Lead (2-pin IDELED)

This connector supplies power to the cabinet's IDE activity LED. Read and write activity by devices connected to the Primary or Secondary IDE connectors will cause the LED to light up.

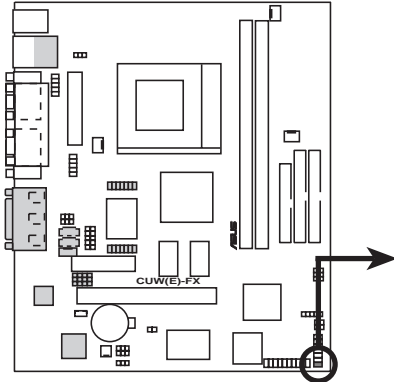

**CUW(E)-FX IDE Activity LED**

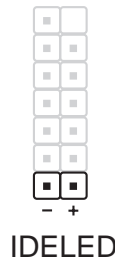

**TIP:** If the case-mounted LED does not light, try reversing the 2-pin plug.

## 15) Chassis, CPU, & Power Supply Fan Connectors (3-pin CHA\_, CPU\_, PWR\_FAN)

These connectors support cooling fans of 350mA (4.2 Watts) or less. Orientate the fans so that the heat sink fins allow airflow to go across the onboard heat sink(s) instead of the expansion slots. Depending on the fan manufacturer, the wiring and plug may be different. The red wire should be positive, while the black should be ground. Connect the fan's plug to the board taking into consideration the polarity of the connector.

**NOTE:** The "Rotation" signal is to be used only by a specially designed fan with rotation signal. The Rotations per Minute (RPM) can be monitored using ASUS PC Probe Utility or Intel LDCM Utility (see section 6. SOFTWARE REFERENCE).

**WARNING!** The CPU and/or motherboard will overheat if there is no airflow across the CPU and onboard heatsinks. Damage may occur to the motherboard and/or the CPU fan if these pins are incorrectly used. **These are not jumpers, do not place jumper caps over these pins.**

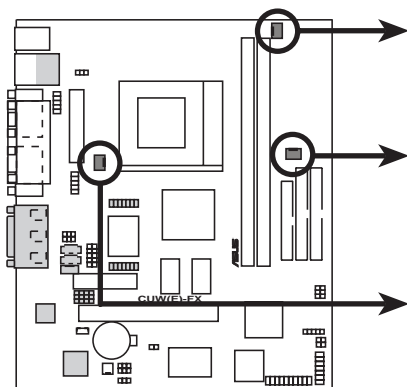

**CUW(E)-FX 12-Volt Cooling Fan Power**

### CPU Fan Power

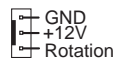

### Chassis Fan Power



### Power Supply Fan Power

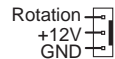

# 3. HARDWARE SETUP

## 16) Serial and Consumer IR Connectors (10-pin IR\_CON)

This connector supports an optional wireless transmitting and receiving infrared module. This module mounts to a small opening on system cases that support this feature. You must also configure the setting through **UART2 Use Infrared** (see **4.4.2 I/O Device Configuration**) to select whether UART2 is directed for use with COM2 or IrDA. Use the five pins as shown in Back View and connect a ribbon cable from the module to the motherboard's SIR connector according to the pin definitions. An optional consumer infrared (CIR) set connects to the CIR and SIR connectors simultaneously for both wireless transmitting and remote control functions through one external infrared module. **Wake On PS2 KB/Mouse** in **4.5.1 Power Up Control** must be Enabled in order to use Consumer Infrared (CIR) power up.

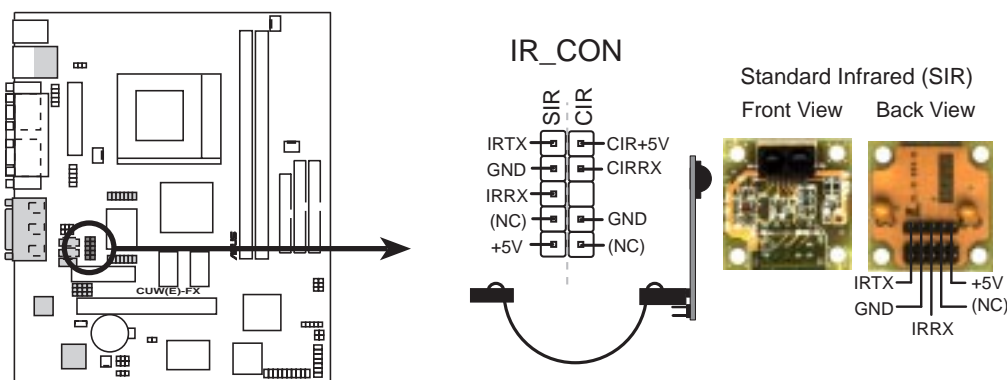

**CUW(E)-FX Infrared Module Connector**

## 17) Serial COM 2 Port Header (10-1 pin COM2)

The optional serial port bracket can be used to add a serial port for additional serial devices.

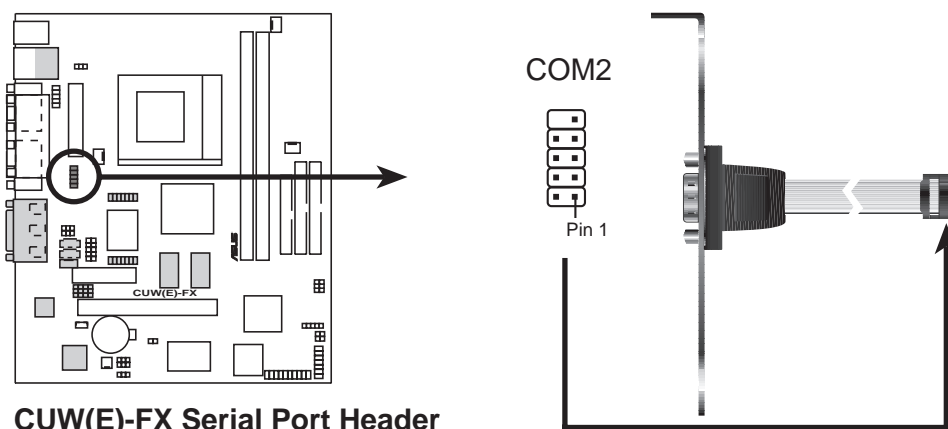

**CUW(E)-FX Serial Port Header**

# 3. HARDWARE SETUP

## 18) SMBus Connector (5-1 pin SMB)

This connector allows you to connect SMBus (System Management Bus) devices. SMBus devices communicate by means of the SMBus with an SMBus host and/or other SMBus devices. SMBus is a specific implementation of an I<sup>2</sup>C bus, which is a multi-device bus; that is, multiple chips can be connected to the same bus and each one can act as a master by initiating data transfer.

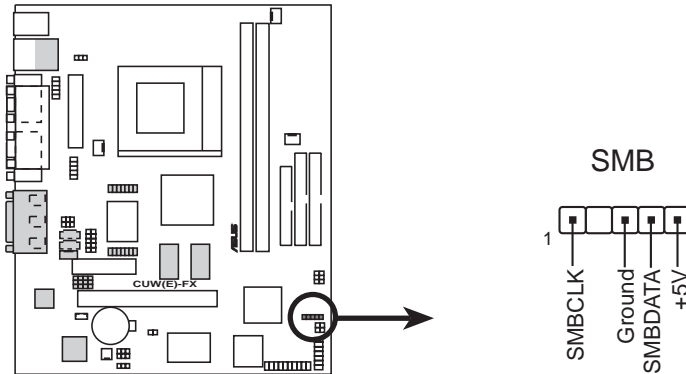

**CUW(E)-FX SMBus Connector**

## 19) LCD-TV Headers (14-pin LCDTV0/LCDTV1) (optional)

These headers require an optional LCD module (see *7.1 ASUS LCD-I Controller Module*) for LCD output or a TV-out module for TV output.

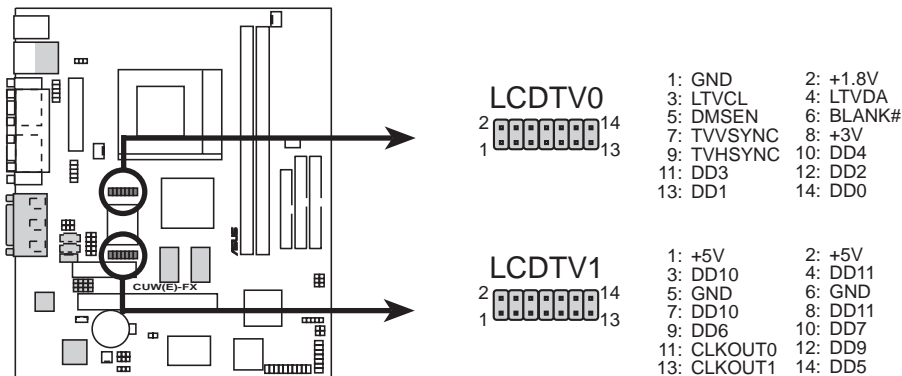

**CUW(E)-FX LCD-TV Headers**

## 20) Internal Microphone Connector (3 pin MIC2)

This connector allows you to connect a chassis mounted microphone to the motherboard instead of having to attach an external microphone onto the ATX connectors.

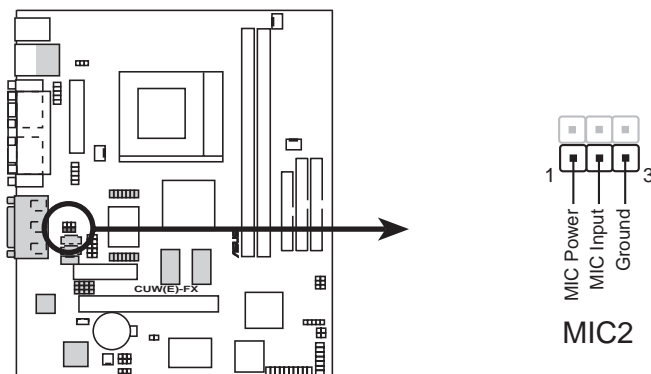

**CUW(E)-FX Internal Microphone Connector**

# 3. HARDWARE SETUP

## 21) Internal Audio Connectors (4-pin VIDEO, CD1, MODEM)

These connectors allow you to receive stereo audio input from such sound sources as a CD-ROM, TV tuner, or MPEG card. The MODEM connector allows the onboard audio to interface with a voice modem card with a similar connector. It also allows the sharing of mono\_in (such as a phone) and mono\_out (such as a speaker) between the onboard audio and the voice modem card

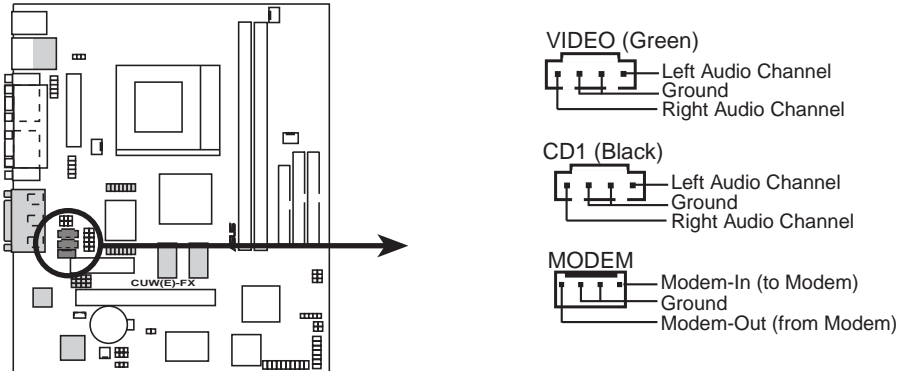

**CUW(E)-FX Internal Audio Connectors**

## 22) Front Panel USB Header (10-1 pin FRONTUSB)

If you do not want to use the USB ports on the back panel, a USB header is available midboard. Connect an external connector set to the 10-1 pin block and mount it to the front panel. **NOTE:** The back and front panel ports cannot be used at the same time.

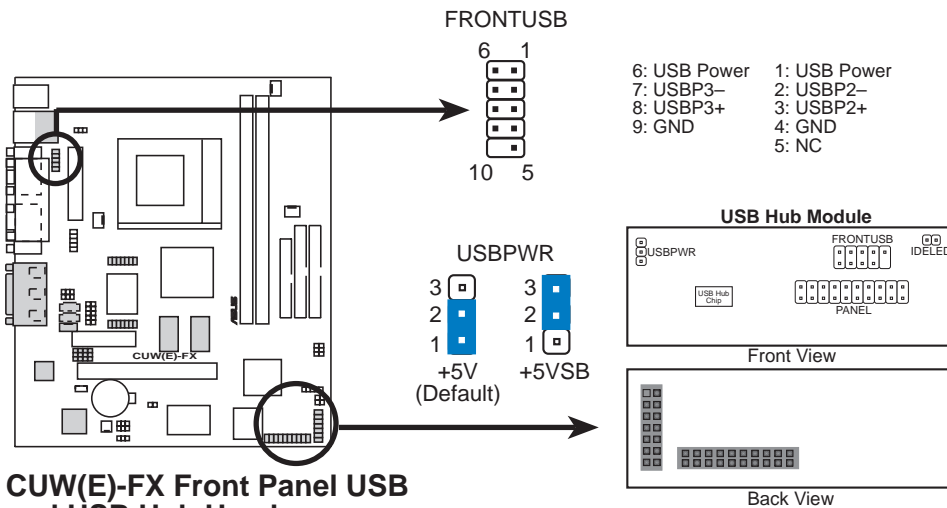

**CUW(E)-FX Front Panel USB and USB Hub Headers**

If you need additional USB ports, an optional USB hub module is available. Remove the jumpers on the VPANEL connector and connect the module directly to the PANEL and VPANEL connectors. You can then connect an external connector set to the USB Hub header and mount it to either the front or back panel for a total of four USB ports.

# 3. HARDWARE SETUP

## 23) Headphone True-Level Line Out Header (3-pin SPKR)

This header allows you to connect a chassis mounted headphone to the motherboard instead of having to attach an external headphone to the ATX connectors.

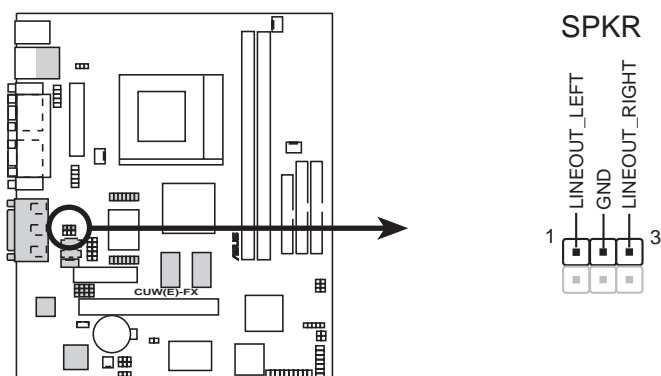

**CUW(E)-FX Internal Speaker Connector**

## 24) Chassis Intrusion Lead (2-pin ACHA)

This lead is for a chassis designed for chassis intrusion detection. After-market toggle switches may also be installed to the chassis panel or on any removable components. Two wires should be available from the chassis to connect to this lead. When any chassis component is removed, the contact should open and the motherboard will record a chassis intrusion event. The event can then be processed by software such as LDCM. If the chassis intrusion lead is not used, a jumper cap must be placed over the pins to close the circuit.

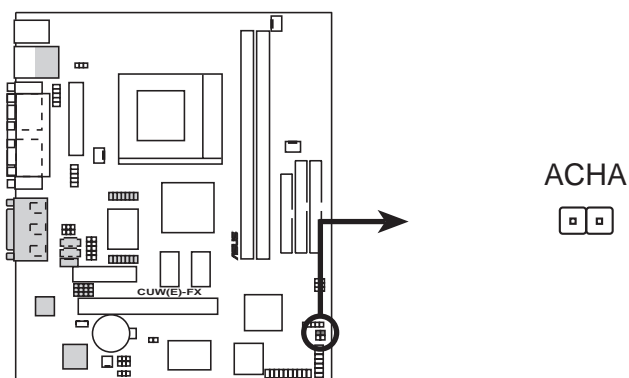

**CUW(E)-FX Chassis Open Alarm Lead**

# 3. HARDWARE SETUP

## 25) ATX Power Supply Connector (20-pin block ATXPWR)

This connector connects to an ATX power supply. The plug from the power supply will only insert in one orientation because of the different hole sizes. Find the proper orientation and push down firmly making sure that the pins are aligned.

**IMPORTANT:** Make sure that your ATX power supply can supply at least 10mA on the +5-volt standby lead (+5VSB). You may experience difficulty in powering ON your system if your power supply cannot support the load. For Wake-On-LAN support, your ATX power supply must supply at least 720mA +5VSB.

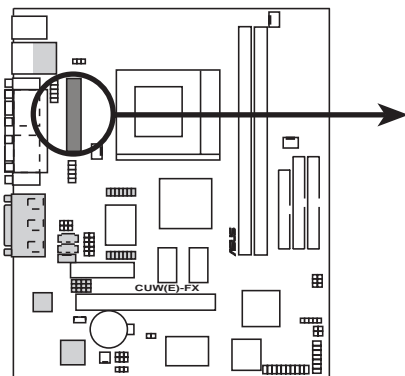

CUW(E)-FX ATX Power Connector

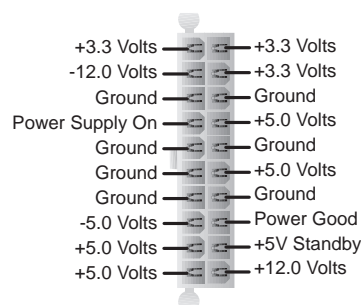

## 26) Power Supply Thermal Sensor Connector (2-pin block JTPWR)

If you have a power supply with thermal monitoring, connect its thermal sensor cable to this connector.

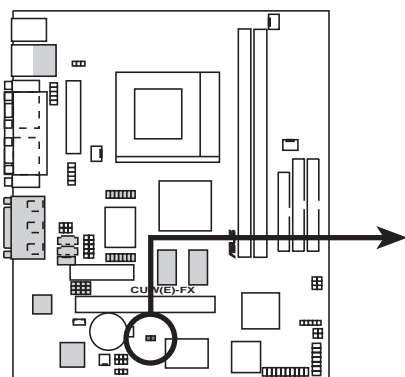

CUW(E)-FX Thermal Sensor Connector

JTPWR



Power Supply Thermal Sensor

# 3. HARDWARE SETUP

## 27) System Power LED Lead (3-1 pin KEYLOCK)

This 3-1 pin connector connects the system power LED, which lights when the system is powered on and blinks when it is in sleep mode.

## 28) Keyboard Lock Switch Lead (2-pin KEYLOCK)

This 2-pin connector connects to the case-mounted key switch to allow keyboard locking.

## 29) System Warning Speaker Connector (4-pin SPEAKER)

This 4-pin connector connects to the case-mounted speaker.

## 30) Reset Switch Lead (2-pin RESET)

This 2-pin connector connects to the case-mounted reset switch for rebooting your computer without having to turn off your power switch. This is a preferred method of rebooting to prolong the life of the system's power supply.

## 31) ATX Power Switch Lead (2-pin PWR)

The system power is controlled by a momentary switch connected to this lead. Pressing the button once will switch the system between ON and SOFT OFF. Pushing the switch while in the ON mode for more than 4 seconds will turn the system off. The system power LED shows the status of the system's power.

## 32) System Management Interrupt Lead (2-pin SMI)

This allows the user to manually place the system into a suspend mode or "Green" mode, where system activity is decreased to save electricity and expand the life of certain components when the system is not in use. This 2-pin connector connects to the case-mounted suspend switch. Wake-up can be controlled by settings in the BIOS but the keyboard will always allow wake-up (the SMI lead cannot wake up the system).

## 33) Message LED Lead (2-pin LED)

This indicates whether a message has been received from a fax/modem. The LED will remain lit when there is no signal and blink when there is data transfer or waiting in the inbox. This function requires ACPI OS and driver support.

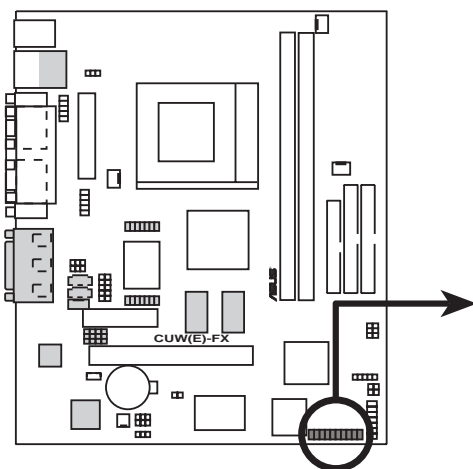

**CUW(E)-FX System Panel Connectors**

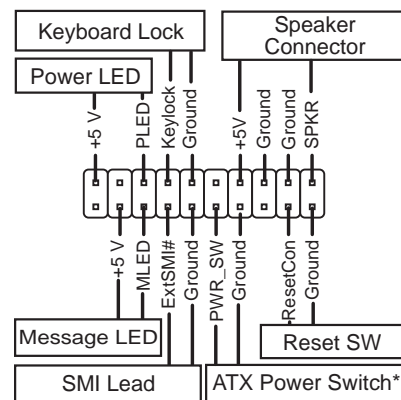

\* Requires an ATX power supply.



# 3. HARDWARE SETUP

---

## 3.9 Starting Up the First Time

1. After all connections are made, close the system case cover.
2. Be sure that all switches are off (in some systems, marked with ○).
3. Connect the power supply cord into the power supply located on the back of your system case according to your system user's manual.
4. Connect the power cord into a power outlet that is equipped with a surge protector.
5. You may then turn on your devices in the following order:
  - a. Your monitor
  - b. External SCSI devices (starting with the last device on the chain)
  - c. Your system power. For ATX power supplies, you need to switch on the power supply as well as press the ATX power switch on the front of the case.
6. The power LED on the front panel of the system case will light. For ATX power supplies, the system LED will light when the ATX power switch is pressed. The LED on the monitor may light up or switch between orange and green after the system's if it complies with "green" standards or if it has a power standby feature. The system will then run power-on tests. While the tests are running, the BIOS will alarm beeps or additional messages will appear on the screen. If you do not see anything within 30 seconds from the time you turn on the power, the system may have failed a power-on test. Recheck your jumper settings and connections or call your retailer for assistance.

### Award BIOS Beep Codes

| Beep                                        | Meaning                                               |
|---------------------------------------------|-------------------------------------------------------|
| One short beep when displaying logo         | No error during POST                                  |
| Long beeps in an endless loop               | No DRAM installed or detected                         |
| One long beep followed by three short beeps | Video card not found or video card memory bad         |
| High frequency beeps when system is working | CPU overheated<br>System running at a lower frequency |

## 3. HARDWARE SETUP

---

7. During power-on, hold down <Delete> to enter BIOS setup. Follow the instructions in **4. BIOS SETUP**.

- \* **Powering Off your computer:** You must first exit or shut down your operating system before switching off the power switch. For ATX power supplies, you can press the ATX power switch after exiting or shutting down your operating system. If you use Windows 9X, click the **Start** button, click **Shut Down**, and then click **Shut down the computer?** The power supply should turn off after Windows shuts down.

**NOTE:** The message “You can now safely turn off your computer” will not appear when shutting down with ATX power supplies.

# 4. BIOS SETUP

## 4.1 Managing and Updating Your BIOS

### 4.1.1 Upon First Use of the Computer System

It is recommended that you save a copy of the original motherboard BIOS along with a Flash Memory Writer utility (AFLASH.EXE) to a bootable floppy disk in case you need to reinstall the BIOS later. **AFLASH.EXE** is a Flash Memory Writer utility that updates the BIOS by uploading a new BIOS file to the programmable flash ROM on the motherboard. This file works only in DOS mode. To determine the BIOS version of your motherboard, check the last four numbers of the code displayed on the upper left-hand corner of your screen during bootup. Larger numbers represent a newer BIOS file.

1. Type **FORMAT A:/S** at the DOS prompt to create a bootable system floppy disk. **DO NOT** copy AUTOEXEC.BAT & CONFIG.SYS to the disk.
2. Type **COPY D:\AFLASH\AFLASH.EXE A:** (assuming D is your CD-ROM drive) to copy AFLASH.EXE to the just created boot disk.

**NOTE:** AFLASH works only in DOS mode. It will not work with DOS prompt in Windows and will not work with certain memory drivers that may be loaded when you boot from your hard drive. It is recommended that you reboot using a floppy.

3. Reboot your computer from the floppy disk. **NOTE:** BIOS setup must specify “Floppy” as the first item in the boot sequence.
4. In DOS mode, type **A:\AFLASH <Enter>** to run AFLASH.

```
ASUS ACPI BIOS
FLASH MEMORY WRITER V1.2B
Copyright (C) 1994-99, ASUSTeK COMPUTER INC.

Flash Memory: Winbond W29C02B or SST 29C02B or Intel H28C20B

Current BIOS Version: ASUS XXX-XX ACPI BIOS Revision 1BDC
BIOS Model          : XXX-XX
BIOS Built Date     : 09/25/98

Choose one of the following:

1. Save Current BIOS To File
2. Update BIOS Including Boot Block and ESCD

Enter choice: [1]

Press ESC To Exit
```

**IMPORTANT!** If “unknown” is displayed after **Flash Memory:**, the memory chip is either not programmable or is not supported by the ACPI BIOS and therefore, cannot be programmed by the Flash Memory Writer utility.

# 4. BIOS SETUP

5. Select **1. Save Current BIOS to File** from the Main menu and press <Enter>. The **Save Current BIOS To File** screen appears.

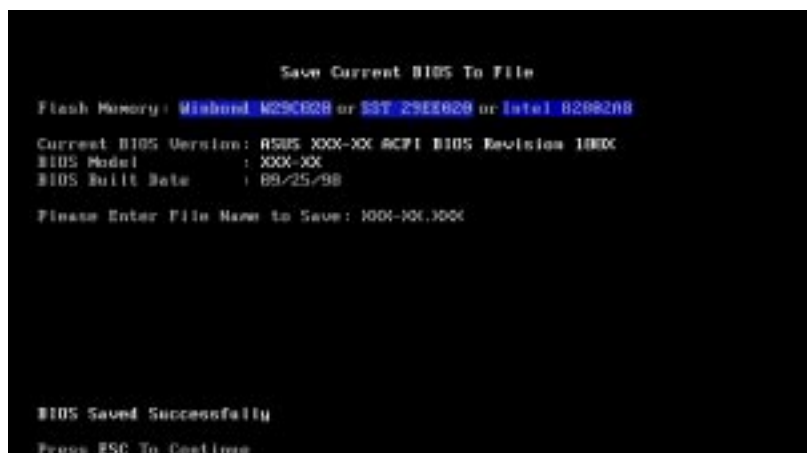

6. Type a filename and the path, for example, **A:\XXX-XX.XXX** and then press <Enter>.

## 4.1.2 Updating BIOS Procedures

**WARNING!** Only update your BIOS if you have problems with your motherboard and you know that the new BIOS revision will solve your problems. Careless updating can result in your motherboard having more problems!

1. Download an updated ASUS BIOS file from the Internet (WWW or FTP) (see **ASUS CONTACT INFORMATION** on page 3 for details) and save to the disk you created earlier.
2. Boot from the disk you created earlier.
3. At the “A:\” prompt, type **AFLASH** and then press <Enter>.
4. At the **Main Menu**, type **2** and then press <Enter>. The **Update BIOS Including Boot Block and ESCD** screen appears.
5. Type the filename of your new BIOS and the path, for example, **A:\XXX-XX.XXX**, and then press <Enter>.

**NOTE:** To cancel this operation, press <Enter>.



# 4. BIOS SETUP

6. When prompted to confirm the BIOS update, press **Y** to start the update.

```
Update BIOS Including Boot Block and ESCD
Flash Memory: Winbond W25Q008 or SST 25CF008 or Intel B25R248

BIOS Version
(CURRENT) ASUS 300-XX ACPI BIOS Revision 180X
(Next)and1 ASUS 300-XX ACPI BIOS Revision 180X

BIOS Model
(CURRENT) 300-XX
(Next)and1 300-XX

Date of BIOS Build
(CURRENT) 05/25/08
(DX000_1000) 05/25/08

Notice: Boot Block is different. Check sum of 1001.010 is F25E.
Are you sure (Y/N) ? [Y]

Press ESC To Return to Main Menu
```

7. The utility starts to program the new BIOS information into the flash ROM. The boot block will be updated automatically only when necessary. This will minimize the chance that a failed update will prevent your system from booting up. When the programming is finished, *Flashed Successfully* will be displayed.

```
Update BIOS Including Boot Block and ESCD
Flash Memory: Winbond W25Q008 or SST 25CF008 or Intel B25R248

BIOS Version
(CURRENT) ASUS 300-XX ACPI BIOS Revision 180X
(Next)and1 ASUS 300-XX ACPI BIOS Revision 180X

BIOS Model
(CURRENT) 300-XX
(Next)and1 300-XX

Date of BIOS Build
(CURRENT) 05/25/08
(DX000_1000) 05/25/08

Notice: Boot Block is different. Check sum of 1001.010 is F25E.
Are you sure (Y/N) ? [Y]
Block Erasing -- Done
Programming -- 3FFFF
Flashed Successfully

Press ESC To Continue
```

8. Follow the onscreen instructions to continue.

```
ASUS ACPI BIOS
FLASH MEMORY WRITER V0.20
Copyright (C) 1994-09, ASUSTeK COMPUTER INC.

Flash Memory: Winbond W25Q008 or SST 25CF008 or Intel B25R248

Current BIOS Version: ASUS 300-XX ACPI BIOS Revision 180X
BIOS Model : 300-XX
BIOS Build Date : 05/25/08

Choose one of the following:
1. Save Current BIOS To File
2. Update BIOS Including Boot Block and ESCD

Enter choice: 113

You have flashed the EPROM. It is recommended that you turn off
the power, enter SETUP and Load Setup Defaults to have CMOS
updated with new BIOS when exits.

Press ESC To Exit
```

**WARNING!** If you encounter problems while updating the new BIOS, DO NOT turn off your system since this might prevent your system from booting up. Just repeat the process, and if the problem still persists, update the original BIOS file you saved to disk above. If the Flash Memory Writer utility was not able to successfully update a complete BIOS file, your system may not be able to boot up. If this happens, your system will need servicing.

# 4. BIOS SETUP

---

## 4.2 BIOS Setup Program

This motherboard supports a programmable EEPROM that can be updated using the provided utility as described in *4.1 Managing and Updating Your BIOS*.

The utility is used if you are installing a motherboard, reconfiguring your system, or prompted to “**Run Setup**”. This section describes how to configure your system using this utility.

Even if you are not prompted to use the Setup program, at some time in the future you may want to change the configuration of your computer. For example, you may want to enable the Security Password Feature or make changes to the power management settings. It will then be necessary to reconfigure your system using the BIOS Setup program so that the computer can recognize these changes and record them in the CMOS RAM of the EEPROM.

The EEPROM on the motherboard stores the Setup utility. When you start up the computer, the system provides you with the opportunity to run this program. This appears during the Power-On Self Test (POST). Press <Delete> to call up the Setup utility. If you are a little bit late in pressing the mentioned key, POST will continue with its test routines, thus preventing you from calling up Setup. If you still need to call Setup, restart the system by pressing <Ctrl> + <Alt> + <Delete>, or by pressing the Reset button on the system chassis. You can also restart by turning the system off and then back on again. But do so only if the first two methods fail.

The Setup program has been designed to make it as easy to use as possible. It is a menu-driven program, which means you can scroll through the various sub-menus and make your selections among the predetermined choices.

**To access the BIOS Setup program, press the <Delete> key after the computer has run through its POST.**

**NOTE:** Because the BIOS software is constantly being updated, the following BIOS screens and descriptions are for reference purposes only and may not reflect your BIOS screens exactly.

# 4. BIOS SETUP

## 4.2.1 BIOS Menu Bar

The top of the screen has a menu bar with the following selections:

- MAIN** Use this menu to make changes to the basic system configuration.
- ADVANCED** Use this menu to enable and make changes to the advanced features.
- POWER** Use this menu to configure and enable Power Management features.
- BOOT** Use this menu to configure the default system device used to locate and load the Operating System.
- EXIT** Use this menu to exit the current menu or specify how to exit the Setup program.

To access the menu bar items, press the right or left arrow key on the keyboard until the desired item is highlighted.

## 4.2.2 Legend Bar

At the bottom of the Setup screen you will notice a legend bar. The keys in the legend bar allow you to navigate through the various setup menus. The following table lists the keys found in the legend bar with their corresponding alternates and functions.

| Navigation Key(s)        | Function Description                                               |
|--------------------------|--------------------------------------------------------------------|
| <F1> or <Alt + H>        | Displays the General Help screen from anywhere in the BIOS Setup   |
| <Esc>                    | Jumps to the Exit menu or returns to the main menu from a sub-menu |
| ← or → (keypad arrow)    | Selects the menu item to the left or right                         |
| ↑ or ↓ (keypad arrow)    | Moves the highlight up or down between fields                      |
| - (minus key)            | Scrolls backward through the values for the highlighted field      |
| + (plus key) or spacebar | Scrolls forward through the values for the highlighted field       |
| <Enter>                  | Brings up a selection menu for the highlighted field               |
| <Home> or <PgUp>         | Moves the cursor to the first field                                |
| <End> or <PgDn>          | Moves the cursor to the last field                                 |
| <F5>                     | Resets the current screen to its Setup Defaults                    |
| <F10>                    | Saves changes and exits Setup                                      |

# 4. BIOS SETUP

## General Help

In addition to the Item Specific Help window, the BIOS setup program also provides a General Help screen. This screen can be called up from any menu by simply pressing <F1> or the <Alt> + <H> combination. The General Help screen lists the legend keys with their corresponding alternates and functions.

## Saving Changes and Exiting the Setup Program

See *4.7 Exit Menu* for detailed information on saving changes and exiting the setup program.

## Scroll Bar

When a scroll bar appears to the right of a help window, it indicates that there is more information to be displayed that will not fit in the window. Use <PgUp> and <PgDn> or the up and down arrow keys to scroll through the entire help document. Press <Home> to display the first page, press <End> to go to the last page. To exit the help window, press <Enter> or <Esc>.

## Sub-Menu

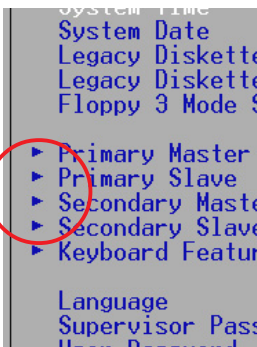

Note that a right pointer symbol (as shown in the left view) appears to the left of certain fields. This pointer indicates that a sub-menu can be launched from this field. A sub-menu contains additional options for a field parameter. To call up a sub-menu, simply move the highlight to the field and press <Enter>. The sub-menu will then immediately appear. Use the legend keys to enter values and move from field to field within a sub-menu just as you would within a menu. Use the <Esc> key to return to the main menu.

Take some time to familiarize yourself with each of the legend keys and their corresponding functions. Practice navigating through the various menus and sub-menus. If you accidentally make unwanted changes to any of the fields, use the set default hot key <F5>. While moving around through the Setup program, note that explanations appear in the Item Specific Help window located to the right of each menu. This window displays the help text for the currently highlighted field.

**NOTE:** The item heading in square brackets represents the default setting for that field.



# 4. BIOS SETUP

## 4.3 Main Menu

When the Setup program is accessed, the following screen appears:

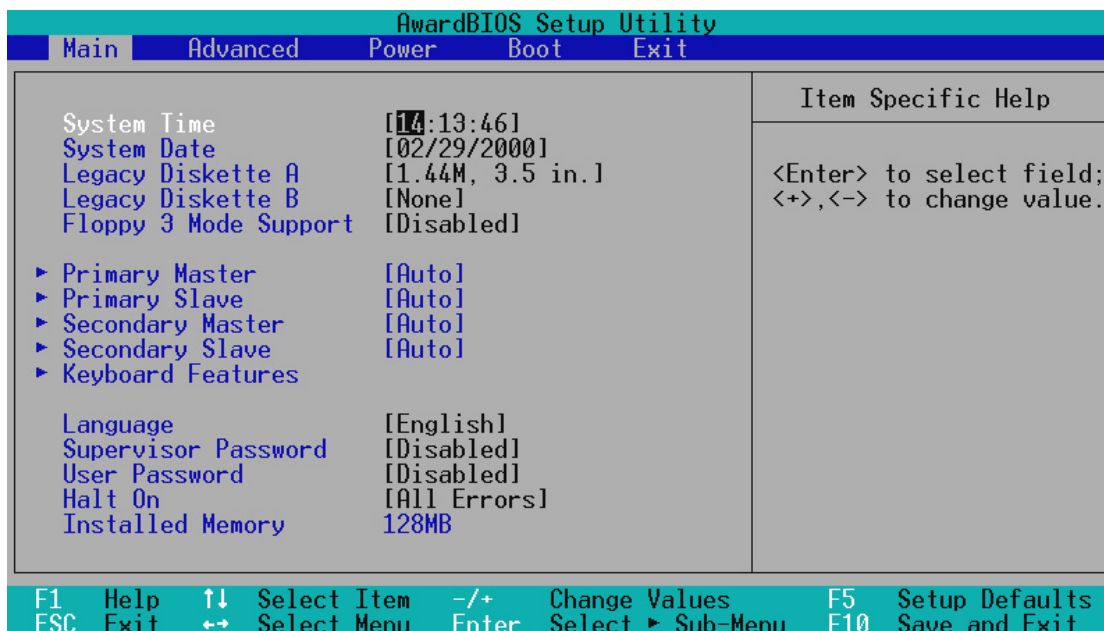

### System Time [XX:XX:XX]

Sets your system to the time that you specify (usually the current time). The format is hour, minute, second. Valid values for hour, minute and second are **Hour: (00 to 23)**, **Minute: (00 to 59)**, **Second: (00 to 59)**. Use the <Tab> or <Shift> + <Tab> keys to move between the hour, minute, and second fields.

### System Date [XX/XX/XXXX]

Sets your system to the date that you specify (usually the current date). The format is month, day, year. Valid values for month, day, and year are **Month: (1 to 12)**, **Day: (1 to 31)**, **Year: (100 year range)**. Use the <Tab> or <Shift> + <Tab> keys to move between the month, day, and year fields.

### Legacy Diskette A [1.44M, 3.5 in.], Legacy Diskette B [None]

Sets the type of floppy drives installed. Configuration options: [None] [360K, 5.25 in.] [1.2M , 5.25 in.] [720K , 3.5 in.] [1.44M, 3.5 in.] [2.88M, 3.5 in.]

### Floppy 3 Mode Support [Disabled]

This is required to support older Japanese floppy drives. Floppy 3 Mode support will allow reading and writing of 1.2MB (as opposed to 1.44MB) on a 3.5-inch diskette. Configuration options: [Disabled] [Drive A] [Drive B] [Both]

# 4. BIOS SETUP

## 4.3.1 Primary & Secondary Master/Slave

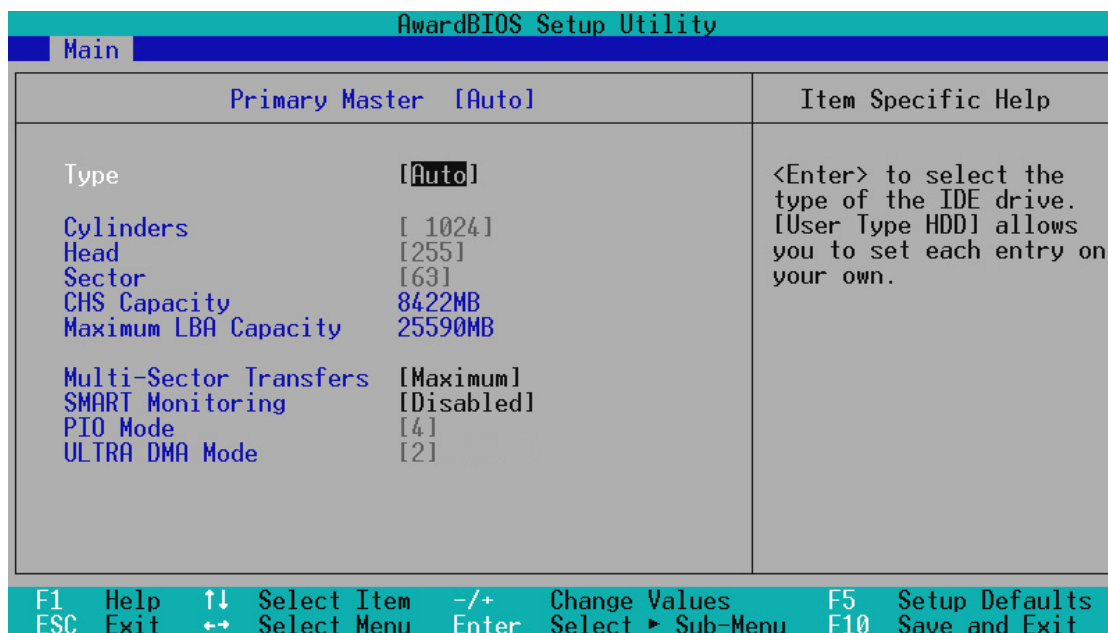

**NOTE:** Before attempting to configure a hard disk drive, make sure you have the configuration information supplied by the manufacturer of the drive. Incorrect settings may cause your system to not recognize the installed hard disk. To allow the BIOS to detect the drive type automatically, select [Auto].

### Type [Auto]

Select [Auto] to automatically detect an IDE hard disk drive. If automatic detection is successful, the correct values will be filled in for the remaining fields on this sub-menu. If automatic detection fails, your hard disk drive may be too old or too new. You can try updating your BIOS or enter the IDE hard disk drive parameters manually.

**NOTE:** After the IDE hard disk drive information has been entered into BIOS, new IDE hard disk drives must be partitioned (such as with FDISK) and then formatted before data can be read from and write on. Primary IDE hard disk drives must have its partition set to *active* (also possible with FDISK).

Other options for the **Type** field are:

-----  
**[None] - to disable IDE devices**

# 4. BIOS SETUP

**IMPORTANT:** If your hard disk was already formatted on an older previous system, incorrect parameters may be detected. You will need to enter the correct parameters manually or use low-level format if you do not need the data stored on the hard disk. If the parameters listed differ from the ones used when the disk was formatted, the disk will not be readable. If the auto-detected parameters do not match the ones that should be used for your disk, you should enter the correct ones manually by setting [User Type HDD].

## [User Type HDD]

| AwardBIOS Setup Utility                                                      |                 |                                                                                                        |  |
|------------------------------------------------------------------------------|-----------------|--------------------------------------------------------------------------------------------------------|--|
| Main                                                                         |                 |                                                                                                        |  |
| Primary Master                                                               | [User Type HDD] | Item Specific Help                                                                                     |  |
| Type                                                                         | [User Type HDD] | <Enter> to select the type of the IDE drive. [User Type HDD] allows you to set each entry on your own. |  |
| Translation Method                                                           | [LBA]           |                                                                                                        |  |
| Cylinders                                                                    | [ 1024]         |                                                                                                        |  |
| Head                                                                         | [255]           |                                                                                                        |  |
| Sector                                                                       | [63]            |                                                                                                        |  |
| CHS Capacity                                                                 | 8422MB          |                                                                                                        |  |
| Maximum LBA Capacity                                                         | 25590MB         |                                                                                                        |  |
| Multi-Sector Transfers                                                       | [Maximum]       |                                                                                                        |  |
| SMART Monitoring                                                             | [Disabled]      |                                                                                                        |  |
| PIO Mode                                                                     | [4]             |                                                                                                        |  |
| ULTRA DMA Mode                                                               | [2]             |                                                                                                        |  |
| F1 Help    ↑↓ Select Item    -/+ Change Values    F5 Setup Defaults          |                 |                                                                                                        |  |
| ESC Exit    ↔ Select Menu    Enter Select    ▶ Sub-Menu    F10 Save and Exit |                 |                                                                                                        |  |

Manually enter the number of cylinders, heads and sectors per track for your drive. Refer to your drive documentation or look on the drive for this information. If no drive is installed or if you are removing a drive and not replacing it, select [None].

### Translation Method [LBA]

Select the hard disk drive type in this field. When Logical Block Addressing is enabled, 28-bit addressing of the hard drive is used without regard for cylinders, heads, or sectors. Note that LBA Mode is necessary for drives with greater than 504MB in storage capacity. Configuration options: [LBA] [LARGE] [Normal] [Match Partition Table] [Manual]

### Cylinders

This field configures the number of cylinders. Refer to your drive documentation to determine the correct value to enter into this field. **NOTE:** To make changes to this field, the **Type** field must be set to [User Type HDD] and the **Translation Method** field must be set to [Manual].

# 4. BIOS SETUP

---

## Head

This field configures the number of read/write heads. Refer to your drive documentation to determine the correct value to enter into this field. **NOTE:** To make changes to this field, the **Type** field must be set to [User Type HDD] and the **Translation Method** field must be set to [Manual].

## Sector

This field configures the number of sectors per track. Refer to your drive documentation to determine the correct value to enter into this field. **NOTE:** To make changes to this field, the **Type** field must be set to [User Type HDD] and the **Translation Method** field must be set to [Manual].

## CHS Capacity

This field shows the drive's maximum CHS capacity calculated automatically by the BIOS from the drive information you entered.

## Maximum LBA Capacity

This field shows the drive's maximum LBA capacity calculated automatically by the BIOS from the drive information you entered.

## Multi-Sector Transfers [Maximum]

This option automatically sets the number of sectors per block to the highest number supported by the drive. This field can also be configured manually. Note that when this field is automatically configured, the set value may not always be the fastest value for the drive. Refer to the documentation that came with your hard drive to determine the optimal value and set it manually. **NOTE:** To make changes to this field, the **Type** field must be set to [User Type HDD]. Configuration options: [Disabled] [2 Sectors] [4 Sectors] [8 Sectors] [16 Sectors] [32 Sectors] [Maximum]

## SMART Monitoring [Disabled]

This allows the enabling or disabling of the S.M.A.R.T. (Self-Monitoring, Analysis and Reporting Technology) system which utilizes internal hard disk drive monitoring technology. This feature is normally disabled because system resources used in this feature may decrease system performance. Configuration options: [Disabled] [Enabled]

## PIO Mode [4]

This option lets you set a PIO (Programmed Input/Output) mode for the IDE device. Modes 0 through 4 provide successively increased performance. Configuration options: [0] [1] [2] [3] [4]

## Ultra DMA Mode [Disabled]

Ultra DMA capability allows improved transfer speeds and data integrity for compatible IDE devices. Set to [Disabled] to suppress Ultra DMA capability. **NOTE:** To make changes to this field, the **Type** field must be set to [User Type HDD]. Configuration options: [0] [1] [2] [3] [4] [Disabled]

## 4. BIOS SETUP

---

Other options for “Type:” are:

**[CD-ROM]** - for IDE CD-ROM drives

**[LS-120]** - for LS-120 compatible floppy disk drives

**[ZIP-100]** - for ZIP-100 compatible disk drives

**[MO]** - for IDE magneto optical disk drives

**[Other ATAPI Device]** - for IDE devices not listed here

After using the legend keys to make your selections on this sub-menu, press the <Esc> key to exit back to the Main menu. When the Main menu appears, you will notice that the drive size appear in the field for the hard disk drive that you just configured.

---

# 4. BIOS SETUP

## 4.3.2 Keyboard Features

| AwardBIOS Setup Utility                                                                                   |                                   |
|-----------------------------------------------------------------------------------------------------------|-----------------------------------|
| Main                                                                                                      |                                   |
| Keyboard Features                                                                                         | Item Specific Help                |
| Boot Up NumLock Status [On]<br>Keyboard Auto-Repeat Rate [30/Sec]<br>Keyboard Auto-Repeat Delay [1/2 Sec] | Select Power-on state for Numlock |

F1 Help ↑↓ Select Item -/+ Change Values F5 Setup Defaults  
ESC Exit ↔ Select Menu Enter Select ► Sub-Menu F10 Save and Exit

### Boot Up NumLock Status [On]

This field controls the state of the NumLock key when the system boots. When switched on, the numeric keypad generates numbers instead of controlling cursor operations. Configuration options: [Off] [On]

### Keyboard Auto-Repeat Rate [30/Sec]

This field controls the speed at which the system registers repeated keystrokes. Configuration options: [6/Sec] [8/Sec] [10/Sec] [12/Sec] [15/Sec] [20/Sec] [24/Sec] [30/Sec]

### Keyboard Auto-Repeat Delay [1/2 Sec]

This field sets the delay before keystrokes begin to repeat. Configuration options: [1/4 Sec] [1/2 Sec] [3/4 Sec] [1 Sec]

-----

# 4. BIOS SETUP

---

## **Language [English]**

This allows selection of the BIOS' displayed language. Currently only English is available.

## **Supervisor Password [Disabled], User Password [Disabled]**

These fields allow you to set the system passwords. To set any of the passwords, select the appropriate field and press <Enter>.

Type in a password and press <Enter>. You can type up to eight alphanumeric characters. Symbols and other keys are ignored. To confirm the password, type the password again and press <Enter>. The password is now set to [Enabled]. When [Enabled], a Supervisor password is required to access the BIOS setup utility and all important menu options while a User password is required to access the computer system.

To clear either password, select the appropriate field and press <Enter>. Press <Enter> again when a dialog box appears. This sets the password field to [Disabled].

### **A Note about Passwords**

The passwords are not case sensitive. In other words, it makes no difference whether you enter a password using upper- or lowercase letters.

The BIOS Setup program allows you to specify two separate passwords: a Supervisor password and a User password. When both of them are disabled, anyone may access all BIOS Setup program functions.

## **Halt On [All Errors]**

This field determines which types of errors will cause the system to halt. Configuration options: [All Errors] [No Error] [All but Keyboard] [All but Disk] [All but Disk/Keyboard]

## **Installed Memory [XXX MB]**

This field displays the amount of conventional memory detected by the system during bootup. You do not need to make changes to this field. This is a display only field.

# 4. BIOS SETUP

## 4.4 Advanced Menu

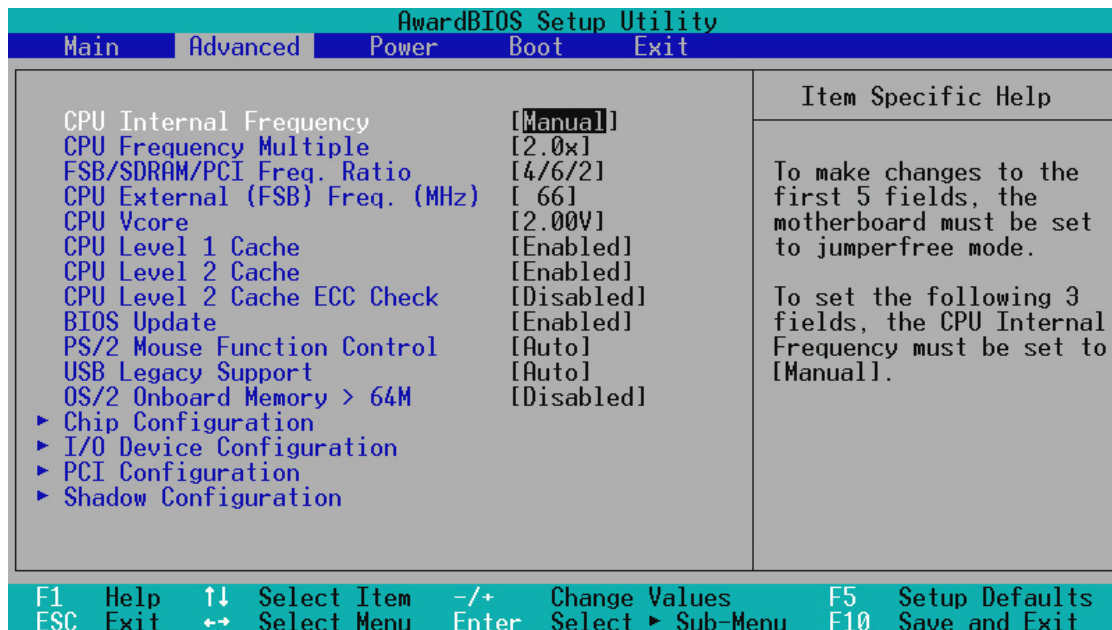

### CPU Internal Frequency [Manual]

When the motherboard is set to JumperFree™ mode, this field allows you to select the internal frequency of your CPU. Select [Manual] if you want to make changes to the subsequent 3 fields.

### CPU Frequency Multiple (when CPU Speed is set to [Manual])

This field is for unlocked processors only. If your socket 370 processor's Frequency Multiple is detected locked, you will not be able to access this field. This field sets the frequency multiple between the CPU's *internal* frequency and *external* frequency. This must be set in conjunction with **CPU External (FSB) Frequency** to match the speed of your CPU. Configuration options: [2.0x] [2.5x] [3.0x]...[7.0x] [7.5x] [8.0x]

### FSB/SDRAM/PCI Freq. Ratio (when CPU Speed is set to [Manual])

This feature tells the clock generator what frequencies to send to the local bus and PCI devices onboard. The bus frequency (**external frequency**) multiplied by the bus multiple equals the CPU's internal frequency.

### CPU External (FSB) Frequency (MHz) (when CPU Speed is set to [Manual])

This feature tells the clock generator what frequency to send to the CPU, DRAM, and chipset. The bus frequency (**external frequency**) multiplied by the bus multiple equals the CPU's internal frequency (the **CPU speed**). The configuration options vary depending on the **CPU/SDRAM/PCI Frequency Ratio**.



## 4. BIOS SETUP

---

### **CPU Vcore**

This field displays the core voltage supplied to the CPU. If you want to set it manually, always refer to the CPU documentation.

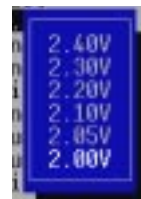

### **CPU Level 1 Cache, CPU Level 2 Cache [Enabled]**

These fields allow you to choose from the default of [Enabled] or choose [Disabled] to turn on or off the CPU's Level 1 and Level 2 built-in cache. Configuration options: [Disabled] [Enabled]

### **CPU Level 2 Cache ECC Check [Disabled]**

This function controls the ECC capability in the CPU level 2 cache. Configuration options: [Disabled] [Enabled]

### **BIOS Update [Enabled]**

This functions as an update loader integrated into the BIOS to supply the processor with the required data. In the default position of [Enabled], the BIOS will load the update on all processors during system bootup. Configuration options: [Disabled] [Enabled]

### **PS/2 Mouse Function Control [Auto]**

The default of [Auto] allows the system to detect a PS/2 mouse on startup. If detected, IRQ12 will be used for the PS/2 mouse. IRQ12 will be reserved for expansion cards only if a PS/2 mouse is not detected. [Enabled] will always reserve IRQ12, whether on startup a PS/2 mouse is detected or not. Configuration options: [Enabled] [Auto]

### **USB Legacy Support [Auto]**

This motherboard supports Universal Serial Bus (USB) devices. The default of [Auto] allows the system to detect a USB device on startup. If detected, the USB controller will be enabled. If not detected, the USB controller will be disabled. When this field is set to [Disabled], the USB controller is disabled no matter whether you are using a USB device or not. Configuration options: [Disabled] [Enabled] [Auto]

### **OS/2 Onboard Memory > 64M [Disabled]**

When using OS/2 operating systems with installed DRAM of greater than 64MB, you need to set this option to [Enabled]; otherwise, leave this on [Disabled]. Configuration options: [Disabled] [Enabled]

# 4. BIOS SETUP

## Notes for JumperFree Mode

### CPU Upgrade/Reinstallation

To ensure that your system can enter BIOS setup after the processor has been changed or reinstalled, your system will start up running at a bus speed of 66MHz and a fail-safe CPU internal frequency (4x66MHz for the Intel Coppermine processor or 2x66MHz for non-Coppermine processors). It will then automatically take you to the Advanced menu with a popup menu of all the officially possible CPU speeds.

| AwardBIOS Setup Utility                                                                                                                                                                                                                                                                                                                                                                                                                             |          |       |      |      |                                                                                                                                                                                                                                                                                                                                                   |
|-----------------------------------------------------------------------------------------------------------------------------------------------------------------------------------------------------------------------------------------------------------------------------------------------------------------------------------------------------------------------------------------------------------------------------------------------------|----------|-------|------|------|---------------------------------------------------------------------------------------------------------------------------------------------------------------------------------------------------------------------------------------------------------------------------------------------------------------------------------------------------|
| Main                                                                                                                                                                                                                                                                                                                                                                                                                                                | Advanced | Power | Boot | Exit |                                                                                                                                                                                                                                                                                                                                                   |
| CPU Internal Frequency [Manual]<br>CPU Frequency Multiple [7.0x]<br>FSB/SDRAM/PCI Freq. Ratio [8/6/2]<br>CPU External (FSB) Freq. (MHz) [133]<br>CPU Vcore [2.00V]<br>CPU Level 1 Cache<br>CPU Level 2 Cache<br>CPU Level 2 Cache ECC Check<br>BIOS Update<br>PS/2 Mouse Function Control<br>USB Legacy Support<br>OS/2 Onboard Memory > 64M<br>▶ Chip Configuration<br>▶ I/O Device Configuration<br>▶ PCI Configuration<br>▶ Shadow Configuration |          |       |      |      | Item Specific Help<br><br>Since you use a new CPU or reinstall your CPU, the system boots up in safe mode to make sure the system can enter setup menu. Now, you can adjust the CPU internal frequency as you wish. If the frequency is adjusted too high, the system may hang. Please turn off the system and then restart to set the frequency. |
| F1 Help ↑↓ Select Item -/+ Change Values F5 Setup Defaults<br>ESC Exit ↔ Select Menu Enter Select ▶ Sub-Menu F10 Save and Exit                                                                                                                                                                                                                                                                                                                      |          |       |      |      |                                                                                                                                                                                                                                                                                                                                                   |

### For processors with locked frequency multiplier

| AwardBIOS Setup Utility                                                                                                                                                                                                                                                                                                                                                                                                                                                                                                       |          |       |      |      |                                                                                                                                                                                                                                                                                                                                                                             |
|-------------------------------------------------------------------------------------------------------------------------------------------------------------------------------------------------------------------------------------------------------------------------------------------------------------------------------------------------------------------------------------------------------------------------------------------------------------------------------------------------------------------------------|----------|-------|------|------|-----------------------------------------------------------------------------------------------------------------------------------------------------------------------------------------------------------------------------------------------------------------------------------------------------------------------------------------------------------------------------|
| Main                                                                                                                                                                                                                                                                                                                                                                                                                                                                                                                          | Advanced | Power | Boot | Exit |                                                                                                                                                                                                                                                                                                                                                                             |
| CPU Internal Frequency Manual<br>CPU Frequency Multiple 300MHz<br>FSB/SDRAM/PCI Freq. Ratio 350MHz<br>CPU External (FSB) Freq. (MHz) 400MHz<br>CPU Vcore 450MHz<br>CPU Level 1 Cache 500MHz<br>CPU Level 2 Cache 550MHz<br>CPU Level 2 Cache ECC Check 600MHz<br>BIOS Update 400MHz<br>PS/2 Mouse Function Control 466MHz<br>USB Legacy Support 533MHz<br>OS/2 Onboard Memory > 64M 600MHz<br>▶ Chip Configuration 667MHz<br>▶ I/O Device Configuration 733MHz<br>▶ PCI Configuration 800MHz<br>▶ Shadow Configuration 866MHz |          |       |      |      | Item Specific Help<br><br>Since you use a new CPU or reinstall your CPU, the system boots up at the CPU external frequency of 66MHz to make sure the system can enter setup menu. Now, you can adjust the CPU internal frequency as you wish. If the frequency is adjusted too high, the system may hang. Please turn off the system and then restart to set the frequency. |
| F1 Help ↑↓ Select Item -/+ Change Values F5 Setup Defaults<br>ESC Exit ↔ Select Menu Enter Select ▶ Sub-Menu F10 Save and Exit                                                                                                                                                                                                                                                                                                                                                                                                |          |       |      |      |                                                                                                                                                                                                                                                                                                                                                                             |

### For processors with unlocked frequency multiplier

# 4. BIOS SETUP

## System Hangup

If your system crashes or hangs due to improper frequency settings, power OFF your system and restart. The system will start up in safe mode running at a bus speed of 66MHz and enter BIOS setup.

| AwardBIOS Setup Utility        |           |       |      |                                                                                                                         |
|--------------------------------|-----------|-------|------|-------------------------------------------------------------------------------------------------------------------------|
| Main                           | Advanced  | Power | Boot | Exit                                                                                                                    |
| CPU Internal Frequency         | [ 933MHz] |       |      | Item Specific Help                                                                                                      |
| CPU Frequency Multiple         | [7.0x]    |       |      |                                                                                                                         |
| FSB/SDRAM/PCI Freq. Ratio      | [8/6/2]   |       |      |                                                                                                                         |
| CPU External (FSB) Freq. (MHz) | [133]     |       |      | During the last boot-up, your system hung for an improper CPU Internal Frequency setting. Your system is now working in |
| CPU Vcore                      | [2.00V]   |       |      |                                                                                                                         |
| CPU Level 1 Cache              | [Enabled] |       |      |                                                                                                                         |
| CPU Level 2 Cache              | [Enabled] |       |      |                                                                                                                         |

**Cause for Hangup: Improper CPU Internal Frequency**

| AwardBIOS Setup Utility        |           |       |      |                                                                                                           |
|--------------------------------|-----------|-------|------|-----------------------------------------------------------------------------------------------------------|
| Main                           | Advanced  | Power | Boot | Exit                                                                                                      |
| CPU Internal Frequency         | [Manual]  |       |      | Item Specific Help                                                                                        |
| CPU Frequency Multiple         | [8.0x]    |       |      |                                                                                                           |
| FSB/SDRAM/PCI Freq. Ratio      | [8/6/2]   |       |      |                                                                                                           |
| CPU External (FSB) Freq. (MHz) | [133]     |       |      | During the last boot-up, your system hung for an improper CPU Internal Frequency Multiple. Your system is |
| CPU Vcore                      | [2.00V]   |       |      |                                                                                                           |
| CPU Level 1 Cache              | [Enabled] |       |      |                                                                                                           |
| CPU Level 2 Cache              | [Enabled] |       |      |                                                                                                           |

**Cause for Hangup: Improper CPU Frequency Multiple**  
(For processors with unlocked frequency multiplier only)

| AwardBIOS Setup Utility        |           |       |      |                                                                                                                    |
|--------------------------------|-----------|-------|------|--------------------------------------------------------------------------------------------------------------------|
| Main                           | Advanced  | Power | Boot | Exit                                                                                                               |
| CPU Internal Frequency         | [ Manual] |       |      | Item Specific Help                                                                                                 |
| CPU Frequency Multiple         | [7.0x]    |       |      |                                                                                                                    |
| FSB/SDRAM/PCI Freq. Ratio      | [8/6/2]   |       |      |                                                                                                                    |
| CPU External (FSB) Freq. (MHz) | [153]     |       |      | During the last boot-up, your system hung for improper FSB/SDRAM/PCI Frequency Ratio or/and CPU External Frequency |
| CPU Vcore                      | [2.00V]   |       |      |                                                                                                                    |
| CPU Level 1 Cache              | [Enabled] |       |      |                                                                                                                    |
| CPU Level 2 Cache              | [Enabled] |       |      |                                                                                                                    |

**Cause for Hangup: Improper FSB/SDRAM/PCI Freq. Ratio or CPU External (FSB) Freq. (MHz)**

# 4. BIOS SETUP

## 4.4.1 Chip Configuration

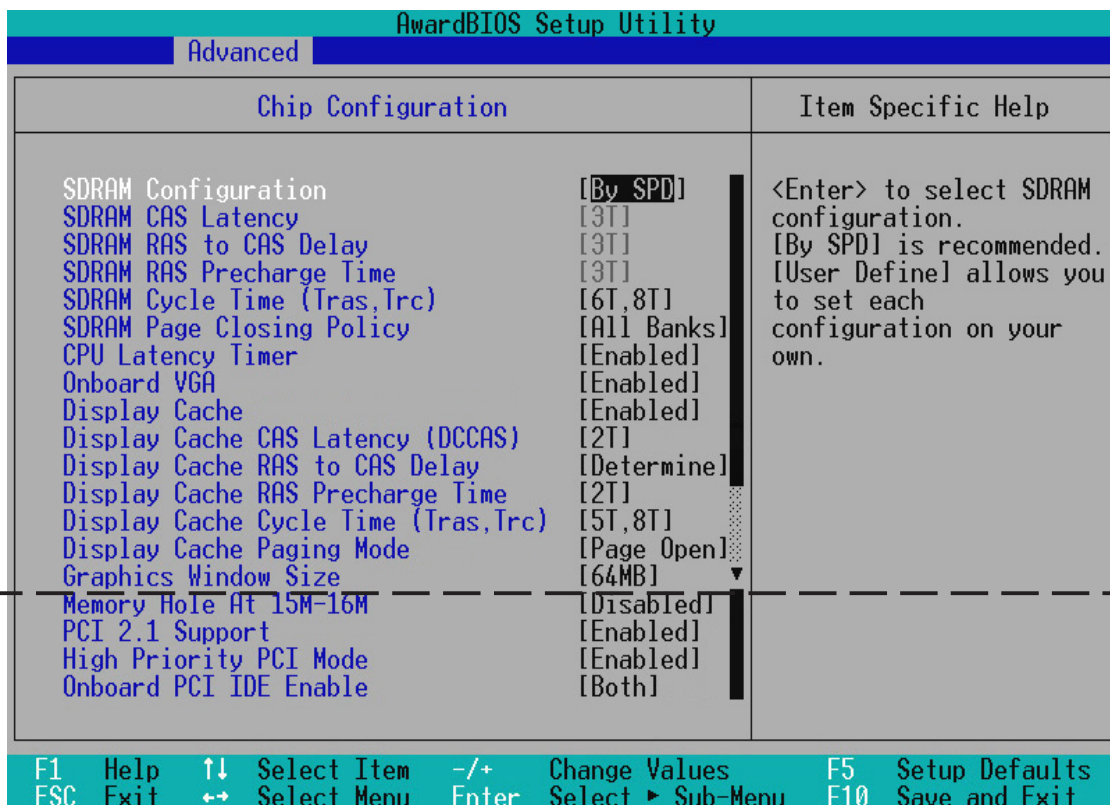

(scroll down to see more items, as shown here)

### SDRAM Configuration [By SPD]

This sets the optimal timings for items 2–4, depending on the memory modules that you are using. Default setting is [By SPD], which configures items 2–4 by reading the contents in the SPD (Serial Presence Detect) device. The EEPROM on the memory module stores critical parameter information about the module, such as memory type, size, speed, voltage interface, and module banks. Configuration options: [User Define] [7ns (143MHz)] [8ns (125MHz)] [By SPD]

### SDRAM CAS Latency

This controls the latency between the SDRAM read command and the time that the data actually becomes available. **NOTE:** To make changes to this field, the **SDRAM Configuration** field must be set to [User Define].

### SDRAM RAS to CAS Delay

This controls the latency between the SDRAM active command and the read/write command. **NOTE:** To make changes to this field, the **SDRAM Configuration** field must be set to [User Define].

## 4. BIOS SETUP

---

### **SDRAM RAS Precharge Time**

This controls the idle clocks after issuing a precharge command to the SDRAM. **NOTE:** To make changes to this field, the **SDRAM Configuration** field must be set to [User Define].

### **SDRAM Cycle Time (Tras, Trc) [6T, 8T]**

This feature controls the number of SDRAM clocks used per access cycle. Configuration options: [5T, 7T] [6T, 8T]

### **SDRAM Page Closing Policy [All Banks]**

This feature controls whether the graphic and memory controller hub will precharge one or all banks after a page miss. Configuration options: [One Bank] [All Banks]

### **CPU Latency Timer [Enabled]**

Configuration options: [Disabled] [Enabled]

### **Onboard VGA [Enabled]**

Leave on default setting if you want to use the onboard VGA. If this field is disabled, all **Display Cache** configurations will not be available. Configuration options: [Disabled] [Enabled]

### **Display Cache [Enabled]**

Load default settings if you want to use the onboard display cache. If this field is disabled, all the other **Display Cache** configurations will not be available. Configuration options: [Disabled] [Enabled]

### **Display Cache CAS Latency (DCCAS) [2T]**

Configuration options: [2T] [3T]

### **Display Cache RAS to CAS Delay [Determined by DCCAS]**

With the default setting [Determined by DCCAS], this field has the same configuration as **Display Cache CAS Latency (DCCAS)**. Configuration options: [Determined by DCCAS] [2T]

### **Display Cache RAS Precharge Time [2T]**

Configuration options: [2T] [3T]

### **Display Cache Cycle Time (Tras, Trc) [5T, 8T]**

Configuration options: [5T, 8T] [7T, 10T]

### **Display Cache Paging Mode [Page Open Mode]**

Configuration options: [Page Open Mode] [Page Close Mode]

### **Graphics Window Size [64MB]**

This feature allows you to select the size of mapped memory for AGP graphic data. Configuration options: [64MB] [32MB]

## 4. BIOS SETUP

---

### **Memory Hole At 15M-16M [Disabled]**

This field allows you to reserve an address space for ISA expansion cards that require it. Setting the address space to a particular setting will make that memory space unavailable to the system. Expansion cards can only access memory up to 16MB. Configuration options: [Disabled] [Enabled]

### **PCI 2.1 Support [Enabled]**

This function allows you to enable or disable PCI 2.1 features including passive release and delayed transaction. Configuration options: [Disabled] [Enabled]

### **High Priority PCI Mode [Enabled]**

This field allows you to give PCI slot 1 a higher priority. You may want to leave on the default setting if you are using an IEEE-1394 PCI card. Configuration options: [Disabled] [Enabled]

### **Onboard PCI IDE Enable [Both]**

You can select to enable the primary IDE channel, secondary IDE channel, both, or disable both channels. Configuration options: [Both] [Primary] [Secondary] [Disabled]

# 4. BIOS SETUP

## 4.4.2 I/O Device Configuration

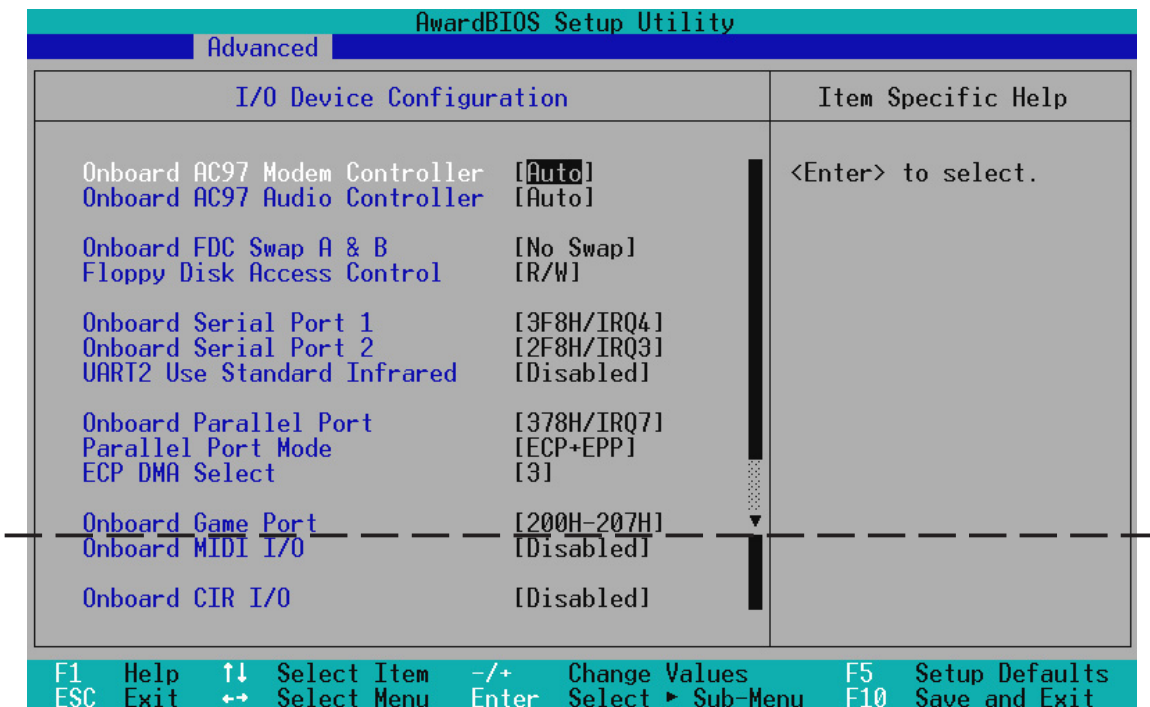

(scroll down to see more items, as shown here)

### Onboard AC97 Modem Controller, Audio Controller [Auto]

[Auto] allows the motherboard's BIOS to detect whether you are using any modem/ audio device. If a modem/audio device is detected, the onboard modem/audio controller will be enabled; if no modem/audio device is detected, the onboard modem/audio controller will be disabled. If you have conflicts with the onboard modem/audio controller, you may set the appropriate field to [Disabled]. Configuration options: [Disabled] [Auto]

### Onboard FDC Swap A & B [No Swap]

This field allows you to reverse the hardware drive letter assignments of your floppy disk drives. Configuration options: [No Swap] [Swap AB]

### Floppy Disk Access Control [R/W]

When set to [Read Only], this field protects files from being copied to floppy disks by allowing reads from the floppy disk drive but not writes. The setup default [R/W] allows both reads and writes. Configuration options: [R/W] [Read Only]

### Onboard Serial Port 1 [3F8H/IRQ4], Onboard Serial Port 2 [2F8H/IRQ3]

These fields allow you to set the addresses for the onboard serial connectors. Serial Port 1 and Serial Port 2 must have different addresses. Configuration options: [3F8H/IRQ4] [2F8H/IRQ3] [3E8H/IRQ4] [2E8H/IRQ10] [Disabled]

## 4. BIOS SETUP

---

### **UART2 Use Standard Infrared [Disabled]**

When enabled, this field activates the onboard standard infrared feature and sets the second serial UART to support the infrared module connector on the motherboard. If your system already has a second serial port connected to the onboard COM2 connector, it will no longer work if you enable the infrared feature. See **IrDA-Compliant Infrared Module Connector** in *3.8 External Connectors*. Configuration options: [Disabled] [Enabled]

### **Onboard Parallel Port [378H/IRQ7]**

This field sets the address of the onboard parallel port connector. If you disable this feature, **Parallel Port Mode** and **ECP DMA Select** configurations will not be available. Configuration options: [Disabled] [378H/IRQ7] [278H/IRQ5]

### **Parallel Port Mode [ECP+EPP]**

This field allows you to set the operation mode of the parallel port. [Normal] allows normal-speed operation but in one direction only; [EPP] allows bidirectional parallel port operation; [ECP] allows the parallel port to operate in bidirectional DMA mode; [ECP+EPP] allows normal speed operation in a two-way mode. Configuration options: [Normal] [EPP] [ECP] [ECP+EPP]

### **ECP DMA Select [3]**

This field allows you to configure the parallel port DMA channel for the selected **ECP** mode. This selection is available only if you select [ECP] or [ECP+EPP] in **Parallel Port Mode** above. Configuration options: [1] [3] [Disabled]

### **Onboard Game Port [200H-207H]**

This field sets the address of the onboard game port connector. Configuration options: [Disabled] [200H-207H] [208H-20FH]

### **Onboard MIDI I/O [Disabled]**

This field sets the address of the onboard MIDI connector. Configuration options: [Disabled] [330H-331H] [300H-301H]

### **Onboard MIDI IRQ [xx]**

This field is not available if you select [Disabled] for the **Onboard MIDI I/O** field. Configuration options: [3] [4] [5] [7] [9] [10] [11] [12] [14] [15]

### **Onboard CIR I/O [Disabled]**

This field sets the address of the onboard Consumer IR connector. Configuration options: [Disabled] [2E0-2E8H] [3E0-3E8H]

### **Onboard CIR IRQ [xx]**

This field is not available if you select [Disabled] for the **Onboard CIR I/O** field. Configuration options: [3] [4] [5] [7] [9] [10] [11] [12] [14] [15]



# 4. BIOS SETUP

## 4.4.3 PCI Configuration

The screenshot shows the AwardBIOS Setup Utility interface. At the top, it says 'AwardBIOS Setup Utility' and 'Advanced'. The main window is titled 'PCI Configuration' and is divided into two columns: 'Item Specific Help' and a list of configuration options. The options include Slot 1 IRQ (set to [Auto]), PCI/VGA Palette Snoop ([Disabled]), PCI Latency Timer ([32]), SYMBIOS SCSI BIOS ([Auto]), USB Function ([Enabled]), ONB VGA BIOS First ([No]), and Onboard LAN Boot ROM ([Disabled]). There are also three sub-menu options for PCI/PNP ISA Resource Exclusion. At the bottom, a legend lists keyboard shortcuts: F1 Help, ESC Exit, ↑↓ Select Item, ↔ Select Menu, -/+ Change Values, Enter Select, F5 Setup Defaults, and F10 Save and Exit.

| Item Specific Help        | Configuration Options                |
|---------------------------|--------------------------------------|
| <Enter> to select an IRQ. | Slot 1 IRQ [Auto]                    |
|                           | PCI/VGA Palette Snoop [Disabled]     |
|                           | PCI Latency Timer [ 32]              |
|                           | SYMBIOS SCSI BIOS [Auto]             |
|                           | USB Function [Enabled]               |
|                           | ONB VGA BIOS First [No]              |
|                           | Onboard LAN Boot ROM [Disabled]      |
|                           | ▶ PCI/PNP ISA IRQ Resource Exclusion |
|                           | ▶ PCI/PNP ISA DMA Resource Exclusion |
|                           | ▶ PCI/PNP ISA UMB Resource Exclusion |

### Slot 1 IRQ [Auto]

This field sets how IRQ use is determined for the PCI slot. The default setting for each field is [Auto], which utilizes auto-routing to determine IRQ use. Configuration options: [Auto] [NA] [3] [4] [5] [7] [9] [10] [11] [12] [14] [15]

### PCI/VGA Palette Snoop [Disabled]

Some nonstandard VGA cards, such as graphics accelerators or MPEG video cards, may not show colors properly. The setting [Enabled] should correct this problem. Otherwise, leave this on the default setting of [Disabled]. Configuration options: [Disabled] [Enabled]

### PCI Latency Timer [32]

Leave on default setting for best performance vs. stability.

### SYMBIOS SCSI BIOS [Auto]

[Auto] allows the motherboard's BIOS to detect whether you have a Symbios SCSI card. If the Symbios SCSI card is detected, the motherboard's Symbios BIOS will be enabled; if no Symbios SCSI card is detected, the onboard Symbios SCSI BIOS will be disabled.

[Disabled] will disable the motherboard's Symbios SCSI BIOS so that the BIOS on an add-on Symbios SCSI card can be used. If your Symbios SCSI card does not have a BIOS, the Symbios SCSI card will not function. Configuration options: [Auto] [Disabled]

# 4. BIOS SETUP

## USB Function [Enabled]

This motherboard supports Universal Serial Bus (USB) devices. Set to [Enabled] if you want to use USB devices. Configuration options: [Disabled] [Enabled]

## ONB VGA BIOS First [No]

This field, when set to [Yes], gives priority to the onboard VGA BIOS over other VGA controllers. Configuration options: [No] [Yes]

## Onboard LAN Boot ROM [Disabled]

When the onboard LAN boot ROM is enabled, you may choose to boot from an Intel UNDI PXE-compliant network that your system is connected to. To do so, you must restart the system after setting this field to [Enabled], enter BIOS Setup, go to the Boot menu, and select the option that contains *Intel UNDI, PXE* under **Other Boot Device**. Configuration options: [Disabled] [Enabled]

## PCI/PNP ISA IRQ Resource Exclusion

| AwardBIOS Setup Utility            |                                                                                                                  |
|------------------------------------|------------------------------------------------------------------------------------------------------------------|
| Advanced                           |                                                                                                                  |
| PCI/PNP ISA IRQ Resource Exclusion | Item Specific Help                                                                                               |
| IRQ 3 Used By ISA [No/ICU]         | Select [Yes] if this IRQ is required by a legacy ISA card and you are not using ICU; otherwise, select [No/ICU]. |
| IRQ 4 Used By ISA [No/ICU]         |                                                                                                                  |
| IRQ 5 Used By ISA [No/ICU]         |                                                                                                                  |
| IRQ 7 Used By ISA [No/ICU]         |                                                                                                                  |
| IRQ 9 Used By ISA [No/ICU]         |                                                                                                                  |
| IRQ 10 Used By ISA [No/ICU]        |                                                                                                                  |
| IRQ 11 Used By ISA [No/ICU]        |                                                                                                                  |
| IRQ 12 Used By ISA [No/ICU]        |                                                                                                                  |
| IRQ 14 Used By ISA [No/ICU]        |                                                                                                                  |
| IRQ 15 Used By ISA [No/ICU]        |                                                                                                                  |

F1 Help   ↑↓ Select Item   -/+ Change Values   F5 Setup Defaults  
ESC Exit   ↔ Select Menu   Enter Select Sub-Menu   F10 Save and Exit

## IRQ XX Used By ISA [No/ICU]

These fields indicate whether or not the displayed IRQ for each field is being used by a legacy (non-PnP) ISA card. The default value indicates either that the displayed IRQ is not used or that ISA Configuration Utility (ICU) is being used to determine if an ISA card is using that IRQ. If you install a legacy ISA card that requires a unique IRQ and you are not using an ICU, you must set the field for that IRQ to [Yes]. For example: If you install a legacy ISA card that requires IRQ 10, then set **IRQ10 Used By ISA** to [Yes]. Configuration options: [No/ICU] [Yes]

# 4. BIOS SETUP

## PCI/PNP ISA DMA Resource Exclusion

| AwardBIOS Setup Utility                                                                |                                                                                                                          |
|----------------------------------------------------------------------------------------|--------------------------------------------------------------------------------------------------------------------------|
| Advanced                                                                               |                                                                                                                          |
| PCI/PNP ISA DMA Resource Exclusion                                                     | Item Specific Help                                                                                                       |
| DMA 1 Used By ISA [No/ICU]<br>DMA 3 Used By ISA [No/ICU]<br>DMA 5 Used By ISA [No/ICU] | Select [Yes] if this DMA channel is required by a legacy ISA card and you are not using ICU; otherwise, select [No/ICU]. |

F1 Help ↑↓ Select Item -/+ Change Values F5 Setup Defaults  
ESC Exit ↔ Select Menu Enter Select ► Sub-Menu F10 Save and Exit

### DMA x Used By ISA [No/ICU]

These fields indicate whether or not the displayed DMA channel for each field is being used by a legacy (non-PnP) ISA card. The default setting indicates either that the displayed DMA channel is not used or an ICU is being used to determine if an ISA card is using that channel. If you install a legacy ISA card that requires a unique DMA channel, and you are not using an ICU, you must set the field for that channel to [Yes]. Configuration options: [No/ICU] [Yes]

## PCI/PNP ISA UMB Resource Exclusion

| AwardBIOS Setup Utility            |                                                                     |
|------------------------------------|---------------------------------------------------------------------|
| Advanced                           |                                                                     |
| PCI/PNP ISA UMB Resource Exclusion | Item Specific Help                                                  |
| ISA MEM Block BASE [No/ICU]        | This is for some ISA add-on cards whose UMB can't be auto-detected. |

F1 Help ↑↓ Select Item -/+ Change Values F5 Setup Defaults  
ESC Exit ↔ Select Menu Enter Select ► Sub-Menu F10 Save and Exit

# 4. BIOS SETUP

## ISA MEM Block BASE [No/ICU]

This field allows you to set the base address and block size of a legacy ISA card that uses any memory segment within the C800 and DFFF address range. If you have such a card and you are not using an ICU to specify its address range, select a base address from the six available options; the **ISA MEM Block SIZE** field will then appear for selecting the block size. If you have more than one legacy ISA card in your system that requires the use of this address range, you can increase the block size to 8K, 16K, 32K, or 64K. If you are using an ICU to accomplish this task, leave **ISA MEM Block BASE** to its default setting of [No/ICU]. Configuration options: [No/ICU] [C800] [CC00] [D000] [D400] [D800] [DC00]

## 4.4.4 Shadow Configuration

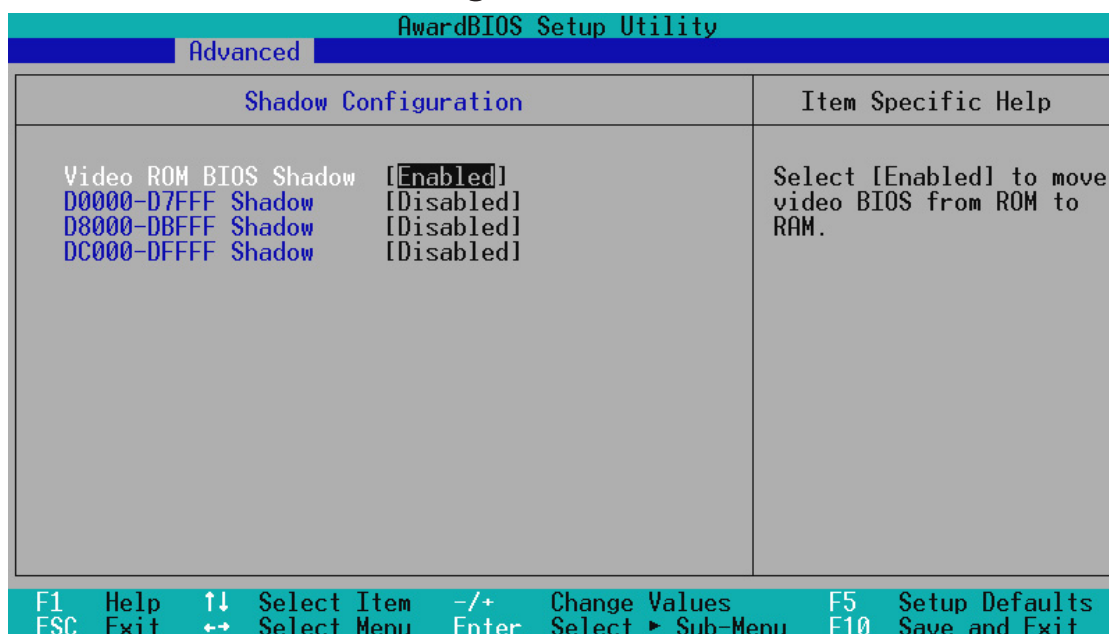

### Video ROM BIOS Shadow [Enabled]

This field allows you to change the video BIOS location from ROM to RAM. Relocating to RAM enhances system performance, as information access is faster than the ROM. Configuration options: [Disabled] [Enabled]

### D0000-DFFFF Shadow [Disabled]

These fields are used for shadowing other expansion card ROMs. If you install other expansion cards with ROMs on them, you will need to know which addresses the ROMs use to shadow them specifically. Shadowing a ROM reduces the memory available between 640K and 1024K by the amount used for this purpose. Configuration options: [Disabled] [Enabled]

# 4. BIOS SETUP

## 4.5 Power Menu

The Power menu allows you to reduce power consumption. This feature turns off the video display and shuts down the hard disk after a period of inactivity.

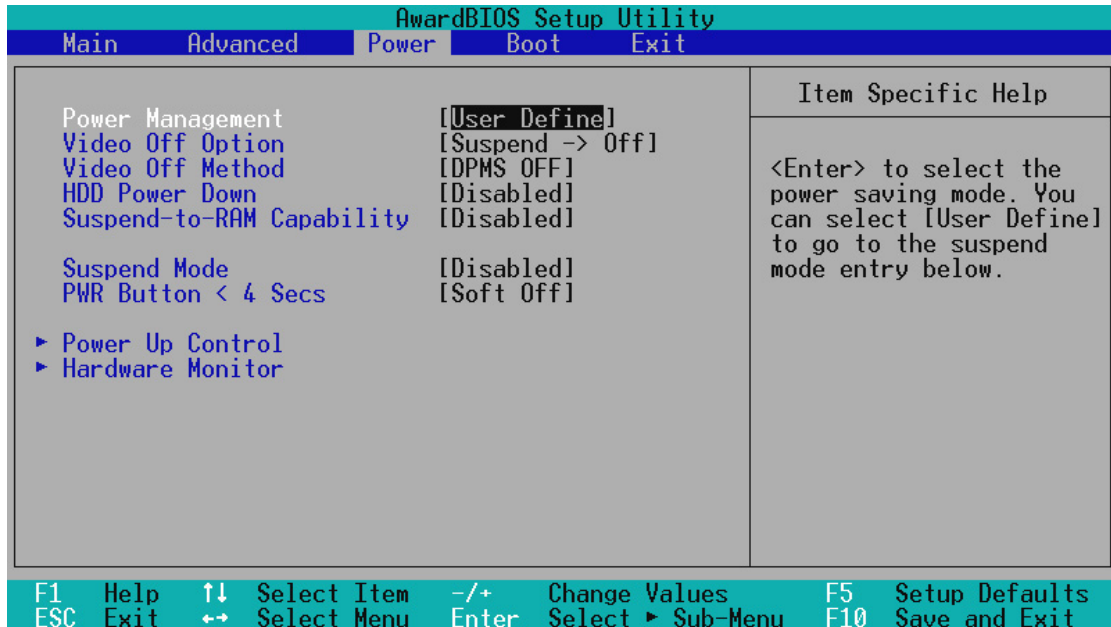

### Power Management [User Define]

This option must be enabled to use any of the automatic power saving features. If this menu item is set to [Disabled], power management features will not function regardless of other field settings on this menu. The [User Define] option allows you to make your own selections in the Power menu. When set to [Max Saving], system power will be conserved to its greatest amount. The **Suspend Mode** field will then be set to predefined value that ensures maximum power savings.

This field acts as the master control for the power management modes. [Max Saving] puts the system into power saving mode after a brief period of system inactivity; [Min Saving] is almost the same as [Max Saving] except that the system inactivity period is longer; [Disabled] disables the power saving features; [User Define] allows you to set power saving options according to your preference. Configuration options: [User Define] [Disabled] [Min Saving] [Max Saving]

**IMPORTANT:** Advanced Power Management (APM) should be installed to keep the system time updated when the computer enters suspend mode activated by the BIOS Power Management. For DOS environments, you need to add the statement, DEVICE=C:\DOS\POWER.EXE, to your CONFIG.SYS file. For Windows 3.x and Windows 95, you need to install Windows with the APM feature. For Windows 98 and later, APM is automatically installed. A battery and power cord icon labeled “Power Management” will appear in the “Control Panel.” Choose “Advanced” in the Power Management Properties dialog box.

## 4. BIOS SETUP

---

### **Video Off Option [Suspend -> Off ]**

This field determines when to activate the video off feature for monitor power management. Configuration options: [Always On] [Suspend -> Off]

### **Video Off Method [DPMS OFF]**

This field defines the video off features. The DPMS (Display Power Management System) feature allows the BIOS to control the video display card if it supports the DPMS feature. [Blank Screen] only blanks the screen (use this for monitors without power management or “green” features. If set up in your system, your screen saver will not display with [Blank Screen] selected). [V/H SYNC+Blank] blanks the screen and turns off vertical and horizontal scanning. Configuration options: [Blank Screen] [V/H SYNC+Blank] [DPMS Standby] [DPMS Suspend] [DPMS OFF] [DPMS Reduce ON]

### **HDD Power Down [Disabled]**

Shuts down any IDE hard disk drives in the system after a period of inactivity as set in this user-configurable field. This feature does not affect SCSI hard drives. Configuration options: [Disabled] [1 Min] [2 Min] [3 Min]...[15 Min]

### **Suspend-to-RAM Capability [Disabled]**

Suspend-to-RAM (STR) is an energy-saving feature. In Suspend-to-RAM state, all devices on the computer are turned off, except for the system RAM. Thus, the PC consumes less than 5 Watts of power. [Auto] allows the BIOS to detect if your power supply can supply at least 720mA on the +5VSB lead to support the STR function. If the power supply meets the requirement, the STR function will be enabled; if not, this function will be disabled. If the expansion cards you use on the motherboard do not support the STR function, you must leave this field on the default setting [Disabled]. Configuration options: [Auto] [Disabled]

### **Suspend Mode [Disabled]**

Sets the time period before the system goes into suspend mode. Configuration options: [Disabled] [1~2 Min] [2~3 Min] [4~5 Min] [8~9 Min] [20 Min]...[1 Hour]

### **PWR Button < 4 Secs [Soft off]**

When set to [Soft off], the ATX switch can be used as a normal system power-off button when pressed for less than 4 seconds. [Suspend] allows the button to have a dual function where pressing less than 4 seconds will place the system in sleep mode. Regardless of the setting, holding the ATX switch for more than 4 seconds will power off the system. Configuration options: [Soft off] [Suspend]

# 4. BIOS SETUP

## 4.5.1 Power Up Control

| AwardBIOS Setup Utility      |             |                                                                             |
|------------------------------|-------------|-----------------------------------------------------------------------------|
| Power                        |             |                                                                             |
| Power Up Control             |             | Item Specific Help                                                          |
| AC PWR Loss Restart          | [Disabled]  | <Enter> to select whether or not to restart the system after AC power loss. |
| PWR Up On Modem Act          | [Disabled]  |                                                                             |
| Wake On LAN                  | [Disabled]  |                                                                             |
| Wake On PS2 KB/PS2 Mouse/CIR | [Disabled]  |                                                                             |
| Wake Up By Keyboard          | [Space Bar] |                                                                             |
| Automatic Power Up           | [Disabled]  |                                                                             |

F1 Help ↑↓ Select Item -/+ Change Values F5 Setup Defaults  
ESC Exit ↔ Select Menu Enter Select ▶ Sub-Menu F10 Save and Exit

### AC PWR Loss Restart [Disabled]

This allows you to set whether you want your system to reboot after the power has been interrupted. [Disabled] leaves your system off and [Enabled] reboots your system. [Previous State] sets your system back to the state it is before the power interruption. Configuration options: [Disabled] [Enabled] [Previous State]

### PWR Up On Modem Act [Disabled]

This allows either settings of [Enabled] or [Disabled] for powering up the computer when the modem receives a call while the computer is in Soft-off mode. **NOTE:** The computer cannot receive or transmit data until the computer and applications are fully running. Thus connection cannot be made on the first try. Turning an external modem off and then back on while the computer is off causes an initialization string that will also cause the system to power on. Configuration options: [Disabled] [Enabled]

### Wake On LAN [Enabled]

Wake-On-LAN allows your computer to be booted from another computer via a network by sending a wake-up frame or signal. Configuration options: [Disabled] [Enabled]

**IMPORTANT:** This feature requires an optional network interface with Wake-On-LAN and an ATX power supply with at least 720mA +5V standby power.

## 4. BIOS SETUP

---

### **Wake On PS2 KB/PS2 Mouse/CIR [Disabled]**

Set this field to [Enabled] if you wish to use your PS2 keyboard, PS2 mouse, or Consumer IR device to power up your computer. This feature requires an ATX power supply that can supply at least 300mA on the +5VSB lead. The default is set to [Disabled] because not all computers have the appropriate ATX power supply. Your computer will not power ON if you set this to [Enabled] and do not have the appropriate ATX power supply. Configuration options: [Disabled] [Enabled]

### **Wake Up By Keyboard [Space Bar]**

When the previous setup item **Wake On PS2 KB/PS2 Mouse/CIR** is enabled, you may specify the key(s) to press to power up the computer. Configuration options: [Space Bar] [Ctrl-Esc] [Power Key]

### **Automatic Power Up [Disabled]**

This allows an unattended or automatic system power up. You may configure your system to power up at a certain time of the day by selecting [Everyday] or at a certain time and day by selecting [By Date]. Configuration options: [Disabled] [Everyday] [By Date]



# 4. BIOS SETUP

## 4.5.2 Hardware Monitor

| AwardBIOS Setup Utility |                    |                                                   |
|-------------------------|--------------------|---------------------------------------------------|
| Power                   |                    |                                                   |
| HardWare Monitor        | Item Specific Help |                                                   |
| MB Temperature          | 33°C/91°F          | <Enter> to switch between monitoring or ignoring. |
| CPU Temperature         | 61°C/141°F         |                                                   |
| CPU Fan Speed           | 7670RPM            |                                                   |
| Power Fan Speed         | 7500RPM            |                                                   |
| Chassis Fan Speed       | N/A                |                                                   |
| VCORE Voltage           | 2.0V               |                                                   |
| +3.3V Voltage           | 3.3V               |                                                   |
| +5V Voltage             | 5.0V               |                                                   |
| +12V Voltage            | 12.0V              |                                                   |
| -12V Voltage            | -12.0V             |                                                   |
| -5V Voltage             | - 5.0V             |                                                   |

F1 Help ↑↓ Select Item -/+ Change Values F5 Setup Defaults  
ESC Exit ↔ Select Menu Enter Select ► Sub-Menu F10 Save and Exit

### MB Temperature, CPU Temperature [xxx°C/xxxF]

The onboard hardware monitor is able to detect the MB (motherboard) and CPU temperatures. Set to [Ignore] only if necessary.

### CPU Fan, Power Fan, Chassis Fan Speed [xxxxRPM]

The onboard hardware monitor is able to detect the CPU fan speed, power supply fan speed, and the chassis fan speed in rotations per minute (RPM). The presence of the fans is automatically detected. Set to [Ignore] only if necessary.

### VCORE Voltage, +3.3V Voltage, +5V Voltage, +12V Voltage, -12V Voltage, -5V Voltage [xx.xV]

The onboard hardware monitor is able to detect the voltage output by the onboard voltage regulators. Set to [Ignore] only if necessary.

**NOTE:** If any of the monitored items is out of range, an error message will appear: “Hardware Monitor found an error. Enter Power setup menu for details”. You will then be prompted to “Press **F1** to continue, **DEL** to enter SETUP”.

# 4. BIOS SETUP

## 4.6 Boot Menu

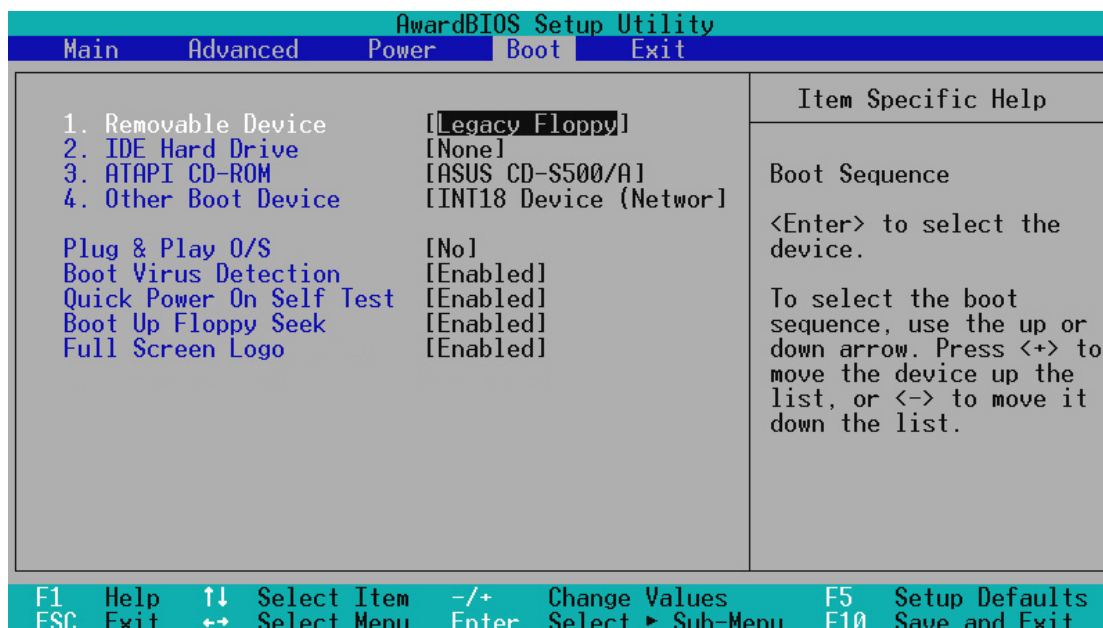

### Boot Sequence

The Boot menu allows you to select among the four possible types of boot devices listed using the up and down arrow keys. By using the <+> or <Space> key, you can promote devices, and by using the <-> key, you can demote devices. Promotion or demotion of devices alters the priority which the system uses to search for a boot device on system power up. Configuration options: [Removable Devices] [IDE Hard Drive] [ATAPI CD-ROM] [Other Boot Device]

### Removable Device [Legacy Floppy]

Configuration options: [Disabled] [Legacy Floppy] [LS120] [ZIP-100] [ATAPI MO]

### IDE Hard Drive

This field allows you to select which IDE hard disk drive to use in the boot sequence. Pressing [Enter] will show the product IDs of all connected IDE hard disk drives.

### ATAPI CD-ROM

This field allows you to select which ATAPI CD-ROM drive to use in the boot sequence. Pressing [Enter] will show the product IDs of all your connected ATAPI CD-ROM drives.

### Other Boot Device [INT18 Device (Network)]

Configuration options: [Disabled] [SCSI Boot Device] [INT18 Device (Network)]

## 4. BIOS SETUP

---

### **Plug & Play O/S [No]**

This field allows you to use a Plug-and-Play (PnP) operating system to configure the PCI bus slots instead of using the BIOS. When [Yes] is selected, interrupts may be reassigned by the OS. When a non-PnP OS is installed or you want to prevent reassigning of interrupt settings, select the default setting of [No]. Configuration options: [No] [Yes]

### **Boot Virus Detection [Enabled]**

This field allows you to set boot virus detection, ensuring a virus-free boot sector. The system halts and displays a warning message when it detects a virus. If this occurs, you can either allow the operation to continue or use a virus-free bootable floppy disk to restart and investigate your system. Configuration options: [Disabled] [Enabled]

### **Quick Power On Self Test [Enabled]**

This field speeds up the Power-On-Self Test (POST) routine by skipping retesting a second, third, and fourth time. Configuration options: [Disabled] [Enabled]

### **Boot Up Floppy Seek [Enabled]**

When enabled, the BIOS will seek the floppy disk drive to determine whether the drive has 40 or 80 tracks. Configuration options: [Disabled] [Enabled]

### **Full Screen Logo [Enabled]**

Configuration options: [Disabled] [Enabled]

# 4. BIOS SETUP

## 4.7 Exit Menu

Once you have made all of your selections from the various menus in the Setup program, you should save your changes and exit Setup. Select **Exit** from the menu bar to display the following menu:

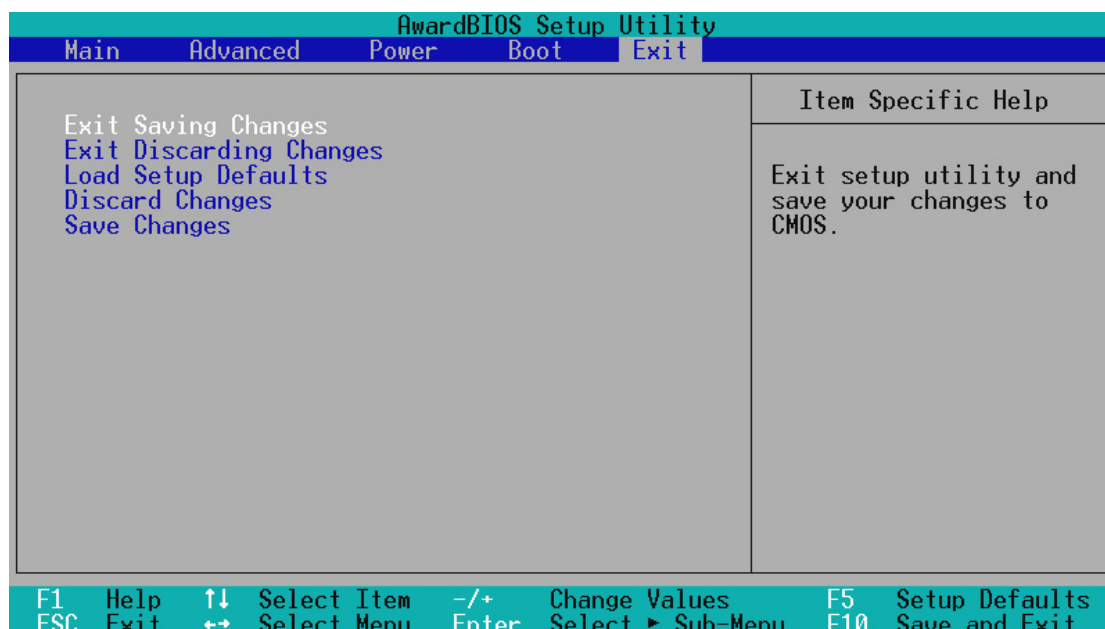

**NOTE:** Pressing <Esc> does not exit this menu. You must select one of the options from this menu or <F10> from the legend bar to exit this menu.

### Exit Saving Changes

Once you are finished making your selections, choose this option from the Exit menu to ensure the values you selected are saved to the CMOS RAM. The CMOS RAM is sustained by an onboard backup battery and stays on even when the PC is turned off. Once this option is selected, a confirmation is asked. Select [Yes] to save changes and exit.

**NOTE:** If you attempt to exit the Setup program without saving your changes, the program will prompt you with a message asking if you want to save your changes before exiting. Pressing <Enter> will then save changes while exiting.

### Exit Discarding Changes

This option should only be used if you do not want to save the changes you have made to the Setup program. If you have made changes to fields other than system date, system time, and password, the system will ask for confirmation before exiting.

# 4. BIOS SETUP

---

## Load Setup Defaults

This option allows you to load the default values for each of the parameters on the Setup menus. When this option is selected or if <F5> is pressed, a confirmation is requested. Select [Yes] to load default values. You can now select **Exit Saving Changes** or make other changes before saving the values to the non-volatile RAM.

## Discard Changes

This option allows you to discard the selections you made and restore the values you previously saved. After selecting this option, a confirmation is requested. Select [Yes] to discard any changes and load the previously saved values.

## Save Changes

This option saves your selections without exiting the Setup program. You can then return to other menus and make changes. After selecting this option, all selections are saved and a confirmation is requested. Select [Yes] to save any changes to the non-volatile RAM.

# 4. BIOS SETUP

---

(This page was intentionally left blank.)

# 5. SOFTWARE SETUP

---

## 5.1 Operating Systems

Although ASUS motherboards passed testing on several operating systems, the operating system shown in these sections will be that of Microsoft's Windows 98. You should always use the latest operating system and updates when using new hardware to ensure full compliancy. For Windows 95, you must use OSR 2.0 or later. For Windows NT 4.0, you must use Service Pack 3.0 or later.

## 5.2 Starting Windows For the First Time

When you start Windows 98 for the first time after installing your motherboard, Windows will detect all plug-and-play devices. You can either follow the Add New Hardware Wizard to install the device drivers or click **Cancel**. When prompted to restart, select **No** and then follow the normal setup procedures later in this section.

**IMPORTANT:** Selecting **No** for the initial restart prompt is a necessary step because Windows may load an older display driver that is incompatible with the integrated VGA. Always use the driver available on the ASUS Support CD or an applicable driver update from your ASUS vendor or the ASUS web site.

**NOTE:** Because there are various motherboard settings, options, and expansion cards, the following can only be used as a general reference and not an exact reflection of your system.

# 5. SOFTWARE SETUP

## 5.2.1 PCI Ethernet Controller Found

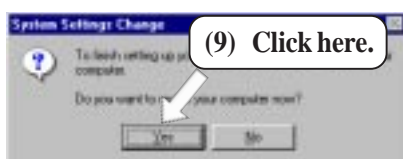
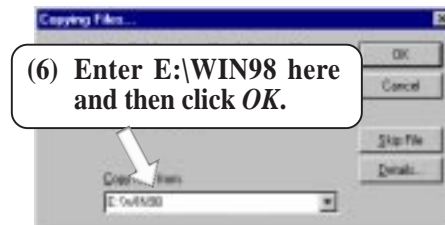



# 5. SOFTWARE SETUP

## 5.3 ASUS Smart Motherboard Support CD

**NOTE:** The support CD contents are subject to change at any time without notice.

To begin using your support CD disc, just insert it into your CD-ROM drive and the support CD installation menu should appear. If the menu does not appear, double click or run **E:\ASSETUP.EXE** (assuming that your CD-ROM drive is drive **E:**).

### 5.3.1 Support CD Main Menu

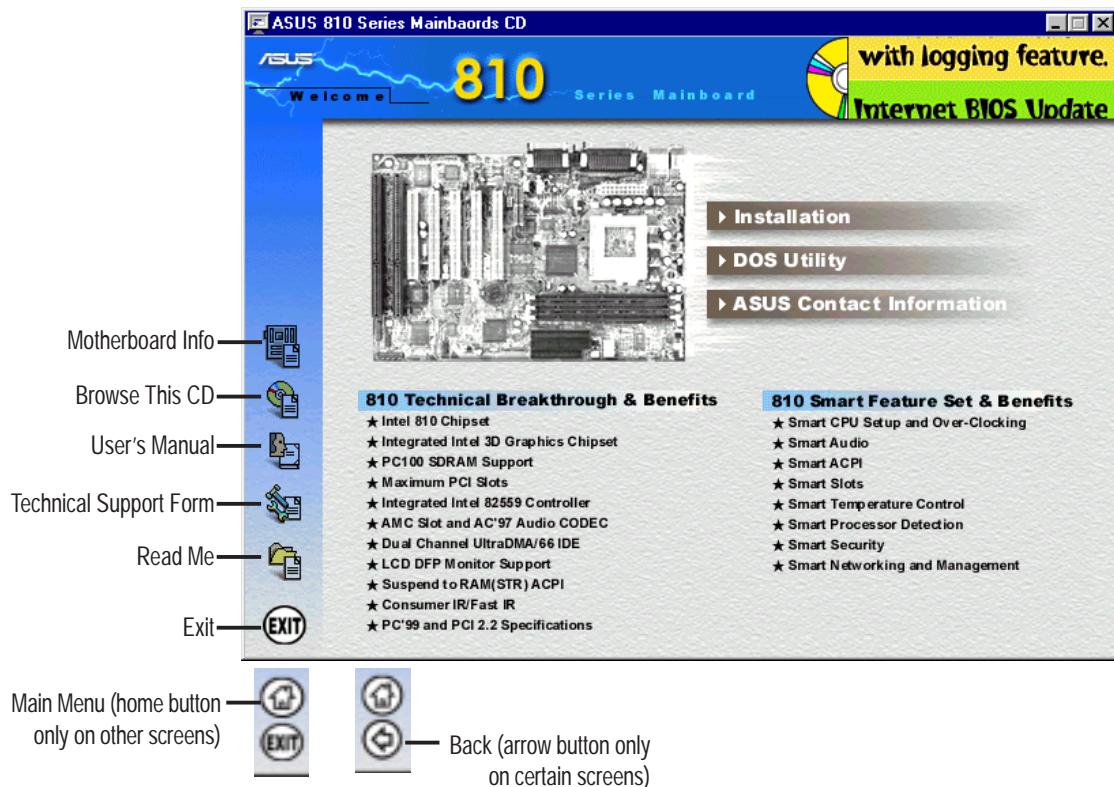

### Navigation Button Descriptions

**Motherboard Info** displays information on your motherboard, BIOS, and CPU.

**Browse This CD** allows you to see the contents of the ASUS Support CD.

**User's Manual** displays the motherboard user's manual in pdf format.

**Technical Support Form** opens up a blank Technical Support Request Form for you to fill and print out when you run into technical difficulties and need technical assistance.

**Read Me** opens up a file containing additional notes.

**Home** returns you to the main menu of the support CD. (only on other screens)

**Exit** allows you to close the support CD.

**Back** returns you one screen back on the support CD.

# 5. SOFTWARE SETUP

## 5.4 LDCM Local Setup

### System Requirements

- Intel® Pentium® microprocessor or higher.
- Operating system: Microsoft Windows 95 (can be OEM Service Release 2), or Windows 98, or Windows NT 4.0 (Service Pack 4 or later).
- Microsoft Internet Explorer 4.01 or higher.
- Memory: 16 MB of RAM for Windows 95/98; 24 MB of RAM for Windows NT (32 MB recommended).
- Disk storage space: 100 MB of available hard disk space to install; 40-100 MB of available hard disk space to run (depending on cluster size).
- Hardware system: DM or SM BIOS is required for full LDCM functionality.
- Protocols: IP (Winsock-enabled) communication protocol loaded on the client. An IP stack is required on the client, regardless of whether the client accesses the network.
- Monitor resolution of 600x800, 256 colors or greater.

Insert the Support CD that came with your motherboard into your CD-ROM drive or double-click the CD drive icon in **My Computer** to bring up the setup screen.

**NOTE:** LDCM will not run if another hardware monitoring utility, such as ASUS PC Probe, is installed. To uninstall any program, see **5.10 Uninstalling Programs**.

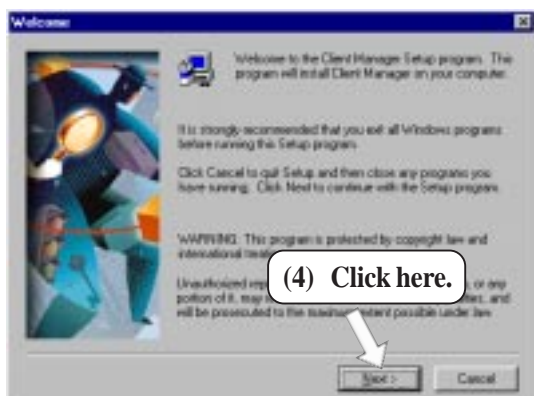

# 5. SOFTWARE SETUP

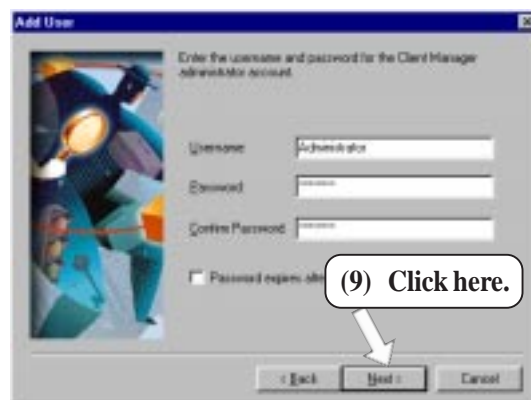
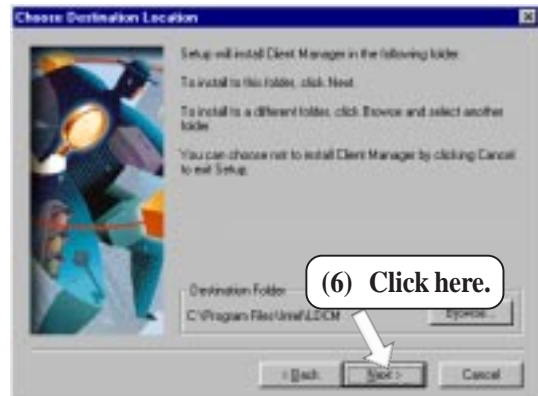
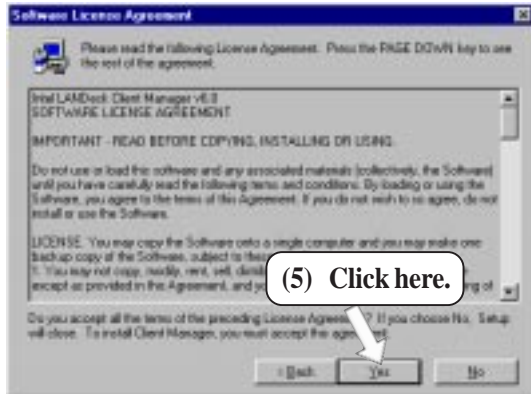

# 5. SOFTWARE SETUP

## 5.5 LDCM Administrator Setup

### System Requirements

- Intel® Pentium® microprocessor or higher.
- Operating system: Microsoft Windows 95 (can be OEM Service Release 2), or Windows 98, or Windows NT 4.0 (Service Pack 4 or later).
- Microsoft Internet Explorer 4.01 or higher.
- Memory: 16 MB of RAM for Windows 95/98; 24 MB of RAM for Windows NT (32 MB recommended).
- Disk storage space: 100 MB of available hard disk space to install; 40-100 MB of available hard disk space to run (depending on cluster size).
- Hardware system: DM or SM BIOS is required for full LDCM functionality.
- Protocols: IP (Winsock-enabled) communication protocol loaded on the client. An IP stack is required on the client, regardless of whether the client accesses the network.
- Monitor resolution of 600x800, 256 colors or greater.

Insert the Support CD that came with your motherboard into your CD-ROM drive or double-click the CD drive icon in **My Computer** to bring up the setup screen.

**NOTE:** LDCM will not run if another hardware monitoring utility, such as ASUS PC Probe, is installed. To uninstall any program, see *5.10 Uninstalling Programs*.

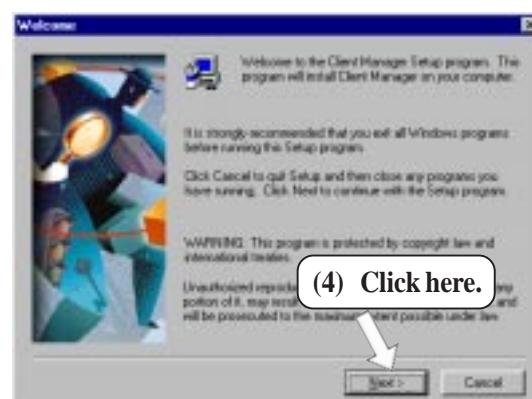

# 5. SOFTWARE SETUP

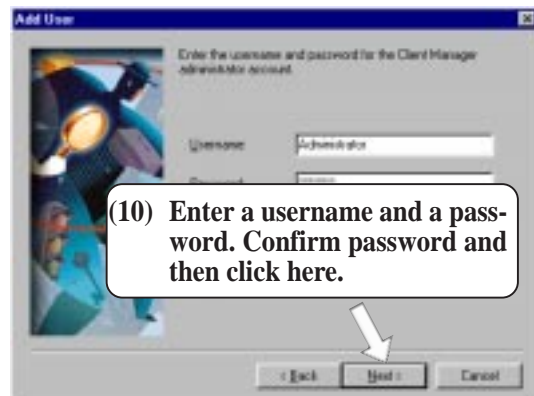
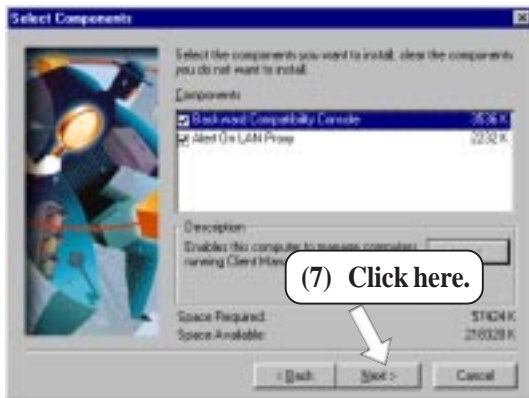
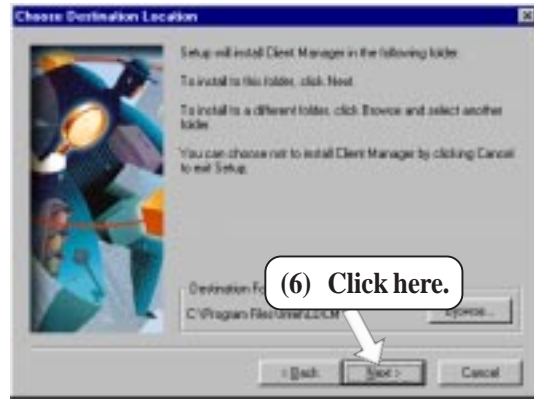
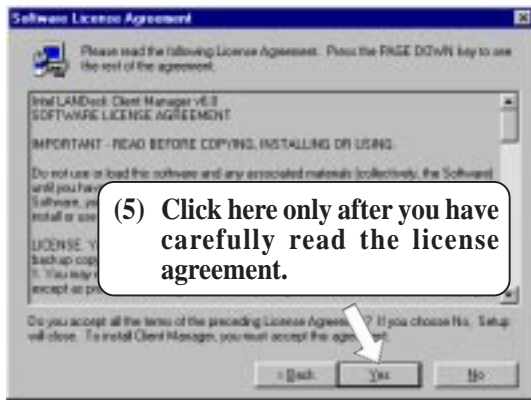

# 5. SOFTWARE SETUP

## 5.6 ASUS PC Probe

Insert the Support CD that came with your motherboard into your CD-ROM drive or double-click the CD drive icon in **My Computer** to bring up the setup screen.

**NOTE:** ASUS PC Probe will not run if another hardware monitoring utility, such as LDCM, is installed. To uninstall any program, see **5.10 Uninstalling Programs**.

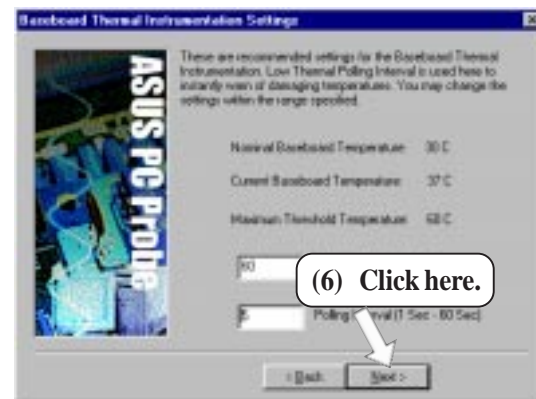
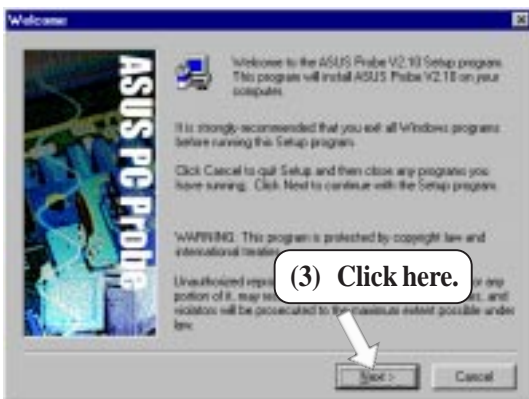

# 5. SOFTWARE SETUP

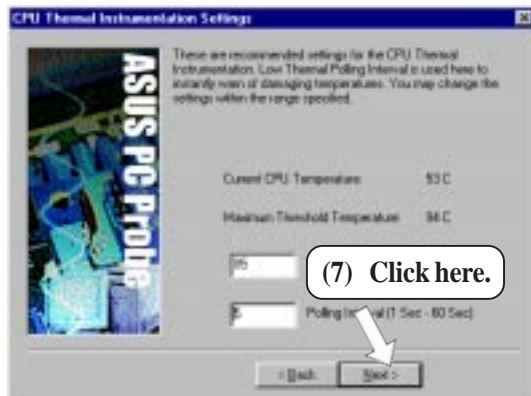

# 5. SOFTWARE SETUP

## 5.7 ASUS LiveUpdate

Insert the Support CD that came with your motherboard into your CD-ROM drive or double-click the CD drive icon in **My Computer** to bring up the setup screen.





# 5. SOFTWARE SETUP

## 5.8 Drivers

### 5.8.1 VGA Driver Setup

Insert the Support CD that came with your motherboard into your CD-ROM drive or double-click the CD drive icon in **My Computer** to bring up the setup screen.

**NOTE:** Before you install the VGA driver, make sure that the INF Update Utility is installed (see *5.9.1 INF Update Utility for 810 Chipset*)

(1) After your computer has restarted, double-click the CD drive icon and then click here.

(2) Click here.

(3) Click here.

(4) Click here.

(5) Click here.

(6) Click here.

(7) Click here.

(8) Browse to E:\VGA\WIN98 and then click here.

(9) To install other drivers or software, click here, and then click *Finish*.

5. SW SETUP  
Windows 98

# 5. SOFTWARE SETUP

## 5.8.2 Audio Driver Setup

Insert the Support CD that came with your motherboard into your CD-ROM drive or double-click the CD drive icon in **My Computer** to bring up the setup screen.

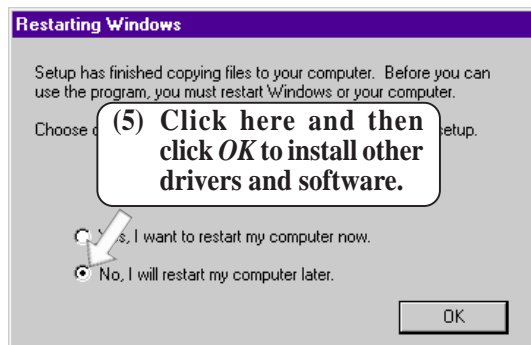
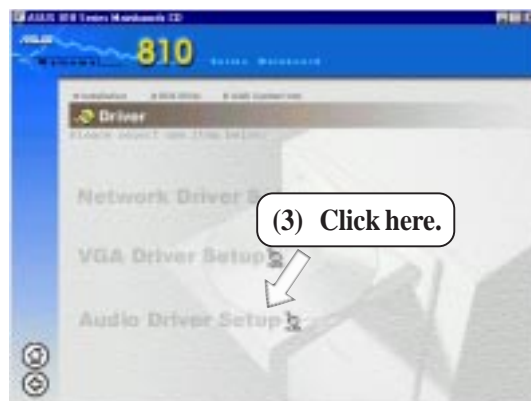

# 5. SOFTWARE SETUP

## 5.9 Other

### 5.9.1 INF Update Utility for 810 Chipset

Insert the Support CD that came with your motherboard into your CD-ROM drive or double-click the CD drive icon in **My Computer** to bring up the setup screen.

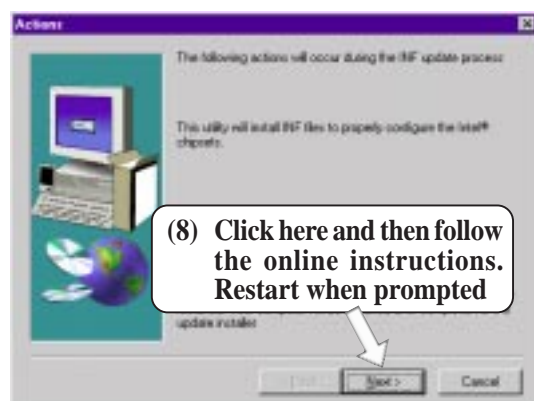
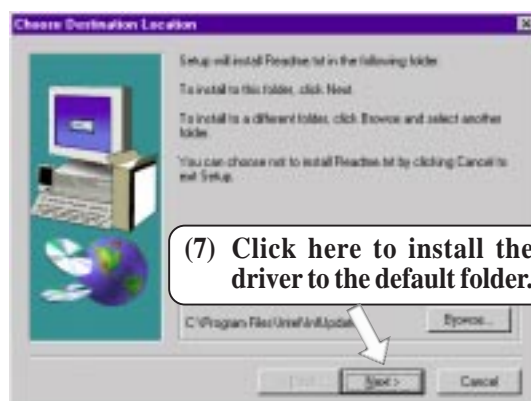
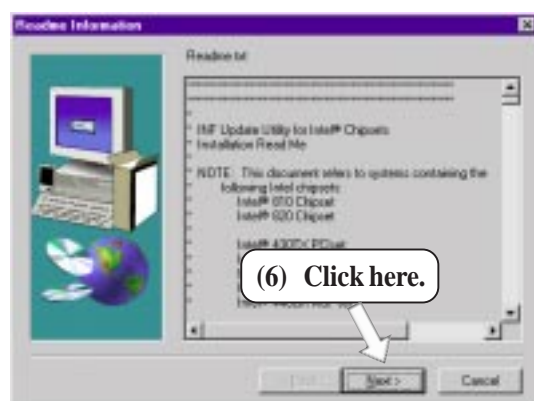
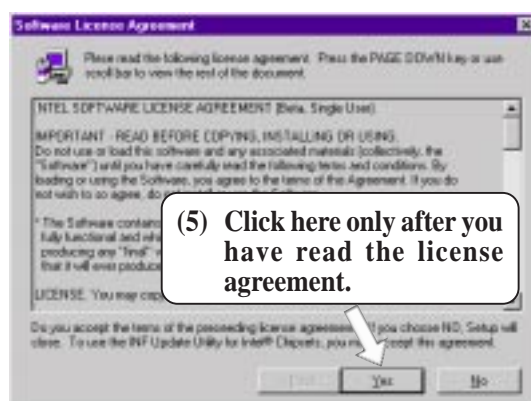

5. SW SETUP  
Windows 98

# 5. SOFTWARE SETUP

## 5.9.2 Intel Security Driver

Insert the Support CD that came with your motherboard into your CD-ROM drive or double-click the CD drive icon in **My Computer** to bring up the setup screen.

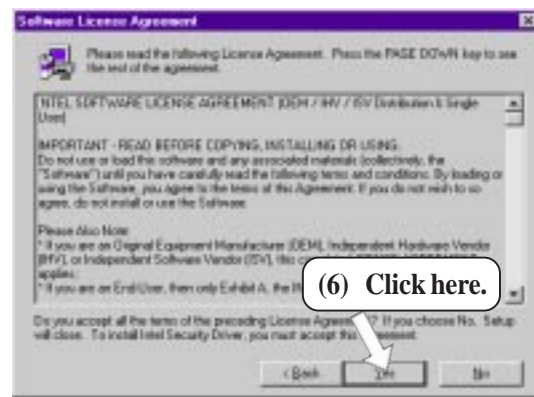
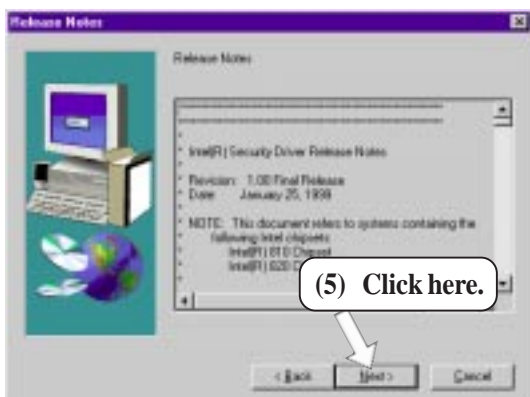

# 5. SOFTWARE SETUP

## 5.9.3 YAMAHA S-YXG50

Insert the Support CD that came with your motherboard into your CD-ROM drive or double-click the CD drive icon in **My Computer** to bring up the setup screen.

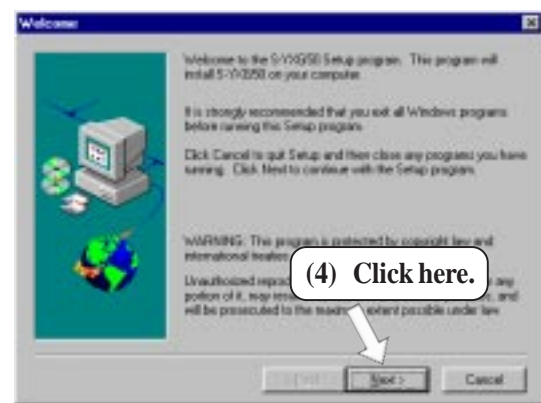

\* The serial number can be found on the software license agreement card.

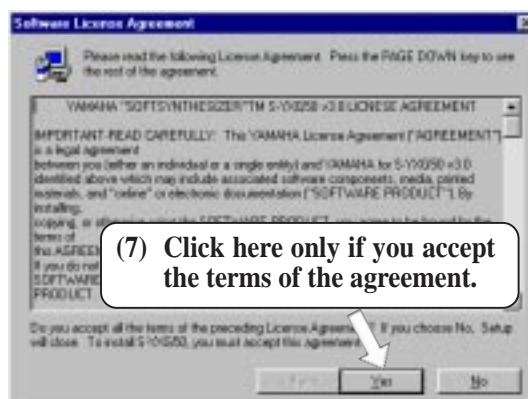

# 5. SOFTWARE SETUP

## 5.9.4 YAMAHA XGStudio

Insert the Support CD that came with your motherboard into your CD-ROM drive or double-click the CD drive icon in **My Computer** to bring up the setup screen.

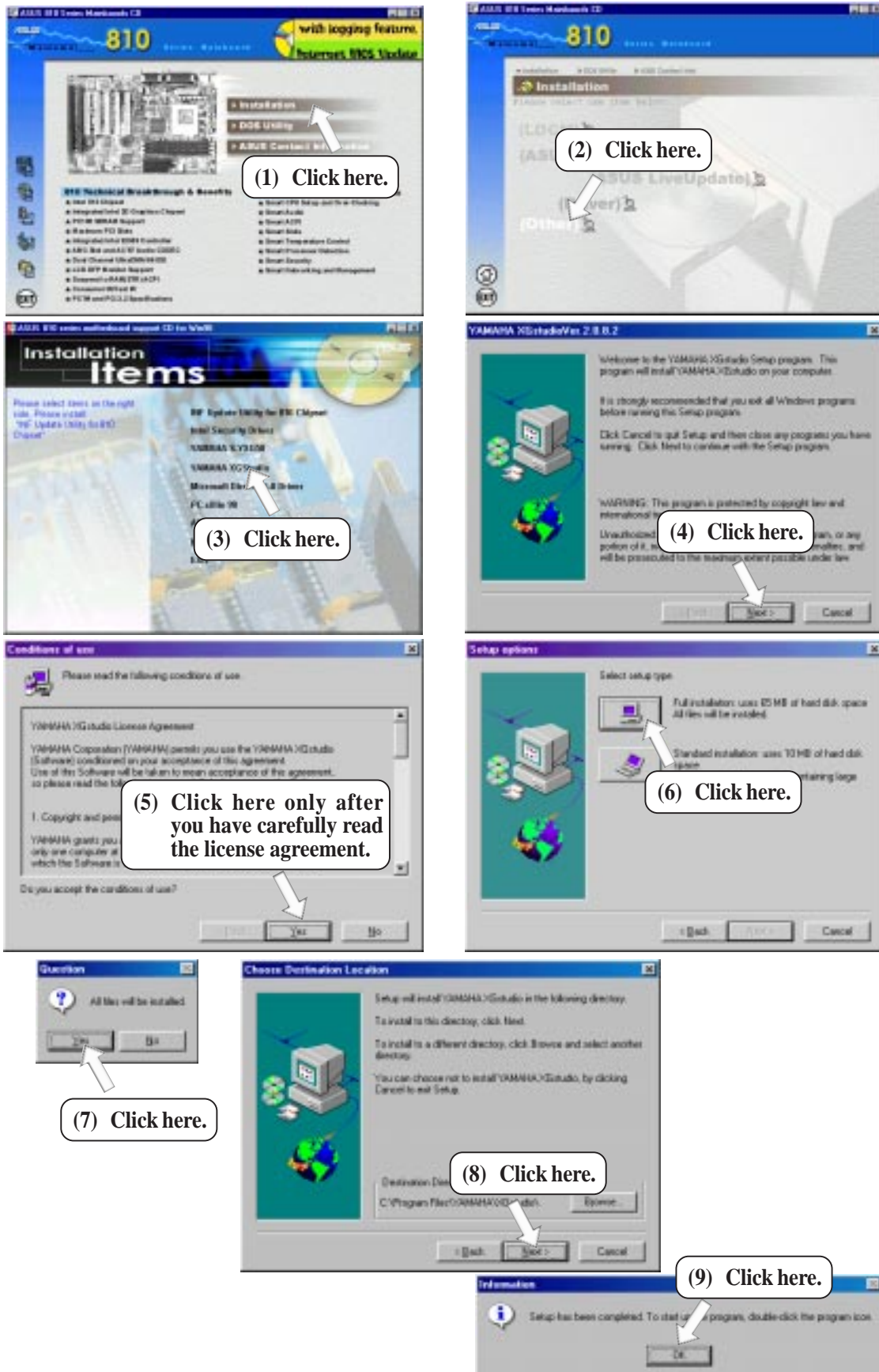

# 5. SOFTWARE SETUP

## 5.9.6 PC-cillin 98

Insert the Support CD that came with your motherboard into your CD-ROM drive or double-click the CD drive icon in **My Computer** to bring up the setup screen.

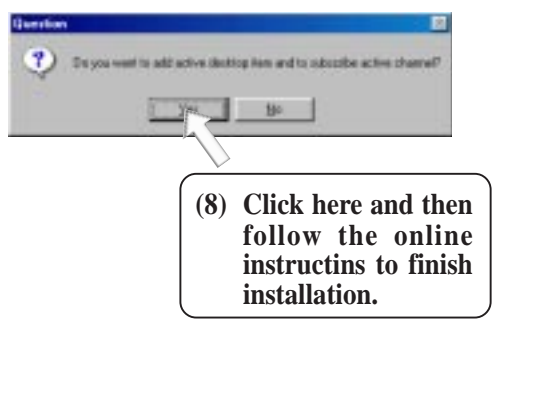
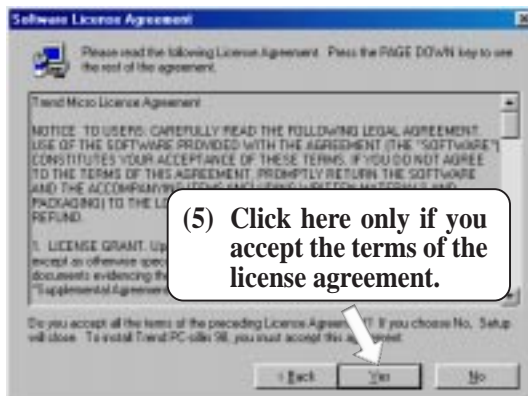

5. SAW SETUP  
Windows 98

# 5. SOFTWARE SETUP

## 5.9.7 Adobe Acrobat Reader V4.0

Insert the Support CD that came with your motherboard into your CD-ROM drive or double-click the CD drive icon in **My Computer** to bring up the setup screen.





# 5. SOFTWARE SETUP

## 5.10 Uninstalling Programs

Add/Remove Programs is a basic component within Windows. You may use this function if a program does not provide its own uninstall program.

**(1) Double-click here to open the Add/Remove Programs Properties dialog box.**

**(2) Select the program to remove and click here.**

**(3) Click here.**

# 5. SOFTWARE SETUP

---

(This page was intentionally left blank.)

# 6. SOFTWARE REFERENCE

## 6.1 Display Properties

The motherboard's built-in 2D/3D AGP VGA supports professional graphics design, gaming, learning, and business applications.

**NOTE:** Depending on your system configuration, components, and options, your system may not show all of the settings displayed in the following pictures.

To open the Properties dialog box, right-click the desktop and select **Properties**, the **Settings** tab, and then the **Advanced** button.

### General

The **Display** box displays the current font size of the selected monitor. To use a different font size, click the arrow, and then click the font size you want.

The **Compatibility** box allows you to specify when to apply changes to system color settings. **NOTE:** Some programs might not display colors correctly without being restarted after you make changes. To avoid this problem, close the program, change the color settings, and then open the program again.

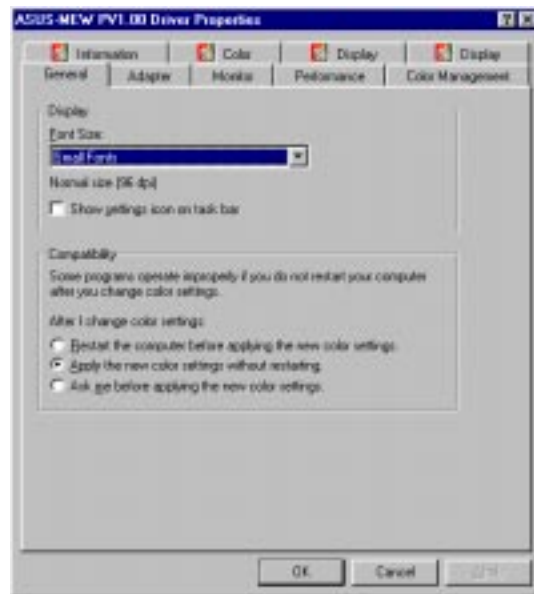

### Adapter

Shows what type of display adapter you are currently using. To install the software for a new display adapter, click **Change**.



# 6. SOFTWARE REFERENCE

## Monitor

Shows what type of monitor you are currently using. To install the software for a new monitor, click **Change**.

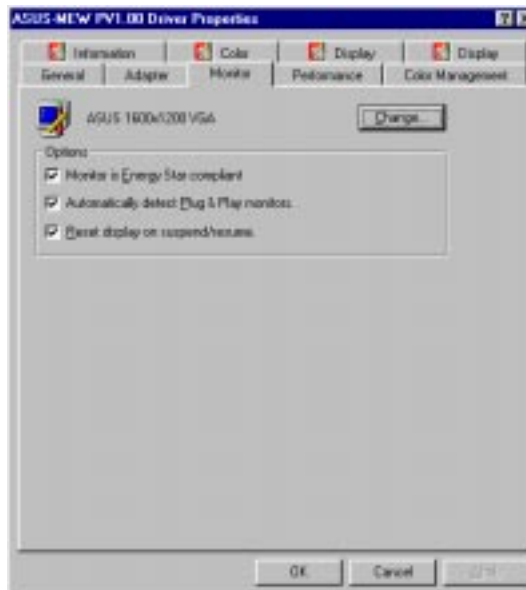

## Performance

Specifies the degree of acceleration you want for your graphics hardware. Full acceleration is the fastest and is recommended for most computers. If your computer is having problems and you suspect graphics acceleration to be the cause, use the highest setting at which you do not have problems.



## Color Management

Lists all the color profile currently associated with your monitor. Click a profile to make it the active profile. Otherwise, the default profile is the active profile.



# 6. SOFTWARE REFERENCE

## Information

Gives information on your graphics device such as chipset, memory, BIOS, and drivers. Internet links are also available for easy access to the ASUS Web page for new updated drivers and notices.



## Color (Desktop)

Allows you to adjust the quality of your display according to your preference. Gamma correction is available only in 16-bit color and 24-bit color (true color, 16.7M-color) modes. In 16-color and 8-bit color (standard color, 256-color) modes, the gamma correction function is not supported.



## Color (Direct3D/Game)

This is the same as the color adjustments for the desktop but this applies to direct3D applications and games.



# 6. SOFTWARE REFERENCE

## Color (Video)

Lets you make color settings for videos.

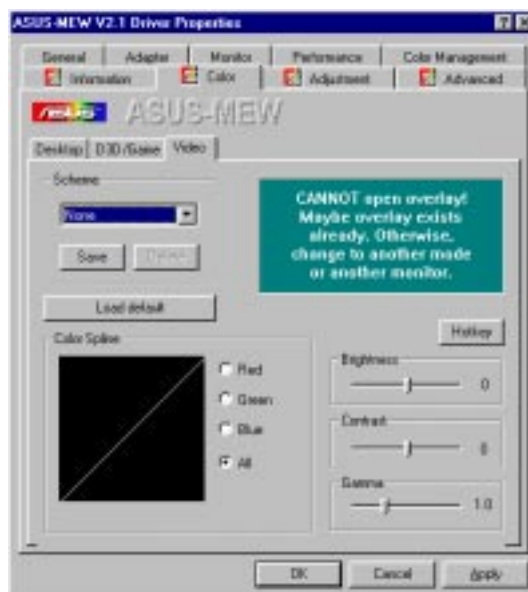

## Adjustment

Allows you to adjust the display position, size, and refresh rate.

### Change refresh rate

Allows you to adjust the default refresh rates for each resolution and color settings.

### Change current refresh rate

Allows you to adjust the currently displayed resolution refresh rate.

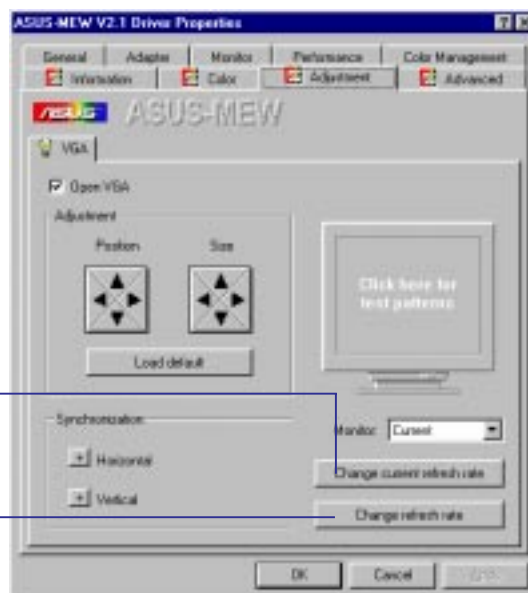

## Advanced

Allows you to assign hot keys to enable the **OnScreen Display (OSD)**. To use this function, select **Enable OSD**. You may want to change the default hot key (CTRL+ALT+O) if it conflicts with the hot keys of other games, video players, or Windows programs.



# 6. SOFTWARE REFERENCE

## 6.2 ASUS PC Probe

ASUS PC Probe is a convenient utility to continuously monitor your computer system's vital components, such as fan rotations, Voltages, and temperatures. It also has a utility that lets you review useful information about your computer, such as hard disk space, memory usage, and CPU type, CPU speed, and internal/external frequencies through the DMI Explorer.

### 6.2.1 Starting ASUS PC Probe

When ASUS PC Probe starts, a splash screen appears allowing you to select whether or not to show the screen the next time you open PC Probe. To bypass this startup screen, clear the **Show up in next execution** check box.

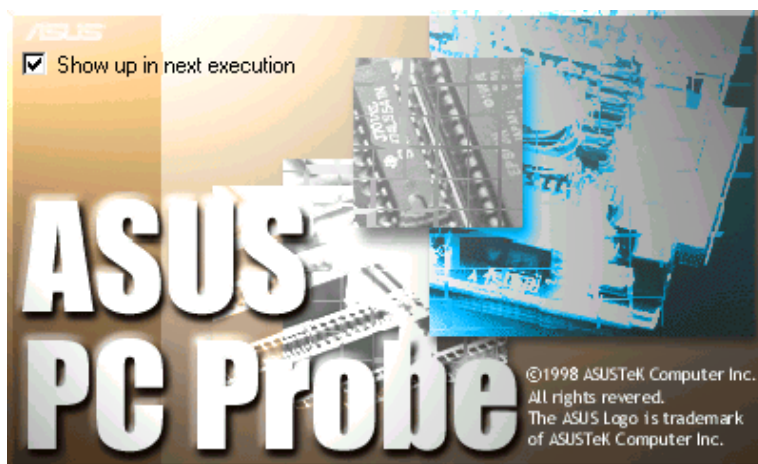

To open **ASUS PC Probe**, click the Windows **Start** button, point to **Programs**, and then **ASUS Utility**, and then click **Probe Vx.xx**.

The PC Probe icon  will appear on the taskbar's system tray indicating that ASUS PC Probe is running. Clicking the icon will allow you to see the status of your PC.

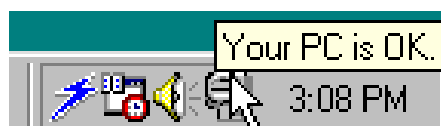

# 6. SOFTWARE REFERENCE

## 6.2.2 Using ASUS PC Probe Monitoring

### Monitor Summary

Shows a summary of the items being monitored.



### Temperature Monitor

Shows the PC's temperature.

Temperature Warning threshold adjustment  
(Move the slider up to increase the threshold level or down to decrease the threshold level)



### Fan Monitor

Shows the PC's fan rotation.

Fan Warning threshold adjustment  
(Move the slider up to increase the threshold level or down to decrease the threshold level)

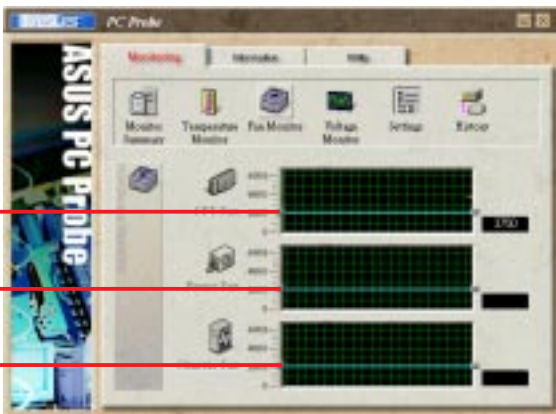

### Voltage Monitor

Shows the PC's voltages.

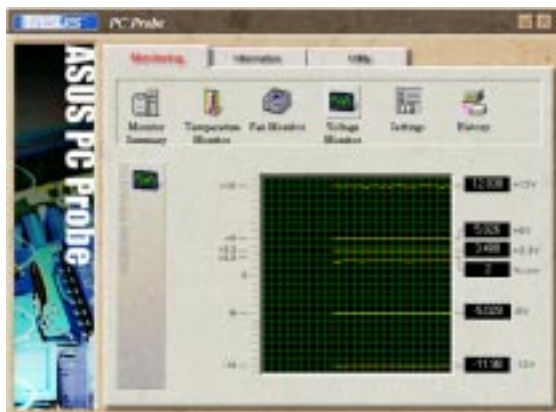



# 6. SOFTWARE REFERENCE

## Settings

Lets you set threshold levels and polling intervals or refresh times of the PC's temperature, fan rotation, and voltages.



## CPU Cooling System Setup

Lets you select when to enable software CPU cooling. When **When CPU Overheated** is selected, the CPU cooling system is enabled whenever the CPU temperature reaches the threshold value.



## History

Lets you record the current monitoring activity of a certain component of your PC for future reference.

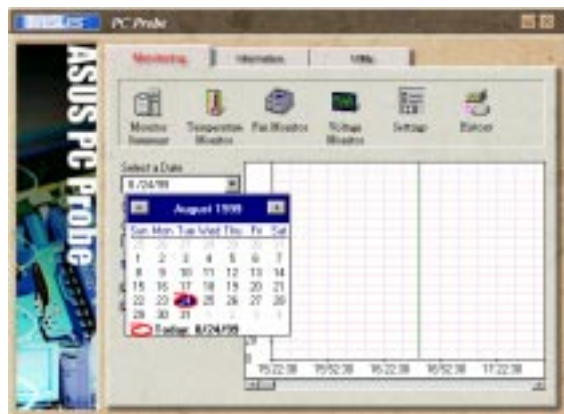

## Information

### Hard Drives

Shows the used and free space of the PC's hard disk drives and the file allocation table or file system used.



# 6. SOFTWARE REFERENCE

## Memory

Shows the PC's memory load, memory usage, and paging file usage.



## Device Summary

Shows a summary of devices in your PC.



## DMI Explorer

Shows information pertinent to the PC, such as CPU type, CPU speed, and internal/external frequencies, and memory size.



## Utility

Lets you run programs outside of the ASUS Probe modules. To run a program, click **Execute Program**.



# 6. SOFTWARE REFERENCE

## 6.2.3 ASUS PC Probe Task Bar Icon

Right-clicking the PC Probe icon will bring up a menu to open or exit ASUS PC Probe and pause or resume all system monitoring.



When the ASUS PC Probe senses a problem with your PC, portions of the ASUS PC Probe icon changes to red, the PC speaker beeps, and the ASUS PC Probe monitor is displayed.

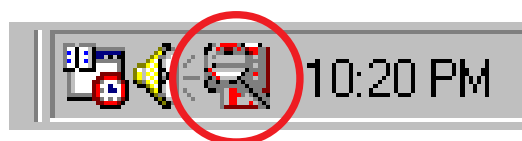

# 6. SOFTWARE REFERENCE

## 6.3 ASUS LiveUpdate

ASUS LiveUpdate is a utility that allows you to update your motherboard's BIOS and drivers. The use of this utility requires that you are properly connected to the Internet through an Internet Service Provider (ISP).

1. Start ASUS Update V2.00.

Launch the utility from **Start | Programs | ASUS Utility | ASUS LiveUpdate V1.00**.

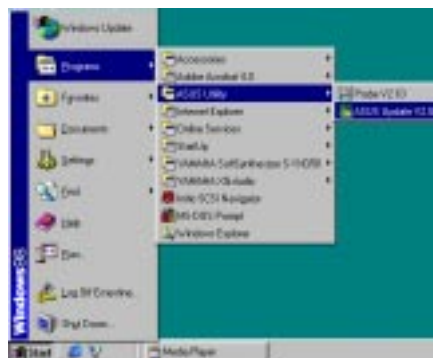

2. Select an update method.



3. If you selected updating/downloading from the Internet, you will need to select an Internet site. Choose the site that is closest to you or click **Auto Select**.



If you selected **Update from a file**, you will be prompted to locate the file.



## 6. SOFTWARE REFERENCE

### 6.4 Using Yamaha XGstudio Player

To start the Yamaha XGstudio, click **Start**, point to **Programs**, point to **YAMAHA XGstudio**, and then click **XGstudio Player**.

#### 6.4.1 Yamaha XGstudio Player Control Panel



Closes the player. **NOTE:** You can also close the player by pressing <Alt>+<F4>.



Minimizes the player to an icon.



Displays the *Set Play List* dialog box where you can create a list of songs to play automatically. **NOTE:** You can also display the *Set Play List* dialog box by pressing <Ctrl>+<O>.



Loads and plays the MIDO file currently selected in *Play List*. When all the songs in the *Play List* have finished, playing stops automatically and the song at the beginning of the list is designated as the current-play song.



Pauses the playing of a song. Click this button again or click  to resume playing.



Stops the playing of a song and returns the start-play location to the beginning of the song.



Designates the first song in the *Play List* as the new current-play song.



Designates the song just before the currently playing song as the new current-play song.



Designates the song after the song currently playing as the new current-play song.



Designates the last song in the *Play List* as the new current-play song.



Displays the control panel for the Soft Synthesizer features.



Speeds up the tempo of the song being played.



Slows down the tempo of the song being played.

**NOTE:** The tempo is reset to 0 for each new song.



Displays the *Set Sound Source* dialog box.



Displays Help. **NOTE:** You can also display Help by pressing <F1>.



Increases/decreases the volume level of the song being played by dragging the slider up/down.

**For detailed instructions and references to software and utilities, use the programs' online help and electronic documentations.**

## 6. SOFTWARE REFERENCE

### 6.5 Using Yamaha XGstudio Mixer

To start the Yamaha XGstudio, click **Start**, point to **Programs**, point to **YAMAHA XGstudio**, and then click **XGstudio Mixer**.

#### 6.5.1 Yamaha XGstudio Mixer Control Panel

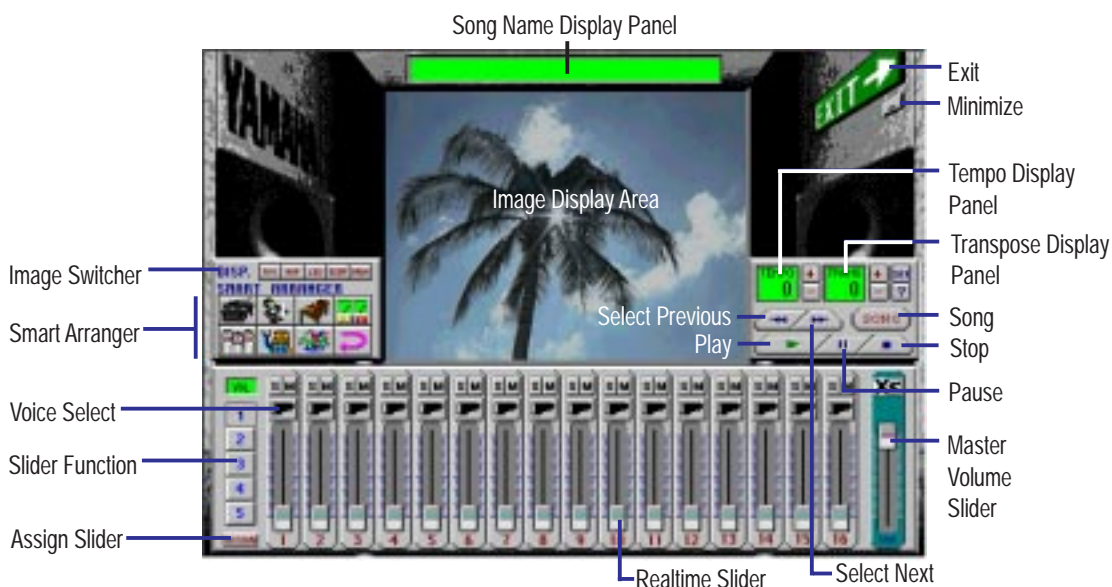



#### Image Switcher

- AVI** (AVI file): **Video image**  
Displays the AVI file with the same name as the MIDI file being played. If one is not available, the preset **DEFAULT.AVI** file is played.
- BMP** (BMP file): **Still image**  
Displays the BMP file with the same name as the MIDI file being played. If one is not available, the preset **DEFAULT.BMP** file is played.
- LED** (LED velocity meter): **Animation**  
Displays the volume (amount of velocity) of each MIDI channel.
- SCOP** (SCOPE velocity meter): **Animation**  
Displays the volume (amount of velocity) of each MIDI channel graphically in a radio chart.
- DRUM** (drum and percussion): **Animation**  
Displays animation with lights that match the drums and percussion used in the drum channel (10ch).

# 6. SOFTWARE REFERENCE

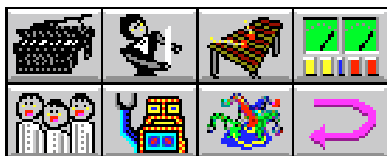
## Smart Arranger



The Smart Arranger allows you to easily change the mood of a song. You can switch between seven ensemble voice sets with these buttons. To return to the original voice set, click .



Piano



Orchestra



Mallet

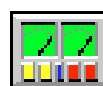

Techno



Choir



Robot



Nature



Return

# 6. SOFTWARE REFERENCE

## 6.6 Hardware Information

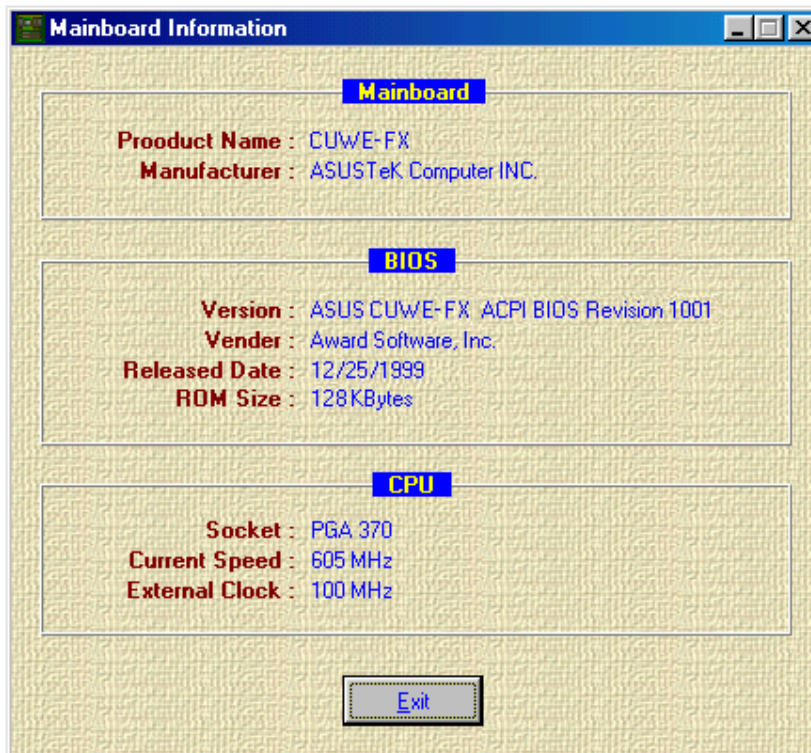



# 7. APPENDIX

## 7.1 ASUS LCD-I Controller Module

The ASUS LCD-I controller module allows you to connect a digital flat panel to your PC. This controller module transmits sharp, bright images by eliminating digital-to-analog and analog-to-digital conversions, which can accumulate noise and degrade image quality.

### 7.1.1 Installation Procedure

1. You must have an ASUS motherboard with a pair of LCD-TV headers.
2. Align the LCD-I module's **LCDTV0** and **LCDTV1** connectors over the motherboard's LCD-TV headers, and press firmly.
3. Connect the digital LCD cable from the LCD and serial combination bracket to the **DFP** connector on the LCD-I module.
4. Secure the bracket to the system chassis with a screw.
5. Plug the signal cable of your digital flat panel into the DFP connector on the bracket (as shown below).

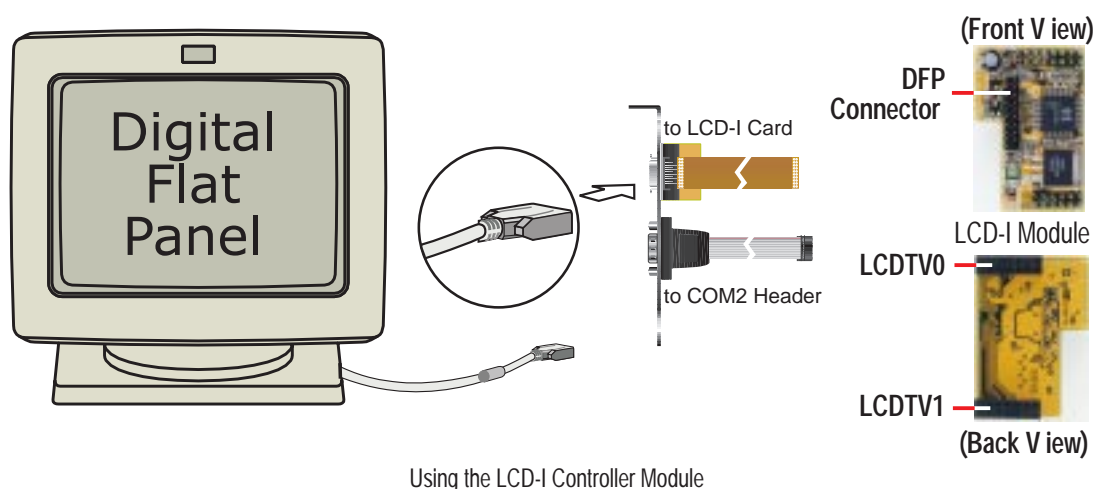

**NOTE:** The LCD-I controller module can work with your LCD panel without any driver. However, if you want to have full-screen display, please set up the VGA driver that comes with your motherboard's support CD.

# 7. APPENDIX

---

(This page was intentionally left blank.)

# 7. APPENDIX

## 7.2 Modem Riser

### 7.2.1 56K Software Modem

The Modem Riser (MR) is a high-speed PC communication peripheral which works with AMC'97/MC'97 compliant codecs. With this software modem, you can connect your computer to a remote location, receiving data at up to 56 Kbps in V.90 or K56flex modes.

### 7.2.2 Primary/Secondary MR

There are two types of modem risers: primary MR and secondary MR. In appearance, the primary MR has a crystal onboard but the secondary does not. If your motherboard has an audio codec and no PCI audio chipset onboard, you may use the secondary MR; otherwise, you should use the primary MR.

*Layout of Primary MR*

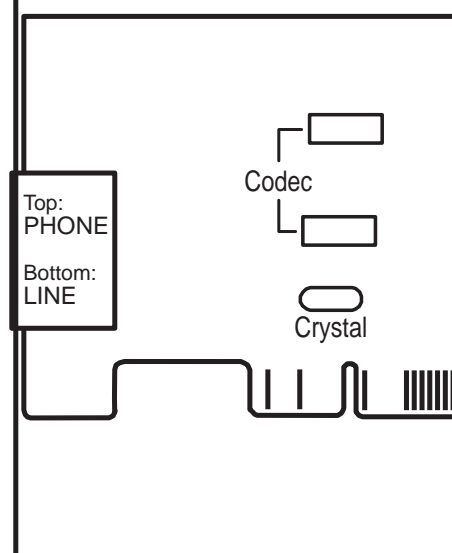

### 7.2.3 Hardware Installation Procedure



1. Power OFF your computer.
2. Open the computer chassis and remove the metal plate on the AMR expansion slot.
3. Carefully align the MR card's connector to the AMR slot and press firmly.
4. Secure the MR card onto the chassis with the screw removed in step 2.
5. Connect the MR card's **LINE** connector to a telephone wall jack. Connect the **PHONE** connector to a telephone (optional).
6. Replace the computer chassis.

# 7. APPENDIX

## 7.2.4 Software Setup in Windows 98

The Modem Riser supports the Plug and Play feature. It allows your computer to automatically set the optimal configurations for the MR and communication software. Follow the procedure below to install the modem driver.

1. Power ON the computer after the hardware installation is completed.
2. Windows 98 will automatically detect the modem and display a "PCI Card" message under "Add New Hardware Found".
3. Select **Search for the best driver for your device** and click **Next**.
4. Insert the Support CD that came with your motherboard into your CD-ROM drive. Enter the path **E:\Modem\Win98** (assuming that your CD-ROM drive is drive E:) for the MR driver.
5. After the driver is located, click **Next** and then click **Finish**.
6. Restart your computer. Double click the modem icon at the bottom-right corner of the window. 
7. Click the **Settings** tab. Select your country and language. Click **OK**.
8. Click **Start**, point to **Settings**, click **Control Panel**, double click **Modems**, click the **General** tab, and click **Motorola SM56 AC-L Modem**.
9. Click **Diagnostic** and then click the designated COM port as shown.
10. Click **More Info...**. If the computer system successfully communicates with the modem, responses will be displayed as shown.

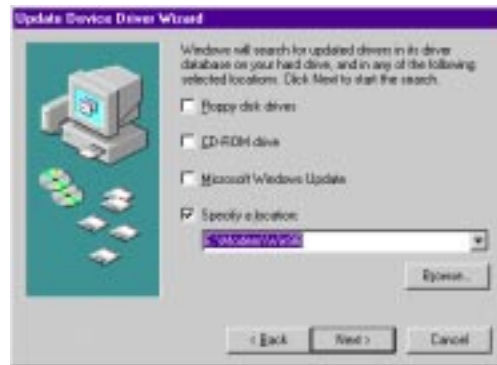

# 7. APPENDIX

## 7.3 Glossary

### 1394

1394 is the IEEE designation for the high performance serial bus at 12.5, 25 or 50MBytes/sec speeds. This serial bus defines both a back plane physical layer and a point-to-point cable-connected virtual bus. The primary application of the cable version is the integration of I/O connectivity at the back panel of personal computers using a low-cost, scalable, high-speed serial interface. The 1394 standard also provides new services such as live connect/disconnect capability for external devices including disk drives, printers and hand-held peripherals such as scanners and cameras. This is a new standard to complement the slower USB interface and to compete with the more expensive SCSI interface.

### AC97 (Audio Codec '97)

AC '97 is the next step in enabling PCs with audio quality comparable to consumer electronics devices. The specification defines new cost-effective options to help integrate the components necessary to support next-generation auto-intensive PC applications such as DVD, 3-D multiplayer gaming and interactive music. The specification also defines new extensions supporting modem and docking to help both desktop and mobile manufacturers adopt these new technologies more quickly and cost-effectively. This specification uses software emulation to compete with the PCI SoundBlaster specification.

### ACPI (Advanced Configuration and Power Interface)

The ACPI specification defines a cross-platform interface designed to support many operating systems. ACPI defines a flexible and abstract hardware interface that provides a standard way to integrate power management features throughout a PC system, including hardware, operating system and application software. This enables the system to automatically turn ON and OFF peripherals such as CD-ROMs, network cards, hard disk drives, and printers, as well as consumer devices connected to the PC such as VCRs, TVs, phones, and stereos. With this technology, peripherals will also be able to activate the PC. For example, inserting a tape into a VCR can turn on the PC, which could then activate a large-screen TV and high-fidelity sound system.

### AGP (Accelerated Graphics Port)

An interface specification that enables high-performance 3D graphics on mainstream PCs. AGP was designed to offer the necessary bandwidth and latency to perform texture mapping directly from system memory.

| Bus    | Bus Frequency | Bandwidth | Data Transfer Rate |
|--------|---------------|-----------|--------------------|
| PCI    | 33MHz         | 33MHz     | 133MByte/sec       |
| AGP 1X | 66MHz         | 66MHz     | 266MByte/sec       |
| AGP 2X | 66MHz         | 133MHz    | 512MByte/sec       |
| AGP 4X | 66MHz         | 266MHz    | 1024MByte/sec      |

### BIOS (Basic Input/Output System)

BIOS is a set of routines that affect how the computer transfers data between computer components, such as memory, disks, and the display adapter. The BIOS instructions are built into the computer's read-only memory. BIOS parameters can be configured by the user through the BIOS Setup program. The BIOS can be updated using the provided utility to copy a new BIOS file into the EEPROM.

### Bit (Binary Digit)

Represents the smallest unit of data used by the computer. A bit can have one of two values: 0 or 1.

# 7. APPENDIX

## **Boot**

Boot means to start the computer operating system by loading it into system memory. When the manual instructs you to “boot” your system (or computer), it means to turn ON your computer. “Reboot” means to restart your computer. When using Windows 95 or later, selecting “Restart” from “Start | Shut Down...” will reboot your computer.

## **Bus Master IDE**

PIO (Programmable I/O) IDE requires that the CPU be involved in IDE access and waiting for mechanical events. Bus master IDE transfers data to/from the memory without interrupting the CPU. Bus master IDE driver and bus master IDE hard disk drives are required to support bus master IDE mode.

## **Byte (Binary Term)**

One byte is a group of eight contiguous bits. A byte is used to represent a single alphanumeric character, punctuation mark, or other symbol.

## **COM Port**

COM is a logical device name used by to designate the computer serial ports. Pointing devices, modems, and infrared modules can be connected to COM ports. Each COM port is configured to use a different IRQ and address assignment.

## **Concurrent PCI**

Concurrent PCI maximizes system performance with simultaneous CPU, PCI and ISA bus activities. It includes multi-transaction timing, enhanced write performance, a passive release mechanism and support for PCI 2.1 compliant delayed transactions. Concurrent PCI provides increased bandwidth, reduced system latencies, improves video and audio performance, and improves processing of host based applications.

## **CPU (Central Processing Unit)**

The CPU, sometimes called “Processor,” actually functions as the “brain” of the computer. It interprets and executes program commands and processes data stored in memory. Currently, there are socket 370 (for Pentium Celeron-PPGA), socket 7 (for Pentium, AMD, Cyrix, IBM), slot 1 (for Pentium II and III), slot 2 (for Xeon), and slot A (for AMD) processors.

## **Device Driver**

A device driver is a special set of instructions that allows the computer’s operating system to communicate with devices such as VGA, audio, printer, or modem.

## **DOS (Disk Operating System)**

DOS is the foundation on which all other programs and software applications operate, including Windows. DOS is responsible for allocating system resources such as memory, CPU time, disk space, and access to peripheral devices. For this reason, DOS constitutes the basic interface between you and your computer.

## **DRAM (Dynamic Random Access Memory)**

There are several different types of DRAM such as, EDO DRAM (Extended Data Output DRAM) and SDRAM (Synchronous DRAM).

## **Flash ROM**

The flash ROM is designed to be a resident program and can be updated by a specific programming method. Normally, the flash ROM is used for system BIOS which initiates hardware devices and sets up necessary parameters for the OS. Since the contents of flash ROM can be modified, users are able to update the BIOS by themselves.

## **IDE (Integrated Drive Electronics)**

IDE devices integrate the drive control circuitry directly on the drive itself, eliminating the need for a separate adapter card (in the case for SCSI devices). UltraDMA/33 IDE devices can achieve up to 33MB/Sec transfer.

# 7. APPENDIX

---

## **LPT Port (Line Printer Port)**

Logical device name reserved by DOS for the computer parallel ports. Each LPT port is configured to use a different IRQ and address assignment.

## **MMX**

A set of 57 new instructions based on a technique called Single Instruction, Multiple Data (SIMD), which is built into the new Intel Pentium PP/MT (P55C) and Pentium II (Klamath) CPU as well as other x86-compatible microprocessors. The MMX instructions are designed to accelerate multimedia and communications applications, such as 3D video, 3D sound, video conference.

## **OnNow**

The OnNow design initiative is a comprehensive, system-wide approach to system and device power control. OnNow is a term for PC that is always ON but appears OFF and responds immediately to user or other requests. The OnNow design initiative involves changes that will occur in the Microsoft Windows operating system, device drivers, hardware, and applications, and also relies on the changes defined in the Advanced Configuration and Power Interface (ACPI) specification.

## **PC100**

SDRAM is Intel's goal is to ensure that memory subsystems continue to support evolving platform requirements and to assure that memory does not become a bottleneck to system performance. It is especially important to ensure that the PC memory roadmap evolves together with the performance roadmaps for the processors, I/O and graphics.

## **PCI Bus (Peripheral Component Interconnect Local Bus)**

PCI bus is a specification that defines a 32-bit data bus interface. PCI is a standard widely used by expansion card manufacturers.

## **PCI Bus Master**

The PCI Bus Master can perform data transfer without local CPU help and furthermore, the CPU can be treated as one of the Bus Masters. PCI 2.1 supports concurrent PCI operation to allow the local CPU and bus master to work simultaneously.

## **Plug and Play BIOS**

The ISA bus architecture requires the allocation of memory and I/O address, DMA channels and interrupt levels among multiple ISA cards. However, configuration of ISA cards is typically done with jumpers that change the decode maps for memory and I/O space and steer the DMA and interrupt signals to different pins on the bus. Further, system configuration files may need to be updated to reflect these changes. Users typically resolve sharing conflicts by referring to documentation provided by each manufacturer. For the average user, this configuration process can be unreliable and frustrating. Plug and play (PnP) BIOS eliminates the ISA add-on card hardware conflict problem. The PnP BIOS uses a memory block to define and remember each card's configuration, which allows the user to change the card's IRQs and DMA in BIOS either automatically or manually.

## **POST (Power On Self Test)**

When you turn ON the computer, it will first run through the POST, a series of software-controlled diagnostic tests. The POST checks system memory, the motherboard circuitry, the display, the keyboard, the diskette drive, and other I/O devices.

## **PS/2 Port**

PS/2 ports are based on IBM Micro Channel Architecture. This type of architecture transfers data through a 16-bit or 32-bit bus. A PS/2 mouse and/or keyboard may be used on ATX motherboards.

# 7. APPENDIX

---

## **ROM (Read Only Memory)**

ROM is nonvolatile memory used to store permanent programs (called firmware) used in certain computer components. Flash ROM (or EEPROM) can be reprogrammed with new programs (or BIOS).

## **SCSI (Small Computer System Interface)**

High speed multi-threaded I/O interface defined by the X3T9.2 committee of the American National Standards Institute (ANSI) for connecting many peripheral devices. The standard started from 10MBytes/sec to 160MBytes/sec available today.

## **SDRAM (Synchronous DRAM)**

The SDRAM features a fully synchronous operation referenced to a positive edge clock whereby all operations are synchronized at a clock input which enables the coexistence of high performance and a simple user interface. SDRAM takes memory access away from the CPU's control; internal registers in the chips accept the request, and let the CPU do something else while the data requested is assembled for the next time the CPU talks to the memory. As they work on their own clock cycle, the rest of the system can be clocked faster. There is a version optimized for video cards, and main memory for motherboards.

## **SPD for SDRAM module**

Serial Presence Detect (SPD) is most like an ID detect for SDRAM module, it using a EEPROM component on DIMM module for storing module configuration information inside. The Serial Presence Detect function is implemented using a 2048 bit EEPROM component. This nonvolatile storage device contains data programmed by the DIMM manufacturer that identifies the module type and various SDRAM organization and timing parameters.

## **System Disk**

A system disk contains the core file of an operating system and is used to boot up the operating system.

## **UltraDMA**

Ultra DMA/33 is a "synchronous DMA" protocol designed by Intel. This function is included into Intel's PIIX4 chipset. The traditional IDE transfer only uses one edge of the data stroke as the data transfer. Ultra DMA/33 uses both edges of data strobe when the data is transferred. Hence, the data transfer rate is double of the PIO mode 4 or DMA mode 2 (16.6MB/s x2 = 33MB/s) on ATA-2 devices.

Ultra ATA/66, also known as Ultra DMA/66, is an extension of current Ultra ATA/33 interface. This new high-speed interface has doubled the Ultra ATA/33 burst data transfer rate to 66.6 Mbytes/sec and maximized disk performance under current PCI local bus environment

## **USB (Universal Serial Bus)**

A 4-pin serial cable bus that allows up to 127 plug and play computer peripherals such as keyboard, mouse, joystick, scanner, printer, modem, and monitor to share a bandwidth through a host scheduled token based protocol. This allows attaching or detaching while the host and other peripherals are in operation. Supports synchronous and asynchronous transfer types over the same set of wires up to 12Mbit/sec. USB 2.0 provides twice the transfer rate compared to USB 1.0 and competes with the 1394 standard.

## **Wake-On-Lan**

Computer will automatically wake-up upon receiving a wake-up packet through a Network interface when it is under power soft-off, suspend or sleep mode.



# INDEX

---

## A

- AC PWR Loss Restart 71
- Adobe Acrobat Reader 97
- ASUS LiveUpdate 88
  - Setup 88
  - Using 108
- ASUS PC Probe
  - Setup 87
  - Using 103
- ATAPI CD-ROM 74
- ATX Power Supply Connector 39
- Audio Controller 63
- Audio, PCI 9
- Audio Port Connectors 31
- Automatic Power Up 72
- Automatic Timeout Reboot Setting 19

## B

- BIOS Beep Codes 41
- BIOS Update 57
- Boot Sequence 74
- Boot Up Floppy Seek 75
- Boot Up NumLock Status 54
- Boot Virus Detection 75

## C

- Central Processing Unit 24
- Chassis Fan Speed 73
- Chassis Intrusion Lead 38
- CHS Capacity 52
- Connectors
  - ATX Power Supply 39
  - Audio Port 31
  - Consumer IR 35
  - Fan 34
  - Fast-Ethernet Port 31
  - Floppy Disk Drive 32
  - Internal Audio 37
  - Internal Microphone 36
  - Internal Speaker 38
  - Joystick/MIDI 31
  - Monitor Output 31
  - Parallel Port 30
  - Power Supply Thermal Sensor 39

- Primary IDE 32
- PS/2 Keyboard 29
- PS/2 Mouse 29
- Secondary IDE 32
- Serial Port COM1 30
- SMBus 36
- Standard IR 35
- USB 30
- Wake-On-LAN 33
- Wake-On-Ring 33
- Consumer IR Connector 35
- CPU
  - Type 55
- CPU Bus Frequency (MHz) 56
- CPU Fan Speed 73
- CPU Latency Timer 61
- CPU Level 1 Cache 57
- CPU Level 2 Cache 57
- CPU Level 2 Cache ECC Check 57
- CPU Speed 56
- CPU Temperature 73
- CPU Type 55
- CPU Vcore 56
- CPU/SDRAM/HL/PCI Freq. Rati 56
- Cylinders 51

## D

- D0000-DFFFF Shadow 68
- Digital LCD Headers 36
- Discard Changes 77
- Display Cache 61
- Display Cache CAS Latency 61
- Display Cache Cycle Time (Tras, Trc) 61
- Display Cache Paging Mode 61
- Display Cache RAS Precharge Time 61
- Display Cache RAS to CAS Delay 61
- Display Cache Window Size 61
- DMA x Used By ISA 67
- Driver Setup 89, 90
  - Intel Security 93
  - PCI Audio 81

## E

- ECP DMA Select 64
- Exit Discarding Changes 76

# INDEX

---

Exit Saving Changes 76  
Expansion Cards 25  
    Assigning IRQs 26  
    Audio Modem Riser 28  
    Installation Procedure 25

## F

Fan Connectors 34  
Fast-Ethernet Port Connector 31  
Floppy 3 Mode Support 49  
Floppy Disk Access Control 63  
Floppy Disk Drive Connector 32  
Full Screen Logo 75

## H

Halt On 55  
Hardware Information 112  
Hardware Setup 17  
    CPU Installation 24  
    Memory Installation 23  
HDD Power Down 70  
Head 52  
Headers  
    Digital LCD 36  
    Serial Port COM 2 35  
High Priority PCI Mode 62

## I

IDE Activity LED Lead 34  
IDE Hard Drive 74  
INF Update Utility for 810 Chipset  
    89, 90  
Installation  
    CPU 24  
    Expansion Card 25  
    Memory 23  
Installed Memory 55  
Intel Security Driver 93  
Internal Audio Connectors 37  
Internal Microphone Connector 36  
Internal Speaker Connector 38  
Interrupts  
    Request Table 27  
    Standard Assignments 26  
IRQ XX Used By ISA 66

ISA MEM Block BASE 68  
Item Checklist 7

## J

Joystick/MIDI Connector 31

## K

Keyboard Auto-Repeat Delay 54  
Keyboard Auto-Repeat Rate 54  
Keyboard Features 54

## L

Language 55  
Layout Contents 15  
LDCM Administrator Setup 84  
LDCM Client Setup 82  
Leads  
    Chassis Intrusion 38  
Legacy Diskette A 49  
Legacy Diskette B 49  
LiveUpdate  
    Setup 88  
    Using 108  
Load Setup Defaults 77

## M

Maximum LBA Capacity 52  
MB Temperature 73  
Memory Hole At 15M-16M 61  
Memory Installation 23  
Monitor Output Connector 31  
Motherboard  
    Layout 14  
    Settings 17  
Multi-Sector Transfers 52

## O

ONB VGA BIOS First 66  
Onboard AC97 Modem Controller 63  
Onboard Audio Codec Setting 18  
Onboard CIR I/O 64  
Onboard CIR IRQ 64

# INDEX

---

Onboard FDC Swap A & B 63  
Onboard Game Port 64  
Onboard LAN Boot ROM 66  
Onboard MIDI I/O 64  
Onboard MIDI IRQ 64  
Onboard Parallel Port 64  
Onboard PCI IDE Enable 62  
Onboard Serial Port 1 63  
Onboard Serial Port 2 63  
Onboard VGA 61  
Operating Systems 79  
OS/2 Onboard Memory > 64M 57  
Other Boot Device Select 74

## P

Parallel Port Connector 30  
Parallel Port Mode 64  
PC Probe  
    Setup 87  
    Using 103  
PC-cillin 98 Setup 95  
PCI 3 Volt Setting 18  
PCI Audio 9  
PCI Latency Timer 65  
PCI/VGA Palette Snoop 65  
PIO Mode 52  
Plug & Play O/S 75  
Power Fan Speed 73  
Power Management 69  
Primary IDE Connector 32  
Procedure  
    CPU Installation 24  
    Hardware Setup 17  
Procedures  
    Updating BIOS 44  
Programs  
    Uninstalling 96  
PS/2 Keyboard Connector 29  
PS/2 Mouse Connector 29  
PS/2 Mouse Function Control 57  
PWR Button < 4 Secs 70  
PWR Up On Modem Act 71

## Q

Quick Power On Self Test 75

## R

Removable Device 74

## S

Safe Mode Setting 19, 20, 21  
Save Changes 77  
SDRAM CAS Latency 60  
SDRAM Configuration 60  
SDRAM Cycle Time (Tras, Trc) 60  
SDRAM RAS Precharge Time 61  
SDRAM RAS to CAS Delay 60  
Secondary IDE Connector 32  
Sector 52  
Serial Port COM 2 Header 35  
Serial Port COM1 Connector 30  
Setting  
    Onboard Audio Codec 18  
    Safe Mode 19, 20, 21  
Settings  
    Automatic Timeout Reboot 19  
    I/O Voltage 18  
    Motherboard 17  
    Onboard Audio 18  
    PCI 3 Volt 18  
    Safe Mode 19, 20, 21  
Setup  
    Hardware 17  
SMART Monitoring 52  
SMBus Connector 36  
Software Setup  
    Adobe Acrobat Reader 97  
    LDCM Administrator 84  
    LDCM Client 82  
    LiveUpdate 88  
    PC Probe 87  
    PC-cillin 98 95  
    Yamaha S-YXG50 92  
    Yamaha XGStudio 94  
Specifications 8  
Standard IR Connector 35  
Starting Up 41

# INDEX

---

Supervisor Password 55  
Support CD  
    Main Menu 81  
    Navigation Button 81  
Suspend Mode 70  
Suspend-to-RAM  
    Support 10  
Suspend-to-RAM Capability 70  
SYMBIOS SCSI BIOS 65  
System Date 49  
System Memory 22  
System Time 49

## T

Thermal Sensor Connector 39  
Translation Method 51  
Type 50

## U

UART2 Use Standard Infrared 64  
Ultra DMA Mode 52  
Uninstalling Programs 96  
Universal Serial Bus Ports 30  
Updating Your BIOS 43  
USB Function 66  
USB Legacy Support 57  
User Password 55  
Using  
    LiveUpdate 108  
    PC Probe 103  
    Yamaha XGstudio Mixer 110  
    Yamaha XGstudio Player 109

## V

VCORE Voltage 73  
Video Off Method 70  
Video Off Option 70  
Video ROM BIOS Shadow 68  
Voltage  
    +12 73  
    +3.3 73  
    +5 73  
    -12 73  
    -5 73  
VCORE 73

## W

Wake On LAN 71  
Wake On PS2 KB/PS2 Mouse/CIR 72  
Wake Up By Keyboard 72  
Wake-On-LAN Connector 33  
Wake-On-Ring Connector 33

## Y

Yamaha S-YXG50 92  
Yamaha XGStudio 94  
Yamaha XGstudio Mixer 110  
Yamaha XGstudio Player 109

# ASUS<sup>®</sup>

# Goes Mobile!

## M8300/8200 Series

*Thin & Light Convertible Notebook PC*

13.3" or 12.1" TFT Color Display  
233/266/300/333/366/400+MHz



## F7400 Series

*Professional Notebook PC*

14.1" TFT Color Display  
300/333/366/400+MHz  
Built-in DVD/MPEG2 Decoder

## L7300/7200 Series

*All-in-One Compact Notebook PC*

13.3" or 12.1" TFT Color Display  
300/333/366/400+MHz



# ASUS® Ultra-Fast CD-ROM



- Supports high speed CD-Audio playback
- Supports high speed digital audio extraction
- Supports UltraDMA/33 transfer mode
- Compatible with all CD formats
- Supports multi-read function (CD-R/CD-RW)



|                       |                                                                                                                                                                                   |
|-----------------------|-----------------------------------------------------------------------------------------------------------------------------------------------------------------------------------|
| Drive Interface Type: | ATAPI/Enhanced IDE supporting PIO mode 4, multi-word DMA mode 2, UltraDMA/33                                                                                                      |
| Disc Formats:         | Audio CD, CD-ROM (mode 1 & mode 2), Mixed mode, CD-ROM/XA (mode 2, form 1 & form 2), Video CD, CD-I, Photo CD (single & multi-session), Karaoke CD, CD Extra, I-Trax, CD-R, CD-RW |
| Disk Size:            | 8 cm and 12 cm                                                                                                                                                                    |
| OS Compatibility:     | DOS 6.xx, Windows 3.x/95/98, OS/2 Warp, Netware, SCO UNIX                                                                                                                         |
| Cache Buffer Size:    | 128KB                                                                                                                                                                             |
| Data Transfer Rate:   | CD-S500 7500 KBps maximum<br>CD-S450 6750 KBps maximum<br>CD-S400 6000 KBps maximum                                                                                               |
| Access Time:          | 75ms                                                                                                                                                                              |

# ASUS® Barebone Servers

|               | Pentium® III<br>Pentium® II<br>Support | PC100 ECC<br>Max. Memory<br>(GB) | Ultra2 SCSI<br>Onboard<br>(Channels) | 5.25"<br>Fixed Storage<br>Devices | Hot-Swap Trays |
|---------------|----------------------------------------|----------------------------------|--------------------------------------|-----------------------------------|----------------|
| <b>AP100</b>  | 1                                      | 1                                | 1                                    | 3                                 | 0              |
| <b>AP200</b>  | 2                                      | 1                                | 1                                    | 3                                 | 0              |
| <b>AP2000</b> | 2                                      | 1                                | 1                                    | 4                                 | 3 or 5*        |
| <b>AP2500</b> | 2                                      | 1                                | 1                                    | 4                                 | 3 or 5*        |
| <b>AP3000</b> | 2 Xeon™                                | 2                                | 2                                    | 4                                 | 3 or 5*        |
| <b>AP6000</b> | 2                                      | 1                                | 1                                    | 4                                 | 8**            |
| <b>AP7500</b> | 2                                      | 1                                | 1                                    | 4                                 | 8**            |
| <b>AP8000</b> | 2 Xeon™                                | 2                                | 2                                    | 4                                 | 8**            |

\* Three 1.6-inch or five 1-inch SCA-2 SCSI hard drives

\*\* Eight 1.6-inch or 1-inch SCSI hard drives

## Mid-Range Servers

AP6000  
AP7500  
AP8000

## Value Servers

AP2000  
AP2500  
AP3000

## Group Servers

AP100  
AP200



Rack Mountable

## ASUS AR1000 RAID Sub-system with DA3000 SCSI-to-SCSI RAID Controller

- Supports 5x86 RAID processor and two 72-pin SIMM sockets for up to 128MB cache memory
- Supports three Ultra2 SCSI channels; up to 80MB/sec data transfer rate
- Supports multiple Host/Drive channel capacity
- Redundant controller capacity
- Supports non-RAID, RAID levels 0, 1, 0+1, 3, 5
- On-line failure drive rebuilding
- Automatic rebuilding — supports local/global spare drive
- On-line expansion capacity
- Supports SAF-TE (SCSI Accessed Fault-Tolerant Enclosure) feature
- Provides LCD panel and RS-232 port to configure RAID
- Ten 1.0" or six 1.6" Ultra2 SCSI SCA-2 hot-swappable drive bays
- 19" rack mountable (height: 5U)
- LED for hard disk power and working status
- Two 8cm system fans and four 6cm drive fans
- Aluminum disk arrays for easy heat dissipation
- 350W redundant power supply

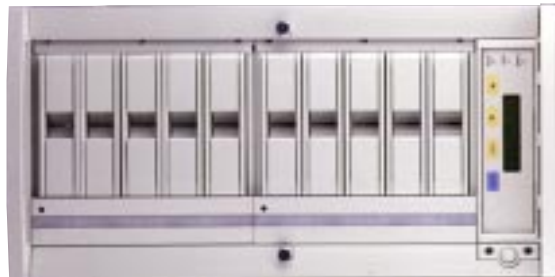

## ASUS PCI-DA2100/2200 Series SCSI RAID Card

- PCI-DA2100 series support 4x86 DX4-100 processor
- PCI-DA2200 series support 5x86-133 processor
- One 72-pin SIMM socket supports up to 128MB cache memory
- RAID levels 0, 0+1, 3, 5, non-RAID
- PCI-DA2100A supports Ultra Wide SCSI interface and dual channels
- PCI-DA2200A supports Ultra2 SCSI interface and single channel
- PCI-DA2200B supports Ultra2 SCSI interface and dual channels
- Automatic bad sector reassignment
- Supports both global and local spare drive operation
- Background rebuilding
- PCI rev. 2.1 compliant
- Up to 8 logical drives and 8 partitions per logical drive; number of drives for each logical drive has no limitation





## Free Manuals Download Website

<http://myh66.com>

<http://usermanuals.us>

<http://www.somanuals.com>

<http://www.4manuals.cc>

<http://www.manual-lib.com>

<http://www.404manual.com>

<http://www.luxmanual.com>

<http://aubethermostatmanual.com>

Golf course search by state

<http://golfingnear.com>

Email search by domain

<http://emailbydomain.com>

Auto manuals search

<http://auto.somanuals.com>

TV manuals search

<http://tv.somanuals.com>