

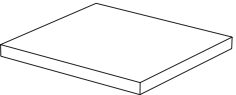

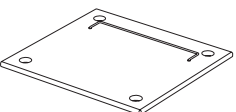

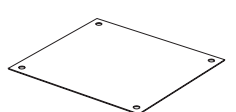
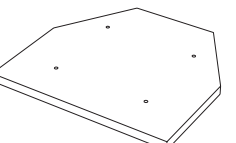

Assembly Instructions:

Directives d'assemblage / Instrucciones / Anleitungen zum Zusammenbau:

QTY Cant. / Qté / Menge	PARTS LIST Lista de Componentes / Liste des pieces / Teilleiste:
2	 A
6	 B
2	 C
2	 D
8	 E
8	 F
8	 (1)
8	 (2)
4	 (3)
1	 (4)

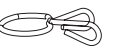
1

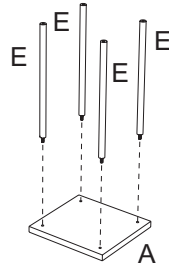

2

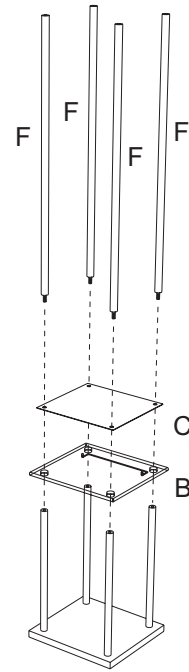

3

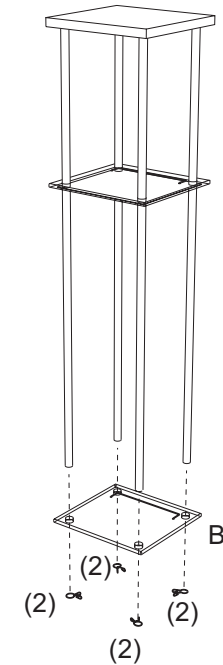

4

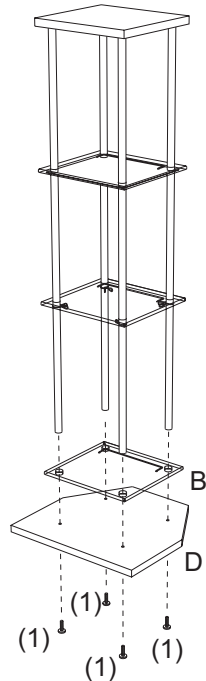

5

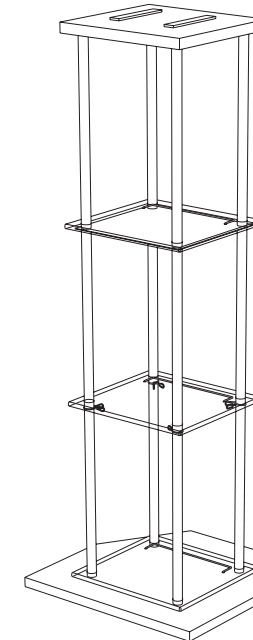
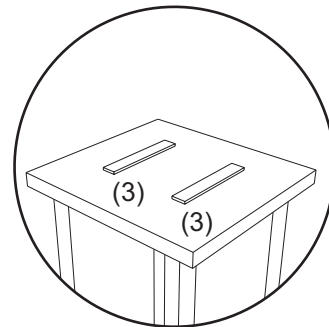
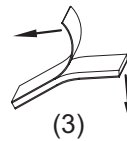

Speaker Stand
Puesto de Bocina
Support pour haut-parleur
Lautsprecherständer

ATLANTIC®

©2005 Atlantic Inc.

Santa Fe Springs, CA, U.S.A.

U.S. AND OTHER FOREIGN PATENTS PENDING

Patentes de los EUA y países extranjeros en trámite

Brevets en cours pour Etats Unis et autres pays étrangers

U.S. und andere ausländische Patente sind hängig

ALL RIGHTS RESERVED

Derechos Reservados / Tous droits réservés /

Alle Rechte vorbehalten

www.atlantic-inc.com

MADE IN CHINA

Hecho en China / Fabriqué en Chine /

Hergestellt in China

R 1.0 050202



Free Manuals Download Website

<http://myh66.com>

<http://usermanuals.us>

<http://www.somanuals.com>

<http://www.4manuals.cc>

<http://www.manual-lib.com>

<http://www.404manual.com>

<http://www.luxmanual.com>

<http://aubethermostatmanual.com>

Golf course search by state

<http://golfingnear.com>

Email search by domain

<http://emailbydomain.com>

Auto manuals search

<http://auto.somanuals.com>

TV manuals search

<http://tv.somanuals.com>