

THIS INSTRUCTION BOOKLET CONTAINS  
**IMPORTANT** SAFETY INFORMATION, PLEASE  
READ AND KEEP FOR FUTURE REFERENCE.

Lot Number: \_\_\_\_\_

Date: \_\_\_\_\_

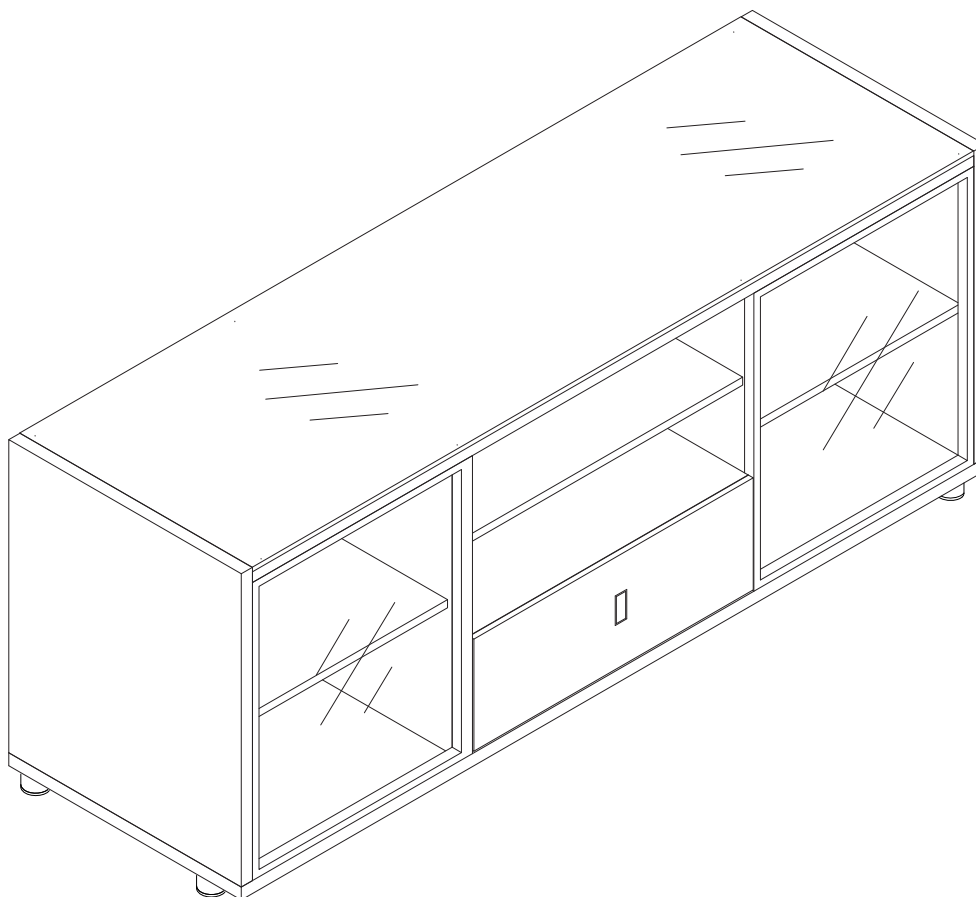

**Item # 36835515**  
**Black Sea TV Cabinet**

Fits PLASMA or LCD TV's that measure 37 to 42 inches. If parts are missing, DO NOT return to the store. To order missing / replacement parts or assembly assistance please call 1-800-747-2660 or mail [customer\\_relations@atlantic-inc.com](mailto:customer_relations@atlantic-inc.com).

## Assembly Tips:

Become familiar with the instructions and all parts.

Make sure that all parts are in the box and in good condition.

Assemble the product on the open flat carton or a rug to protect the product and your floor.

Some heavy products need a second person to assist in the assembly.

Use of power tools is not recommended.

It is strongly recommended that at least two people carry out the assembly.

Assemble the product close to a wall.

With each step, first insert and hand-tighten all bolts and screws by hand. After **ALL BOLTS** are slightly screwed in, fully tighten bolts with Phillips screwdriver in sequential pattern (clockwise or counter clockwise).



### Caution:

Never let children climb on furniture or play with furniture.

Do not sit or stand on furniture.

Do not place a TV that is heavier than the recommended load rating on the furniture surface.

Do not overload shelves.

Use care when moving furniture. Furniture can tip over if moved improperly.

Only move furniture when it is empty of TV or other electronic components.

Handle items with glass with extra care. Use eye and hand protection.

Improper handling can result in cuts and lacerations.











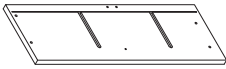
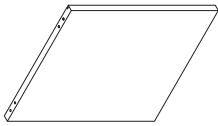

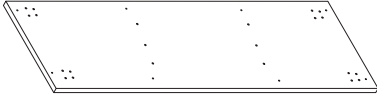

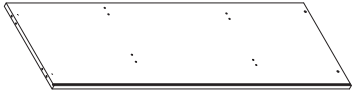

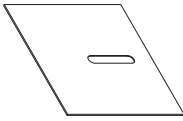
Do not install on sloping surface.



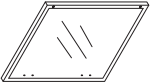

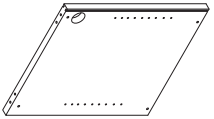
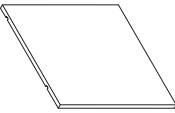
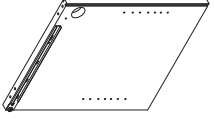

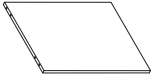
## Care Instructions:

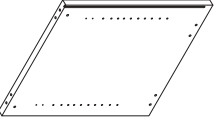

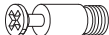
Use electrostatic dust cloths to clean furniture.





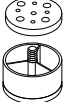
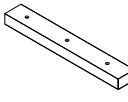

Do not set hot or cold containers directly on the furniture surface.

# Part List

Item	Components parts list	Qty	Item	Components parts list	Qty
A		1	M		1
B		1	N		1
C		1	O		1
D		1	P		1
E		1	Q		2
F		1	R		2
G		1	S		1
H		1	T		2
I		1	U		1
J		1			
K		1			
L		1			

Item	Components parts list	Qty
V1		4
V2		12
V3		12
V4		28
V5		1
V6		4

Item	Components parts list	Qty
V7		4
V8		2
V9		4
V10		8

Item	Components parts list	Qty
V11		8
V12		8
V13		16
V14		10
V15		8
V16		1
V17		8

Tool needed (not included)



## Assembly Instruction

1



V4



V1

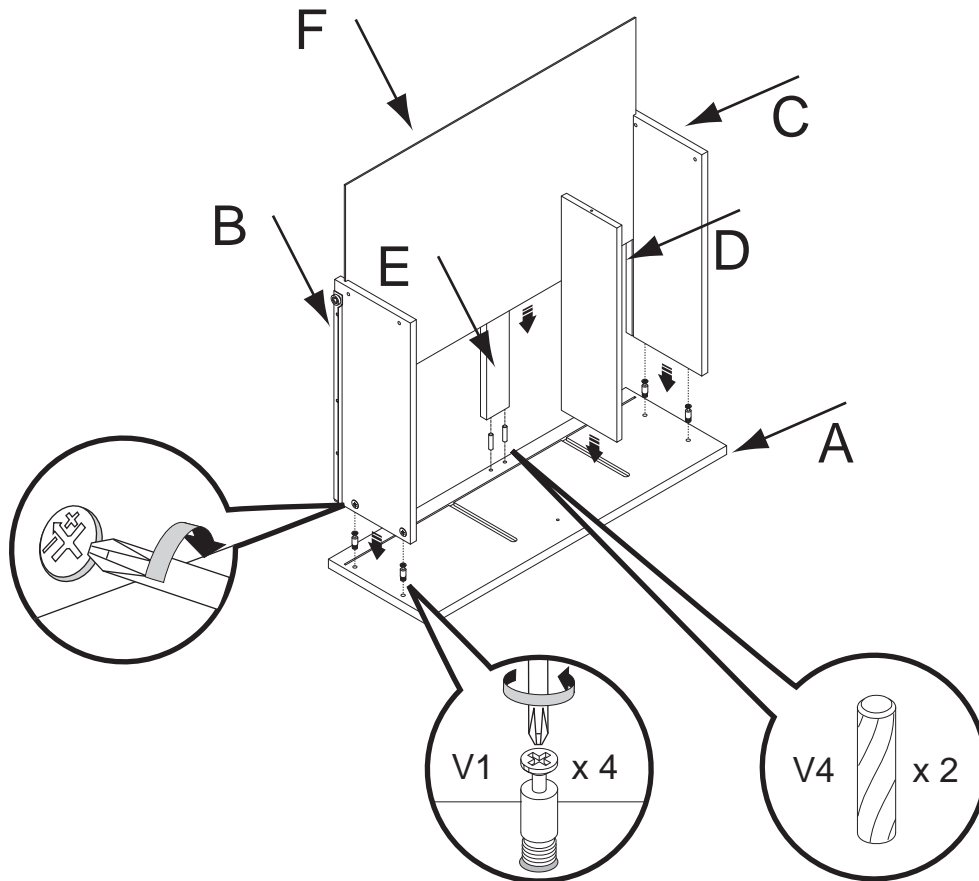

1. Attach board (B,C,D,E,F) to the front board (A) with cam screws (V1) and wooden dowels (V4). Turn the cam locks(on B&C) clockwise to secure.

2



V4

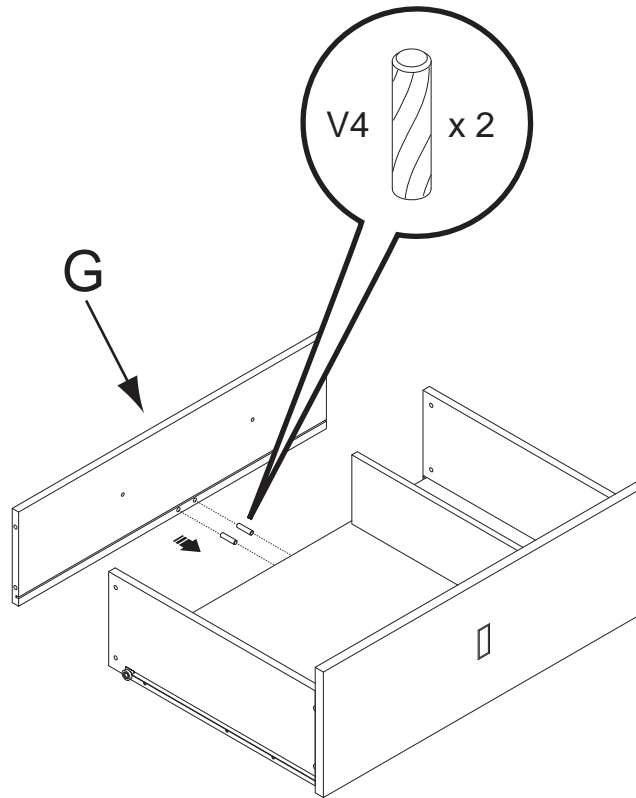

2. Attach back board (G) to the drawer with wooden dowels (V4).

3

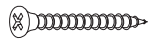

V14



V5

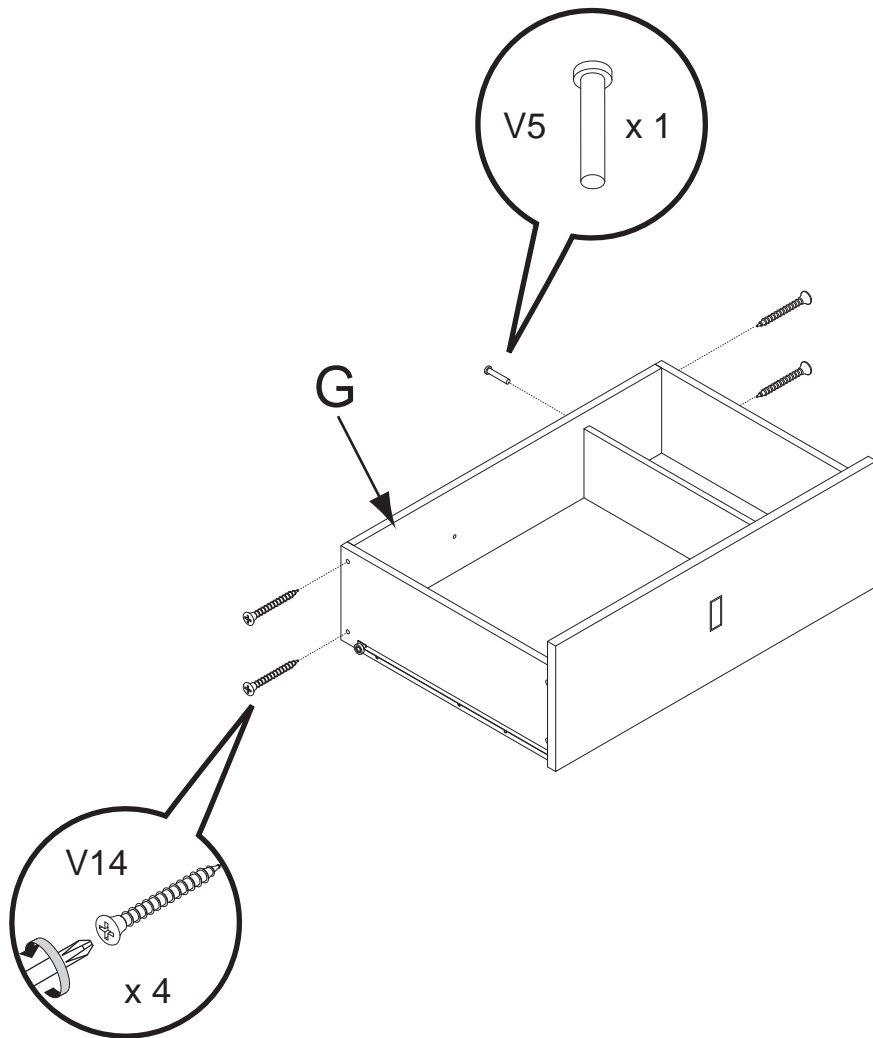

3. Attach back panel (G) to the drawer with screws (V14, V5).

4



V4

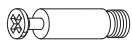

V2



V3

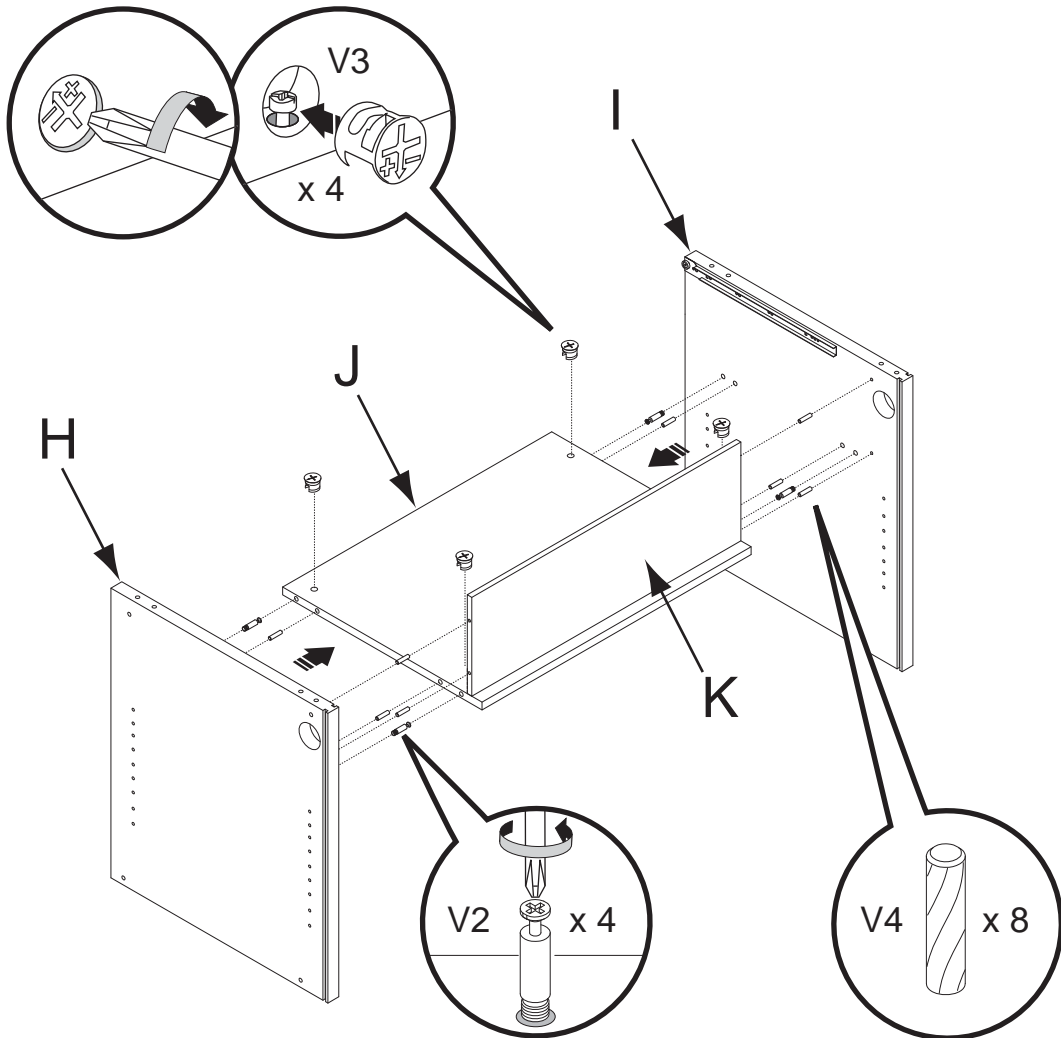

4. Attach Left & Right side board (H,I) to the middle boards (J,K) with screws (V2), cam lock(V3) and wooden dowels (V4),then turn cam lock(V3) clockwise to secure.

5



V4



V2



V3

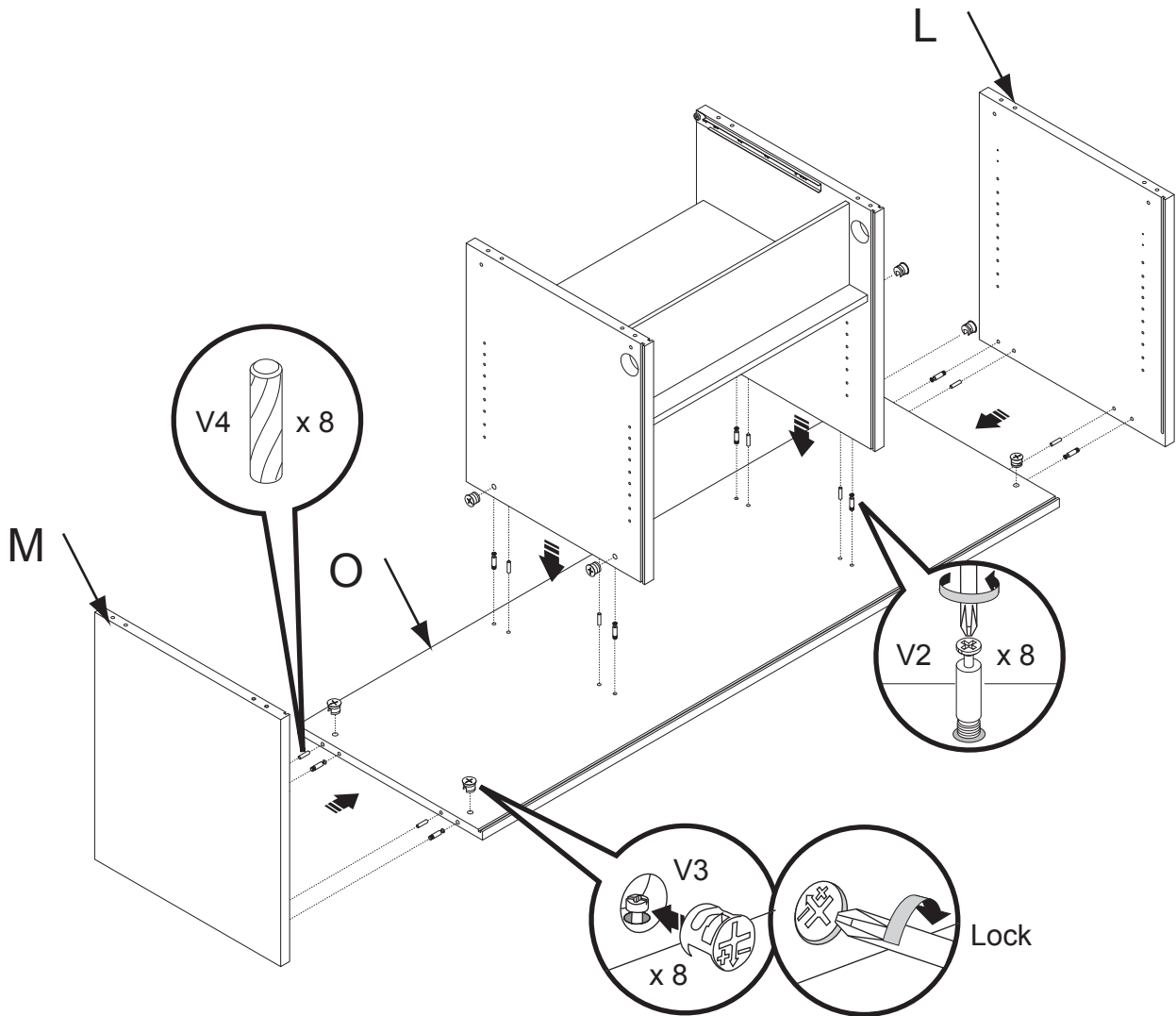

5. Place the assembled center part onto the top board(O) first with screws(V2)and cam lock(V3) . Attach main side board (M & L) to the top board (O) with screws (V2),cam lock(V3) and wooden dowels (V4). Turn the CAM lock(V3) clockwise to secure.



6

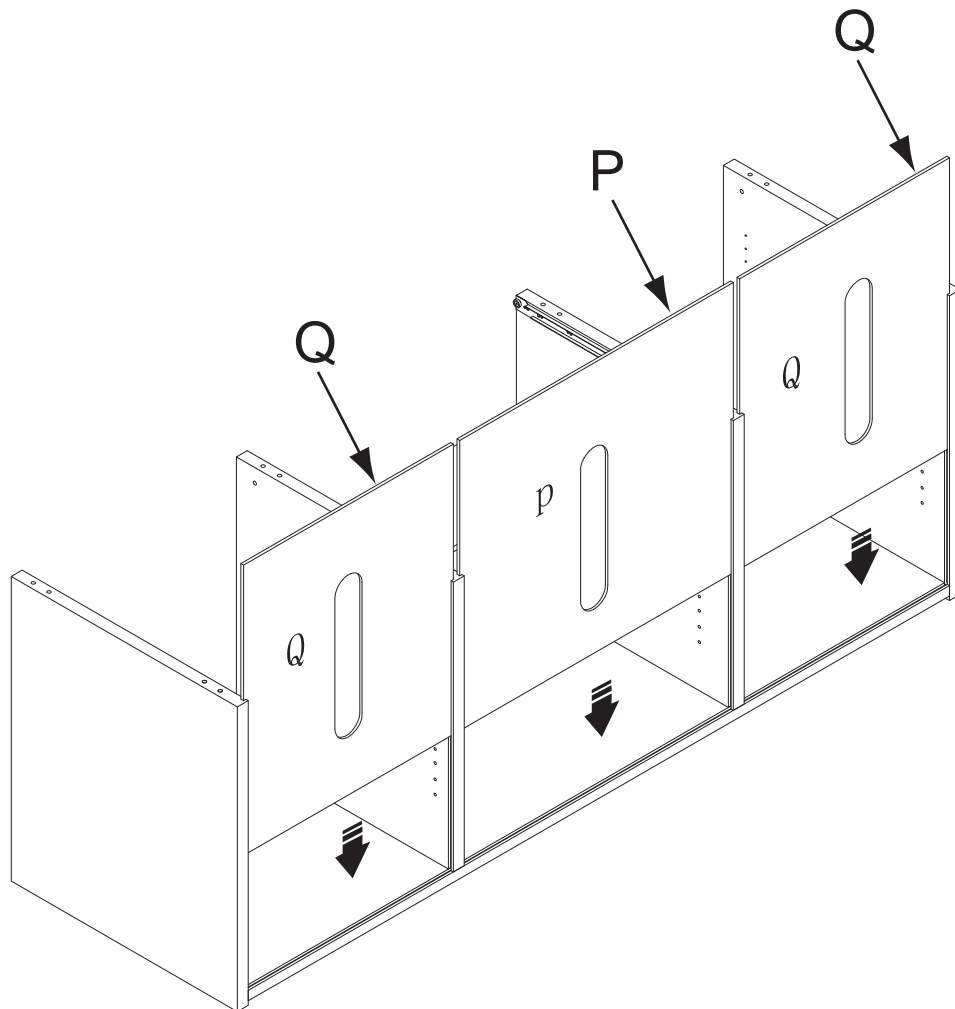

6, Attach thin back, board (Q, P) to the TV cabinet body.

7



V4



V13



V15



V7

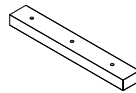

V8

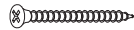

V14

Tools needed:

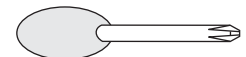

Not included



One set

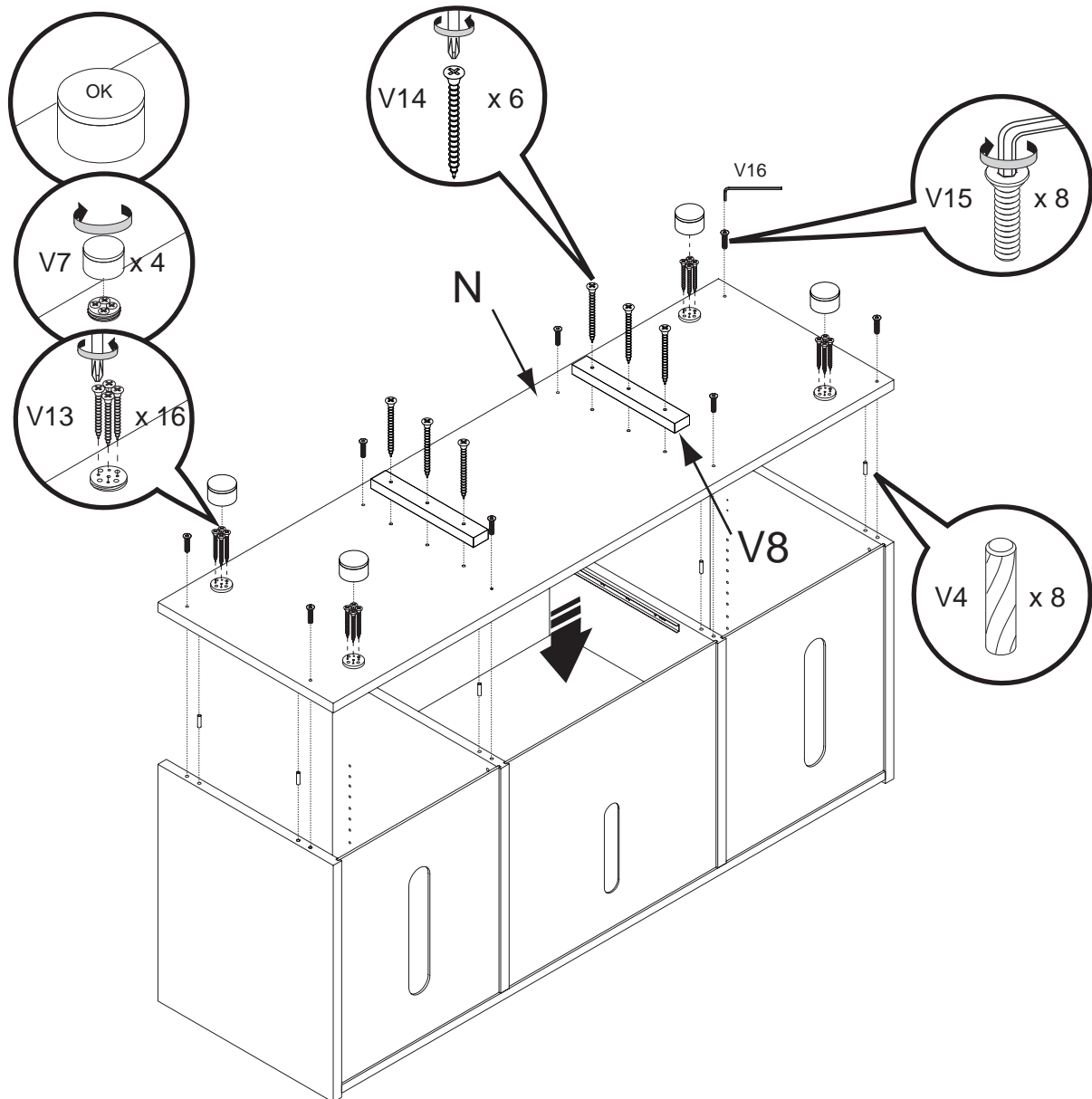

7. Attach bottom board (N) to the TV cabinet body with screws (V15) and wooden dowel (V4). Attach feet (V7) to the bottom board (N) with screws (V13). Attach wood bar (V8) to the bottom board (N) with screws (V14). After the feet are assembled, turn the whole unit over and make it stand upright.  
(NOTE: It is strongly recommended that at least two people carry out this step.)

8



V11



V12



V6

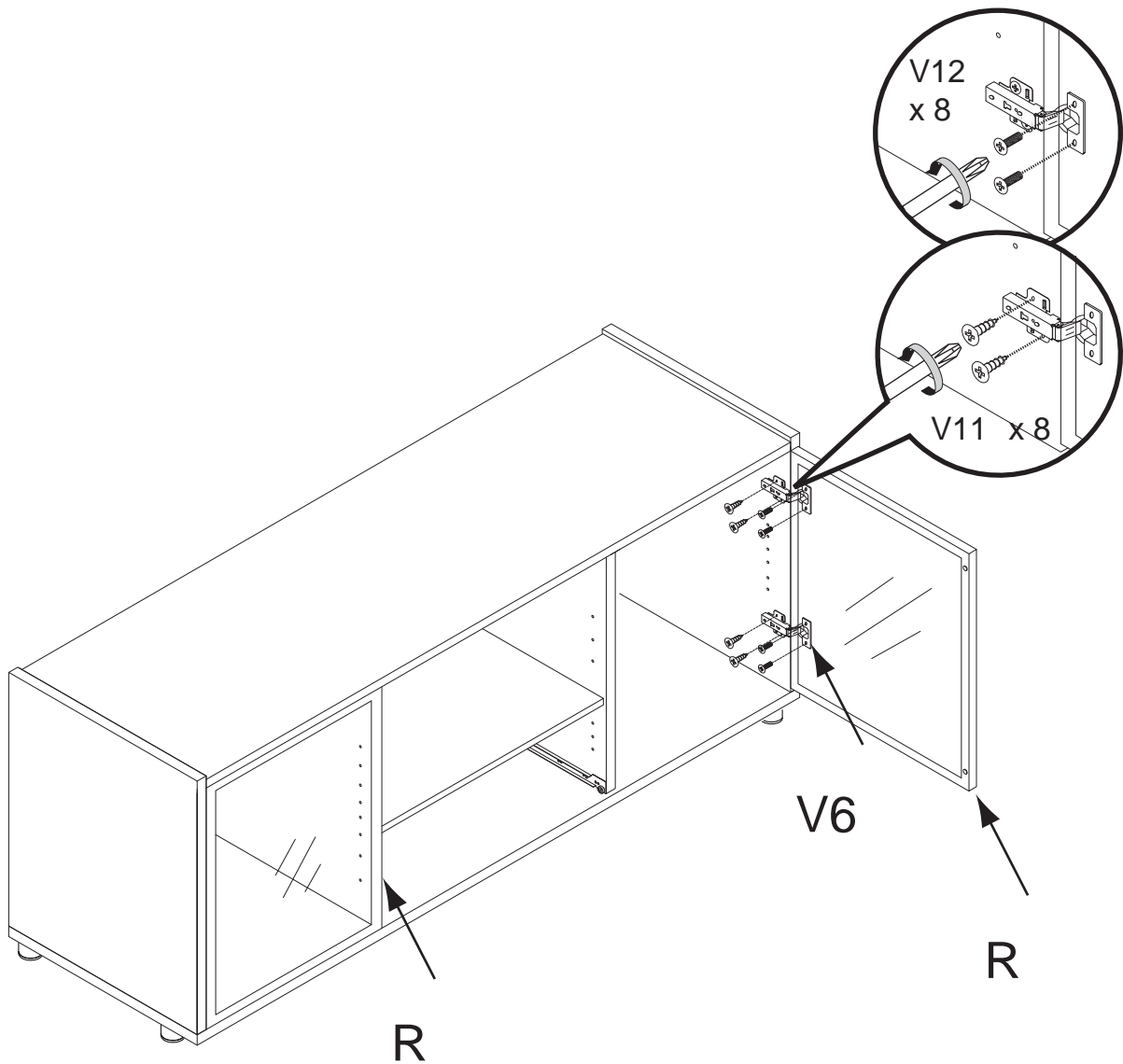

8. Place the hinge(V6) onto the aluminum frame of the door(R)with screws(V12) and then fix the door(R) onto the TV cabinet with screws(V11).

9



V9



V10



V17

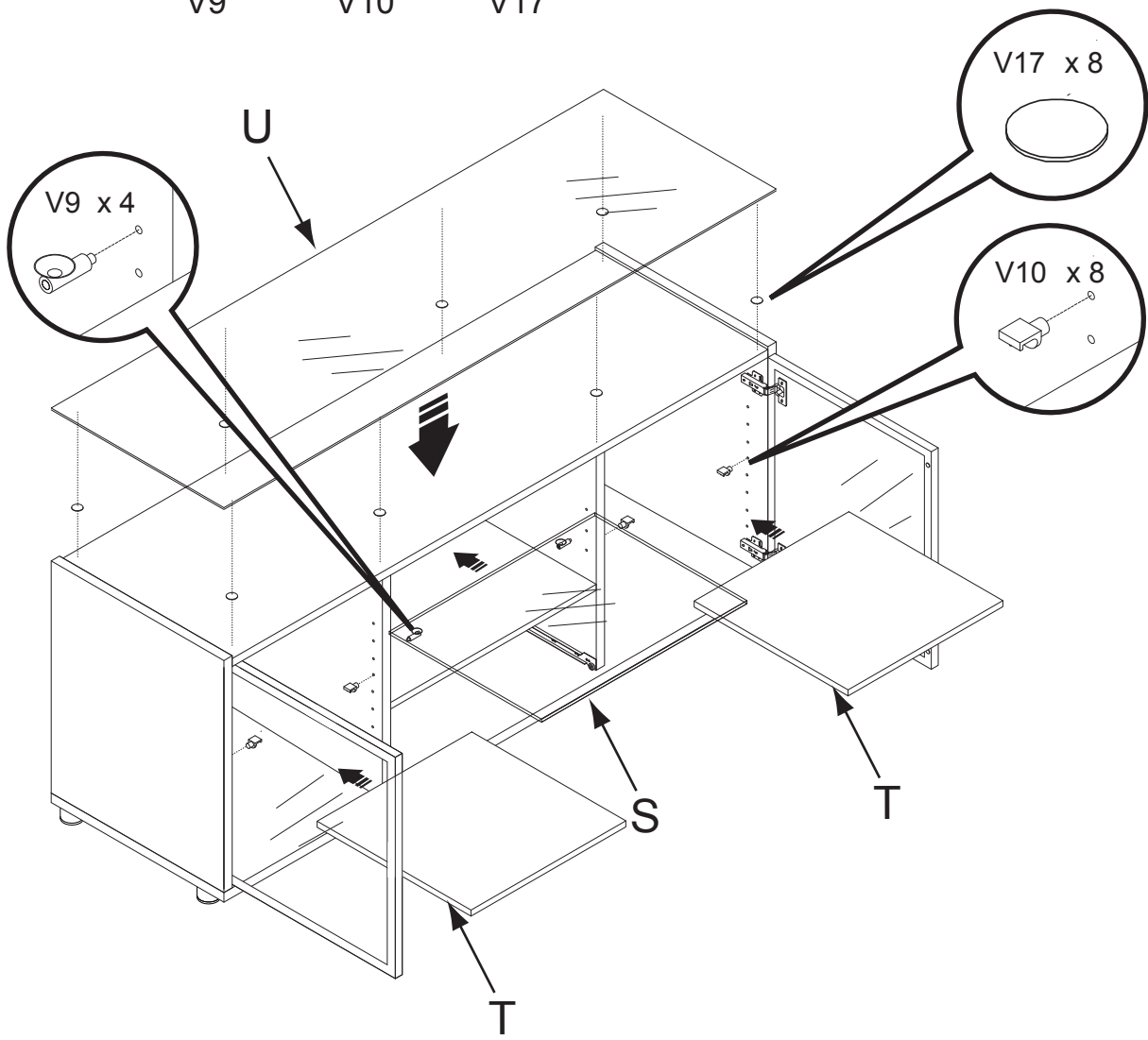

9. Tear the protection skin off top panel and stick the anti-sliding mat (v17) onto the top panel as the drawing shows. Place glass (U) on the TV cabinet top. Place glass shelf (S) on the shelf pins (V9) at desired height. Place wood shelf (T) on the shelf pins (V10) at desired height.

NOTE: Handle items with glass with extra care. Use eye and hand protection. Improper handling can result in cuts or lacerations.

10

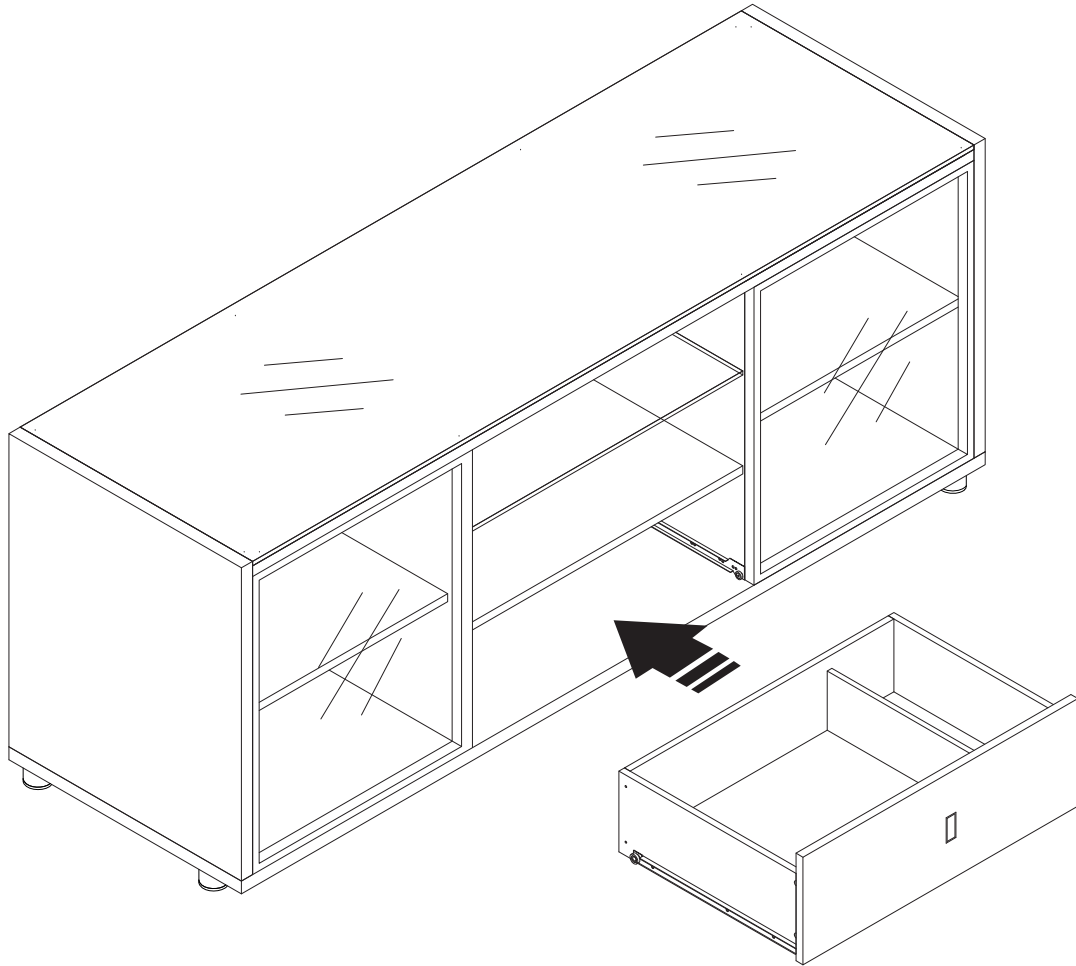

10. Place drawer in the TV cabinet and tear protective skin off the TV cabinet, now that you have completed assembly.

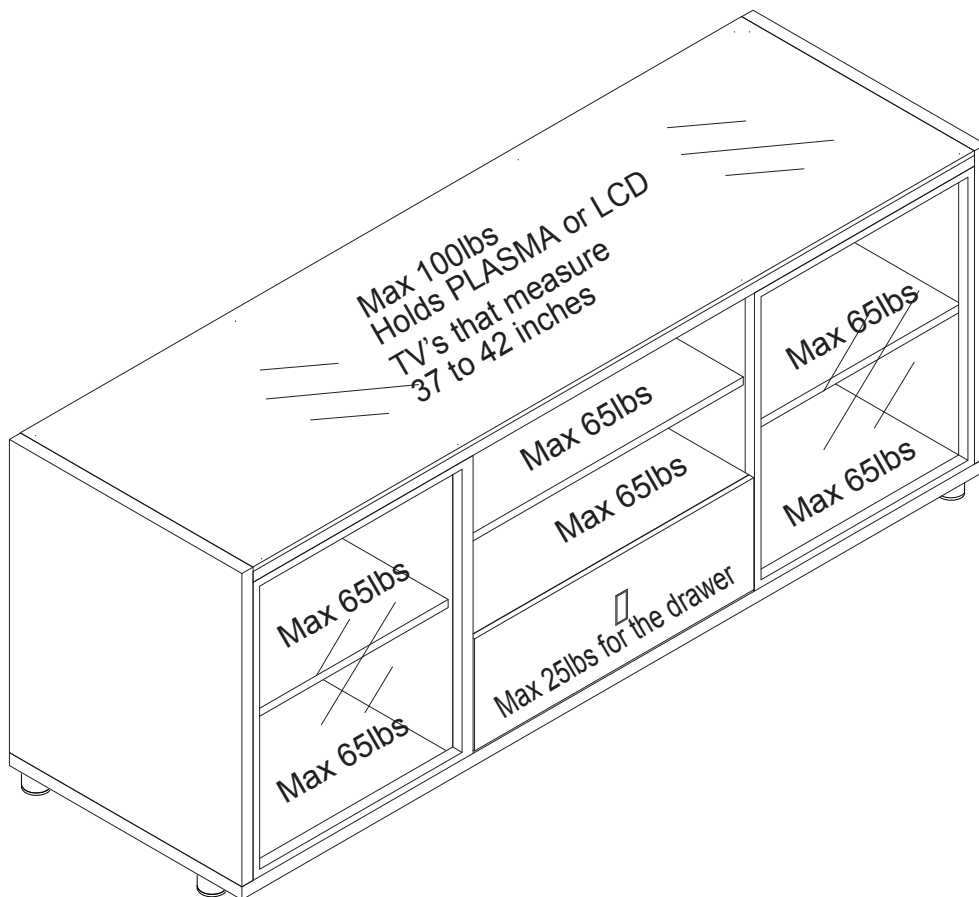

Product Warranty: Atlantic Inc., warrants to the original purchaser that its products are free from defect in materials or workmanship. If after inspection, we find that the product was defective in materials or workmanship, we shall repair or replace the product at our discretion. This warranty does not cover accidental damage, misuse, improper care or alteration and excludes claims for incidental or consequential loss. This limited warranty applies to product purchased in the U.S. and Canada. This warranty gives you specific legal rights and you may also have other rights which vary from State to State. This warranty duration will be last one year.

Keep this Instruction Manual for future reference.  
Keep your original proof of purchase (store receipt).

If parts are missing, DO NOT return to the store.  
To order missing / replacement parts or for assembly assistance please contact [customer\\_relations@atlantic-inc.com](mailto:customer_relations@atlantic-inc.com).  
Or call 1-800-747-2660 M-F, 8am-5pm, P.S.T.

**ATLANTIC®**

©2008 Atlantic Inc. Santa Fe Springs, CA, U.S.A.  
U.S. and other foreign patents pending /  
Patentes de los EUA y países extranjeros en trámite /  
Brevets en cours pour les États-Unis et autres pays /  
U.S. und andere ausländische Patente sind hängig

All rights reserved / Derechos Reservados /  
Tous droits réservés / Alle Rechte vorbehalten

Made in China / Hecho en China /  
Fabriqué en Chine / Hergestellt in China

[www.atlantic-inc.com](http://www.atlantic-inc.com)

R1.2 080820 # 36835515



## Free Manuals Download Website

<http://myh66.com>

<http://usermanuals.us>

<http://www.somanuals.com>

<http://www.4manuals.cc>

<http://www.manual-lib.com>

<http://www.404manual.com>

<http://www.luxmanual.com>

<http://aubethermostatmanual.com>

Golf course search by state

<http://golfingnear.com>

Email search by domain

<http://emailbydomain.com>

Auto manuals search

<http://auto.somanuals.com>

TV manuals search

<http://tv.somanuals.com>