

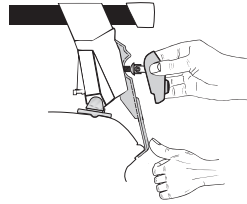

Thule System Kit 249

AUDI A4 4-dr, 95-

MAX
LOAD
75 Kg

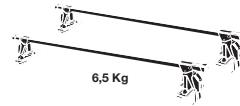

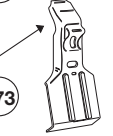
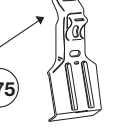
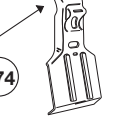
-  **x4**
-  **x2**
-  **x1**
-  **x1**

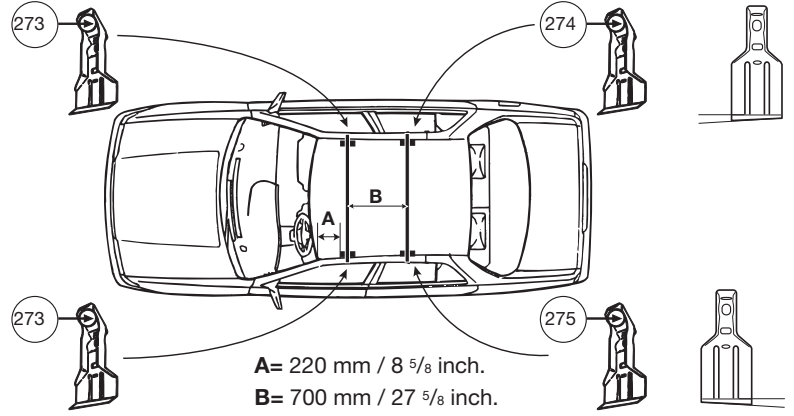
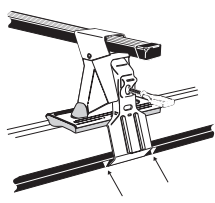
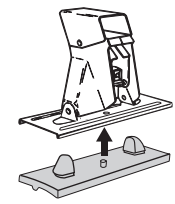

Front	Rear
930 mm / 36 5/8 inch	890 mm / 35 1/8 inch



512•4EF/501-0249-02

Thule System Kit 250

FORD Windstar, 95-

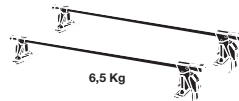
MAX
LOAD
50 Kg

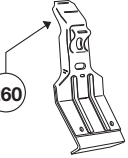
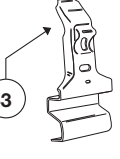

-  **x4**
-  **x4**
-  **x2**
-  **x2**

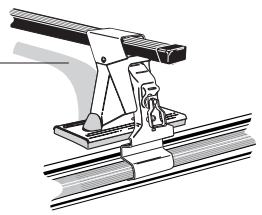
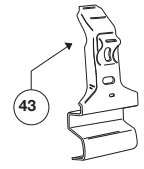
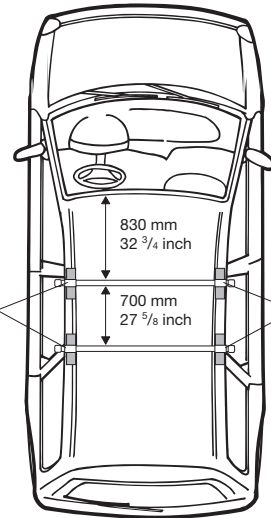
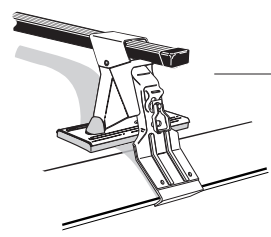
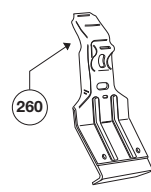
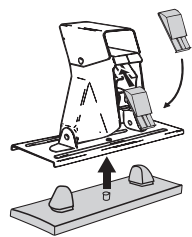

1071 mm / 42 1/8 inch

535•4EF/501-0250-02

Free Manuals Download Website

<http://myh66.com>

<http://usermanuals.us>

<http://www.somanuals.com>

<http://www.4manuals.cc>

<http://www.manual-lib.com>

<http://www.404manual.com>

<http://www.luxmanual.com>

<http://aubethermostatmanual.com>

Golf course search by state

<http://golfingnear.com>

Email search by domain

<http://emailbydomain.com>

Auto manuals search

<http://auto.somanuals.com>

TV manuals search

<http://tv.somanuals.com>