

# *dynakit*

SERIAL NUMBER

14635013

This number must be mentioned in all communications concerning Dynakit.

## INSTRUCTIONS FOR THE ASSEMBLY AND USE OF DYNAKIT STEREO 35 POWER AMPLIFIER

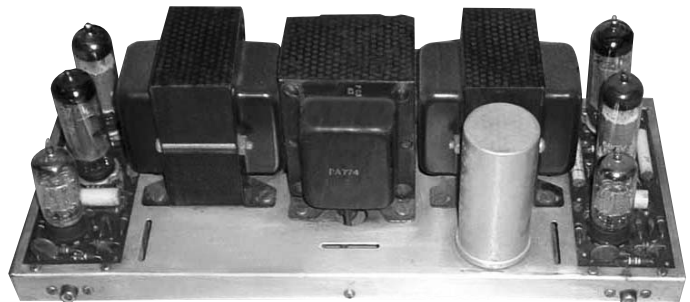

Price **\$1.00**

046414

**DYNA COMPANY**

**DYNACO**

3916 POWELTON AVE  
PHILADELPHIA 4 PA

## CONTENTS

Description	3
General Wiring Practice	4
Mechanical Assembly	5
Wiring instructions	6
240-Volt Transformers	9
Installation	9
In Case of Trouble	10
Part List	11
Schematic Diagram	Back Cover

## SPECIFICATIONS

<b>Power Output:</b>	35 watts continuous, 45 watts IHFM Music Power (both channels)
<b>Frequency Response:</b>	±1db from 10 cps to 40,000 cps.
<b>Power Response:</b>	20 cps to 20,000 cps without exceeding 1% distortion within 1 db of 17,5 watts each channel.
<b>Intermodulation Distortion:</b>	Less than 1% at 17,5 watts each channel. Less than 0.1% at average listening levels.
<b>Hum and Noise:</b>	Inaudible; more than 80 db below rated output.
<b>Sensitivity:</b>	1 volt input for 17.5 watts out- put (each channel).
<b>Input Impedance:</b>	500,000 ohms.
<b>Output Impedance:</b>	8 and 16 ohms.
<b>Damping Factor:</b>	10 from 20 cps to 20,000 cps.
<b>Minimum Channel Separation:</b>	80 db.
<b>Power Consumption:</b>	100 watts, 50/60 cycle a.c.
<b>Tube Complements:</b>	7247 (2), 6BQ5/EL84/7189 (4), silicon diodes (2).
<b>Size:</b>	4" high, 13" wide, 5½" deep.
<b>Shipping Weight:</b>	16 lbs.

## INSTRUCTIONS FOR ASSEMBLY AND USE OF THE DYNAKIT STEREO 35 POWER AMPLIFIER

### DESCRIPTION

The Stereo 35 is a dual power amplifier of deceptively simple appearance and circuitry. Behind its seemingly conventional design is an extremely sophisticated circuit configuration representing the most recent advances in power amplifier engineering and construction. This high degree of technical refinement, combined with the conservative use of premium-grade components, has resulted in a typical Dynakit design offering superb performance at low cost.

Each of the two channels in the Stereo 35 is rated as a 17.5-watt amplifier. Although not evident from this simple rating, the power stated is available on a *continuous* basis at any frequency from 20 to 2,000 cycles per second. A "music power" rating would make the Stereo 35 a 45-watt amplifier, although even this rating would not disclose that full power is available at low distortion throughout the audio spectrum. Nor would such a rating indicate that the Stereo 35, even when driven to power output levels beyond its rating, is able to handle these overloads gracefully, with minimum detriment to the sound. As a result, the Stereo 35 can, if necessary, duplicate the sound intensity of amplifiers with much higher power ratings when called upon to do so.

The heart of the Stereo 35 is the special Dynaco Z-565 output transformer, a patented design tailored specifically to this circuit. The transformer is free of resonances, has extended frequency response (from 6 to over 60,000 cycles), and is wound by special techniques on a carefully designed core to insure low distortion over a wide frequency spectrum. Transformers of this caliber have never previously been used in low-cost equipment of moderate power rating.

The transformer provides an optimum match between the loud speaker load and the output tubes used. These tubes are supplied as a matched group with the kit, and are used in a circuit configuration which gives low inherent distortion and high stability of their d.c. operating point.

The output stage is preceded by a composite voltage amplifier and cathodyne phase inverter (a 7247 tube with direct coupling between sections). The phase inverter used is unique; its operations is independent of the age or condition of the tube. The phase inverter stage is therefore able to maintain its capabilities permanently with no need for adjustment or balancing. Gain in this part of the amplifier is augmented by a feedback connection from cathode to cathode.

Two negative feedback loops, one mostly resistive and the other purely capacitive, are carried over the amplifier to provide 20 db of negative feedback. This provides low

distortion and noise, a high damping factor, and further benefits. The feedback loop is unconditionally stable under all load arrangements, so that the Stereo 35 is suitable for use with any loudspeaker, including electrostatic types.

The values of components selected for the Stereo 35 have been carefully determined, to be certain that the operating conditions for each stage have been set at the center of the optimum range. The use of close tolerance parts provides additional assurance that these settings will not shift, and will remain accurate, so that every amplifier will meet its specifications. This is very important to the kit builder, as it gives immunity from the variations to which much electronic equipment is subject. Heavy-duty circuit boards give additional stability and reproducibility of characteristics, assuring a level of performance which takes full advantage of the capabilities of the design. The conservatively rated power transformer, after testing, is completely sealed in a special encapsulating material which prevents core vibration and also serves to dissipate heat effectively.

One of the outstanding aspects of the design of the Stereo 35 is the attention which has been paid to the reproduction of transient signals. Specifications commonly quoted for amplifiers refer only to performance with pure sine-waves as the signal content; however, music and speech are actually composed of non-repetitive sounds which are non-sinusoidal in character. It is this irregular, or transient type of waveform which the amplifier will usually be called upon to reproduce. Pulse tests and square wave measurements help to evaluate the transient performance of circuits, and these have been applied to derive the correct operating parameters for the Stereo 35. The success of this approach is particularly evident in listening tests where the source material includes percussive sounds—drums, tambourines, piano, cymbals, etc. The Stereo 35 reproduces these sounds with a transparency and absence of blurring which is only obtained when an amplifier has extended frequency response, without bounce, flutter or overshoot. In addition, the Stereo 35 recovers almost immediately from overload, so that the tones immediately following are not affected by the overload signals. Thus, even with low-efficiency speaker systems, where an occasional peak signal might overload the amplifier, reproduction of everything except the highest peak of the heaviest passage is effortlessly reproduced.

It is this characteristic subtlety of design approach which distinguishes the Stereo 35 from other equipment with superficially similar specifications. These differences provide a perceptible improvement in clarity and naturalness of sound; this was the design objective of the Stereo 35, and it has been achieved in a unit of remarkably low cost.

## GENERAL WIRING PRACTICE

Assembly of the Stereo 35 is exceptionally simple when compared to that of the other kits. The circuit board are supplied with all components mounted, and the remaining parts arranged on the chassis in an open, uncluttered way that makes wiring quick and easy. The construction of the Stereo 35 should take no more than few hours.

When you unpack the kit, check the components against the parts list first. You can identify unfamiliar components by matching them to parts illustrated in the pictorial diagram supplied.

Have the proper tools at hand before beginning to build your kit. You will need a pencil-type soldering iron of 30- to 60-watt rating; a long-nosed pliers; diagonal cutters; and a screwdriver. If you have a soldering gun, it should be used with care, especially when working on the circuit board, because of its higher than necessary heat output. Although not essential, a wire-cutting and stripping tool will help considerably; these are available for less than a dollar.

The only procedure involved in building a Dynakit which requires a bit of technique is soldering, and this is quite easy to master. There are four steps to making a good solder connection:

1. Make a good mechanical connection.
2. Heat both parts of the connection with the iron.
3. Apply solder to the connection until it melts and runs.
4. Allow the connection to cool undisturbed.

**ALL SOLDERING MUST BE DONE WITH ROSIN CORE SOLDER.**

There is no warranty on any equipment in which acid core solder has been used. Make sure that the solder you use is plainly marked "Rosin Core". If you have solder on hand of doubtful origin, it is wise to obtain a new roll of 50/50 or 60/40 rosin core solder.

Whenever a connection is to be soldered, the instructions indicate this by the symbol (S). If this symbol is not shown after a step, further connections must be made to the same point before soldering.

A number of steps in the instructions begin, "Connect one end of a wire...", with the length of the wire specified. In each case, first cut a piece of wire to the correct length from the roll supplied with the kit and then remove about  $\frac{1}{4}$ " of insulation from each end before making the connection. The leads on components should be trimmed as they are used, the length chosen being that which permits a connection to be made from point to point without strain on terminals or components. The lead "dress", that is the manner in which the wiring is arranged as it goes from one point to another, should follow that shown in the pictorial diagram as closely as possible. Care must be exercised to see that uninsulated wires do not touch each other, and cannot do so through vibration or sagging, unless of course, they are connected to the same point. It is especially important that uninsulated wires and component leads or terminals do not touch the chassis or bottom plate accidentally.

Check your work after each step, and, when you are satisfied that it has been correctly done, mark the space provided and go on to the next step. Examine the pictorial diagrams often; if you check your work methodically, your amplifier should work as soon as the wiring is complete.

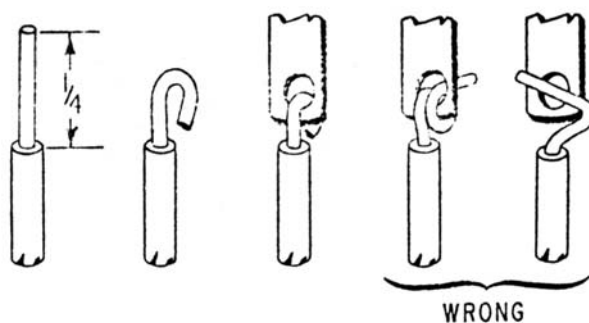

One of the best ways to make a good mechanical connection is to bend a small hook in the end of the wire, and then to crimp this hook onto the terminal to be connected. The amount of bare wire exposed at the end need to be exactly  $\frac{1}{4}$ -inch; however, if it is too long, there is danger of the excess touching another terminal or the chassis. There is no need to wrap the wire around the terminal more than one time, as this makes a connection that is much more difficult to remove if an error has been made

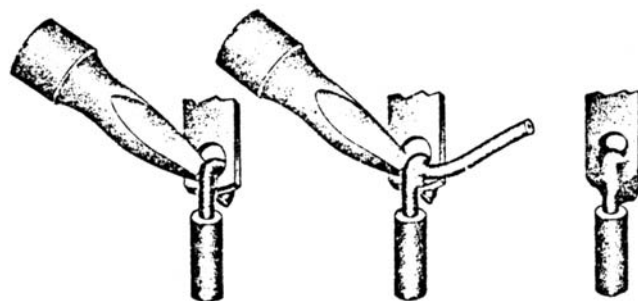

To transfer heat from the iron to the wire and terminal, the tip of the iron should be kept brightly tinned with solder. If this is properly done the first time the iron is used, the tinning may be maintained by wiping the tip with a cloth or sponge every few minutes while soldering. When correctly tinned, the tip will heat both parts of the connection almost immediately. Solder should then be applied directly to the parts to be soldered, as shown in the middle illustration above, and both iron and solder removed as soon as the solder flows freely.

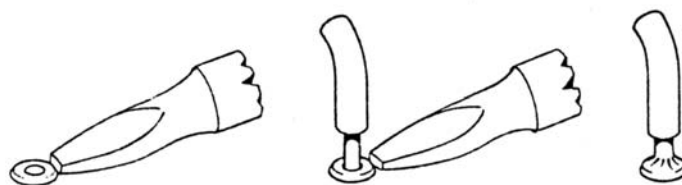

The circuit boards of the Stereo 35 are supplied with all components (resistors and capacitors) already mounted and soldered in place. The circuit boards are connected to the other sections of the amplifier channels by soldering wires to eyelets on the boards. These eyelets, which are numbered for identification, are filled with solder already. To solder a wire to them, they are first heated with the tip of the iron, and the end of the wire inserted as soon as the solder in the eyelet flows. A correctly made connection looks like the illustration at the right, above, which shows a smooth transition from eyelet to wire.

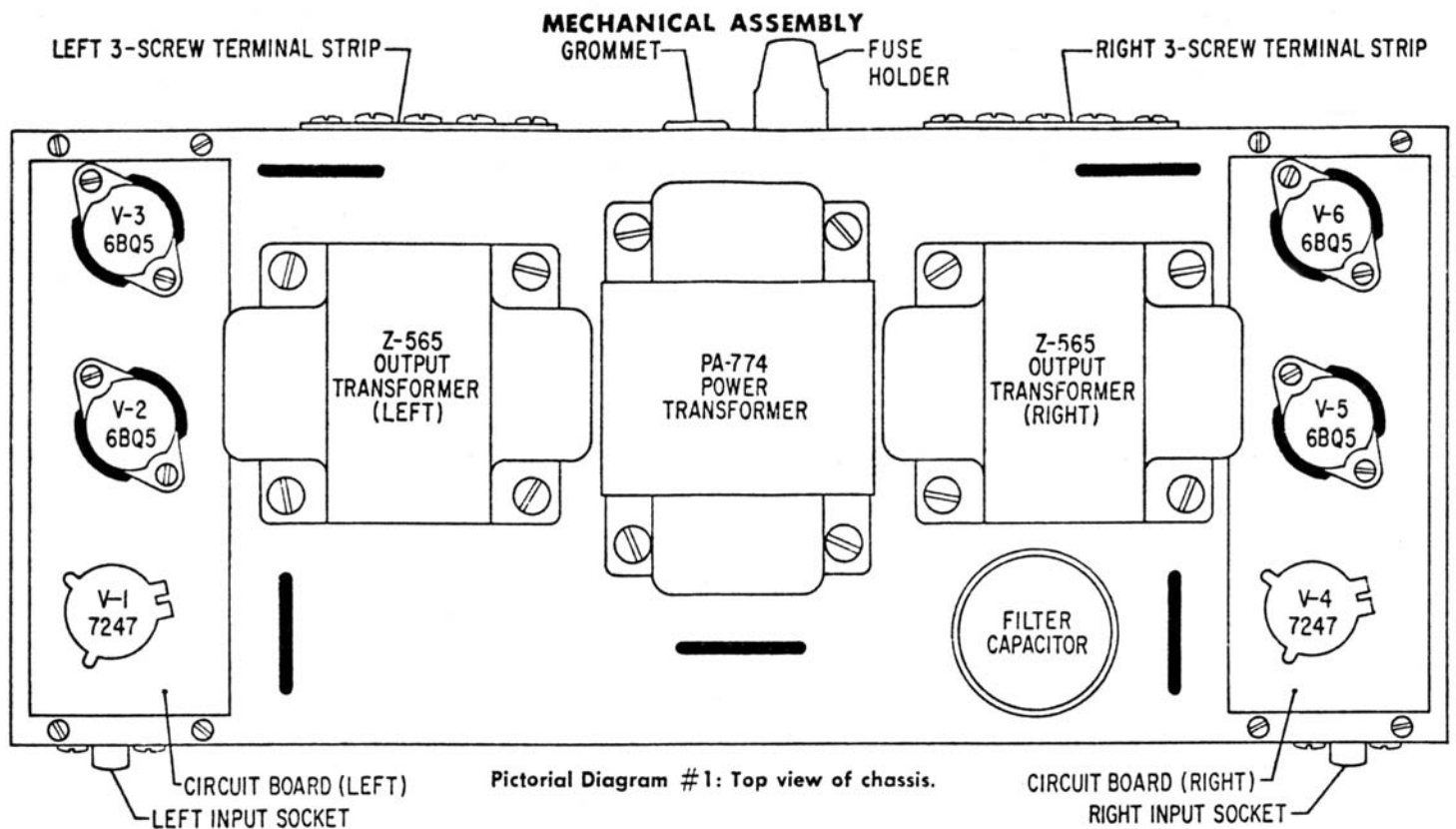

CHECK PICTORIAL DIAGRAMS #1 AND #3 BEFORE AND AFTER DOING EACH STEP.

- 1( ) Mount the two 3-screw terminal strips on the outside of the chassis in the cutouts provided, using #4 screws, nuts and lockwashers (the smallest size supplied). The pictorial diagram shows the correct orientation of the terminal strips.
- 2( ) Mount the fuse holder in its cutout, fastening it in place with the circular brass threaded ring. The rubber washer goes on the outside of the chassis; by maintaining pressure against the fuse holder from the outside, with one hand, while tightening the brass ring with the other hand. The fuse holder can be mounted securely without tools. Be sure that the fuse holder terminals are oriented exactly as shown in the diagram. After mounting, terminal lug B should be bent away from the body of the fuse holder at the angle shown in the pictorial diagram.
- 3( ) Mount the 5-lug terminal strip on the side of the chassis, as shown in the diagram, using a #4 screw, lockwasher and nut.
- 4( ) Install the four sockets supplied for V-2, V-3, V-5 and V-6 on top of the two PC-13 circuit boards. Note that the sockets are not all installed in the same way; pictorial diagram #2 shows the correct orientation for each socket. Mount each socket with two sets of #4 hardware. Do not over-tighten.
- 5( ) Mount the two PC-13 circuit boards in the rectangular cutouts at each end of the chassis; note that the boards are mounted from the inside of the chassis. Before mounting each board with four sets of #4 hardware, study the diagram to be sure that the boards will be properly oriented on the chassis.
- 6( ) Install the two input sockets from the inside of the chassis, using two sets of #4 hardware to mount each socket. The long (center) lug of each socket should be closest to the circuit board.

- 7( ) Mount the filter capacitor in the cutout provided. First, look at the symbols stamped in the plastic at the base of each connecting lug; These *must* be oriented as shown in the pictorial diagram. Insert the four mounting lugs of the capacitor in the slots and then twist each of the mounting lugs one-quarter turn with a pliers while holding the capacitor snugly against the chassis with your other hand.
- 8( ) Pass the leads of one of the output transformers (marked Z-565) through the two holes provided in the chassis. The orange, black and yellow leads go through the hole closest to the center of the chassis, as shown in the diagram. Mount the transformer loosely with four #8 screws, nuts and lockwashers (the largest size supplied). After adjusting its position so that it is as close to the circuit board as possible, tighten the screws.
- 9( ) Pass the leads of the other output transformer (Z-565) through the two holes provided in the chassis, again observing that the black, orange and yellow leads go through the hole closest to the center of the chassis. Mount the transformer loosely with four sets of #8 hardware, position it as close to the circuit board as possible, and tighten the screws.
- 10( ) Pass the leads of the power transformer (PA-774) through the two holes provided at the center of the chassis. A group of four leads go through the hole nearest to the fuse holder, and five\* leads through the other hole. Mount the power transformer with four sets of #8 hardware, but do not tighten the screws immediately. First, center the power transformer so that it is evenly spaced between the two output transformers. Then, tighten the screws.
- 11( ) Insert the rubber grommet in the hole in the chassis through which the line cord is to pass.

\*Seven leads in 240-volt transformer PB-028, for use outside the United States. Special instructions for installing PB-028 begin at the conclusion of these instructions.

## WIRING INSTRUCTIONS

Refer to pictorial diagram #2 before and after each step. After making a connection, bend (dress) each lead or wire so that it follows the path shown in the diagram as closely as possible. After all connections have been made to a terminal and it is soldered cut off any excess wire.

- 1( ) Begin with the group of five leads from the power transformer PA-774, all of which come through the in the chassis opposite of fuse holder.

NOTE: Special instructions for wiring PB-028 the 240-volt power transformer, are at the end of these instructions.

When cutting transformer leads to correct length strip the insulation at the end of each lead to expose about  $\frac{1}{4}$ " of wire. Tin the exposed end, by heating it with the soldering iron and melting a bit of solder onto it; this will keep the end from fraying, and permits a more secure mechanical connection. Measure the length with a ruler, from the chassis to the end of the lead, while holding the lead straight out from and perpendicular to the chassis. Cut one of the black leads to  $1\frac{1}{2}$ " in length, and connect it to lug #4 of the 5-lug terminal strip. Do not solder, remember, a connection is only to be soldered when the symbol (S) is printed after the instruction.

- 2( ) Cut the other black lead to  $3\frac{1}{2}$ ", and connect it to terminal B of the fuse holder (S).
- 3( ) Twist together the two red power transformer leads. Connect one of them to lug #1 of the 5-lug terminal strip.
- 4( ) Connect the other red power transformer lead to lug #2 of the 5-lug terminal strip.
- 5( ) Cut the red-and-yellow power transformer lead to  $3\frac{1}{2}$ " in length, and connect it to chassis-mounting lug A of the filter capacitor.
- 6( ) The four remaining power transformer leads are connected next. Cut the green and green-and-white leads to 6" each, and twist them together, as shown in the diagram. Connect the green-and-white lead to pin #5 of V-3 on the LEFT circuit board.
- 7( ) Connect the green power transformer lead to pin #4 of V-3. IMPORTANT: Because the tube socket lugs are small and closely spaced, it is imperative that all connections to them be made with care. Keep stripped wire ends as short as possible; insert them in the lugs up to insulation; cut off excess immediately after soldering each connection; check each time to be certain that nearby terminals and hardware cannot accidentally be touched by bare wire ends.
- 8( ) Cut the brown and the brown-and-white power transformer leads to 6". Twist them together, and connect the brown-and-white lead to pin #5 of V-6 on the RIGHT circuit board.
- 9( ) Connect the brown power transformer lead to pin #4 of V-6.
- 10( ) The LEFT output transformer leads are connected next. Carefully cut the blue-and-white and green-

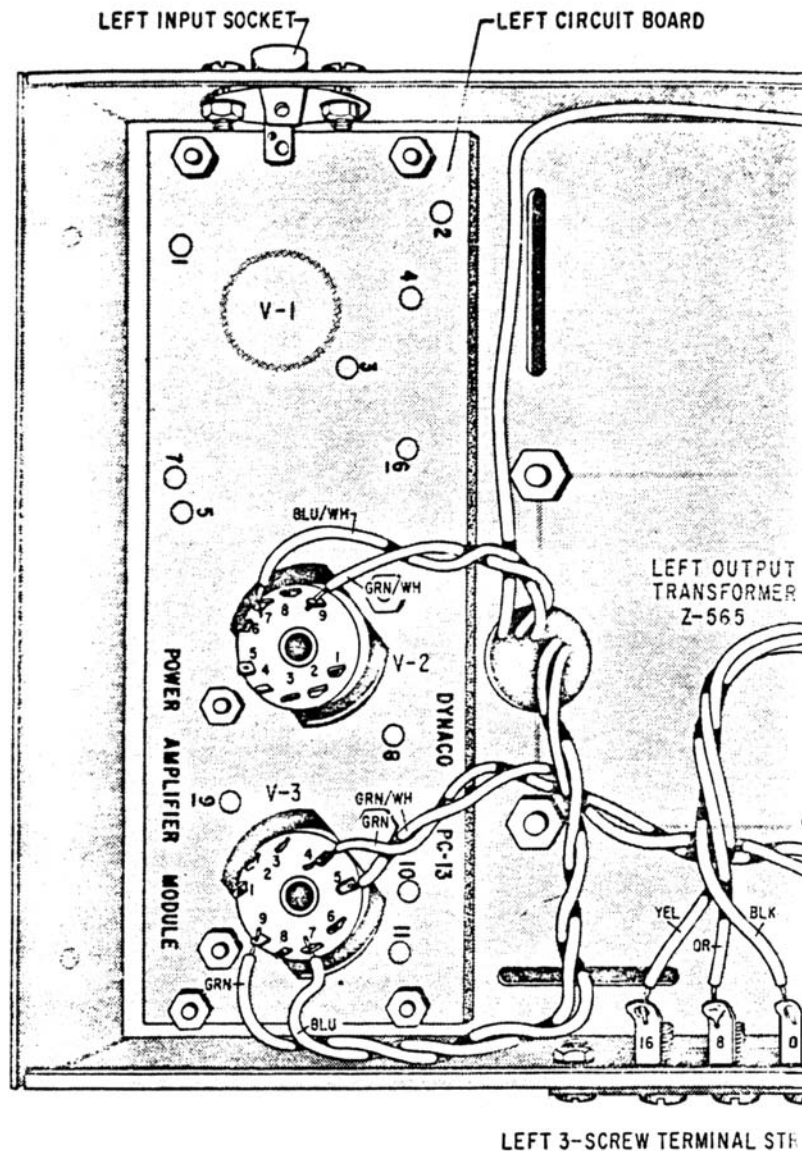

LEFT 3-SCREW TERMINAL STR

and-white leads from the LEFT output transformer to exactly 2" in length. Strip and tin the ends, and twist the leads together, as in the diagram. Connect the blue-and-white lead to pin #7 of V-2 on the LEFT circuit board (S).

- 11( ) Connect the green-and-white lead to pin #9 of V-2 (S).
- 12( ) Twist together the blue and green leads from the LEFT output transformer. Connect the blue lead to pin #7 of V-3 on the LEFT circuit board (S).
- 13( ) Connect the green lead to pin #9 of V-3.
- 14( ) Connect the red lead from the LEFT output transformer to lug #2 of the filter capacitor. This is the lug next to *square* symbol on the plastic underside of the capacitor, and should be in the position shown in the pictorial diagram.

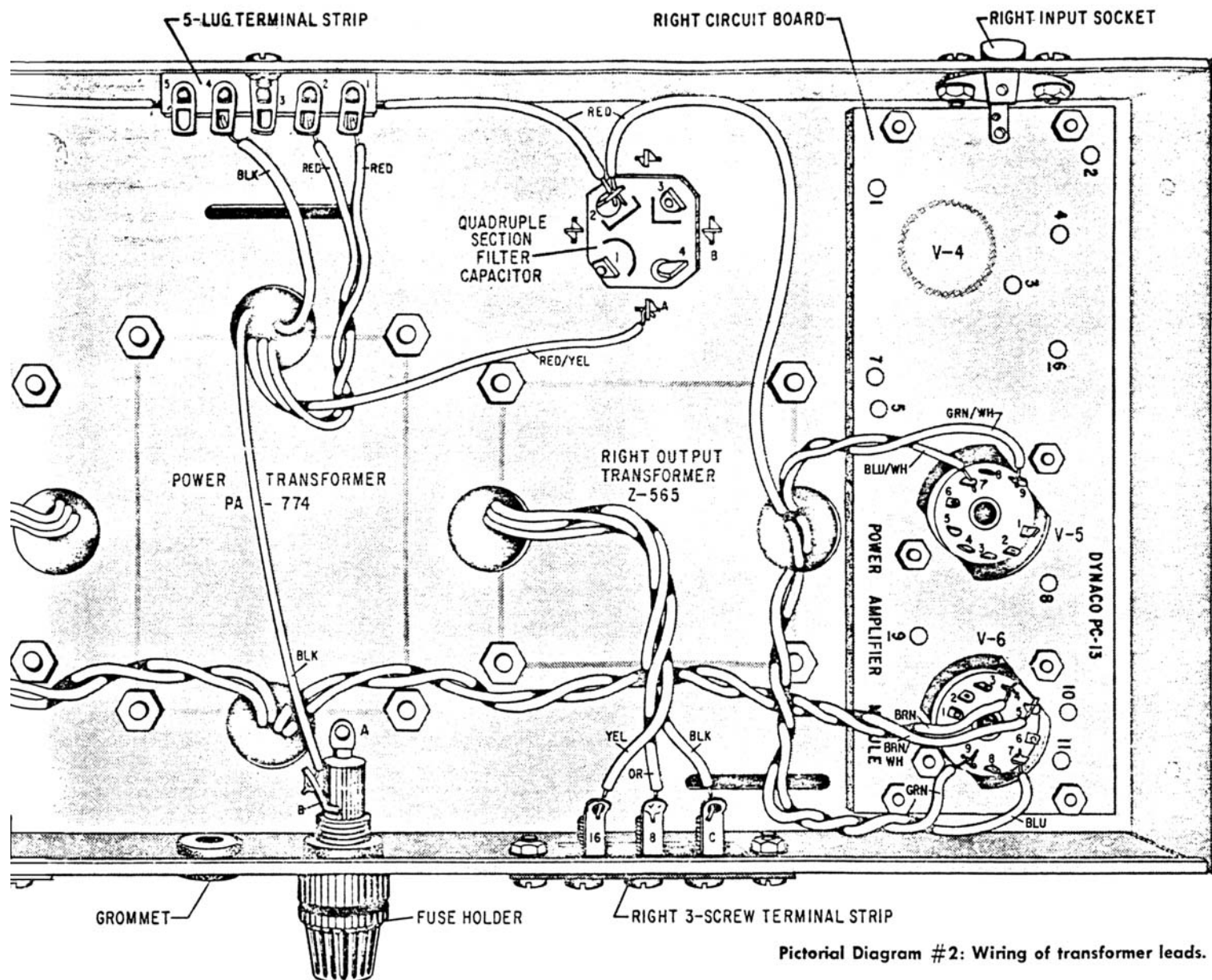

Pictorial Diagram #2: Wiring of transformer leads.

- 15( ) Cut the black, orange and yellow leads of the LEFT output transformer to  $3\frac{1}{2}$ " long. Twist all three of these leads together, and connect the black lead to lug C of the LEFT 3-screw terminal strip.
- 16( ) Connect the orange lead to lug 8 of the LEFT 3-screw terminal strip (S).
- 17( ) Connect the yellow lead to lug 16 of the LEFT 3-screw terminal strip.
- 18( ) The RIGHT output transformer leads are connected next. First, cut the blue-and-white and green-and-white leads to exactly 2" long. Strip and tin the ends, and twist the leads together. Connect the blue-and-white lead to pin #7 of V-5 on the RIGHT circuit board (S).
- 19( ) Connect the green-and-white lead to pin #9 of V-5 (S).
- 20( ) Twist together the blue and green leads from the RIGHT output transformer. Connect the blue lead to pin #7 of V-6 on the RIGHT circuit board (S).
- 21( ) Connect the green lead to pin #9 of V-6. Be sure that exposed wire or stray filaments from them cannot touch other wires or terminals, or cause a short-circuit to the chassis hardware.
- 22( ) Cut the red lead from the RIGHT output transformer to  $4\frac{1}{2}$ " long, and connect it to lug #2 of the filter capacitor (square symbol).
- 23( ) Cut the black, orange and yellow leads of the RIGHT output transformer to  $3\frac{1}{2}$ " long. Twist these three leads together, and connect the black lead to lug C of the RIGHT 3-screw terminal strip.
- 24( ) Connect the orange lead to lug 8 of the RIGHT 3-screw terminal strip (S).
- 25( ) Connect the yellow lead to lug 16 of the RIGHT 3-screw terminal strip.

### REFER TO PICTORIAL DIAGRAM #3.

- 26( ) Connect one end of the 6800-ohm (blue, gray, red), 1-watt resistor to lug #2 (square symbol) of the filter capacitor. Connect the other end to lug #3 (triangle symbol) of the capacitor. The resistor leads should be cut to permit mounting exactly as is shown in the diagram.
- 27( ) Connect one end of the 50-ohm, 5-watt resistor to lug #1 (*curved line symbol*) of the filter capacitor. Connect the other end to lug #2 (*square symbol*) of the capacitor (S). Check to be sure that all four of the connections at lug #2 have been soldered, and that excess wire has been trimmed away, and cannot touch the chassis or adjacent lugs.
- 28( ) Connect one end of the 95-ohm, 5-watt resistor to lug #4 (no symbol) of the filter capacitor. Connect the other end to chassis-mounting lug B of the capacitor.
- 29( ) Connect one end of a 5" wire to chassis-mounting lug B of the filter capacitor (S). Connect the other end to lug #3 of the 5-lug terminal strip (S).

30( ) The silicon rectifier diodes supplied with the kit may be of any of the three types shown in the illustration; although differing in external appearance, the three types are electrically equivalent.

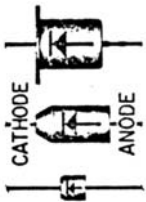

Connect the CATHODE lead of one of the rectifier diodes to lug #1 (*curved line symbol*) of the filter capacitor. Connect the ANODE lead to lug #2 of the 5-lug terminal strip (S). IMPORTANT: Arrange the diode leads exactly as shown in the pictorial diagram. When soldering,

hold a pliers on the lead between the diode body and the solder connection to avoid application of excessive heat to the diode.

- 31( ) Connect the CATHODE lead of the other rectifier diode to lug #1 (*curved line symbol*) of the filter capacitor (S). Connect the other lead to lug #1 of the 5-lug terminal strip (S). Observe the same precautions when soldering as in the preceding step.
- 32( ) Connect one end of a 4" wire to lug C of the RIGHT 3-screw terminal strip (S). Connect the other end to chassis-mounting lug A of the filter capacitor.
- 33( ) Connect end of a 9" wire to lug C of the LEFT 3-screw terminal strip (S). Connect the other end to chassis-mounting lug A of the filter capacitor (S).
- 34( ) Connect one end of a 4" wire to lug #3 (triangle symbol) of the filter capacitor. Connect the other end to eyelet #7 of the RIGHT circuit board (S).

NOTE : Before making a connection to an eyelet on the circuit board, tin the end of the wire by heating it with the soldering iron and touching solder to it. The wire end is tinned when the solder melts and runs onto the wire. The eyelets on the board already have solder in them. To solder to the eyelet, heat it with the soldering iron and insert the end of the wire when the solder in the eyelet flows. Remove the iron and hold the wire in place until the solder hardens.

- 35( ) Connect one end of a 5" wire to lug #4 (no symbol) of the filter capacitor. Connect the other end to pin #3 of V-5 on the RIGHT circuit board.
- 36( ) Prepare a 1¼" piece of wire by stripping ½" of insulation from one end, and ¼" from the other end.

Push the longer bare end through pin #3 of V-6 on the RIGHT circuit board (S), and bend it around to connect to pin #4 of V-6 also. Connect the other end to pin #3 of V-5 (S).

- 37( ) Connect one end of a 4½" wire one to eyelet #4 of the RIGHT circuit board (S). Connect the other end to eyelet #10 (S).
- 38( ) Twist together a 2½" and a 4" wire so that one pair of ends is even. Connect the matching end to pins #4 and #5 of V-5 on the RIGHT circuit board. Connect the shorter of the remaining end to eyelet #5 (S), and the longer remaining end to eyelet #3 (S).
- 39( ) Twist together a pair of 2½" wires. Connect one pair of ends to pin #4 (S) and pin #5 (S) of V-5 on the RIGHT circuit board. Connect the other ends to pin #4 (S) and pin #5 (S) of V-6.
- 40( ) Connect one end of a 7" wire to lug 16 of the RIGHT 3-screw terminal strip (S). Connect the other end to eyelet #6 of the RIGHT circuit board (S).
- 41( ) Connect one end of a 1¼" wire to pin #9 of V-6 on the RIGHT circuit board (S). Connect the other end to eyelet #11 (S).
- 42( ) Connect one end of a 1" bare wire to pin #2 of V-6 on the RIGHT circuit board (S). Connect the other end to eyelet #9 (S).
- 43( ) Connect one end of a 1" bare wire to pin #2 of V-5 on the RIGHT circuit board (S). Connect the other end to eyelet #8 (S).
- 44( ) Connect one end of a 1" wire to the long lug of the RIGHT input socket (S). Connect the other end to eyelet #1 (S).
- 45( ) Connect one end of a 1½" wire to the short lug of the RIGHT input socket (S). Connect the other end to eyelet #2 (S).
- 46( ) The next group of steps are performed on the LEFT circuit board. Connect one end of a 12" wire to lug #3 (triangle symbol) of the filter capacitor (S). Connect the other end to eyelet #7 of the LEFT circuit board (S).
- 47( ) Connect one end of a 10" wire to lug #4 (no symbol) of the filter capacitor (S). Connect the other end to pin #3 of V-2 on the LEFT circuit board.
- 48( ) Strip ½" insulation from one end of a 1¼" piece of wire; strip about ¼" from the other end. Push the longer bare end through pin #3 of V-3 on the LEFT circuit board (S), and then bend it back to connect it to pin #4 of V-3. Connect the other end to pin #3 of V-2 (S).
- 49( ) Connect one end of a 4½" wire to eyelet #4 of the LEFT circuit board (S). Connect the other end to eyelet #10 (S).
- 50( ) Twist together a 2½" and a 4", so that one pair of ends is even. Connect the matching ends to pins #4 and #5 of V-2 on the LEFT circuit board. Connect the shorter of remaining ends to eyelet #5 (S), and the longer end to eyelet #3 (S).
- 51( ) Twist a pair of 2½" wires together. Connect one pair of ends to pin #4 (S) and pin #5 (S) of V-2 on the LEFT circuit board, and the other ends to pin #4 (S) and pin #5 (S) of V-3.
- 52( ) Connect one end of 5" wire to lug 16 of the LEFT 3-screw terminal strip (S). Connect the other end to eyelet #6 of the LEFT circuit board (S).



- 53( ) Connect one end of a 1¼" wire to pin #9 of V-3 on the LEFT circuit board (S). Connect the other end to eyelet #11 (S).
- 54 ( ) Connect one end of a 1" bare wire to pin #2 of V-3 on the LEFT circuit board (S). Connect the other end to eyelet #9 (S).
- 55( ) Connect one end of another 1" bare wire to pin #2 of V-2 on the LEFT circuit board (S). Connect the other end to eyelet #8 (S).
- 56( ) Connect one end of a 1" wire to the long lug of the LEFT input socket (S). Connect the other end to eyelet #1 (S).
- 57( ) Connect one end of a 1½" wire to the short lug of the LEFT input socket (S). Connect the other end to eyelet #2 (S).
- 58( ) Insert the line cord through the rubber grommet mounted on the chassis, and push it through far enough to tie a knot about 5" from the end. Tie the knot. Then separate the two conductors of the line cord for about 4". Cut 1½" from one of them, and strip and tin the ends of both.
- 59( ) Connect the longer of the two line cord conductors to lug #4 of the 5-lug terminal strip (S). Connect the other conductor to lug A of the fuse holder (S). This completes the wiring of the Stereo 35.

#### PLACES TO DOUBLE CHECK AFTER WIRING

- ( ) Be sure that all mounting screws and nuts are tight.
- ( ) Compare the wiring of each of the tube sockets to that shown in the pictorial diagram. All connections should be securely soldered, with enough space between connections to the tube pin lugs so that there is no chance of an accidental short-circuit.
- ( ) Compare the wiring to each lug of the filter capacitor with that shown on the diagram. Check carefully to see that all connections are soldered, and that excess lead length has not caused any connection to short-circuit to the chassis. Count the wires going to each terminal on diagram and amplifier.
- ( ) Use special care in examining all connections, to be sure that none of them are high enough to touch the bottom plate when it is installed. Check the 5-lug terminal strip and filter capacitor closely.

The tubes and fuse may now be installed. The socket on each board which is supplied already mounted is for the 7247 tube. Each of the two sockets installed and wired during assembly receives one of the 6BQ5 tubes. **IMPORTANT:** When inserting the tubes in their sockets for the first time, the socket should be supported from below to avoid strain on the circuit board, due to the tight fit of new sockets. The amplifier a.c. cord should NOT be plugged into a wall outlet until after the tubes are installed, and the cover and bottom plate are securely in place.

The cover and bottom plate are attached at the same time, by setting the amplifier chassis on the bottom plate, which fits inside the chassis, and then lowering the cover onto the chassis. The three pieces are fastened together by four sheet metal screws through the sides of the chassis. The four rubber feet are installed by pressing them into the corner holes of the bottom plate. The cover should be used whenever the amplifier is operated where it may be touched accidentally; not only do the tubes become quite hot in operation, but some point on the circuit board carry a voltage which, while non lethal, can be quite uncomfortable if touched while the amplifier is on.

#### SPECIAL INSTRUCTIONS FOR OPTIONAL 120-240 VOLT POWER TRANSFORMERS

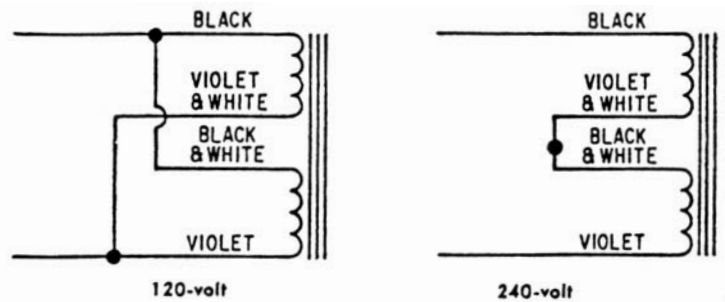

Dynakit Stereo 35 amplifiers supplied with power transformer PB-028 can be wired for use with either 120- or 240-volt a.c. power sources, in the following way:

#### For 120-volt operation.

- ( ) Begin with the group of seven leads from the power transformer, all of which should come through the hole in the chassis farthest from the fuse holder. Connect the black lead to terminal B of the fuse holder.
- ( ) Connect the black-and-white lead to terminal B of the fuse holder (S).
- ( ) Connect the violet lead to lug #4 of the 5 lug terminal strip.
- ( ) Connect the violet-and-white lead to lug #4 of the 5-lug terminal strip.

Proceed with the wiring steps in the regular assembly portion of this booklet, beginning with wiring step #3.

#### For 240-volt operation.

- ( ) Connect the violet-and-white lead to lug #5 of the 5-lug terminal strip.
- ( ) Connect the black-and-white lead to lug #5 of the 5-lug terminal strip (S).
- ( ) Connect the black lead to terminal B of the fuse holder (S).
- ( ) Connect the violet lead to lug #4 of the 5-lug terminal strip.

Proceed with the wiring steps in the regular assembly portion of this booklet, beginning with the wiring step #3.

#### INSTALLING THE STEREO 35

In addition to the Stereo 35, your complete stereo system will include one or more signal source (turntable, tuner, tape transport), a stereo preamplifier (unless included with the signal source), and two loudspeakers.

Installation of the Stereo 35 is simple. You will need two shielded audio cables for the inputs (usually provided with the preamplifier) and two lengths of two-conductors wire with which to make the connections to the loudspeakers. Ordinary lamp cord will do for the latter.

The Stereo 35 is designed for use with stereo preamplifiers which have their own power supply, such as the Dyna PAS-3. In addition to a high level of performance, the preamplifier should be capable of delivering a signal of about 1 volt to drive the Stereo 35 to its full output. The Stereo 35 a.c. line cord should be connected to a switched auxiliary a.c. outlet on the preamplifier; in this way, it will be turned on and off automatically when the preamplifier is switched on and off. Since the Stereo 35 contains its own fuse, an outlet which is not fused may be used.

The Stereo 35 may also be used with an FM tuner without need for a preamplifier, provided that the tuner is equipped with a volume control and switched a.c. outlet, and has an out put of at least 1 volt.

The loud speakers chosen may be of any impedance or efficiency, since the Stereo 35 has sufficient power reserve beyond that usually required for home listening so that no lack of volume is likely to be observed, even with relatively inefficient speakers. The loudspeakers connection for each channel is made between the COM (common) and either the 8- or 16-ohm tap provided; the bottom plate is printed to identify these terminals. The 8-ohm tap will permit satisfactory operation with loudspeakers of 4- to 12-ohm nominal impedance, while the 16-ohm tap may be used with loudspeakers of 12- to 20-ohm rating.

### PHASING THE LOUDSPEAKERS

The two loudspeakers used in a stereo system must be phased properly for correct stereo reproduction. The phasing process itself is simple, after the amplifier is operating and the two loudspeakers are connected.

Play a monophonic record, or tune in a monophonic broadcast on your tuner. As you walk across the room in front of the loudspeakers, there should be a smooth, continuous transition of sound from one side of the room to the other. When you are directly between the loudspeakers, the sound should appear to come from a source that is directly in front of you, that is, also centered between the loudspeakers. If you have any doubt as to whether or not the phasing is correct, after making this test, transpose the two connections at *one* of the amplifier terminal strips; that is, connect the wire which was connected to "8" or "16" to "COM", and vice versa. If you have changed to the correct phasing, the sound will now be distinctly centered, and the bass tones will appear to have increased. If you have changed the connection to incorrect phasing, the sound will seem to jump from one side to the other as you move slightly to the right and left of center.

### LISTENING WITH STEREO HEADPHONES

Headphones can be used with the Stereo 35 in place of loudspeakers or connected in addition to loudspeakers. Most headphone manufacturers supply instructions and special junction boxes which permit direct connection of headphones to the loudspeaker outputs of the amplifier.

With low impedance headphones (4 to 16 ohm rating), without instructions from the manufacturer, a 1-watt resistor of about 100 ohms should be connected in series with the output of each channel. This will attenuate the signal to each headphone, improving the signal to noise ratio.

### CONNECTING A THIRD LOUDSPEAKER TO YOUR STEREO SYSTEM

In most stereophonic systems, the usual arrangement of two loudspeakers which form an equilateral triangle with the listener's position will yield optimum performance. In cases where the program contains exaggerated separation, judicious use of the blend control on the preamplifier will provide a more natural and pleasing effect.

When room arrangement or size does not permit the ideal placement of loudspeakers, the addition of a third loudspeaker, playing a combination of the left- and right-channel material, may improve the spatial effect considerably. Those listeners who feel a need for a third loudspeaker, can try this arrangement without need for a third amplifier

or a special output on their preamplifier by using the following method. A monophonic extension loudspeaker may be connected to a stereo system in the same way.

The circuit shown below provides output from a central loudspeaker with full control over its level. For best results, the speakers used should be identical.

Be certain that the loudspeakers are properly phased.

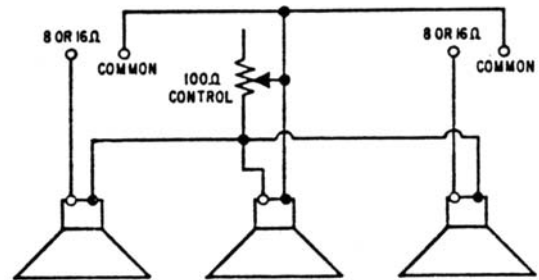

### IN CASE OF TROUBLE

The Stereo 35 has been carefully engineered to give long, trouble-free service. However, a mistake in assembly or a defective component can affect its performance or make it inoperative. If difficulty is encountered, a methodical analysis of the trouble will usually lead to a quick cure. The first thing to check is the wiring to be sure that all of the steps have been performed, and that all connections have been soldered. It is especially helpful to have someone other than the builder do the checking.

*If the tubes do not light at all* ( on both channels), it is likely that a.c. power is not being delivered to the amplifier. In all likelihood, the fuse will have blown, indicating the possibility of a short-circuit in either the filament or high voltage supply lines. If the resistance between chassis ground and the quad filter capacitor lugs is less than 100,000 ohm, this indicates a probable short-circuit in the high-voltage supply.

*If the tubes of one channel light*, but those of the other do not, the filament leads from the power transformer to one of the circuit boards are probably non properly connected, or these may be defective in the power transformer.

*If all tubes light but one*, the tube in question should be interchanged with one of the same type from another socket on either board. This should show whether the tube or its associated circuitry is at fault; if the tube still fails to light, it is faulty. If it lights in its new position, and the tube inserted in its place is now dark, a close examination of the tube socket wiring will usually reveal the source of the difficulty. Should an output tube (6BQ5) ever require replacement, it is preferable, but not essential, that the pair be replaced.

*If all of the tubes light*, but there is no sound from the loudspeakers when the system is in operation, it is first necessary to eliminate other components in the system as possible cause of the trouble. Inserting or removing the input plugs at the input sockets of the Stereo 35, while it is on should produce a loud momentary hum or "thump". If the loudspeakers are properly connected, and no noise is produced by inserting or removing the input plugs, the high voltage supply is probably not connected. check the wiring around the quad filter capacitor. If one channel plays, and the other does not, check the signal path in the defective channel, as well as the high voltage supply. Another possibility is that strands of wire from the output transformer leads going to the output terminal strip are accidentally shorting, or that the wires leading to the loudspeakers are touching the chassis or each other.

If hum and noise are present to any unusual degree, first remove the inputs plugs from the Stereo 35, and replace them with short-circuited input plugs (or temporarily connect a jumper between eyelets 1 and 2 on each circuit board). If the hum and noise become virtually inaudible, the amplifier is probably working properly, and the cause should be sought elsewhere in the system. If plainly audible hum or noise persist, there may be an error or defective component in the power supply, or an open ground connection. If the hum is in one channel of the amplifier only, check to see that eyelet #2 of its circuit board is soldered to the input ground lug. Occasionally, a bad tube will cause this condition, which is easily determined by switching tubes until the hum appears in opposite channel. Hum on both channels is probably due to a power supply defect, a bad capacitor section or defective diode.

Intermittent hum, noise or silence are usually the result of a poor solder connection. If the trouble occurs in both channels, check the power supply first; if in one channel alone, examine the solder connections on that side.

Filament glow is normal, but if the plate (the large metal area) of a tube tends to glow red, either the tube or its associated circuitry is faulty. If all four of the output tubes glow in this manner, there is a short circuit in either the cathode (pin #3 of any 6BQ5) or filament (pin #4 and #5), or at lug #4 of the filter capacitor.

The voltage chart printed alongside the schematic diagram may be helpful in trouble-shooting. If readings made at any of the points indicated differ from those listed by more than 10%, it is likely that a wiring error or defective component is nearby in the circuit.

The Stereo 35 should never be operated with any of its tubes removed from their sockets.

## FACTORY SERVICE AND WARRANTY

The Stereo 35 is designed to provide reliable, trouble-free performance for a long period of time when properly assembled and installed. It is intended for use with the 120-volt a.c. power supplied to most homes. Although variations of several volts above or below this figure will have no pronounced effect upon performance or component life, the normal guarantee on the equipment is not applicable if it is operated with a.c. inputs greater than 130 volts. If your local power is this high or higher in voltage, it is suggested that a voltage regulating or adjusting device be installed to protect the amplifier.

All parts used in the Stereo 35 are guaranteed for a period of one year from the date of purchase except tubes, which carry the standard electronic industry (EIA) 90-day warranty. Defective parts will be replaced at no charge if they are returned prepaid to the factory either directly or via the dealer from whom the kit was purchased. Many Dynakit dealers carry parts in stock which may be used for replacements. After the guarantee period has passed, Dynaco, Inc. will supply any non-standard parts used at net prices. Parts which are standard (resistors, capacitors, tubes) can generally be purchased from a local electronics supply store.

If it is believed that a transformer is defective, it should be disconnected by unsoldering, never by cutting its leads so short that it cannot be re-used.

If the kit has been completely assembled, yet cannot be made to function properly, or if difficulty is apparent after a short period of use, we will service the kit for a fixed charge of \$6.00, plus the cost of the parts which are outside the warranty or have been damaged by the user.

Factory assembled amplifier include a one-year warranty on labour as well as parts.

**IMPORTANT: FIXED-CHARGE SERVICE AND MAINTENANCE ARE NOT AVAILABLE FOR KITS WHICH ARE INCOMPLETELY WIRED, OR KITS WIRED WITH SOLDER OTHER THAN ROSIN CORE TYPE, OR KITS PHYSICALLY OR ELECTRICALLY MODIFIED WITHOUT PRIOR FACTORY AUTHORIZATION. ADDITIONALLY, NO PARTS WILL BE REPLACED AND NO SERVICE MADE AVAILABLE FOR KITS FOR WHICH THE WARRANTY POST CARD HAS NOT BEEN RETURNED. THE SERIAL NUMBER ON THE FRONT COVER OF THIS INSTRUCTIONS BOOK MUST BE MENTIONED IN ALL CORRESPONDENCE AND IN ANY CASE WHERE PARTS ARE RETURNED, OR KITS SENT OR BROUGHT TO THE FACTORY FOR SERVICE.**

It is the factory prerogative to limit the service facility to one year from the date of purchase.

When shipping the amplifier to Dynaco, Inc., for service, attach a note specifying the symptoms, the name and address of the sender, and the serial number of the kits. The kit should be securely packed to withstand the abuses of handling in transit. It should be placed in a rugged carton surrounded by several inches of shredded paper or other soft packing material. *The original kit carton is not suitable for shipment of a wired amplifier.*

Shipment should be made by prepaid EXPRESS, where possible, repaired kits will then be returned EXPRESS C:O:D: for freight and service charges (unless these charges have been prepaid). Parcel post is not a safe method for the shipment of assembled kits, and should not be used for this purpose.

The Dyna Company assumes no liability or responsibility for damages or injuries sustained in assembly or operation of this Dynakit.

## STEREO 35 PART LIST

- 1 Chassis set (chassis, cover and bottom plate)
- 1 Power Transformer PA-774
- 2 Output Transformers Z-565
- 4 Output Tubes 6BQ5/EL84/7189
- 2 Driver Tubes 7247
- 2 Rectifier Diodes 500 ma 1000 PIV (Silicon)
- 1 Quadruple Section Filter Capacitor 60/40/20 @450 v.; 100 @ 25v.
- 2 3-Screw Terminal Strips
- 1 Fuse Holder with Rubber Washer and Circular Nut

- 1 5-Lug Terminal Strip
- 1 Fuse 2-Ampere Slo-Blo
- 1 Line Cord with Plug
- 2 Input Sockets
- 1 Roll Hookup Wire
- 2 PC-13 Circuit Board Assemblies

### RESISTORS

- 1 50 ohms, 5 watts
- 1 95 ohms, 5 watts
- 1 6,800 ohms (blue-gray-red), 1 watt

### HARDWARE

- 4 Rubber Feet
- 1 1/2" Grommet
- 12 8/32 x 1/4" Machines Screws
- 12 8/32 Nuts
- 12 #B Lockwashers
- 25 4/40 x 1/4" Machine Screws
- 25 4/40 Nuts
- 25 #4 Lockwashers
- 4 #6 Sheet Metal Screws
- 1 Instruction Manual with Pictorial Diagrams
- 1 Warranty Card

**SCHEMATIC DIAGRAM**

**LEFT CHANNEL  
PC-13**

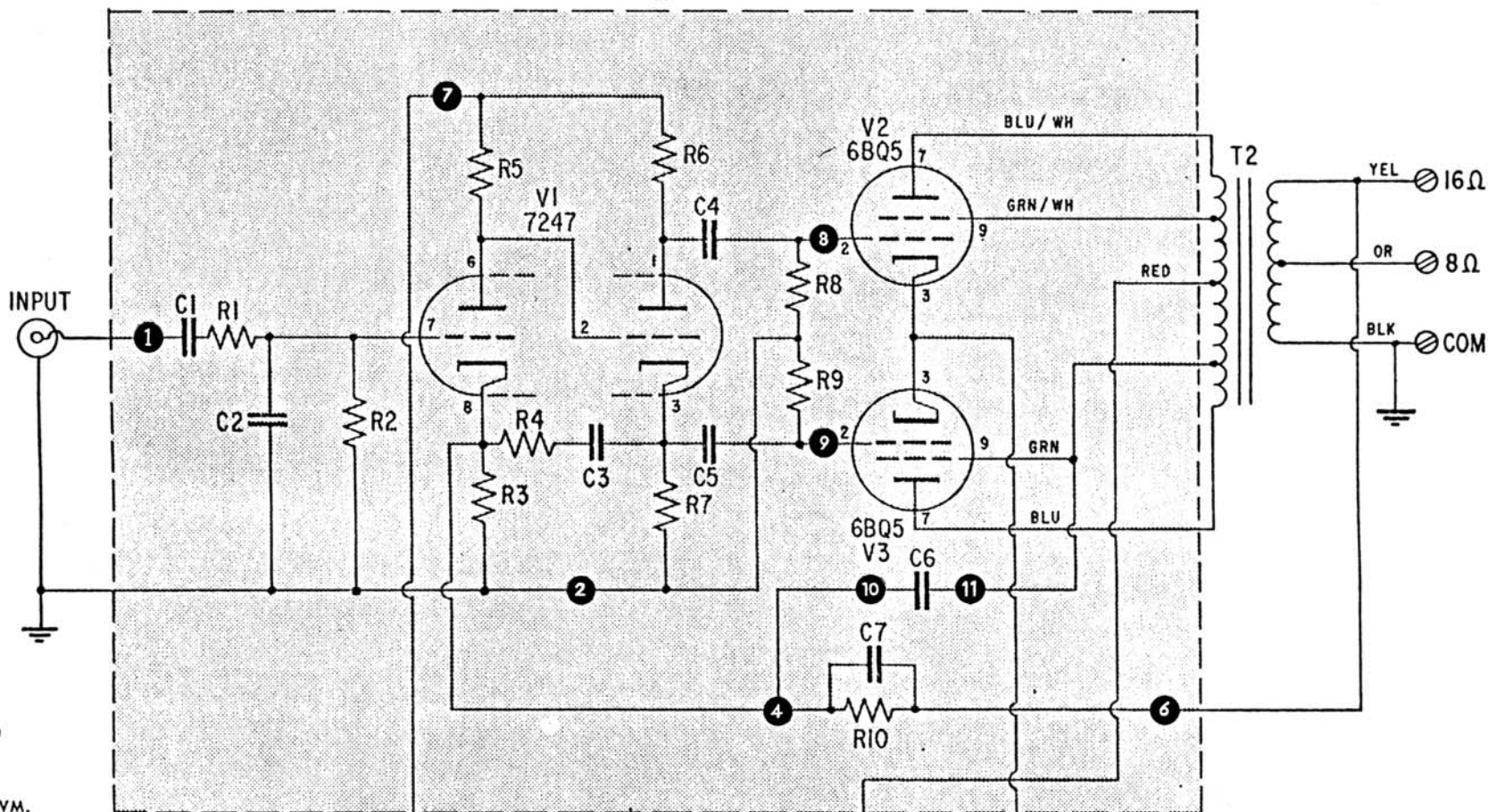

Voltages shown measured from tube pin to chassis with VTVM.

**VOLTAGE CHART**

PIN	V-1	V-2	V-3	V-4	V-5	V-6
1	215	0*	0*	230	0*	0*
2	112	0	0	112	0	0
3	116	13.5	13.5	116	13.5	13.5
4	485 TO 9	6.3AC	6.3AC	485 TO 9	6.3AC	6.3AC
5	6.3AC			6.3AC		
6	112	0*	0*	112	0*	0*
7	0	370	370	0	370	370
8	.85	0*	0*	.85	0*	0*
		375	375		375	375

385	380	320	13.5
-----	-----	-----	------

\* Unused pins may have internal connections, therefore some tubes (depending on brand), may have voltages appear at these points.

**RIGHT CHANNEL  
PC-13**

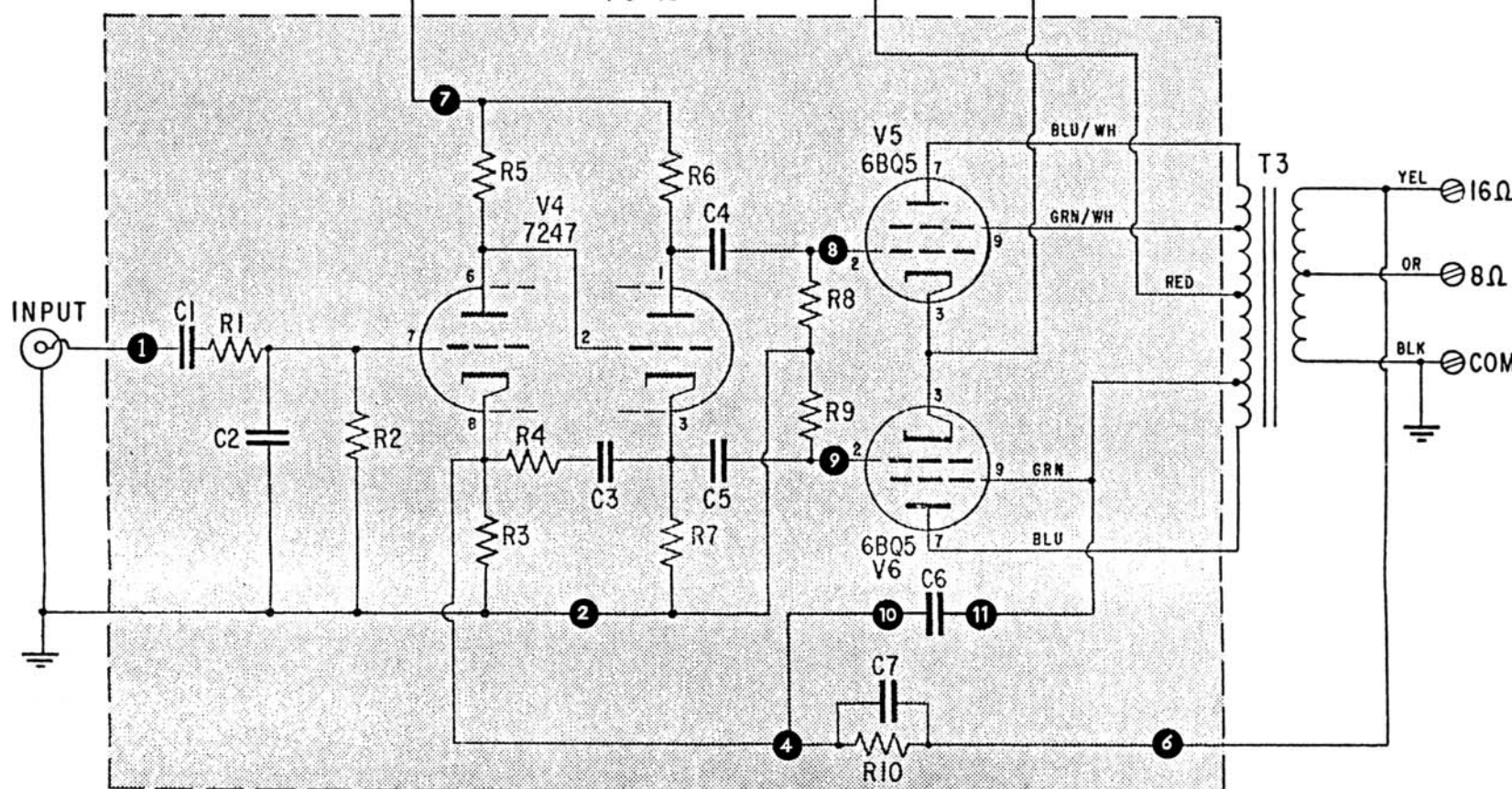

● denotes eyelets

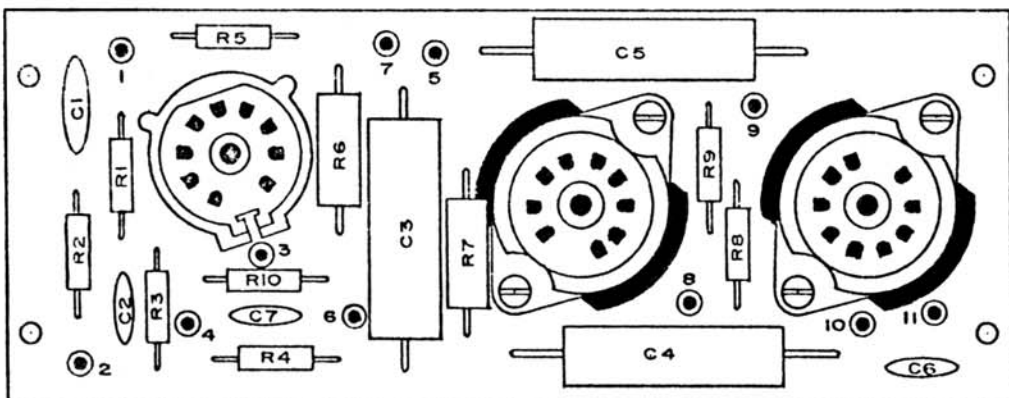

**PARTS LIST FOR SCHEMATIC DIAGRAM**

Parts marked (\*) are mounted on circuit board PC-13

**RESISTORS**

Part	Value	Power	Tolerance	Color Code
R 1*	47K	1/2W	10%	yellow, violet, orange
R 2*	470K	1/2W	10%	yellow, violet, yellow
R 3*	1.3K	1/2W	5%	brown, orange, red
R 4*	150K	1/2W	5%	brown, green, yellow
R 5*	300K	1/2W	5%	orange, black, yellow
R 6*	27K	1W	5%	red, violet, orange
R 7*	33K	1W	5%	orange, orange, orange
R 8*	470K	1/2W	10%	yellow, violet, yellow
R 9*	470K	1/2W	10%	yellow, violet, yellow
R 10*	27K	1/2W	5%	red, violet, orange
R 11	6.8K	1W	10%	blue, gray, red
R 12	50	5W	10%	
R 13	95	5W	5%	

**CAPACITORS**

Part	Value	Voltage
C 1*	.1 mfd	3 V
C 2*	33 pf	500 V
C 3*	.22 mfd	200 V
C 4*	.1 mfd	400 V
C 5*	.1 mfd	400 V
C 6*	18 pf	500 V
C 7*	27 pf	500 V
C 8A	60 mfd	450 V
C 8B	40 mfd	450 V
C 8C	20 mfd	450 V
C 8D	100 mfd	25 V

T 1 Power Transformer PA-774

T 2 Output Transformer Z-565

T 3 Output Transformer Z-565

D 1 Silicon Rectifier Diode, 500 ma 1000 PIV

D 2 Silicon Rectifier Diode, 500 ma 1000 PIV

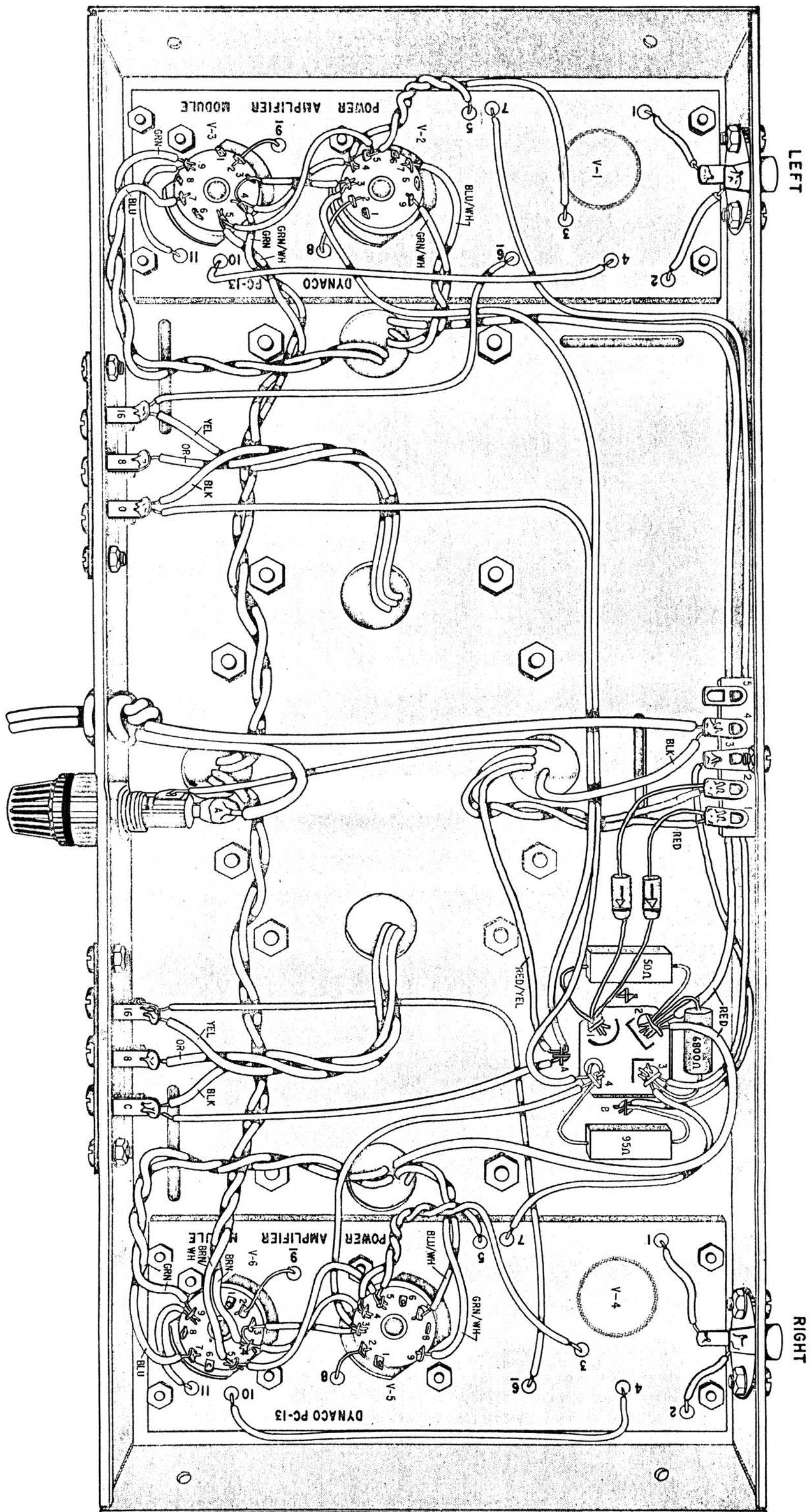

## Free Manuals Download Website

<http://myh66.com>

<http://usermanuals.us>

<http://www.somanuals.com>

<http://www.4manuals.cc>

<http://www.manual-lib.com>

<http://www.404manual.com>

<http://www.luxmanual.com>

<http://aubethermostatmanual.com>

Golf course search by state

<http://golfingnear.com>

Email search by domain

<http://emailbydomain.com>

Auto manuals search

<http://auto.somanuals.com>

TV manuals search

<http://tv.somanuals.com>