

System 2.5

Home Theater Speaker Set



Congratulations on your purchase and welcome to the AudioSource family of satisfied customers. Please take a few moments to read this manual before you get started. Also, be sure to retain this document should you need to refer to it in the future.

The AudioSource System 2.5 Home Theater Speaker System contains four LS2 Compact Speakers (left front, right front, left surround & right surround); one LS2C Center Speaker; and one SW 80 Powered Subwoofer. This system is designed to reproduce high fidelity music, including digital signals. Movies and stereo TV broadcasts will sound more realistic, putting you in the center of the action. The LS2C center channel speaker is video-shielded, allowing placement on top of your television. LS2 speakers are provided for both the front and surround channels, to provide a theater-like experience.

This manual is divided into two sections. The first provides information about the LS2 and LS2C speakers. The next section concerns the SW 80 Powered Subwoofer.

If you need more information, we offer friendly, toll-free assistance at 1.800.HELP.115 (1.800.435.7115). You may also fax us 24 hours a day at 650.348.8083.

If any parts of this system are missing or damaged, do not return to the store where you purchased this system. Please call AudioSource directly at 800-HELP-115 (800-435-7115).

LS2 & LS2C

Speaker Placement

The center channel speaker should be placed as close as possible to the TV, preferably either directly on top of or below it. This locks the sound to the picture. Place the front speakers near the front corners of the room, either on a bookshelf or wall-mounted. Positioning near a corner enhances bass performance. Place the surround speakers either to the side of, or behind, your listening position. Typical placement is on the side walls, slightly above ear level, about two-thirds of the way back from the front of the room. This allows the surround speakers to aim directly at the listener, placing you in the middle of a five-speaker sound field.

Speaker Mounting

The LS2 speakers include *U-shaped* brackets to mount the speakers to the wall. For safety, always mount these speakers on a wall that is reinforced from behind. *Never mount a speaker on a wall made of unreinforced drywall or plasterboard.* If you are unsure, consult a professional contractor. These speakers can also be placed on bookshelves and most types of speaker stands.

Hooking Them Up

The five-way binding posts accommodate nearly any type of connector and up to 14-gauge wire. For bare wire, press the binding post in to reveal the eye, thread the wire into the eye, and release the spring-loaded connector. For banana plugs, simply insert the plug into the end of the connector.

When connecting the speakers, be sure to retain the correct polarity. Attach the wire from the +, red, or positive terminal on one component to the +, red, or positive terminal on the corresponding component's speaker output terminals. The -, black or negative terminals must connect to the respective -, black or negative terminals. This is easy to do by observing the color, stripe, or ribbing that appears on the wire.

1. Connect the left front speaker terminals (+/-) of your receiver to the left LS2 front speaker.
2. Connect the right front speaker terminals (+/-) of your receiver to the right LS2 front speaker.
3. Connect the left surround speaker terminals (+/-) of your receiver to the left LS2 rear surround speaker.
4. Connect the right surround speaker terminals (+/-) of your receiver to the right LS2 rear surround speaker.

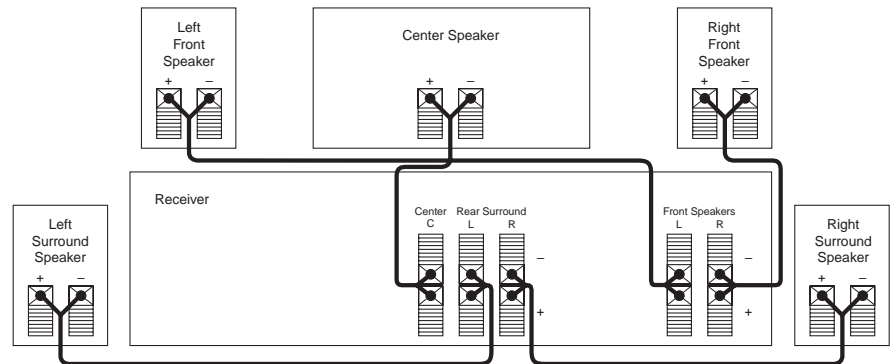

5. Connect the center channel speaker terminals (+/-) of your receiver to the LS2C center channel speaker.

Note: If you are using an outboard Dolby® Surround Processor, the speaker terminals for the center and rear/surround speakers will be found on this component, not on your receiver.

SW 80 Powered Subwoofer

Subwoofers extend the bass response of your system beyond the limitations of most speakers. They are used with, not in place of, your existing left and right speakers. A subwoofer can dramatically enhance a stereo TV, a stereo system, or a full fledged home theater.

Features of the SW 80

The AudioSource SW 80 features a highly efficient ported enclosure, a rugged 8-inch reinforced driver and a eighty-watt amplifier with a passive low frequency crossover network. A line level input is provided for fast and easy connection to virtually any system.

Using the Controls

Power

The power switch has two positions: off and on. When the power LED is lit, the power is on.

Level

The level control adjusts the volume of the SW 80. Once set, the level control should not require further adjustment. Begin with the level control at the minimum position. Slowly increase the level until you can hear the subwoofer. A subwoofer playing too loud can give your system a muddy sound, so be sure to balance the subwoofer carefully with your other speakers. Output level is relative and can be different from location to location. Always return to the normal listening location to evaluate any setting changes.

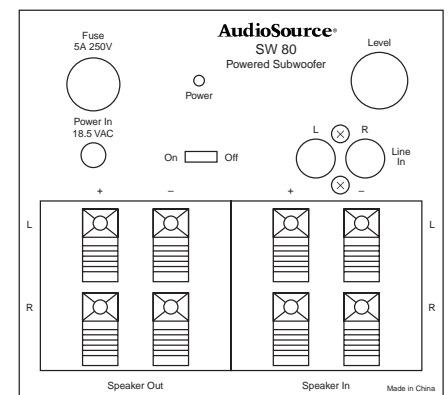

Placement Guidelines

Prior to installing your new subwoofer, please consider the following guidelines. Placing the subwoofer near a wall or in a corner will greatly increase its bass response. As frequencies reproduced by subwoofers are long and need room to propagate, a subwoofer placed near the listening position will not sound as full as one placed farther away. Please be careful about placing anything directly on top of your subwoofer, as the vibrations of the speaker cabinet could cause these items to shake loose or fall.

Connecting the SW 80

The diagrams on the following page show four of the most common types of subwoofer connections. This information will guide you through the connection process.

All signals into your unit will first pass through the crossover. The portion of the signal below the current crossover frequency setting will be reproduced by the subwoofer. The unprocessed signal will also be passed to the hi and line level outputs. If you have a choice of connection options, remember that it may be easier to run long distances with speaker wire than with line connectors.

Hi Level In

These inputs are designed to accept an amplified signal from the speaker outputs of a receiver, power amp or other device not equipped with line level outputs.

Hi Level Out

The original amplified signal from your source is present at these outputs, for connection to the existing left and right speakers.

Line In

The RCA-type jack of your SW 80 is designed to accept a line level signal from a receiver, pre-amp, surround sound decoder, television or similar device. When using a single line level output from another unit, a Y connector should be used to send the signal to both the left and right inputs.

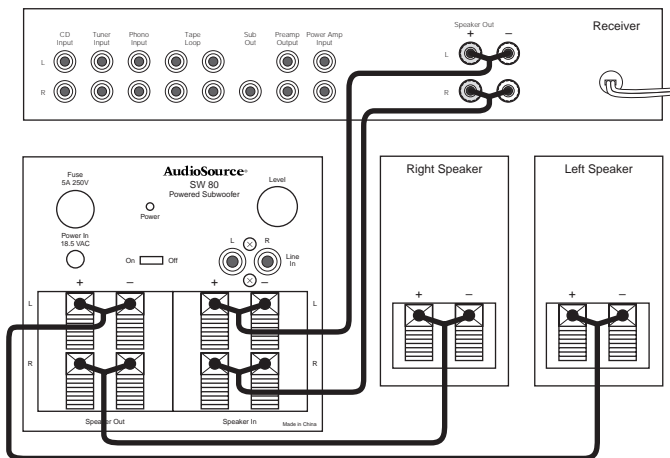

Hi Level Connections

Here the signal is already amplified as it leaves the receiver/amplifier. The speaker terminals of this unit are connected to the hi level inputs of the SW 80. The left and right speakers receive the original amplified signal from the SW 80 hi level outputs.

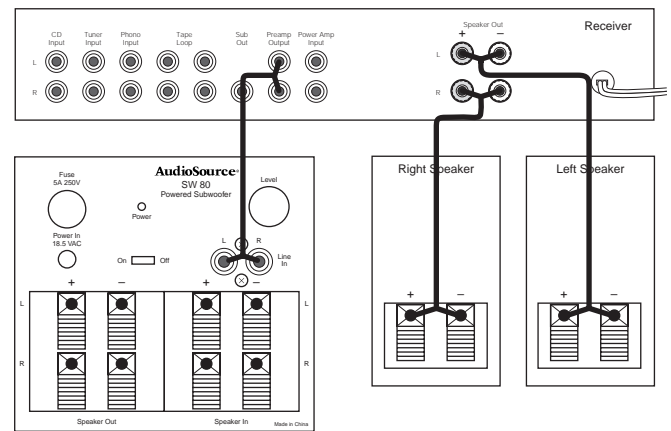

Line Level Connections

In this example, the pre-amp outputs of a stereo receiver are connected to the SW 80 line inputs. The line outputs on the SW 80 return the line level signal to the power amp inputs on the stereo receiver, which in turn powers the left and right speakers.

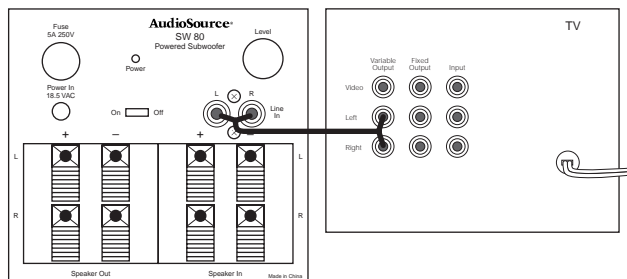

Television Enhancement

Many newer television sets are equipped with variable stereo outputs. The signal available at these outputs varies with the television volume. In this situation, these variable audio outputs can be connected directly to the SW 80 line inputs to enhance the bass response of the television's built-in speakers.

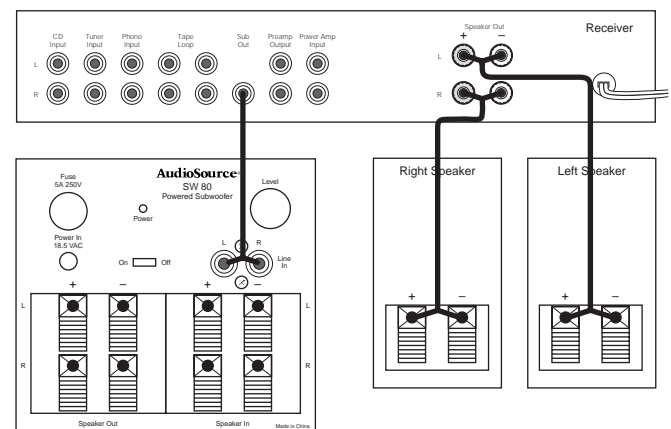

Dedicated Subwoofer Connections

Many surround sound decoders, home theater processors and audio/video receivers are equipped with a dedicated subwoofer line output. In this case, the signal is already processed and does not need to return to the system or other speakers. Connect this line output to the line inputs of the SW 80. A Y connector should be used to feed this single output to both the left and the right line inputs.

Safety Instructions

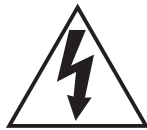

Warning: To reduce the risk of fire or electric shock, do not expose this appliance to rain or moisture.

Caution: To reduce the risk of electric shock, do not remove cover (or back); no user serviceable parts inside. Refer servicing to qualified service personnel.

Caution: To prevent electric shock, match wide blade of plug to wide slot, fully insert.

Attention: Pour éviter les chocs électriques, introduire la lame la plus large de la fiche dans la borne correspondante de la prise et pousser jusqu'au fond.

The lightning flash with arrowhead symbol, within an equilateral triangle, is intended to alert the user to the presence of uninsulated dangerous voltage within the product's enclosure that may be of sufficient magnitude to constitute a risk of electrical shock to persons. The exclamation point within an equilateral triangle is intended to alert the user to the presence of important operating and maintenance (servicing) instructions in the literature accompanying the appliance.

Read Instructions

All the safety and operating instructions should be read before the appliance is operated.

Retain Instructions

The safety and operating instructions should be adhered to.

Heed Warnings

All warnings on the appliance and in the operating instructions should be adhered to.

Follow Instructions

All operating and use instructions should be followed.

Water and Moisture

The appliance should not be used near water. For example, near a bathtub, washbowl, kitchen sink, laundry tub, in a wet basement, or near a swimming pool, etc.

Ventilation

The appliance should be situated so that its location or position does not interfere with its proper ventilation. For example, the appliance should not be situated on a bed, sofa, rug, or similar surface that may block the ventilation openings; or, placed in a built-in situation, such as a bookcase or cabinet that may impede the flow of air through the ventilation openings.

Heat

The appliance should be situated away from heat sources such as radiators, heat registers, stoves, or other appliances (including amplifiers) that produce heat.

Power Sources

The appliance should be connected to a power supply only of the type described in the operating instructions or as marked on the appliance.

Grounding or Polarization

Precautions should be taken so that the grounding or polarization means of an appliance is not defeated.

Power Cord Protection

Power supply cords should be routed so that they are not likely to be walked on or pinched by items placed on or against them, paying particular attention to cords at plugs, convenience receptacles, and the point where they exit from the appliance.

Cleaning

The speaker should be cleaned only as recommended by the manufacturer.

Power Lines

An outdoor antenna should be located away from power lines.

Non-Use Periods

The power cord of the appliance should be unplugged from the outlet when left unused for a long period of time.

Object and Liquid Entry

Care should be taken so that objects do not fall and liquids are not spilled into the enclosure through openings.

Damage Requiring Service

The appliance should be serviced by qualified service personnel when: **a)** the power supply cord or the plug has been damaged; **b)** objects have fallen, or liquid has been spilled into the appliance; **c)** the appliance has been exposed to rain; **d)** the appliance does not appear to operate normally or exhibits a marked change in performance; or **e)** the appliance has been dropped, or the enclosure damaged.

Servicing

The user should not attempt to service the appliance beyond that described in the operating instructions. All other servicing should be referred to qualified service personnel.

Product Servicing

In the event your System 2.5 fails to operate properly, please contact the dealer where you purchased the unit. Or you may contact AudioSource directly for further assistance.

SW 80 Powered Subwoofer Specifications

Amplifier 80 watts
Frequency Response 30 Hz - 250 Hz
Driver 8" Reinforced
Functions Power (On, Off)

Inputs Hi Level (Speaker), Line (RCA)
Output Hi Level (Speaker)
Dimensions 13½" x 11¼" x 11¼"

LS2 Front and Surround Speaker Specifications

Power Handling 100 watts
Frequency Response 80 Hz - 20 kHz
Impedance 8 ohms
Sensitivity 87 dB
Woofer 4" polypropylene
Tweeter ¾" polycarbonate dome
Connections Spring-loaded clips
Dimensions 8⅞" x 5⅞" x 4¼"

LS2C Center Speaker Specifications

High Intensity Video Shielding
Power Handling 100 watts
Frequency Response 80 Hz - 20 kHz
Impedance 8 ohms
Sensitivity 87 dB
Woofer Two 4" polypropylene
Tweeter ¾" polycarbonate dome
Connections Spring-loaded clips
Dimensions 5⅞" x 17¼" x 5½"

Design and specifications are subject to change without notice.



9300 North Decatur
portland, Or 97203
Tel. 503.286.9300
Fax 503.978.3302
audiosource@phoenixgold.com
www.audiosource.net

Printed in China
© 2000 AudioSource, Inc.

Free Manuals Download Website

<http://myh66.com>

<http://usermanuals.us>

<http://www.somanuals.com>

<http://www.4manuals.cc>

<http://www.manual-lib.com>

<http://www.404manual.com>

<http://www.luxmanual.com>

<http://aubethermostatmanual.com>

Golf course search by state

<http://golfingnear.com>

Email search by domain

<http://emailbydomain.com>

Auto manuals search

<http://auto.somanuals.com>

TV manuals search

<http://tv.somanuals.com>