



**Model CCDLF
License Plate Rearview Camera
with Non-Reversed Image**









CCDLF FEATURES:



- Built Into License Plate Frame
- High Resolution, 1/3" CCD Color Camera
- Compact Zinc Alloy Die Cast Body
- Waterproof Housing
- Waterproof Microphone
- 150° Wide Angle View
- Non-Reversed Image

128-7729
1 of 8

CONTENTS

ITEM	FIGURE	QUANTITY
LICENSE PLATE WITH NON REVERSED CAMERA		1
CAMERA ANGLE ADJUSTMENT WEDGE		1
THEFT-PROOF SCREWS		2
THEFT-PROOF SCREWS		2
FUSE (1A)		1
CAMERA MOUNTING BOLT		2
ANTI-THEFT ALLEN KEY		1
EXTENSION CABLE		1
DIELECTRIC GREASE PACKET		1
HEAT SHRINK TUBING		1

Color Camera View:



Cable Connector End View:

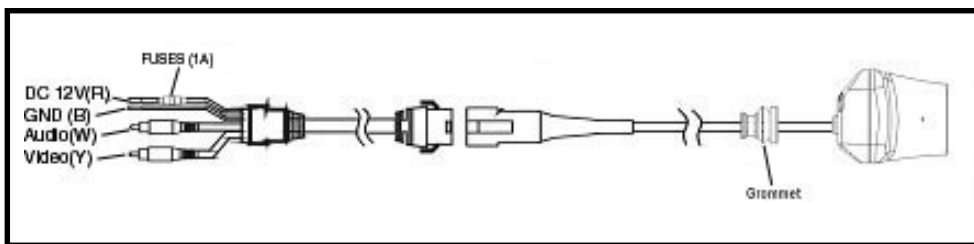

The CCDLF camera has a non-reversed image. This camera can be used with Audiovox LCD rear view mirrors and the LCM45NB. It can also be used with multimedia systems that reverse the backup camera image.

Installation.

1. Locate suitable location near the vehicles rear license plate to route the camera cable. The camera cable can be routed through an existing grommet or use a location where a 5/8" hole can be drilled. Be sure to check behind intended drilling location. Check for camera interference with license plate lights, hatch release switch and/or mechanism.
2. Remove the screws holding the rear license plate to the vehicle and remove plate.
3. Place the license plate into the camera license plate frame. If routing camera cable into vehicle behind license plate, drill a 5/8-inch hole at selected location. Coat edge of hole with rust preventative. Then route the camera cable connector through the hole and insert grommet into hole. Place the license plate against vehicle and line up the mounting screw holes. Using the black screws provide, tighten the screws with the anti-theft tool provided. Pull gently on the camera cable to remove slack.
4. If routing camera cable into vehicle above license plate, remove license plate light valence. Drill a 5/8-inch hole at selected location. Coat edge of hole with rust preventative. Then route the camera cable through the hole and insert grommet into hole. Place the license plate against vehicle and line up the mounting screw holes. Using the black screws provide, tighten the screws with the anti-theft tool provided. Pull gently on the camera cable to remove slack.

If using Audiovox LCD rearview mirror or LCM45NB, use the extension cable supplied with the monitor.

5. Connect the Camera cable to the extension cable (supplied). Route the extension cable up to the intended monitor. Connect as follows:
 - a. Black wire- connect to chassis ground
 - b. Red wire- connect to 12V accessory wire
 - c. Yellow RCA- connect to Video input
 - d. Red RCA- connect to audio input (if equipped)

When the connection of the Camera and Extension Cable is outside of the vehicle, (such as a Pickup Truck Application), prior to making the connection, coat the male and female terminals with the Dielectric grease supplied. Slide the packaged pre-sized heat shrink tube over both connectors and shrink using a heat gun to ensure a watertight connection.

View angle adjustment:

This camera frame is designed for universal application. The angle of the image of the installed frame might have to be adjusted depending on the license plate mounting angle. There is a 10-degree angle adjustment wedge supplied to change the downward angle from 40 degrees to either 30 or 50 degrees. The angle wedge goes between the camera frame and camera body. Longer camera mounting screws are provided for use with the angle wedge.

1. Turn on monitor and look at back up camera image. You should be able to see a small portion of the vehicles bumper.

2. If you see too much bumper, the downward angle must be decreased. Place the thin edge of the wedge on top between the camera and frame.
3. If you cannot see the bumper at all, the downward angle must be increased. Place the thin edge of the wedge on the bottom between the camera and frame.

Camera Installation

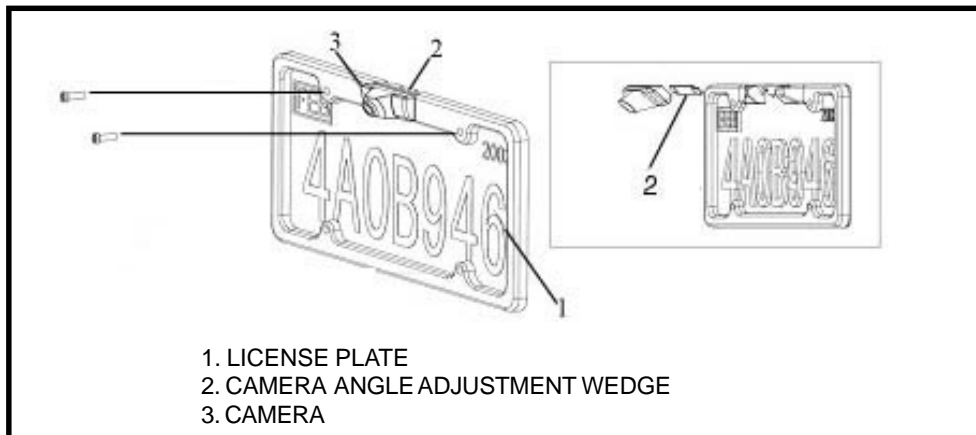

Specifications:

1. Image Device : 1/3" CCD with 10 Bit A/D Digital Signal Processor.
2. Signal System: CCDLF NTSC, Standard image.
3. Total Effective Pixels: NTSC:537(H)*505(V).
4. Resolution: Greater than 250,000 pixels Greater than 420 TV Lines.
5. Power source : DC12V
6. Video Output:1.0Vp-p Composite(75 ohm load).
7. Low Lux Sensitivity :0.2 Lux
8. S/N Ratio : More than 48db.
9. Current: 80mA
10. Operating Temperature: -13° F to 158° F (-25° C to 70° C)
11. Wide Angle View : Diagonal 150° (natural state lens declination 40 degrees)
12. Camera Outer Dimensions: 25mm(w) x 30mm(H) x 62mm(D)



For Customer Service
Visit Our Website At
www.audiovox.com
Product Information, Photos,
FAQ's Owner's Manuals

© 2006 Audiovox Electronics Corp., 150 Marcus Blvd., Hauppauge, N.Y. 11788

128-7729

Free Manuals Download Website

<http://myh66.com>

<http://usermanuals.us>

<http://www.somanuals.com>

<http://www.4manuals.cc>

<http://www.manual-lib.com>

<http://www.404manual.com>

<http://www.luxmanual.com>

<http://aubethermostatmanual.com>

Golf course search by state

<http://golfingnear.com>

Email search by domain

<http://emailbydomain.com>

Auto manuals search

<http://auto.somanuals.com>

TV manuals search

<http://tv.somanuals.com>