

RAMPAGETM
BY AUDIOVOX

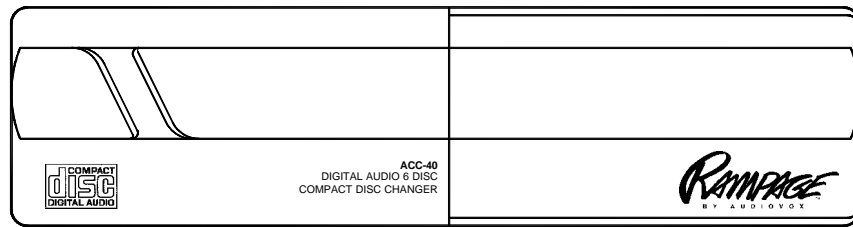

**MODEL ACC-40
6-DISC CD CHANGER
WITH WIRED COMMANDER**



INSTALLATION MANUAL

PACKING LIST

MAIN UNIT

CD Changer

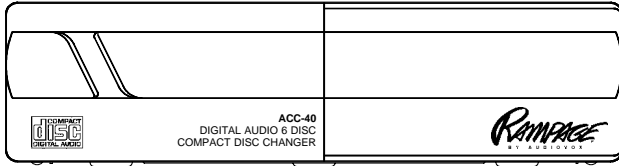

Wired Commander

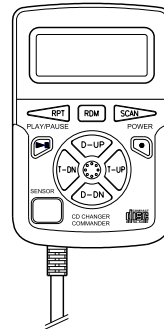

FM Modulator

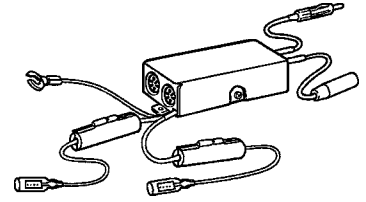

INSTALLATION PARTS

Mounting Bracket

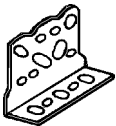

2 pcs.

Hex Head Bolt with Washer Base (M5 x 12)



4 pcs.

Phillips Head Screw (Large)



4 pcs.

Phillips Head Screw (Small)



2 pcs.

Mounting Angle Adjustment Tool



1 pc.

Screw Hole Cover Labels

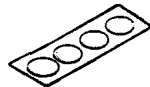

1 pc.

5 Meter Din Cable

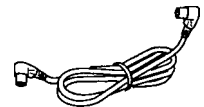

1 pc.

ACCESSORIES

CD Magazine

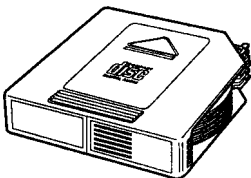

1 pc.

Index seal sheet

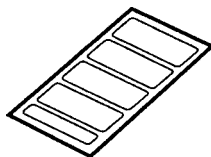

1 pc.

Installation Manual

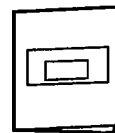

1 pc.

Owner's guide

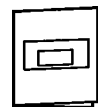

1 pc.

BEFORE INSTALLING THE UNIT

Transport Lock Screws

The mechanism in the CD changer is "locked" into place during shipment by the 4 transport screws. Be sure to remove the screws prior to installation. Retain these screws for future use when transporting the unit for service/maintenance.

● Caution ●

After removing the transport lock screws, place the supplied seals over the screw holes. These seals are used to keep dust out of the unit, which could cause a malfunction.

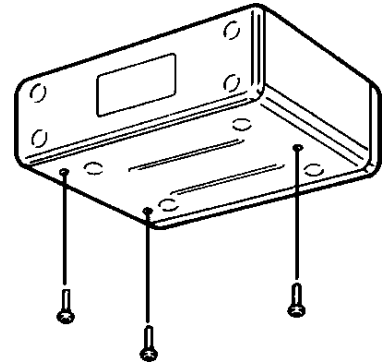

Installation and Wiring Precautions

- 1 To prevent a short-circuit,
 - Be sure to turn off the ignition and remove the negative (-) battery cable, prior to installation.
 - Connect power wires last.

Note

If the changer is to be installed in a car that is equipped with an on-board drive or navigation computer, do not disconnect the battery cable. If the cable is disconnected, the computer memory may be lost. Under these conditions, use extra caution during installation, not to cause a short circuit.

- 2 Do not install the unit in the following locations.
 - Locations exposed to direct sunlight.
 - Where hot air is discharged from the car heater.
 - In areas subject to extreme temperatures.

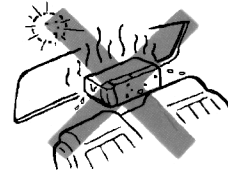

- 3 Incorrect installation can cause the sound to "skip" when playing a disc. Mount the unit firmly in place, using the supplied brackets and screws.

- 4 Be careful not to damage the car wiring.

- 5
 - Be sure to use the supplied screws.
 - Be careful not to snag any wires when tightening screws.
 - Do not use any of the screws that are part of the brake or steering system, to install the unit.

- 6
 - This unit cannot be installed on its side, end, or upside down. Installation in such positions will cause malfunctioning of the mechanism.

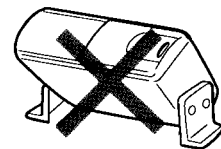
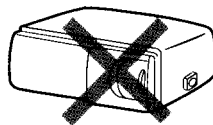
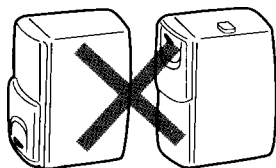

INSTALLATION

The unit can be installed horizontally, vertically or at a 45° angle. The position of the built-in anti-vibration springs (left and right side), must correspond to the mounting position chosen. If the springs are not set correctly for the type of installation chosen, the anti-vibration compensation will not be effective and vibration may cause the disc to skip.

HORIZONTAL INSTALLATION

Set the anti-vibration springs to position "H".

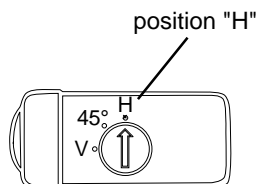

VERTICAL INSTALLATION

Set the anti-vibration springs to position "V".

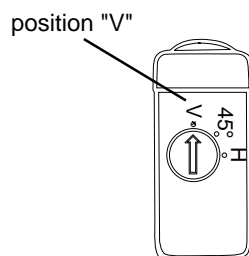

45° ANGLE INSTALLATION

Set the anti-vibration springs to position "45°".

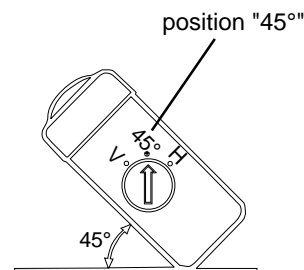

PROCEDURE FOR HORIZONTAL INSTALLATION

- 1 Attach a mounting bracket to each side of the unit, using the 4 hex head bolts with washer base.

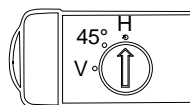

NOTE: Make sure anti-vibration springs are set to position "H".

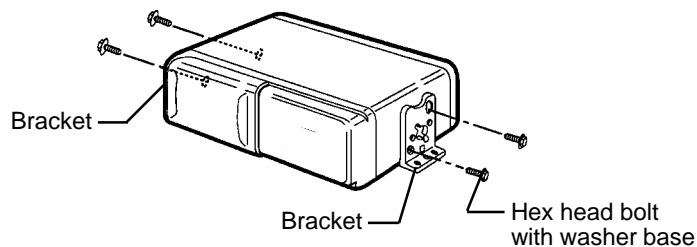

- 2 Determine the mounting location, and drill four mounting holes.

NOTE: If mounting surface is carpeted, use caution when drilling holes to prevent drill bit from catching on carpet. Cut holes in carpet before drilling into sub-surface.

Never mount the unit near the fuel tank.

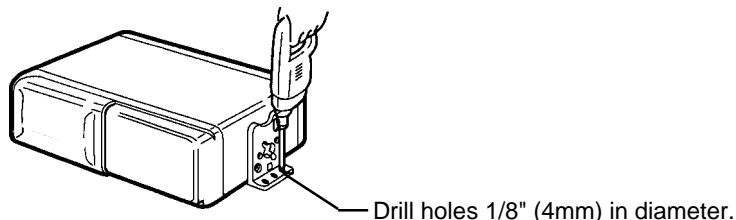

- 3 Secure the unit in place, using four large self-tapping Phillips head screws. Use RTV (silicone sealer) on screw threads or around the holes to prevent moisture intrusion.

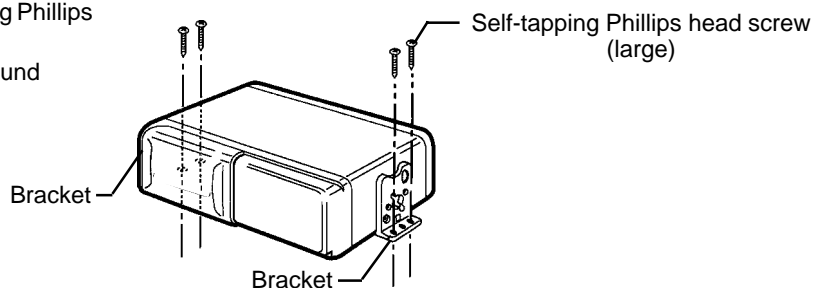

PROCEDURE FOR VERTICAL INSTALLATION

Note

If the anti-vibration spring position has been changed and verified for vertical mounting (as shown on page 3), start with step 2.

- 1** Set the anti-vibration springs to position "V".

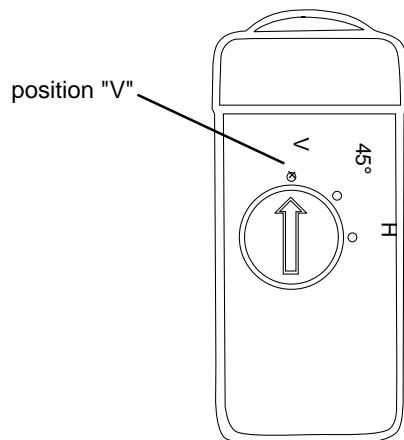

- 2** Attach a mounting bracket to each side of the unit, using the hex head bolts with washer base.

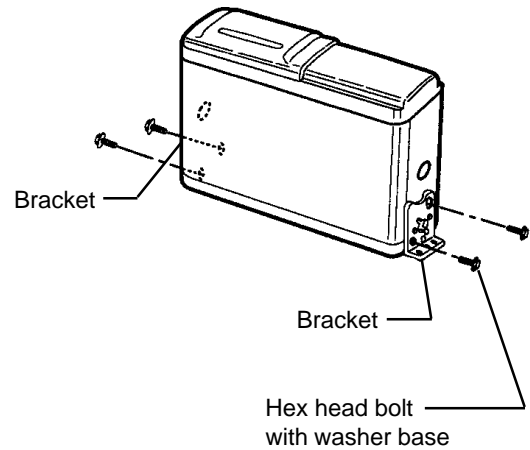

- 3** Determine the mounting location, and drill four mounting holes.

NOTE: If mounting surface is carpeted, use caution when drilling holes to prevent drill bit from catching on carpet. Cut holes in carpet before drilling into sub-surface.

Never mount the unit near the fuel tank.

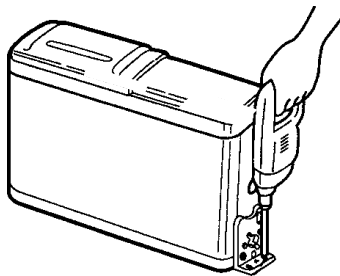

Drill holes 1/8" (4mm) in diameter

- 4** Mount the unit in place, using four large self-tapping Phillips head screws. Use RTV (silicone sealer) on screw threads or around the holes to prevent moisture intrusion.

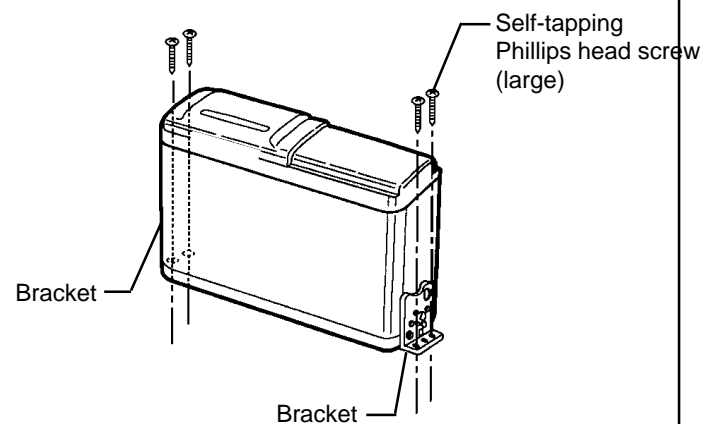

PROCEDURE FOR 45° ANGLE INSTALLATION

Note
If the anti-vibration spring position has been changed and verified for 45° angle mounting (as shown on page 3), start with step 2.

1 Set the anti-vibration springs to position "45°".

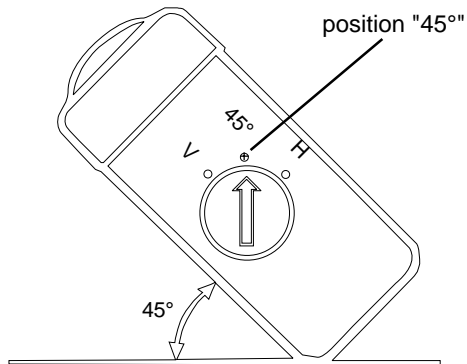

2 Attach a mounting bracket to each side of the unit, using the 4 hex head bolts with washer base.

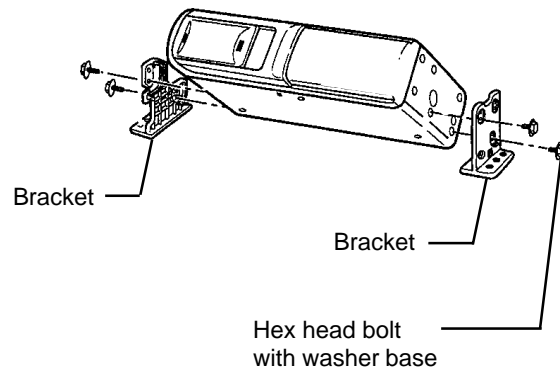

3 Determine the mounting location, and drill four mounting holes.

NOTE: If mounting surface is carpeted, use caution when drilling holes to prevent drill bit from catching on carpet. Cut holes in carpet before drilling into sub-surface.

Never mount the unit near the fuel tank.

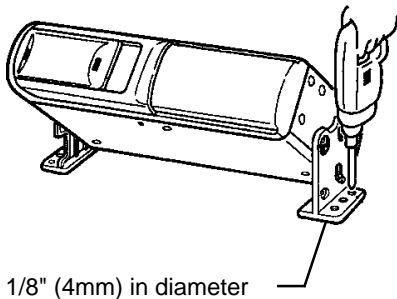

4 Mount the unit in place, using four large self-tapping Phillips head screws.

Use RTV (silicone sealer) on screw threads or around the holes to prevent moisture intrusion.

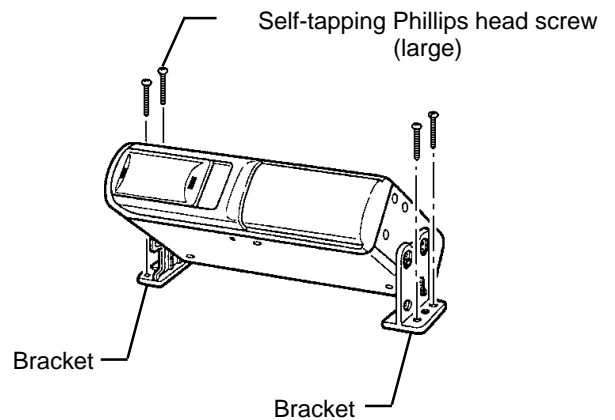

SYSTEM WIRING AND ADJUSTMENT

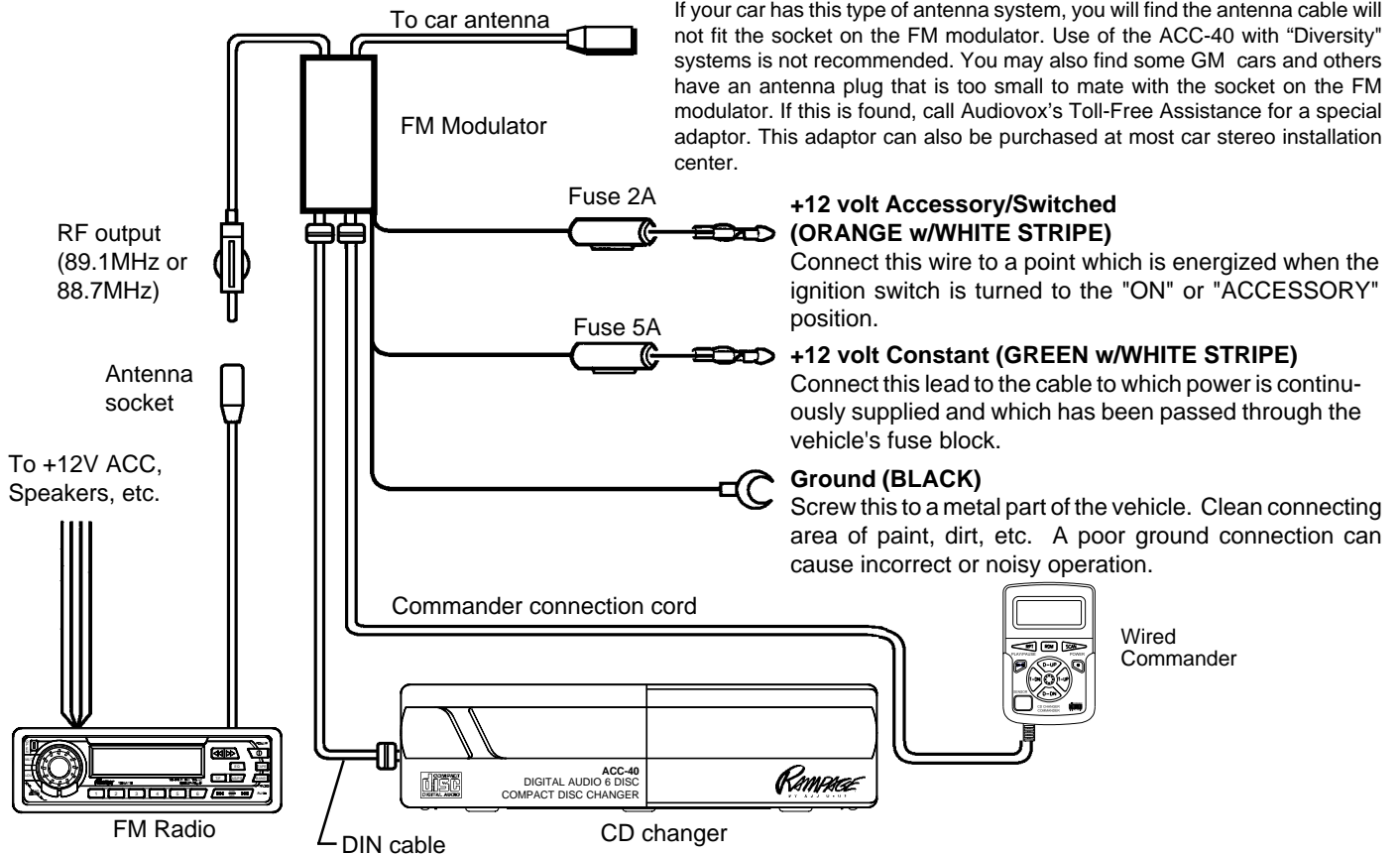

ADJUSTMENT OF FM MODULATOR OUTPUT FREQUENCY

- If there is interference from a local station or a clear signal cannot be obtained on 89.1 MHz., change the position of the frequency select switch on the side of the FM Modulator and tune the radio to 88.7 MHz. when using the CD changer.
- Select the frequency before mounting the FM Modulator.
- Radio sensitivity may be slightly reduced when the FM Modulator is connected.

ADJUSTMENT OF FM MODULATOR AUDIO LEVEL

The audio level from the modulator is factory-set to provide the correct volume balance between radio and CD changer in the majority of installations and usually will not require any adjustment. If, however, a large difference in volume level is noted when switching between CD changer and FM radio operation, the audio level from the CD changer may be adjusted as follows:

1. With the CD changer off, tune to an FM station and adjust the volume control on the radio to a normal listening level.
2. Leaving the volume control at the setting, turn on the CD changer and tune the radio to the modulator output frequency (89.1 or 88.7 MHz.).
3. Select a **LOUD** section of the CD. If the volume level is comparable to that of the FM station in step 1, no adjustment is necessary. If it is noticeably louder or more quiet than that of the radio station, use a # 0 Phillips screwdriver to adjust the "AUDIO LEVEL" control on the modulator so that the CD changer volume is comparable to that of the radio station.

IMPORTANT: If the modulator audio level is adjusted too high, it may result in unacceptable levels of distortion during loud sections of CD's. If set too low, it may result in poor signal/noise levels during CD changer operation.

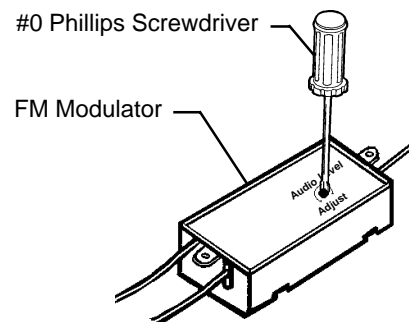
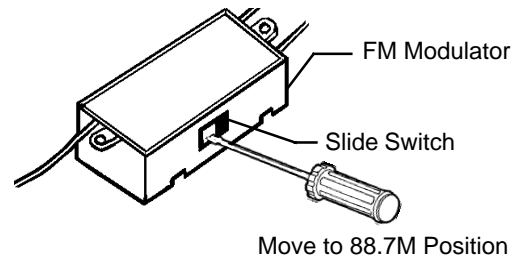

VEHICLE WIRING

IMPORTANT - Some import cars use a special dual antenna "Diversity" system. If your car has this type of antenna system, you will find the antenna cable will not fit the socket on the FM modulator. Use of the ACC-40 with "Diversity" systems is not recommended. You may also find some GM cars and others have an antenna plug that is too small to mate with the socket on the FM modulator. If this is found, call Audiovox's Toll-Free Assistance for a special adaptor. This adaptor can also be purchased at most car stereo installation center.

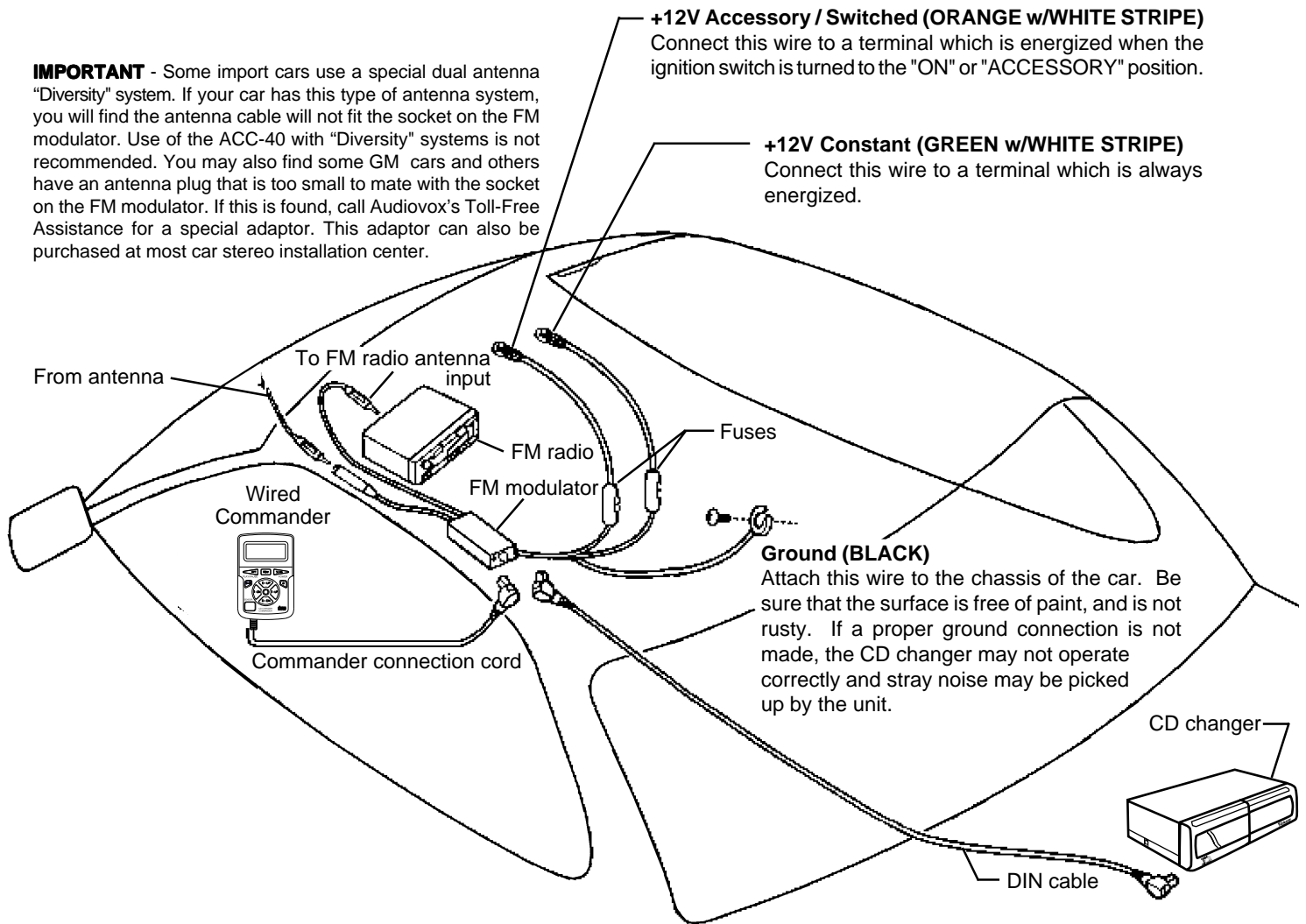

MOUNTING THE FM MODULATOR

Install the FM Modulator to the mounting surface with the small self-tapping screws (M3 x 12).

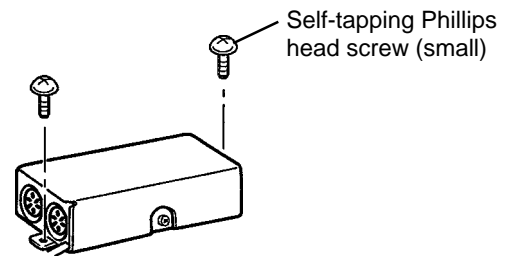

MOUNTING THE WIRED COMMANDER

1. Determine where the commander unit will be located.
2. Be sure that the mounting surface where the commander unit will be located is clean and dry.
3. Remove the protective paper from the back of the Velcro strip.
4. Apply the commander unit to the desired location.

After completing all connections, press the RESET button on the commander unit.

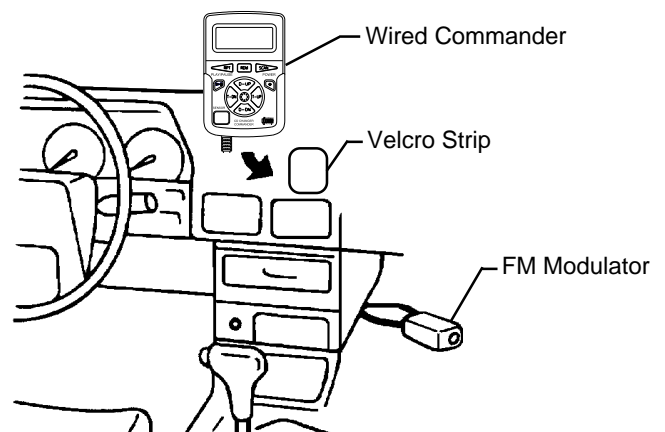

Free Manuals Download Website

<http://myh66.com>

<http://usermanuals.us>

<http://www.somanuals.com>

<http://www.4manuals.cc>

<http://www.manual-lib.com>

<http://www.404manual.com>

<http://www.luxmanual.com>

<http://aubethermostatmanual.com>

Golf course search by state

<http://golfingnear.com>

Email search by domain

<http://emailbydomain.com>

Auto manuals search

<http://auto.somanuals.com>

TV manuals search

<http://tv.somanuals.com>