

RAMPAGE
BY AUDIOVOX

OWNER'S MANUAL

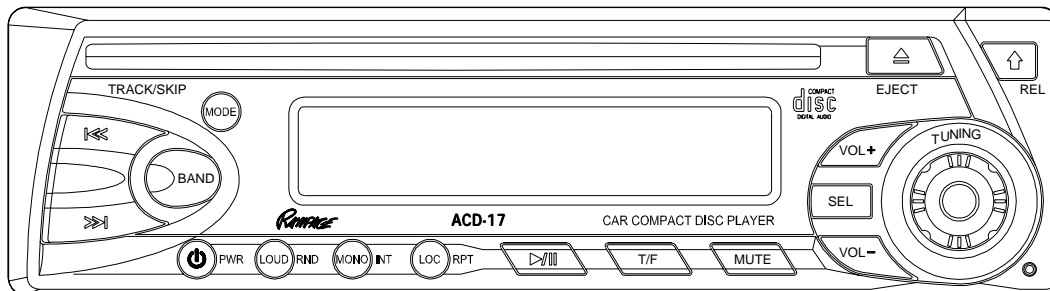

ACD-17

AM/FM/MPX RADIO

WITH DETACHABLE FRONT PANEL,

COMPACT DISC PLAYER

AND QUARTZ CLOCK

THIS PAGE INTENTIONALLY LEFT BLANK

INSTALLATION INSTRUCTIONS

This unit is designed for installation in cars, trucks, and vans with an existing radio opening. In many cases, a special installation kit will be required to mount the radio to the dashboard. These kits are available at electronics supply stores and car stereo specialist shops. Always check the kit application before purchasing to make sure the kit works with your vehicle. If you need a kit but cannot find it available, call our toll-free "HELP" line at **1-800-645-4994**.

UNIVERSAL INSTALLATION PROCEDURE USING MOUNTING SLEEVE

1. Remove the front panel from the unit by pressing the RELease button at the top right corner; then slide the mounting sleeve off of the chassis. If it is locked into position, use the removal tools (supplied) to disengage it.
2. Check the dashboard opening size by sliding the mounting sleeve into it. If the opening is not large enough, carefully cut or file as necessary until the sleeve easily slides into the opening. Do not force the sleeve into the opening or cause it to bend or bow. Check that there will be sufficient space behind the dashboard for the radio chassis.
3. Locate the series of bend tabs along the top, bottom, and sides of the mounting sleeve. With the sleeve fully inserted into the dashboard opening, bend as many of the tabs outward as necessary so that the sleeve is firmly secured to the dashboard.
4. Place the radio in front of the dashboard opening so that the wiring can be brought through the mounting sleeve. Follow the wiring diagram carefully and make certain all connections of the wiring harness are secure and insulated with wire nuts or electrical tape to insure proper operation of the unit. After completing the wiring connections, turn the unit on to confirm operation (ignition switch must be "on"). If unit does not operate, recheck all wiring until problem is corrected.
5. Carefully slide the radio into the mounting sleeve making sure it is right-side-up until it is fully seated and the spring clips lock it into place.
6. Attach one end of the perforated support strap (supplied) to the screw stud on the rear of the chassis using the hex nut provided. Fasten the other end of the perforated strap to a secure part of the dashboard either above or below the radio using the screw provided. Bend the strap to position it as necessary.
CAUTION: The rear of the radio must be supported with the strap to prevent damage to the dashboard from the weight of the radio or improper operation due to vibration.
7. Test radio operation by referring to the Operating Instructions.

INSTALLATION USING KITS

1. If your vehicle requires the use of an installation kit to mount this radio, follow the instructions included with the installation kit to attach the radio to the mounting plate supplied with the kit.
2. Wire and test the radio as described in Step 4 above.
3. Install the radio/mounting plate assembly to the sub-dashboard according to the instructions of the installation kit.
4. Attach the support strap to the radio and dashboard as described in Step 6 above.
5. Replace the dashboard trim panel.

ISO INSTALLATION PROCEDURE

This unit has threaded holes in the chassis side panels which may be used with the original factory mounting brackets of some Toyota, Nissan, Mitsubishi, Isuzu, Hyundai and Honda vehicles to mount the radio to the dashboard. Please consult with your local car stereo specialist shop for assistance on this type of installation.

1. Remove the existing factory radio from its dashboard or center console mounting. Save all hardware and brackets as they will be used to mount the new radio.
2. Carefully unsnap the plastic frame from the front of the new radio chassis. Remove and discard the frame.
3. Remove the factory mounting brackets and hardware from the existing radio and attach them to the new radio.
CAUTION: DO NOT EXCEED M5 X 6 MM MAXIMUM SCREW SIZE.
LONGER SCREWS MAY TOUCH AND DAMAGE COMPONENTS INSIDE THE CHASSIS.
4. Wire the new radio to the vehicle as per step 4 above.
5. Mount the new radio assembly to the dashboard or center console using the reverse procedure of step 1.

TOLL-FREE INSTALLATION ASSISTANCE

The installation and wiring connections for this unit are so simple, we doubt you'll need our help, but, if you do, we're here to help you. Just call our toll-free telephone assistance line at **1-800-645-4994** during the days and hours shown (U.S.A. and Canada only).

DAY	TIME ZONE			
	PACIFIC	MOUNTAIN	CENTRAL	EASTERN
MON. - FRI.	5:30AM - 4PM	6:30AM - 5PM	7:30AM - 6PM	8:30AM - 7PM
SATURDAY	6AM - 2PM	7AM - 3PM	8AM - 4PM	9AM - 5PM

UNIVERSAL INSTALLATION USING MOUNTING SLEEVE

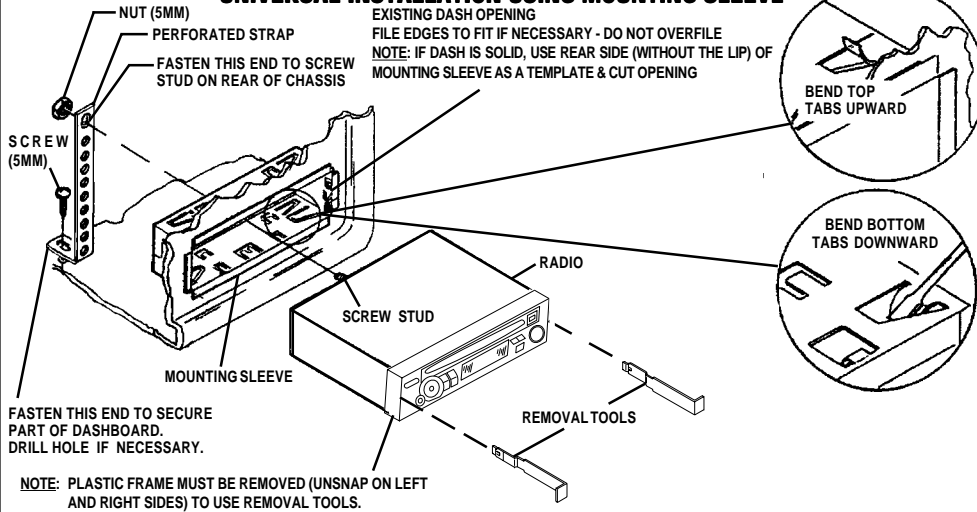

CAUTION:
FOR PROPER OPERATION OF THE CD PLAYER, THE CHASSIS MUST BE MOUNTED WITHIN 20° OF HORIZONTAL. MAKE SURE THE UNIT IS MOUNTED WITHIN THIS LIMITATION.

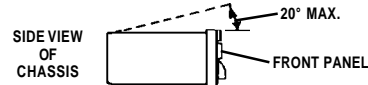

ISO INSTALLATION

REMOVE THE PLASTIC FRAME FROM THE FRONT OF THE CHASSIS BY CAREFULLY UNSNAPPING IT.

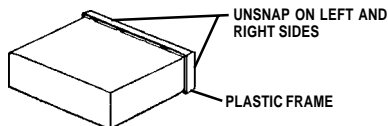

TYPICAL INSTALLATION

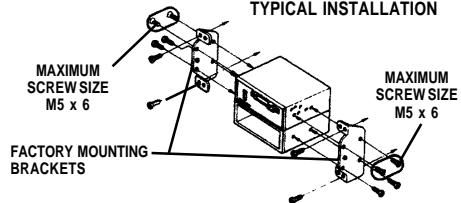

RADIO WIRING

REFER TO PAGE 6 FOR SPEAKER WIRING

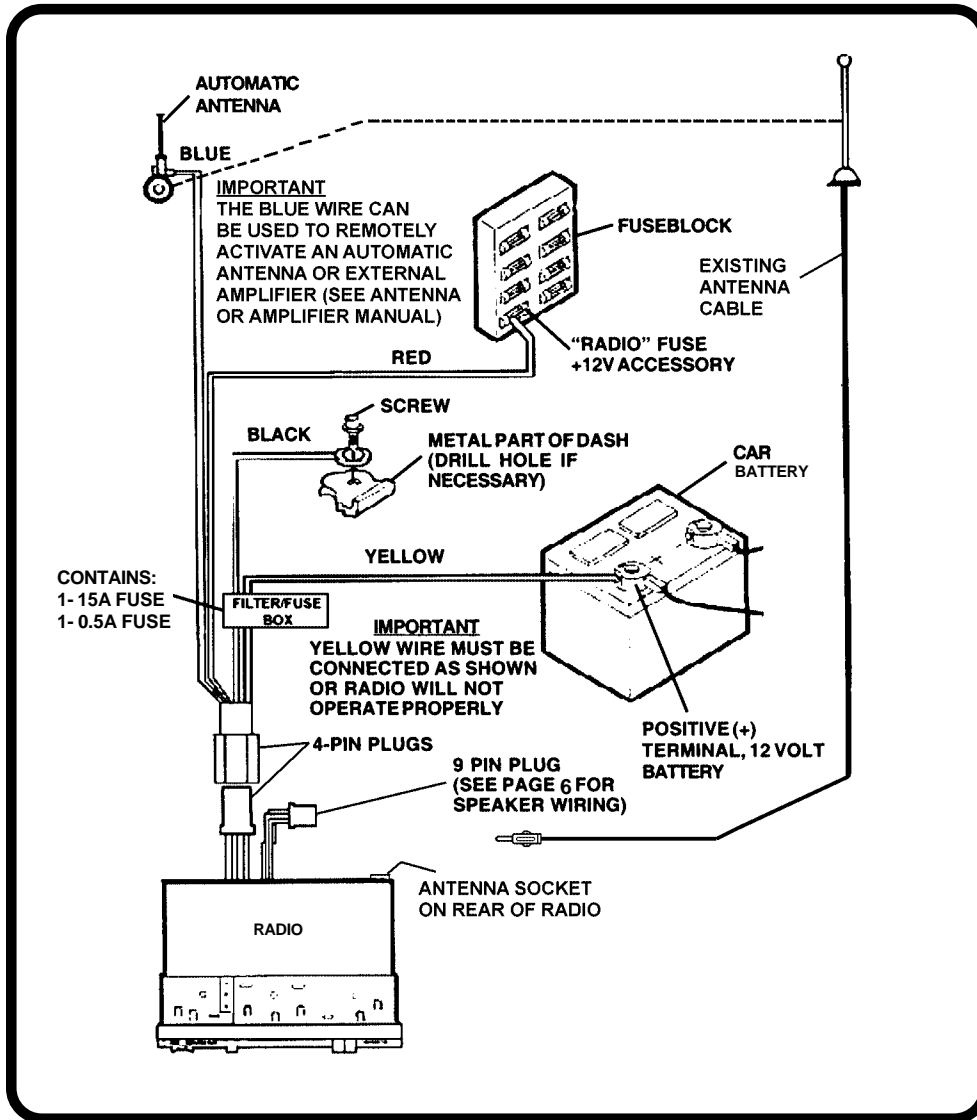

SPEAKER WIRING

REFER TO PAGE 5
FOR RADIO WIRING

WARNING!

- NEVER COMBINE (BRIDGE) OUTPUTS FOR USE WITH 1 SPEAKER.
- NEVER GROUND NEGATIVE SPEAKER LEADS TO CHASSIS GROUND.
- FAILURE TO WIRE EXACTLY AS SHOWN BELOW MAY CAUSE ELECTRICAL DAMAGE TO THE RADIO.

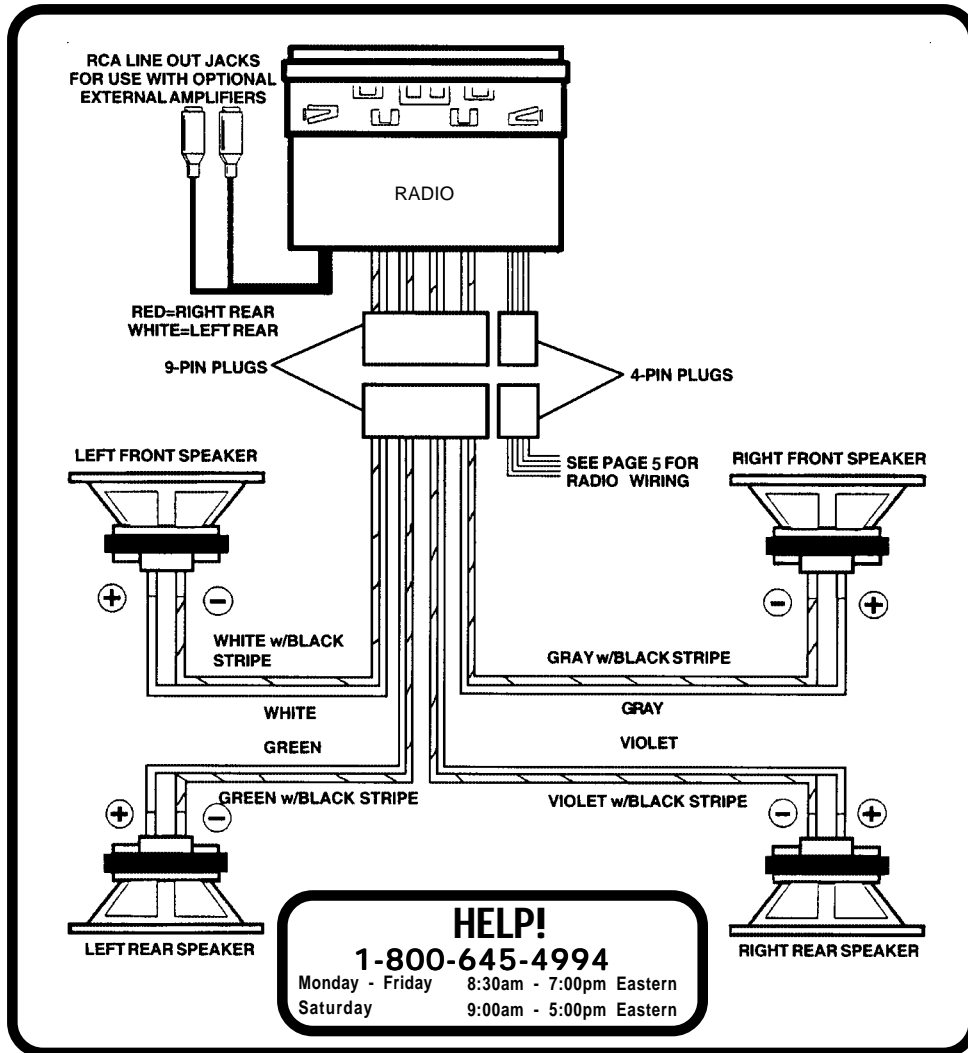

OPERATING INSTRUCTIONS

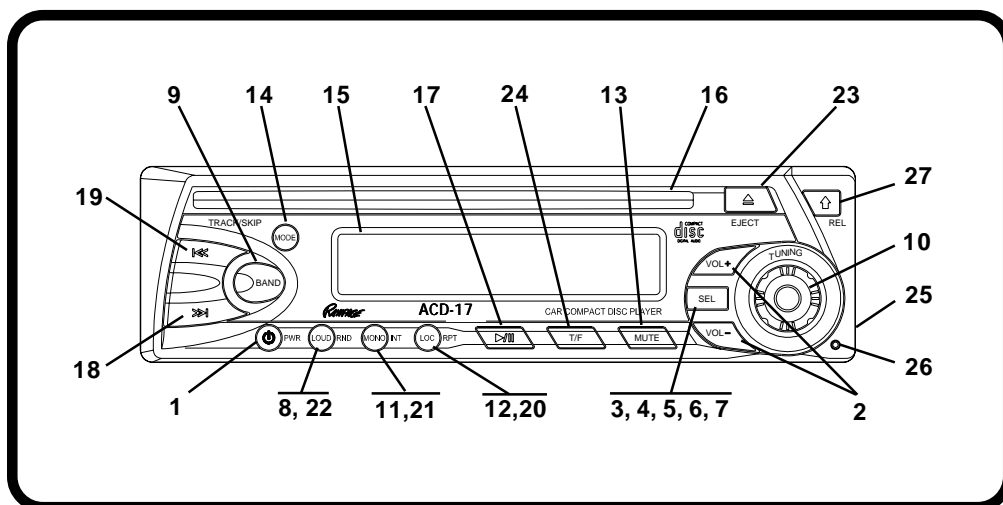

① POWER (PWR) ON-OFF BUTTON

Press this button () to turn the unit on and off when the ignition switch is on. When the unit is off, the time of day is automatically displayed on the Liquid Crystal Display (LCD) panel unless the ignition switch is off. If the radio is off when the ignition switch is turned off, the POWER button must be pressed to turn on the radio after the ignition switch is turned on. If the ignition switch is turned off while the radio is on, the radio will come on automatically when the ignition switch is again turned on.

② VOLUME CONTROL BUTTONS

To increase the volume level, press the VOL + button. The volume will increase and the level will be shown on the display panel from a minimum of **VOL 0** to a maximum of **VOL 63**. To decrease the volume level, press the VOL - button. The display will automatically return to the normal indication 5 seconds after the last volume adjustment or when another function is activated. These buttons are also used in conjunction with the SEL

button to adjust the bass, treble, balance and fader levels as described in ④, ⑤, ⑥, and ⑦.

③ SELECT (SEL) BUTTON

This button is used to select the audio function (volume, bass, treble, balance or fader) to be adjusted using the VOL + and - buttons. Pressing the Select button once will set the unit for volume adjustment (**VOL** will appear on the display panel, followed by the setting number). Pressing the button additional times will select bass adjustment (**BAS** on display panel), treble adjustment (**TRE**), balance (**BAL**), fader (**FAd**), and volume (**VOL**) again. The display will return to the normal indication 5 seconds after the last adjustment or when another function is activated.

④ BASS CONTROL

To adjust the bass level, first select the Bass mode by pressing the SEL button until the **BAS** indication appears on the display panel. Within 5 seconds of choosing the Bass mode, press the VOL + or - buttons to adjust the bass conditions; the unit should be left in the stereo

response as desired. The bass level will be shown on the display panel from a minimum of **BAS -7** to a maximum of **BAS 7** (**BAS 0** represents flat response), with each change accompanied by a beep tone. The display will automatically return to the normal indication 5 seconds after the last adjustment or when another function is activated.

⑤ TREBLE CONTROL

To adjust the treble level, first select the Treble mode by pressing the SEL button until the **TRE** indication appears on the display panel. Within 5 seconds of choosing the Treble mode, press the VOL + or - buttons to adjust the treble response as desired. The treble level will be shown on the display panel from a minimum of **TRE -7** to a maximum of **TRE 7** (**TRE 0** represents flat response), with each change accompanied by a beep tone. The display will automatically return to the normal indication 5 seconds after the last adjustment or when another function is activated.

⑥ LEFT/RIGHT BALANCE CONTROL

To adjust the left-right speaker balance, first select the Balance mode by pressing the SEL button until the **BAL** indication appears on the display panel. Within 5 seconds of choosing the Balance mode, press the VOL + or - buttons to adjust the audio balance between the right channel or left channel speakers, respectively. The balance position will be shown on the display panel from **BAL 10** (full left) to **BAr 10** (full right), with each change accompanied by a beep tone. When the volume level between the left and right speakers is equal, **BAL 0** will be shown on the display panel. The display will automatically return to the normal indication 5 seconds after the last adjustment or when another function is activated.

⑦ FRONT/REAR FADER CONTROL

To adjust the front-rear speaker balance, first select the Fader mode by pressing the

SEL button until the **FAd** indication appears on the display panel. Within 5 seconds of choosing the Fader mode, press the VOL + or - buttons to adjust the front-rear speaker levels as desired. The fader position will be shown on the display panel from **FAF 10** (full front) to **FAr 10** (full rear), with each change accompanied by a beep tone. When the volume level between the front and rear speakers is equal, **FAd 0** will appear on the display panel. The display will automatically return to the normal indication 5 seconds after the last adjustment or when another function is activated.

⑧ LOUDNESS CONTOUR (LOUD)

When listening to music at low volume levels, this feature will boost the bass and treble ranges to compensate for the characteristics of human hearing. Momentarily press the LOUD/RND button to activate this feature as indicated by **LOUD** on the display panel. Pressing the button again will deactivate the function and **LOUD** will disappear from the display.



⑨ AM/FM BAND SELECTOR

During radio play, each time the BAND button is pressed, the radio band changes. The indications **AM** or **FM** will appear on the display panel according to your selection.

⑩ MANUAL TUNING CONTROL

Turn this knob clockwise to tune upward in frequency on the band in use, counter-clockwise to tune downward in frequency. The frequency to which you are tuned will be shown in digital form on the display panel. When tuning in a station, always adjust the control so that the correct broadcast frequency is shown on the display and adjust the control so that you are receiving a clear signal. If the radio is tuned off-frequency, you could experience distorted audio, noise and other reception problems.

11 FM MONO/INTRO (INT) SELECT BUTTON

During FM radio operation, press this button to select mono or stereo reception of the broadcast signal. Under normal reception mode as indicated by the **ST**  icon on the display panel when tuned to an FM stereo signal. If the stereo signal is too noisy for comfortable listening, press the MONO/INT select button to switch to monaural reception (the **ST**  icon will disappear from the display panel). To return to stereo reception mode, press the button again so that the **ST**  indication reappears.

12 LOCAL (LOC)/REPEAT (RPT) BUTTON

During radio operation, received signals are usually in stereo mode as indicated by the **ST**  icon; however, when the signals are weak or intermittent, it may be worthwhile activating the Local (LOC) mode by pressing the LOC/RPT button (**LOC** appears on the display). This mode favors access to local stations whose signals are much stronger, thereby improving radio reception. Press this button again to terminate local receive mode; **LOC** disappears from the display panel.

13 AUDIO MUTE (MUTE)

This button is used to mute the volume from the system. By pressing the button, a **MUTE** indication will appear on the display panel and the volume will be muted. Pressing the MUTE button again, or pressing the Volume Control buttons or Select (SEL) button will return the volume level to the setting in use before the Mute function was activated.

14 MODE BUTTON

This button enables selection of either radio or disc play. When a CD is loaded, pressing this button will revert to radio operation; the disc icon () will still be displayed, indicating a disc is still loaded in the unit. Pressing the button again will return to disc play, but the current track will start from the beginning.

15 LIQUID CRYSTAL DISPLAY PANEL FUNCTIONS

The Liquid Crystal Display (LCD) panel displays the frequency, time, and all activated functions, including five bar graphs which provide a visual representation of the audio signal level.

NOTE: It is a characteristic of LCD panels that, if subjected to cold temperatures for an extended period of time, they may take longer to illuminate than under normal conditions. In addition, the visibility of the numbers on the LCD may slightly decrease. The LCD read-out will return to normal when the temperature increases to a normal range.

16 DISC SLOT

With the label surface facing up, fully insert a compact disc into the slot until the load mechanism engages; **CdP** will appear together with the fixed disc symbol (). The symbol will then become animated and play will begin from the first **TRACK (01)** on the disc, accompanied by the elapsed time of track play.

NOTE: This unit is designed for play of standard 5" (12cm) Compact Discs **ONLY**. Do not attempt to use 3" (8cm) CD-Singles in this unit, either with or without an adapter, as damage to the player and/or disc can occur. Such damage will not be covered by the Warranty on this product.

17 CD PLAY/PAUSE (▶/||) SELECTOR

During disc play, pressing this button will temporarily stop play of the disc (the disc symbol () will flash on the display panel). Press the button again to resume play of the disc from the point at which it was stopped. Playback will continue until all tracks on the disc have been played, after which playback will automatically

stop (unless the repeat mode had been selected).

18 FORWARD TRACK/SKIP SELECTOR (>>>)

During disc play, this button is used to quickly select or skip to the beginning of a particular track in the forward direction. With each press of the button, the next higher **TRACK** number will be selected as shown on the display panel. Press and hold the button to advance rapidly in the forward direction as indicated by the elapsed time display.

19 BACKWARD TRACK/SKIP SELECTOR (<<<)

During disc play, this button is used to quickly select the beginning of a particular track in the backward direction. With each press of the button, the next lower **TRACK** number will be selected as shown on the display panel. Press and hold the button to advance rapidly in the reverse direction as indicated by the elapsed time display.

20 REPEAT PLAY SELECTOR

During disc play, pressing the LOC/RPT button will select the track repeat play mode. **RPT** appears on the display panel. Play of the selected track will continue to repeat until the Track Repeat function is canceled by pressing the button again or by activating the Intro-Scan (INT) or Random (RND) function so that the **RPT** indication disappears.

21 INTRODUCTION (INT) SCAN SELECT



During disc play, press the MONO/INT button to sample or scan the introduction, or first 10 seconds, of each track on the disc. **INT** appears on the display, and each track is played in order. By using this option, you can quickly choose the track(s) on the disc that you prefer. When the desired track is recognized, press the MONO/INT button again to cancel the INT mode, or activate the Repeat or Random function so that **INT** disappears from the display.

22 RANDOM (RND) SELECT

During disc play, press and hold the LOUD/RND button for 2 seconds to play the tracks on the disc in a random or shuffled order (**RND** will appear on the display panel). In Random Play mode, pressing the Forward Track Select button (>>>) will also select tracks in a random order instead of the normal progression.

Pressing the Backward Track Select button (<<<) will also select tracks in random order. The Random Play mode can be cancelled by pressing the button again for 2 seconds (**RND** indication will disappear from the display panel) or by activating the Track Intro-Scan (INT) or Repeat (RPT) function.

23 DISC EJECT (▲) BUTTON

When pressed, disc play is stopped, **EJ** and **Cd** momentarily appear, and the disc is automatically ejected;  will disappear from the display panel and the unit will revert to radio operation. If the disc is not removed from the unit, it will automatically be reloaded within 10 seconds to prevent accidental disc damage. The  icon will remain displayed to indicate a disc is still loaded in the unit. If the disc eject button is pressed during radio operation, the disc is automatically ejected and radio play continues uninterrupted.

NOTE: Always remove the disc from the unit when the disc player is not to be used for an extended period of time to prevent accidental disc damage and to preserve disc life.

24 TIME/FREQUENCY SELECTOR (T/F)

This unit can display either the clock time or radio frequency/CD player functions. Ordinarily, the radio frequency or CD player track indication is displayed, but the display can also show the time when this button is pressed. The time will then be displayed for approximately 5 seconds after which it will return to the radio or CD player function display.

The correct time-of-day can also be set into the unit by pressing the Time/Frequency Selector button. This procedure is outlined later in these operating instructions.

25 THEFT-DETERRENT LED

Located on the chassis behind the front panel, a light-emitting diode (LED) will flash when the panel is physically removed. The flashing light serves as a visual warning to the would-be thief that the unit has been disabled by removal of the front panel.

26 RESET BUTTON

A Reset button is located on the front panel of the unit in the extreme lower right corner. The Reset function is provided to protect the microprocessor circuitry and should only be activated under the

following circumstances as it will erase the time memory:

1. Upon initial installation after all wiring is completed.
2. If there is a malfunction of any of the switches on the unit, pressing the RESET button may clear the system and return to normal operation.

27 PANEL RELEASE (REL) BUTTON

This button (⏏) is used to release the mechanism that holds the front panel to the chassis. To detach the front panel, press the button so that the right side of the panel releases outward. Grasp the panel at the right side and disengage it from the left side of the chassis. To re-attach the panel, engage the left side onto the chassis; then gently press in the right side until it clicks and locks into place.

CD PLAYER ERROR CODES

If a problem should develop while operating the CD player, an error code (ER-1, ER-2, ER-3, etc.) may appear on the display panel. This can indicate a number of problems with the unit, including a mechanical error or an error in the microprocessor control of the player. If an error code should appear, try ejecting and reloading the disc into the player. While the disc is out of the unit, make sure it is clean, undamaged, and loaded correctly (label surface up). You may also try activating the RESET button (26) on the unit, but this will also erase the time memory.

If the suggested measures do not solve the problem, contact an approved warranty station near you for further assistance.

SETTING THE CLOCK

1. Turn the vehicle ignition and radio on.
2. Press and hold the Time/Frequency button (24) for approximately 2 seconds; the time display will begin to flash.
3. Within 5 seconds of selecting the flashing display, press the VOL + button to adjust the hours and the AM/PM indication to the desired setting.
4. Press the VOL - button to adjust the minutes to the desired time.
5. Five seconds after the last hour or minute adjustment is made, the time will be set in the unit and normal operation will resume.

SPECIFICATIONS

Size:	7" W x 2" H x 6-3/4" D 178 mm x 50 mm x 170 mm
Operating Voltage:	12 volts DC, negative ground
Fuse Ratings:	Constant (yellow) lead: 15 AMP. Switched (red) lead: 0.5 AMP.
Output Power:	160 watts maximum (40 watts x 4 channels)
Output Wiring:	Floating-ground type designed for 4 speaker use.
Output Impedance:	Compatible with 4-8 ohm speakers.
Tuning Range:	AM: 530 – 1,710 kHz. FM: 87.5– 107.9 MHz.
Sensitivity:	AM: 32dBu. FM: 3.0 uV
FM Stereo Separation:	> 30 dB
CD Frequency Response:	20 – 20,000 Hz. ± 1 dB
CD Signal/Noise Ratio:	> 60 dB
CD Channel Separation:	> 60 dB
CD Distortion:	0.2%

*Specifications are subject to change without notice.

CARE AND MAINTENANCE

The radio section of your new sound system does not require any maintenance. We recommend that you keep this manual for reference on the many features found in this unit as well as how to set the clock.

The compact disc player section also requires no routine maintenance, but proper understanding of its use and handling will help you obtain maximum enjoyment of its capabilities. The following points should be observed:

- When cleaning the interior of the vehicle, do not get water or cleaning fluids on the unit.
- The CD player is a precision instrument and will not operate properly in extreme heat or cold. In case of such conditions, wait until the interior temperature of the vehicle reaches a normal temperature before using the player.
- If the temperature inside the player gets too hot, a protective circuit will automatically stop play of the disc. In this case, allow the unit to cool off before operating the player again.
- Never insert anything other than a 5" (12 cm) compact disc into the player as the mechanism can be damaged by foreign objects.
- Do not attempt to use 3" (8 cm) CD-Single discs in this unit, either with or without an adaptor, as damage to the player and/or disc may occur. Such damage will not be covered by the Warranty on this product.
- When not using the disc player, always remove the compact disc. Do not leave an ejected disc sitting in the disc slot as this can expose it to sunlight and other causes of damage.
- Do not attempt to open the unit chassis. There are no user serviceable parts or adjustments inside.
- When the vehicle warms up during cold weather or under damp conditions, moisture may condense on the lens of the disc player. Should this occur, the player will not operate properly until the moisture has evaporated.
- The unit is designed with a vibration dampening CD mechanism to minimize interruption of disc play due to normal vibration in a moving vehicle. When driving on very rough roads, however, occasional sound skips may occur. This will not scratch or damage the disc and normal play will resume when the rough conditions cease.

HANDLING COMPACT DISCS

Dirt, dust, scratches, and warpage can cause skips in the playback and deterioration of sound quality. Please follow these guidelines to take care of your compact discs:

- Use only compact discs with the mark  COMPACT DISC DIGITAL AUDIO
- Fingerprints, dust, and dirt should be carefully wiped off the disc's playing surface (shiny side) with a soft cloth. Wipe in a straight motion from the inside to the outside of the disc.
- Never use chemicals such as record sprays, household cleaners or thinner to clean compact discs. Such chemicals can irreparably damage the disc's surface.
- Discs should be kept in their storage cases when not in use.
- Do not expose discs to direct sunlight, high temperatures or high humidity for extended periods.
- Do not stick paper, tape, or labels on the disc surfaces nor write on them with any type of marker.

NOTES ON DISCS:

Attempting to use non-standard shape discs (e.g.; square, star, heart) may damage the unit. Be sure to use round-shape CDs only in this unit.

NOTES ON CD-Rs (Recordable CDs)/CD-RWs (Rewriteable CDs):

1. Be sure to use discs with the following marks only for play in this unit:



2. The unit cannot play a CD-R or CD-RW that is not finalized. (Please refer to the manual of your CD-R/CD-RW software for more information on the finalization process.)
3. Depending on the recording status, conditions of the disc and the equipment used for the recording, some CD-Rs/CD-RWs may not be played on this unit.

RELIABLE PLAYBACK:

To ensure more reliable playback, please note the following recommendations:

1. Use CD-RWs with speed 1x to 4x.
2. Use CD-Rs with speed 1x to 8x, and write with speed 1x to 2x.
3. Do not play a CD-RW which has been written on more than 5 times.

NOTES ON MULTI-SESSION DISCS:

1. If the first track of the first session is audio CD data, then the unit will play only the audio CD data.
2. When the first track of the first session is not audio CD data, but an MP3 file is included on the disc, then only the MP3 files will be played back and other data (including CD data) is skipped.

12 MONTH LIMITED WARRANTY

AUDIOVOX CORPORATION (the Company) warrants to the original retail purchaser of this product that should this product or any part thereof, under normal use and conditions, be proven defective in material or workmanship within 12 months from the date of original purchase, such defect(s) will be repaired or replaced with new or reconditioned product (at the Company's option) without charge for parts and repair labor.

To obtain repair or replacement within the terms of this Warranty, the product is to be delivered with proof of warranty coverage (e.g. dated bill of sale), specification of defect(s), transportation prepaid, to the warranty center at the address shown below.

This Warranty does not extend to the elimination of car static or motor noise, to correction of antenna problems, to costs incurred for installation, removal, or reinstallation of the product, or damage to tapes, compact discs, speakers, accessories, or vehicle electrical systems.

This Warranty does not apply to any product or part thereof which, in the opinion of the Company, has suffered or been damaged through alteration, improper installation, mishandling, misuse, neglect, accident, or by removal or defacement of the factory serial number/bar code label(s). THE EXTENT OF THE COMPANY'S LIABILITY UNDER THIS WARRANTY IS LIMITED TO THE REPAIR OR REPLACEMENT PROVIDED ABOVE AND, IN NO EVENT, SHALL THE COMPANY'S LIABILITY EXCEED THE PURCHASE PRICE PAID BY PURCHASER FOR THE PRODUCT.

This Warranty is in lieu of all other express warranties or liabilities. ANY IMPLIED WARRANTIES, INCLUDING ANY IMPLIED WARRANTY OF MERCHANTABILITY, SHALL BE LIMITED TO THE DURATION OF THIS WRITTEN WARRANTY. ANY ACTION FOR BREACH OF ANY WARRANTY HEREUNDER INCLUDING ANY IMPLIED WARRANTY OF MERCHANTABILITY MUST BE BROUGHT WITHIN A PERIOD OF 30 MONTHS FROM DATE OF ORIGINAL PURCHASE. IN NO CASE SHALL THE COMPANY BE LIABLE FOR ANY CONSEQUENTIAL OR INCIDENTAL DAMAGES FOR BREACH OF THIS OR ANY OTHER WARRANTY, EXPRESS OR IMPLIED, WHATSOEVER. No person or representative is authorized to assume for the Company any liability other than expressed herein in connection with the sale of this product.

Some states do not allow limitations on how long an implied warranty lasts or the exclusion or limitation of incidental or consequential damage so the above limitations or exclusions may not apply to you. This Warranty gives you specific legal rights and you may also have other rights which vary from state to state.

U.S.A.: AUDIOVOX CORPORATION, 150 MARCUS BLVD., HAUPPAUGE, NEW YORK 11788 • 1-800-645-4994

CANADA: CALL 1-800-645-4994 FOR LOCATION OF WARRANTY STATION SERVING YOUR AREA

Form No. 128-4270E



© 2003 Audiovox Electronics Corp., Hauppauge, NY 11788

Printed in China

128-6496A

Free Manuals Download Website

<http://myh66.com>

<http://usermanuals.us>

<http://www.somanuals.com>

<http://www.4manuals.cc>

<http://www.manual-lib.com>

<http://www.404manual.com>

<http://www.luxmanual.com>

<http://aubethermostatmanual.com>

Golf course search by state

<http://golfingnear.com>

Email search by domain

<http://emailbydomain.com>

Auto manuals search

<http://auto.somanuals.com>

TV manuals search

<http://tv.somanuals.com>