

RAMPAGE
BY AUDIOVOX™

OWNER'S MANUAL

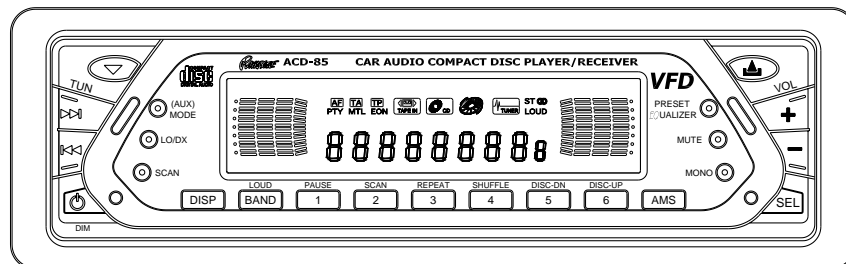

ACD-85

**AM/FM/MPX RADIO WITH SLIDE-DOWN
DETACHABLE FRONT PANEL,
COMPACT DISC PLAYER,
CD CHANGER CONTROLS,
WIRELESS REMOTE CONTROL
AND QUARTZ CLOCK**

INSTALLATION INSTRUCTIONS

This unit is designed for installation in cars, trucks, and vans with an existing radio opening. In many cases, a special installation kit will be required to mount the radio to the dashboard. These kits are available at electronics supply stores and car stereo specialist shops. Always check the kit application before purchasing to make sure the kit works with your vehicle. If you need a kit but cannot find it available, call our toll-free "HELP" line (1-800-645-4994).

UNIVERSAL INSTALLATION PROCEDURE USING MOUNTING SLEEVE

1. Open, fold down and remove the detachable front panel, if it is attached to the chassis, by pressing the release button on the upper right corner and disengaging the left side from the panel mounting plate. Slide the mounting sleeve off of the chassis. If it is locked into position, use the removal tools (supplied) to disengage it.
2. Check the dashboard opening size by sliding the mounting sleeve into it. If the opening is not large enough, carefully cut or file as necessary until the sleeve easily slides into the opening. Do not force the sleeve into the opening or cause it to bend or bow. Check that there will be sufficient space behind the dashboard for the radio chassis.
3. Locate the series of bend tabs along the top, bottom, and sides of the mounting sleeve. With the sleeve fully inserted into the dashboard opening, bend as many of the tabs outward as necessary so that the sleeve is firmly secured to the dashboard.
4. Place the radio in front of the dashboard opening so that the wiring can be brought through the mounting sleeve. Follow the wiring diagram carefully and make certain all connections of the wiring harness are secure and insulated with wire nuts or electrical tape to insure proper operation of the unit. After completing the wiring connections, attach the front panel and turn the unit on to confirm operation (ignition switch must be "on"). If unit does not operate, re-check all wiring until problem is corrected. Once proper operation is achieved, turn off the ignition switch and proceed with final mounting of the chassis.
5. Carefully slide the radio into the mounting sleeve making sure it is right-side-up until it is fully seated and the spring clips lock it into place.
6. Attach one end of the perforated support strap (supplied) to the screw stud on the rear of the chassis using the hex nut provided. Fasten the other end of the perforated strap to a secure part of the dashboard either above or below the radio using the screw and hex nut provided. Bend the strap to position it as necessary.
CAUTION: The rear of the radio must be supported with the strap to prevent damage to the dashboard from the weight of the radio or improper operation due to vibration.
7. Re-attach the front panel to the chassis. Establish a location for the remote input jack (usually the underside of the dashboard) if it is a feature of the radio. Anchor it in place using two self-tapping screws (M5x6). Do not over-tighten screws. Test radio operation by referring to the Operating Instructions for the unit.

INSTALLATION USING KITS

1. If your vehicle requires the use of an installation kit to mount this radio, follow the instructions included with the installation kit to attach the radio to the mounting plate supplied with the kit.
2. Wire and test the radio as described in Step 4 above.
3. Install the radio/mounting plate assembly to the sub-dashboard according to the instructions of the installation kit.
4. Attach the support strap to the radio and dashboard as described in Step 6 above.
5. Replace the dashboard trim panel.

ISO INSTALLATION PROCEDURE

This unit has threaded holes in the chassis side panels which may be used with the original factory mounting brackets of some Toyota, Nissan, Mitsubishi, Isuzu, Hyundai and Honda vehicles to mount the radio to the dashboard. Please consult with your local car stereo specialist shop for assistance on this type of installation.

1. Remove the existing factory radio from its dashboard or center console mounting. Save all hardware and brackets as they will be used to mount the new radio.
2. Carefully un-snap the plastic frame from the front of the new radio chassis. Remove and discard the frame.
3. Remove the factory mounting brackets and hardware from the existing radio and attach them to the new radio.

CAUTION: DO NOT EXCEED M5 X 6 MM MAXIMUM SCREW SIZE.

LONGER SCREWS MAY TOUCH AND DAMAGE COMPONENTS INSIDE THE CHASSIS.

4. Wire the new radio to the vehicle as per step 4 above.
5. Mount the new radio assembly to the dashboard or center console using the reverse procedure of step 1.

TOLL-FREE INSTALLATION ASSISTANCE

The installation and wiring connections for this unit are so simple, we doubt you'll need our help, but, if you do, we're here to help you. Just call our toll-free telephone assistance line at **1-800-645-4994** during the days and hours shown (U.S.A. and Canada only).

| DAY | TIME ZONE | | | |
|-------------|--------------|--------------|--------------|--------------|
| | PACIFIC | MOUNTAIN | CENTRAL | EASTERN |
| MON. - FRI. | 5:30AM - 4PM | 6:30AM - 5PM | 7:30AM - 6PM | 8:30AM - 7PM |
| SATURDAY | 6AM - 2PM | 7AM - 3PM | 8AM - 4PM | 9AM - 5PM |

UNIVERSAL INSTALLATION USING MOUNTING SLEEVE

EXISTING DASH OPENING
FILE EDGES TO FIT IF NECESSARY - DO NOT OVERFILE
NOTE: IF DASH IS SOLID, USE REAR SIDE (WITHOUT THE LIP) OF MOUNTING SLEEVE AS A TEMPLATE & CUT OPENING

BEND TOP TABS UPWARD

BEND BOTTOM TABS DOWNWARD

CAUTION:
FOR PROPER OPERATION OF THE CD PLAYER, THE CHASSIS MUST BE MOUNTED WITHIN 20° OF HORIZONTAL. MAKE SURE THE UNIT IS MOUNTED WITHIN THIS LIMITATION.

SIDE VIEW OF CHASSIS
20° MAX.
FRONT PANEL

REMOVAL TOOLS

DETACHABLE FRONT PANEL

ISO INSTALLATION

REMOVE THE PLASTIC FRAME FROM THE FRONT OF THE CHASSIS BY CAREFULLY UN-SNAPPING IT.

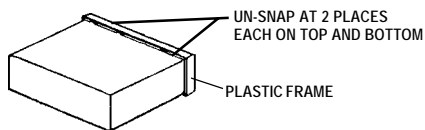

TYPICAL INSTALLATION

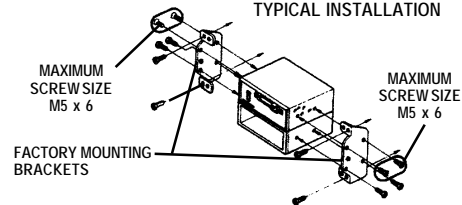

RADIO WIRING

REFER TO PAGE 5 FOR SPEAKER WIRING

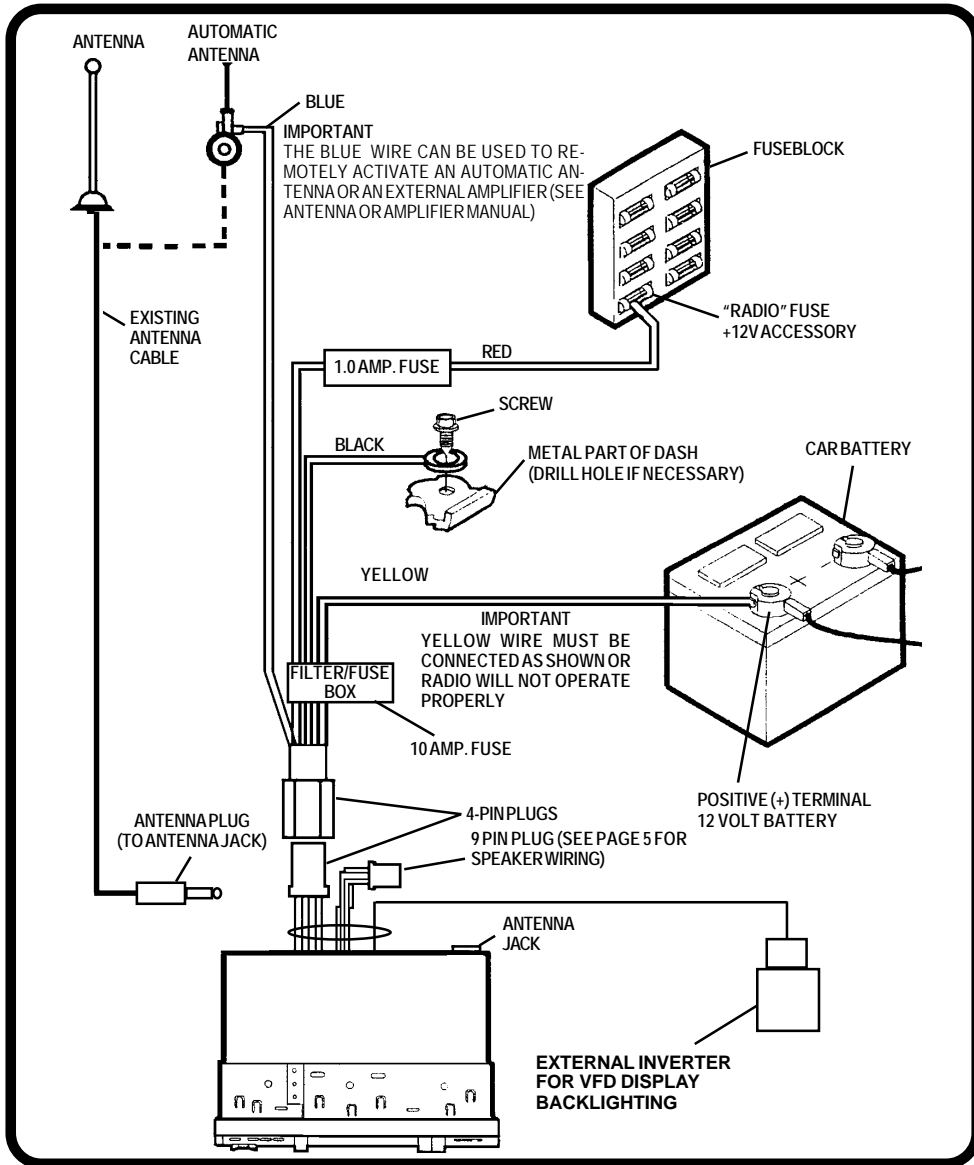

SPEAKER WIRING

REFER TO PAGE 4 FOR RADIO WIRING

WARNING!

- THE AMPLIFIERS IN THIS RADIO ARE **ONLY** DESIGNED FOR USE WITH 4 SPEAKERS.
- **NEVER** COMBINE (BRIDGE) OUTPUTS FOR USE WITH 2 SPEAKERS.
- **NEVER** GROUND NEGATIVE SPEAKER LEADS TO CHASSIS GROUND.
- FAILURE TO WIRE EXACTLY AS SHOWN BELOW MAY CAUSE ELECTRICAL DAMAGE TO THE RADIO.

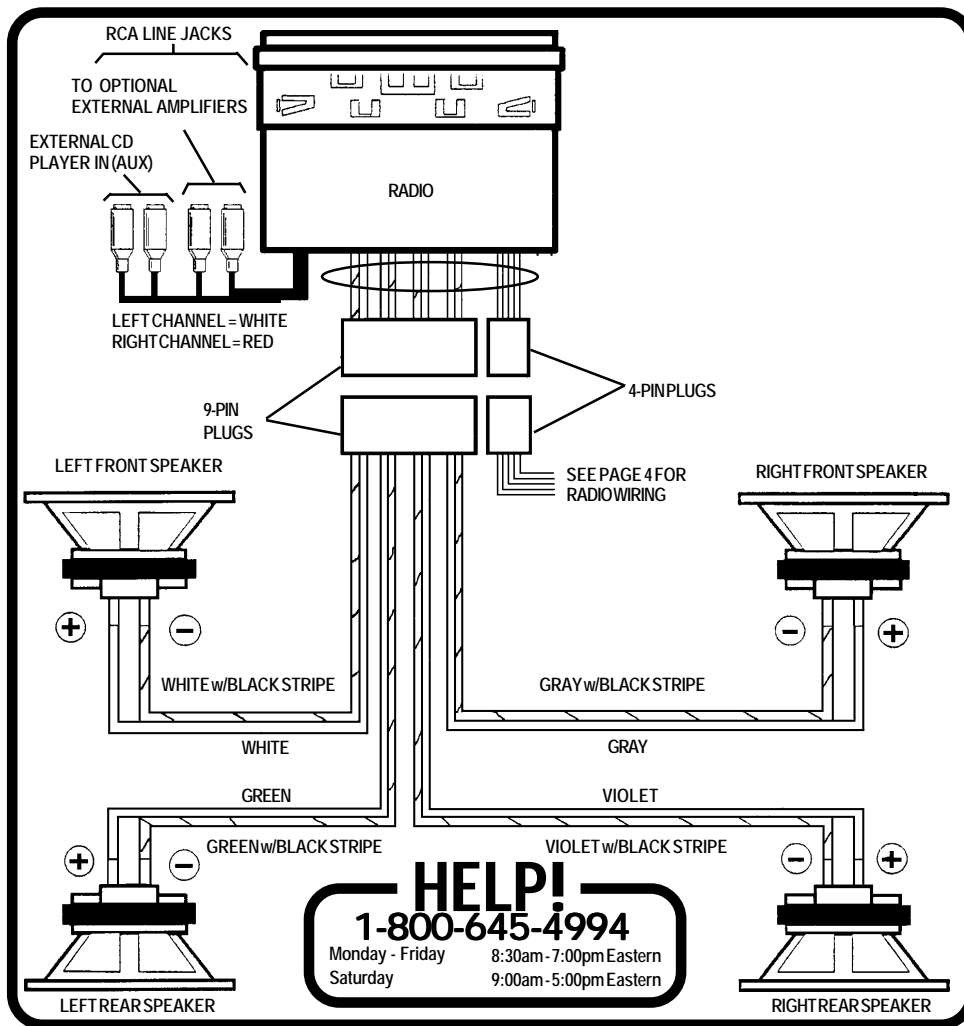

OPERATING INSTRUCTIONS

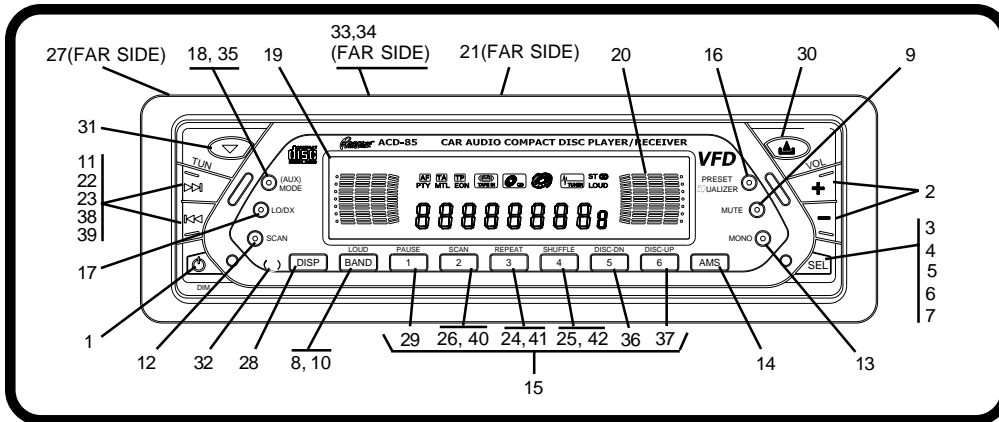

① POWER ON/OFF AND DIM BUTTON

Momentarily press this button to turn the unit on; the  icon appears on the display. Press the button for at least 2 seconds to turn the unit off. If the ignition switch is "on", the unit will also turn on automatically when a compact disc is inserted, or if any other front panel control button is pressed. While the unit is on, each time the button is momentarily pressed and released, the VFD display panel backlighting intensity will change from low-to-medium-to-high, and then back to low, thereby providing three different intensity settings.

② AUDIO CONTROL (VOL +/-) BUTTONS

To increase the volume level, press the + button. The volume will increase and the level will be shown on the display panel from a minimum of **VOL 00** to a maximum of **VOL 100**. To decrease the volume level, press the - button. The display will automatically return to the normal indication 5 seconds after the last volume adjustment or when another function is activated. These control buttons are also used in conjunction with the Select (SEL) button ③ to adjust the bass, treble, balance and fader levels as described in ④, ⑤, ⑥ and ⑦.

③ SELECT (SEL) CONTROL BUTTON

This button is used to select the audio function (volume, bass, treble, balance, or fade) whose

setting is adjusted using the AUDIO CONTROL buttons ②. Pressing the SEL button once will set the unit for volume adjustment (**VOL** will appear on the display panel) and an audible beep will occur. Pressing the button additional times will select bass adjustment (**BAS** will appear on the display panel), treble adjustment (**TRE** on the display), balance (**BAL**), or fader (**FAD**). The display will automatically return to the normal indication 5 seconds after the last adjustment or when another function is activated.

NOTE: Regardless of the Preset Equalizer setting, whenever Base, Treble, Balance or Fader settings are adjusted, the Equalizer setting will always return to **FLAT** mode.

④ BASS CONTROL

To adjust the bass level (Equalizer function inactive), first select the Bass level (Equalizer function inactive), first select the Bass mode by pressing the SEL button so the **BAS** indication appears on the display panel. Within 5 seconds of choosing the Bass mode, press the VOL - button to decrease the bass response, or the VOL + button to increase it as desired. The level will be shown on the display panel from a minimum **BAS -10** to a maximum of **BAS +10** (**BAS 00** indicates flat response). The display will automatically return to the normal indication 5 seconds after the last adjustment or when another function is activated.

5 TREBLE CONTROL

To adjust the treble level (Equalizer function inactive), first select the Treble mode by pressing the SEL button so the **TRE** indication appears on the display panel. Within 5 seconds of choosing the Treble mode, press the VOL - button to decrease the treble response or the VOL + button to increase it as desired. The level will be shown on the display panel from a minimum **TRE -10** to a maximum of **TRE +10** (**TRE 00** indicates flat response). The display will automatically return to the normal indication 5 seconds after the last adjustment or when another function is activated.

6 LEFT/RIGHT BALANCE CONTROL

To adjust the left-right speaker balance, first select the Balance mode by pressing the SEL button so the **BAL** indication appears on the display panel. Within 5 seconds of choosing the Balance mode, press the VOL - button to adjust the stereo balance to the left channel speakers or the VOL + button to adjust it to the right channel speakers. The balance position will be shown on the display panel from **BAL 10L** (full left) to **BAL 10R** (full right). When the volume level between the left and right speakers is equal, **BAL L--R** will be shown on the display panel. The display will automatically return to the normal indication 5 seconds after the last adjustment or when another function is activated.

7 FRONT/REAR FADER CONTROL

To adjust the front-rear speaker balance, first select the Fader mode by pressing the SEL button so the **FAD** indication appears on the display panel. Within 5 seconds of choosing the Fader mode, press the VOL - button to adjust the front-rear speaker balance to the rear speakers or the VOL + button to adjust it to the front speakers. The fader position will be shown on the display panel from **FAD 10R** (full rear) to **FAD 10F** (full front). When the level between the front and rear speakers is equal, **FAD F--R** will be shown on the display panel. The display will automatically return to the normal indication 5 seconds after the last adjustment or when another function is activated.

8 LOUDNESS CONTOUR (LOUD)

When listening to music at low volume levels, this feature will boost the bass and treble ranges to compensate for the characteristics of human

hearing. Press and hold the BAND/LOUD button for 2 seconds to activate this feature and the indication **LOUD ON** will appear for 5 seconds on the display panel. Pressing the button again for 2 seconds will deactivate the feature and the **LOUD OFF** indication will appear for 5 seconds and then disappear. Momentarily pressing this button will activate the AM/FM band function bl.

9 AUDIO MUTE (MUTE)

This button is used to mute the volume from the system. By pressing the button, the current display (radio frequency, or CD player/changer disc/track indication) will be replaced by a flashing **MUTE** indication, and the volume will be muted. Although volume is muted in CD play mode, the disc/track indication will continue to increment, indicating continuation of disc play. Pressing the MUTE button again, or activating any other button, except MODE (AUX), will return the volume level to the setting in use before the Mute function was activated. If a disc is being played, and the CD PAUSE button is pressed, the Mute function will be deactivated when disc play is unpaused.

10 AM/FM BAND SELECTOR (BAND)

Each time the BAND/LOUD button is pressed momentarily, the radio band is changed. The indication **FM1**, **FM2**, **FM3** or **AM** will appear on the display panel according to your selection. When this button is pressed and held for 2 seconds or more, the LOUD function ⑧ is activated.



11 UP/DOWN TUN (▶▶|/|◀◀) BUTTONS

To select a radio station, momentarily press the Up Tuning (▶▶|) button to advance the unit higher, or the Down Tuning (|◀◀) button to tune lower within the selected band. In the LOCAL mode, each momentary press will advance or lower the tuning frequency to the next active local station; in the DX mode, each momentary press will advance or lower tuning to the next active distant station. When the TUN button is pressed and held, **MANUAL** appears momentarily on the display accompanied by a beep tone, and the radio is rapidly tuned upward or downward without pause as long as the button is pressed. When the button is released, tuning stops at the displayed station. If further tuning is not performed within 5 seconds, **AUTO** momentarily appears on the display, and tuning reverts to the previous tuning mode.

12 SCAN BUTTON

This feature allows you to automatically sample each available station in the current band. When the button is pressed, the frequency will advance upward, stopping at each available station (depending on LO/DX mode) for 5 seconds. When a desired station is reached, press the SCAN button again to cancel the function and play of the selected station will continue.

13 FM MONO/STEREO OPERATION

During normal FM reception conditions, the unit is in the stereo mode as indicated by the **ST**  indication on the display panel when tuned to an FM stereo signal. If the FM stereo signal is too weak or noisy, the indication will appear intermittently, or completely disappear from the display panel. Whenever a weak FM signal occurs, press the MONO button to switch to monaural reception to reduce noise. To return to stereo reception mode, press the MONO button again; the **ST**  indication will reappear on the display panel.

14 AUTOMATIC MEMORY STORE (AMS)

During radio operation, momentarily press this button to activate the Automatic Memory Store tuning feature for the AM and FM bands. During FM operation, this feature will automatically scan the current band and enter up to 6 strong stations into the 6 pre-set memories, pausing at each station for approximately 5 seconds so each can be heard. Scan will then move on to the next FM band and perform the same function. The FM station being pre-set will flash as each position is addressed. To stop station scan, press the AMS button again. If you have already set the pre-set memories to your favorite stations, activating the AMS feature will erase those stations and enter the new strong stations. This feature is most useful when traveling in a new area where you are not familiar with the local stations.

15 STATION PRE-SET MEMORIES

To set any of the 6 pre-set memories in each band, use the following procedure:

1. Turn the radio on and select the desired band.
2. Select the first station to be pre-set using the TUN Up/Down or SCAN buttons.
3. Press the pre-set button (1-6) to be set and continue to hold it in. After approximately 2 seconds, the pre-set number will appear on the display panel accompanied by a beep, indicating

that the station is now set into that pre-set memory position. The station can now be recalled at any time by pressing that button.

4. Repeat the above procedure for the remaining pre-sets on that band and for the other 3 bands on the unit.



16 PRESET EQUALIZER BUTTON

The PRESET EQUALIZER button applies preset sound effects to the unit's audio output signal. The button, when pressed, will activate one of four operating modes (**FLAT**, **CLASSICS**, **ROCK**, or **POP**). When the equalizer function is not active (**DSP OFF**), the unit returns to the user-set bass and treble levels. Digital Signal Processing (**DSP**) refers to the selection of the automatic preset equalizer function instead of user-selected bass and treble settings.

17 LOCAL/DISTANT (LO/DX) BUTTON

During station tuning, the LO/DX button allows you to priority access strong local stations only, or to access a wider range of stations using the distant (DX) mode. When this button is pressed, **LOCAL** appears on the display for about 8 seconds, indicating that the tuning priority is set for local stations. Therefore, as the radio is tuned up or down, tuning will pause only at strong local stations. This feature is useful when traveling in unfamiliar areas, trying to find a local station. When the button is pressed again, **DX** appears on the display for about 8 seconds, and the tuning priority is set for a wider range of stations.

18 MODE (AUX) BUTTON

The MODE (AUX) button provides selection of radio, CD player or optional CD changer operation, or external CD input operation (AUX). During radio operation, the first momentary press of this button initiates CD player operation when a disc is loaded ( illuminated on the display) in the player; the disc symbol () becomes animated and disc play begins. When pressed a second time, optional CD changer operation is initiated; **CDC** appears on the display, together with the disc and track numbers, and the disc symbol again becomes animated. A third press of this button returns to radio operation. When an external CD player is connected to the auxiliary CD IN jacks, the MODE button provides selection of this AUX input when pressed and held for 2 seconds; no other source selection can be heard. Press the button again for 2 seconds and the AUX input is inhibited.



19 VACUUM FLUORESCENT DISPLAY (VFD)

The Vacuum Fluorescent Display (VFD) panel displays the frequency, time, and activated functions using one of three illumination levels as selected by the Power/DIM button 1.

20 POWER LEVEL METER DISPLAY



This display consists of left and right three-bar graphs which provide a visual representation of the volume level and the left and right channel audio signal levels. The volume level is represented by the two outer bar graphs. As the volume is increased, the number of illuminated segments will increase. The left and right channels are represented by the two inner bar graphs whose illuminated segments increase and decrease as a function of the signal strength applied to the left and right channels. As the signal increases, the number of illuminated segments will increase and vice-versa.

21 DISC SLOT

The disc slot is located behind the front panel. With the disc label surface facing up, gently insert the disc into the slot until the soft-loading mechanism engages; **S--CDP** appears momentarily, the  symbol illuminates, indicating a disc is loaded in the unit, and the  symbol becomes animated and disc play begins. The track number and elapsed time will appear on the display panel.

CAUTION: This unit is designed for play of standard 5" (12cm) Compact Discs ONLY. Do not attempt to use 3" (8cm) CD-Singles in this unit, either with or without an adapter, as damage to the player and/or disc can occur. Such damage will not be covered by the Warranty on this product.

22 TRACK SELECT

During disc play, these buttons are used to quickly select the beginning of a particular track. With each momentary tap of the Forward Track Select button () , the next higher track number will be selected as shown on the display panel. Similarly, with each momentary tap of the Backward Track Select button () , the current selected track will return to the beginning of play.

23 CUE/REVIEW FUNCTIONS



High-speed audible search to any section of the disc can be made by the Cue and Review functions. Press and hold the Cue button () to ad-

vance rapidly in the forward direction or the Review button () to advance rapidly in the backward direction. During either function, the elapsed time within each track will automatically be shown on the display panel.

24 REPEAT PLAY SELECTOR

During disc play, press this button to repeat the play of the selected track (**S--RPT** and the track number will appear on the display panel). Play of the track will continue to repeat until the button is pressed again and the **RPT** indication disappears from the display panel. Repeat Play mode will also be cancelled by activating the Shuffle Play **23** or Track Scan **24** functions.

25 SHUFFLE (RANDOM) PLAY SELECTOR

During disc play, press this button to play the tracks on the disc in a random or shuffled order (**S--SHF** and the track number will appear on the display panel). In Shuffle Play mode, pressing the Forward Track Select () will also select tracks in a random order instead of the normal progression. The first press of the Backward Track Select () will go back to the beginning of the track in play. The Shuffle Play mode can be canceled by pressing the button again (**S--RDM** indication will disappear from the display panel) or by activating the Repeat Play **22** or Track Scan **24** functions.

26 TRACK SCAN (INTRODUCTION) SELECTOR

During disc play, press this button to play the first 10 seconds of each track on the disc (**S--SCN** and the track number will appear on the display panel). When a desired track is reached, press the SCAN button again to cancel the function and play of the selected track will continue. The Track Introduction Scan mode will also be cancelled by activating the Repeat Play **22** or Shuffle Play **23** functions.

27 DISC EJECT (▲)

Disc play is stopped, the disc is ejected and the unit will change to radio operation by pressing this button behind the front panel. If the disc is not removed from the disc slot within 15 seconds of being ejected, it will automatically be re-loaded into the unit to prevent it from being accidentally damaged. Play of the disc can be resumed by pressing the MODE (AUX) button to choose the CD player function; **S--CDP** appears on the display.

28 TIME/FREQUENCY SELECTOR (DISP)



This unit can display either the clock time or radio frequency/CD player functions. Ordinarily, the radio frequency or CD player track indication is displayed, but the display can also show the time when this button is pressed. The time will then be displayed for approximately 5 seconds, after which it will return to the radio or CD player function display.

The correct time-of-day can also be set into the unit by pressing the DISP button. This procedure is outlined later in these operating instructions.

29 CD PLAY/PAUSE (PAUSE) BUTTON

This button is used to pause disc play when desired. During CD player or optional changer operation, this button may be used to pause disc play without ejecting the disc in the player (the  indication will remain on the display panel to show that a disc is still loaded in the unit). Press the button again to resume disc play from the point at which it was stopped.

30 FRONT PANEL FOLD-DOWN BUTTON

This button is used to release the mechanism that holds the front panel to the chassis. To detach the front panel, press the  button so that the panel folds down to the lowered position. This position permits access to the CD slot and the CD Eject ( button).

31 FRONT PANEL REMOVAL (▼) BUTTON

This button is used to release the mechanism that holds the front panel to the panel mounting plate. To detach the front panel, press the button so that the left side of the panel is released. Grasp the released side and pull it off of the chassis. To re-attach the panel, position the right side of the panel in place first and then press the left side of the panel until the mechanism locks it into place.

32 REMOTE SENSOR

The sensor to detect the infrared signal from the wireless remote control is located behind the VFD display lens. For optimum operation of the remote control, always aim the control at the VFD display.

33 THEFT-DETERRENT LED

The theft-deterrent Light Emitting Diode (LED) is located behind the front panel on the left side of the chassis and is accessible when the front panel is removed. The flashing light serves as a visual warning to the would-be thief that the unit has been disabled by removal of the front panel.

34 RESET BUTTON

A RESET button is located on the front of the chassis above the theft-deterrent LED (front panel must be in the fold-down position to access the button). The Reset circuitry is provided to protect the microprocessor circuitry and should only be activated under the following circumstances, as it will erase the time and tuner pre-set memories:

1. Upon initial installation after all wiring is completed.
2. If there is a malfunction of any of the switches on the unit, pressing the RESET button may clear the system and return to normal operation.

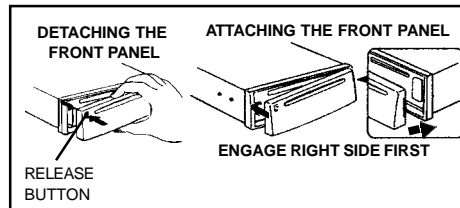

NOTES ON USE OF FRONT PANEL

1. Make sure the front panel is right-side-up when attaching it to the chassis as it cannot be attached when up-side down.
2. Do not press very hard on the front panel when attaching it to the chassis. No more than light to moderate pressure should be needed.
3. When attaching the front panel, make sure the right side is correctly engaged before pressing the left side to lock it into position.
4. When taking the front panel with you, please use the supplied carrying case to protect the panel from dirt and damage. Make sure there is no dust or dirt on the electrical terminals on the back of the panel as this could cause intermittent operation or other malfunctions.

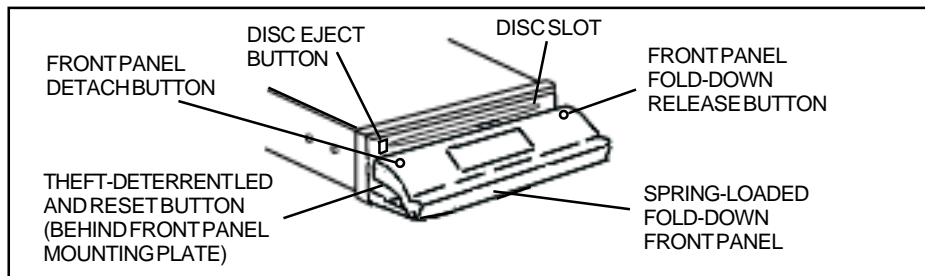



SETTING THE CLOCK

1. Turn the vehicle ignition and radio "on".
2. Momentarily press the DISP button ; the time display will appear. Press and hold the DISP button for approximately 5 seconds (until the time display begins to flash).
3. While the display is flashing, press the Up TUNing button () to adjust the hours and the Down TUNing button () to adjust the minutes to the correct time.

NOTE: The clock display is based on a 24-hour day; **AM** = 1 AM to 12 Noon, while **PM** = 1 PM (13) to 12 Midnight (24).

4. Five seconds after the last hour or minute adjustment is made, the time will be set in the unit; the adjusted time display will stop flashing, and normal tuner operation will resume with the station frequency displayed.

CD PLAYER ERROR CODES

If a problem should develop while operating the CD player, an error code (**ER-1**, **ER-2**, **ER-3**, etc.) may appear on the display panel. This can indicate a number of problems with the unit, including a mechanical error or an error in the microprocessor control of the player. If an error code should appear, try ejecting and re-loading the disc into the player. While the disc is out of the unit, make sure it is clean, undamaged, and loaded correctly (label surface up). You may also try activating the RESET button  on the unit, but this will also erase the time and pre-set memories.

If the suggested measures do not solve the problem, contact an approved warranty station near you for further assistance.

SPECIFICATIONS

| | |
|------------------------|--|
| Size: | 7" W x 2" H x 6-1/2" D 178 mm x 50 mm x 163 mm |
| Operating Voltage: | 12 volts DC, negative ground |
| Output Power: | 160 watts maximum (40 watts x 4 channels) |
| Output Wiring: | Floating-ground type designed for 4 speaker use. Front and rear channels CANNOT be combined (bridged) for use with 2 speakers. RCA low-level outputs (rear channels). |
| Output Impedance: | Compatible with 4/8-ohm speakers. |
| Low-Level Output: | 2.0 volts (2,000 mv.) |
| Tuning Range: | AM:520 - 1,710 kHz. (10 kHz. step) FM:87.5 - 107.9 MHz. (200 kHz. step) |
| Sensitivity: | 2.0 uV |
| FM Stereo Separation: | 35 kHz |
| CD Frequency Response: | 20 - 20,000 Hz. +0 / -3 dB |
| CD Signal/Noise Ratio: | ≥85 dB |
| CD Dynamic Range: | ≥85 dB |
| CD Channel Separation: | ≥60 dB |
| CD Distortion: | 0.2% |

*Specifications are subject to change without notice.

CD CHANGER CONTROLS

Built into this radio are controls to operate an optional CD changer. Please check with your **Ram-page**/Audiovox car stereo specialist or call 1-800-645-4994 for recommendations of the models that will work with this radio.

Adjustment of the audio functions (volume, tone, balance, and fader) for the CD changer operate in the same manner as they do for radio play. The following controls will operate the CD changer when it is installed and connected to this radio. Refer to the owner's manual included with the CD changer for instructions on the installation and correct loading and use of the CD magazine.

35 CHANGER MODE SELECTOR (MODE/AUX)

During radio or CD play, press this button to select operation of the CD changer as shown by **CDC** on the display panel. Disc play will begin and the disc and track number will be shown on the display panel. When the magazine is loaded into the changer, play will begin from the first track of the first disc in the magazine.

36, 37 DISC SELECT (DISC-DN/DISC-UP)

These buttons are used to select the desired disc for play. To advance to a higher number disc, press the DISC-UP button. To return to a lower number disc, press the DISC-DN button. The number of the disc in play, and the track number, will be shown on the display panel.

38 TRACK SELECT (▶▶/◀◀)

The Track Select functions are used to quickly access the beginning of a particular track. Each time the Forward Track Select (▶▶) button is pressed, the next higher track number will be selected as shown on the display panel. Similarly, each time the Backward Track Select (◀◀) button is pressed, the next lower track number will be selected as shown on the display panel.

39 CUE/REVIEW FUNCTIONS (▶▶/◀◀)

High-speed audible search to any section of the disc can be made by the Cue and Review functions. Press and hold the Cue (▶▶) button to advance rapidly in the forward direction (disc symbol rotation speed increases), or the Review (◀◀) button to advance rapidly in the backward direction (disc symbol rotates in the opposite direction).

40 TRACK/DISC SCAN SELECTOR

When the SCAN button is pressed, the **SCN** indication will appear on the display panel, and the first 10 seconds of each track on the selected disc will be played in order. When a desired track is reached, press the SCN button again, and play of the selected track will continue (**SCN** will disappear from the display panel). The Track Scan mode will also be canceled by activating the Repeat or Shuffle Play functions.

When the SCN button is pressed and held for 2 seconds, the **DSN**, disc number and track number indications will appear on the display panel and the first 10 seconds of the first track on each disc in the magazine will be played. When a desired disc is reached, press the SCN button again and play of the selected disc will continue (**DSN --** will disappear from the display panel). The Disc Scan mode will also be canceled by activating the Repeat Play or Shuffle Play functions.

41 DISC/TRACK REPEAT PLAY (REPEAT)

When the REPEAT button is pressed, the **RPT** indication will appear on the display panel and play of the selected track will be continually repeated until the Track Repeat mode is canceled by pressing the RPT button again, or by activating the Scan or Shuffle Play functions.

When the Repeat button is pressed and held for 2 seconds, the **DRT**, disc number and track number indications will appear on the display panel and play of the selected disc will be continually repeated until the Disc Repeat mode is canceled by pressing the RPT button again or by activating the Scan or Shuffle Play functions.

42 DISC/TRACK SHUFFLE PLAY SELECTOR

When the SHUFFLE button is pressed, the **SHF** indication will appear on the display panel and the tracks on the disc will be played in a random, shuffled order. The Track Select button will also select tracks in the shuffled order instead of the normal progression.

When the RND button is pressed and held for 2 seconds, the **DSF**, disc number and track number indications will appear on the display panel and the discs in the magazine will be played in a random, shuffled order, as well as the tracks on each disc. After playing all tracks selected at random from a disc in the magazine, the unit will select another disc at random and play all the tracks on it in a random shuffled order. This will continue from disc-to-disc until the Shuffle Disc mode is deactivated by pressing the SHUFFLE button again, or activating the Scan or Repeat Play functions.

CD CHANGER ERROR CODES

If a problem should develop while operating the CD changer, the following error codes may appear on the display panel.

ER-1: Indicates that there is no magazine loaded in the CD changer.

ER-2: Indicates a problem with the magazine eject function.

ER-3: Indicates an error in the disc loading function.

ER-4: Indicates an error in the disc unloading function.

ER-5: Indicates an error in the magazine position.

ER-6: Indicates an error in the laser pick-up position.

ER-7: Indicates an error in the laser focus on the disc.

In any of these error situations, try ejecting the CD magazine from the changer and make sure the discs are clean, undamaged, and loaded correctly (refer to the Owner's Manual of the CD changer). Re-load the magazine and check for proper operation. You may also try activating the RESET button **34** on the unit, but this will also erase the time and pre-set memories. If the suggested measures do not solve the problem, contact an approved warranty station near you for further assistance.

WIRELESS REMOTE CONTROL OPERATION

The wireless remote control supplied with this model is capable of operating most of the features of the unit from a remote location. Each button on the remote control functions in the same way as the referenced button on the main unit. For optimal operation of the remote control, always aim it toward the Remote Sensor ⑳ on the front panel of the main unit.

- ① **POWER ON-OFF** - See Main Unit ①
- ② **VOLUME CONTROL (VOL▲ /▼)** - See Main Unit ②, ③, ④, ⑤, ⑥ and ⑦.
- ③ **INFRARED SENDER** - Emits infrared signal to radio which is detected by the sensor ⑳ .
- ④ **SELECT BUTTON (S)** - See Main Unit ③, ④, ⑤, ⑥ and ⑦
- ⑤ **MANUAL UP/DOWN TUNING** – See Main Unit ⑪ except press **U** to increase frequency, press **D** to decrease frequency.
- ⑥ **CD TRACK SELECT** – See Main Unit ⑳ and ㉘, except press **TR.UP** to advance to a higher CD track and press **TR.DN** to return to a lower track.
- ⑦ **CD CUE/REVIEW** – See Main Unit ㉚ and ㉜ and CD Track Select above.
- ⑧ **AUTOMATIC STATION SCAN (SCN)** -- See Main Unit ⑫
- ⑨ **MODE SELECT (MOD)** -- See Main Unit ⑱ and ㉝
- ⑩ **PRESET EQUALIZATION (PEQ)** - See Main Unit ⑮
- ⑪ **DISPLAY (DISP)** - See Main Unit ㉞
- ⑫ **AUDIO MUTE (MUT)** – See Main Unit ⑨
- ⑬ **TRACK SCAN** - See Main Unit ㉟ and ㊱
- ⑭ **TRACK/DISC REPEAT (RPT)** - See Main Unit ㊲ and ㊳
- ⑮ **BATTERY COMPARTMENT** - Holds two AAA batteries in rear compartment for remote wireless control operation.
- ⑯ **TRACK/DISC SHUFFLE (SHF)** - See Main Unit ㊴ and ㊵
- ⑰ **RADIO PRE-SET MEMORY 1-6** - See Main Unit ⑮

CD PLAY/PAUSE (PAU) --See Main Unit 29

FM MONO/STEREO SELECT -- See Main Unit 13

LOCAL/DISTANT SELECT -- See Main Unit 17

AUTOMATIC MEMORY STORE (AMS) - See Main Unit 15

BAND/LOUD SELECTOR (BND/LOUD) -- See Main Unit 10 and 8

DISC UP (D.UP) SELECTOR -- See Main Unit 37

DISC DOWN (D.DN) SELECTOR -- See Main Unit 36

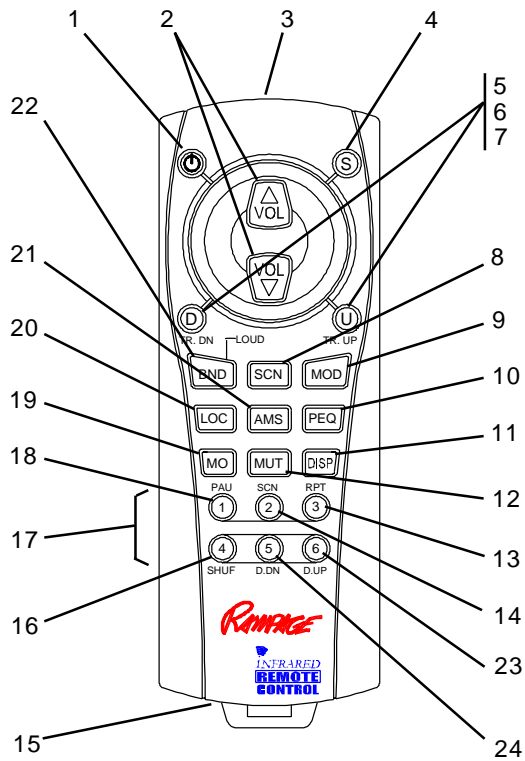

INFRARED REMOTE CONTROL

CARE AND MAINTENANCE

The radio section of your new sound system does not require any maintenance. We recommend that you keep this manual for reference on the many features found in this unit as well as how to set the clock.

The compact disc player section also requires no routine maintenance, but proper understanding of its use and handling will help you obtain maximum enjoyment of its capabilities. The following points should be observed:

- When cleaning the interior of the vehicle, do not get water or cleaning fluids on the unit.
- The CD player is a precision instrument and will not operate properly in extreme heat or cold. In case of such conditions, wait until the interior temperature of the vehicle reaches a normal temperature before using the player.
- If the temperature inside the player gets too hot, a protective circuit will automatically stop play of the disc. In this case, allow the unit to cool off before operating the player again.
- Never insert anything other than a 5" (12 cm) compact disc into the player as the mechanism can be damaged by foreign objects.
- Do not attempt to use 3" (8 cm) CD-Single discs in this unit, either with or without an adaptor, as damage to the player and/or disc may occur. Such damage will not be covered by the Warranty on this product.
- When not using the disc player, always remove the compact disc. Do not leave an ejected disc sitting in the disc slot as this can expose it to sunlight and other causes of damage.
- Do not attempt to open the unit chassis. There are no user serviceable parts or adjustments inside.
- When the vehicle warms up during cold weather or under damp conditions, moisture may condense on the lens of the disc player. Should this occur, the player will not operate properly until the moisture has evaporated.
- The unit is designed with a vibration dampening CD mechanism to minimize interruption of disc play due to normal vibration in a moving vehicle. When driving on very rough roads, however, occasional sound skips may occur. This will not scratch or damage the disc and normal play will resume when the rough conditions cease.

HANDLING COMPACT DISCS

Dirt, dust, scratches, and warpage can cause skips in the playback and deterioration of sound quality. Please follow these guidelines to take care of your compact discs:

- Use only compact discs with the mark 
- Fingerprints, dust, and dirt should be carefully wiped off the disc's playing surface (shiny side) with a soft cloth. Wipe in a straight motion from the inside to the outside of the disc.
- Never use chemicals such as record sprays, household cleaners or thinner to clean compact discs. Such chemicals can irreparably damage the disc's surface.
- Discs should be kept in their storage cases when not in use.
- Do not expose discs to direct sunlight, high temperatures or high humidity for extended periods.
- Do not stick paper, tape, or labels on the disc surfaces nor write on them with any type of marker.

THIS PAGE INTENTIONALLY LEFT BLANK

12 MONTH LIMITED WARRANTY

AUDIOVOX CORPORATION (the Company) warrants to the original retail purchaser of this product that should this product or any part thereof, under normal use and conditions, be proven defective in material or workmanship within 12 months from the date of original purchase, such defect(s) will be repaired or replaced with new or reconditioned product (at the Company's option) without charge for parts and repair labor.

To obtain repair or replacement within the terms of this Warranty, the product is to be delivered with proof of warranty coverage (e.g. dated bill of sale), specification of defect(s), transportation prepaid, to the warranty center at the address shown below.

This Warranty does not extend to the elimination of car static or motor noise, to correction of antenna problems, to costs incurred for installation, removal, or reinstallation of the product, or damage to tapes, compact discs, speakers, accessories, or vehicle electrical systems.

This Warranty does not apply to any product or part thereof which, in the opinion of the Company, has suffered or been damaged through alteration, improper installation, mishandling, misuse, neglect, accident, or by removal or defacement of the factory serial number/bar code label(s). THE EXTENT OF THE COMPANY'S LIABILITY UNDER THIS WARRANTY IS LIMITED TO THE REPAIR OR REPLACEMENT PROVIDED ABOVE AND, IN NO EVENT, SHALL THE COMPANY'S LIABILITY EXCEED THE PURCHASE PRICE PAID BY PURCHASER FOR THE PRODUCT.

This Warranty is in lieu of all other express warranties or liabilities. ANY IMPLIED WARRANTIES, INCLUDING ANY IMPLIED WARRANTY OF MERCHANTABILITY, SHALL BE LIMITED TO THE DURATION OF THIS WRITTEN WARRANTY. ANY ACTION FOR BREACH OF ANY WARRANTY HEREUNDER INCLUDING ANY IMPLIED WARRANTY OF MERCHANTABILITY MUST BE BROUGHT WITHIN A PERIOD OF 30 MONTHS FROM DATE OF ORIGINAL PURCHASE. IN NO CASE SHALL THE COMPANY BE LIABLE FOR ANY CONSEQUENTIAL OR INCIDENTAL DAMAGES FOR BREACH OF THIS OR ANY OTHER WARRANTY, EXPRESS OR IMPLIED, WHATSOEVER. No person or representative is authorized to assume for the Company any liability other than expressed herein in connection with the sale of this product.

Some states do not allow limitations on how long an implied warranty lasts or the exclusion or limitation of incidental or consequential damage so the above limitations or exclusions may not apply to you. This Warranty gives you specific legal rights and you may also have other rights which vary from state to state.

U.S.A.: AUDIOVOX CORPORATION, 150 MARCUS BLVD., HAUPPAUGE, NEW YORK
11788 • 1-800-645-4994

CANADA: CALL 1-800-645-4994 FOR LOCATION OF WARRANTY STATION SERVING
YOUR AREA

Form No. 128-4270E



For Customer Service
Visit Our Website At
www.audiovox.com
Product Information, Photos,
FAQ's, Owner's Manuals

© 2001 Audiovox Electronics Corp., Hauppauge, NY 11788

Printed in China

128-6207

Free Manuals Download Website

<http://myh66.com>

<http://usermanuals.us>

<http://www.somanuals.com>

<http://www.4manuals.cc>

<http://www.manual-lib.com>

<http://www.404manual.com>

<http://www.luxmanual.com>

<http://aubethermostatmanual.com>

Golf course search by state

<http://golfingnear.com>

Email search by domain

<http://emailbydomain.com>

Auto manuals search

<http://auto.somanuals.com>

TV manuals search

<http://tv.somanuals.com>