

RAMPAGE™

OWNER'S MANUAL

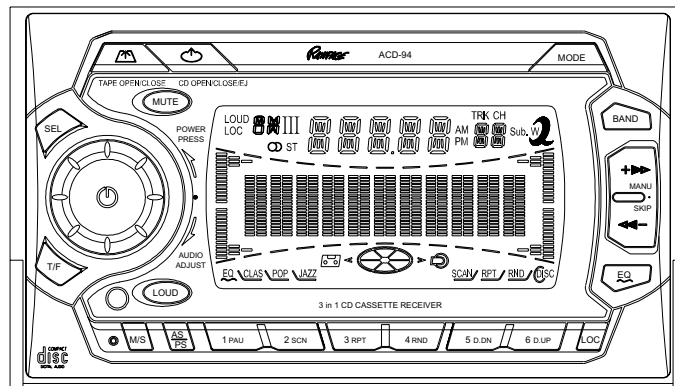

ACD-95

**AM/FM/MPX RADIO WITH MOTORIZED
FOLD-DOWN FRONT PANEL,
COMPACT DISC PLAYER,
AUDIO CASSETTE PLAYER,
CD CHANGER CONTROLS
AND QUARTZ CLOCK**



Released 11-18-02.

128-6566
1 of 20

INSTALLATION INSTRUCTIONS

This unit is designed to fit into a double-DIN dashboard opening (approximately 7.0 x 3.9" (178 x 100 mm)), found in many imported cars. The unit has threaded holes in the chassis side panels which may be used with the original factory mounting brackets of some Toyota, Nissan, Mitsubishi, Isuzu, Hyundai and Honda vehicles to mount the radio to the dashboard. For assistance or answers to installation problems, call Audiovox toll-free at **1-800-645-4994** (Continental U.S./Canada only), or consult with your local car stereo specialist shop.

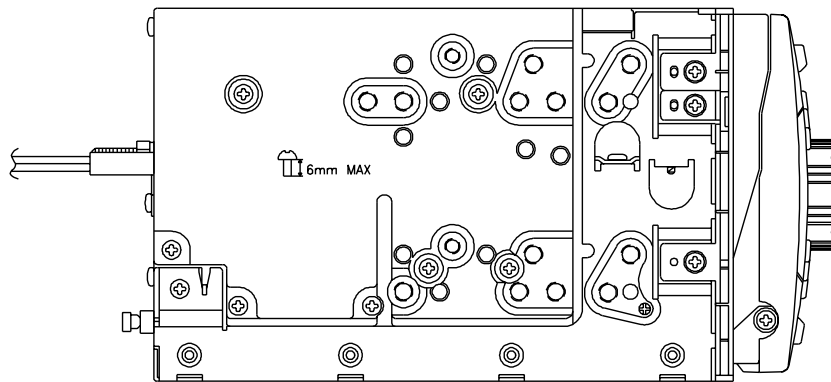

1. Remove the existing factory radio from its dashboard or center console mounting. Save all hardware and brackets as they will be used to mount the new radio.
2. Remove the factory mounting brackets and hardware from the existing radio. Attach the mounting brackets to the new radio using the M5 x 5mm screws supplied with the ACD-95. **DO NOT USE THE SCREWS FROM THE FACTORY RADIO.**

CAUTION: DO NOT EXCEED M5 X 5 MM MAXIMUM SCREW SIZE.
LONGER SCREWS MAY TOUCH AND DAMAGE COMPONENTS
INSIDE THE CHASSIS.

3. In most installations, it is more convenient to complete the wiring before mounting the radio in the dashboard. Follow the wiring diagram carefully and make certain all connections of the wiring harness are secure and insulated with wire nuts or electrical tape to insure proper operation of the unit. After completing the wiring connections, plug the 14-pin connector into the mating socket on the rear of the chassis, attach the front panel, and turn the unit on to confirm operation (ignition switch must be "on"). If unit does not operate, re-check all wiring until problem is corrected. Once proper operation is achieved, turn off the ignition switch, unplug the wiring harness from the chassis, and proceed with final mounting of the chassis.

128-6566
2 of 20

4. Mount the new radio assembly to the dashboard or center console using the reverse procedure of step 1.

CAUTION !

- THE AMPLIFIERS IN THIS RADIO ARE *ONLY* DESIGNED FOR USE WITH 4 SPEAKERS.
- *NEVER* COMBINE (BRIDGE) OUTPUTS FOR USE WITH 2 SPEAKERS.
- *NEVER* GROUND NEGATIVE SPEAKER LEADS TO CHASSIS GROUND.
- FAILURE TO WIRE CORRECTLY MAY CAUSE DAMAGE TO THE RADIO.

**INSTALLATION DIAGRAM
(TYPICAL)**

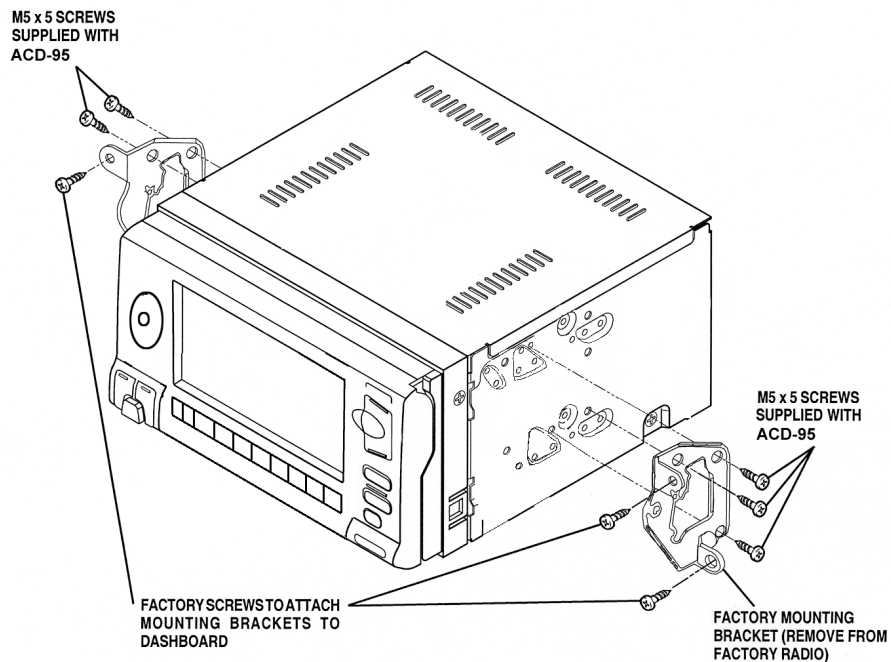

WIRING DIAGRAM

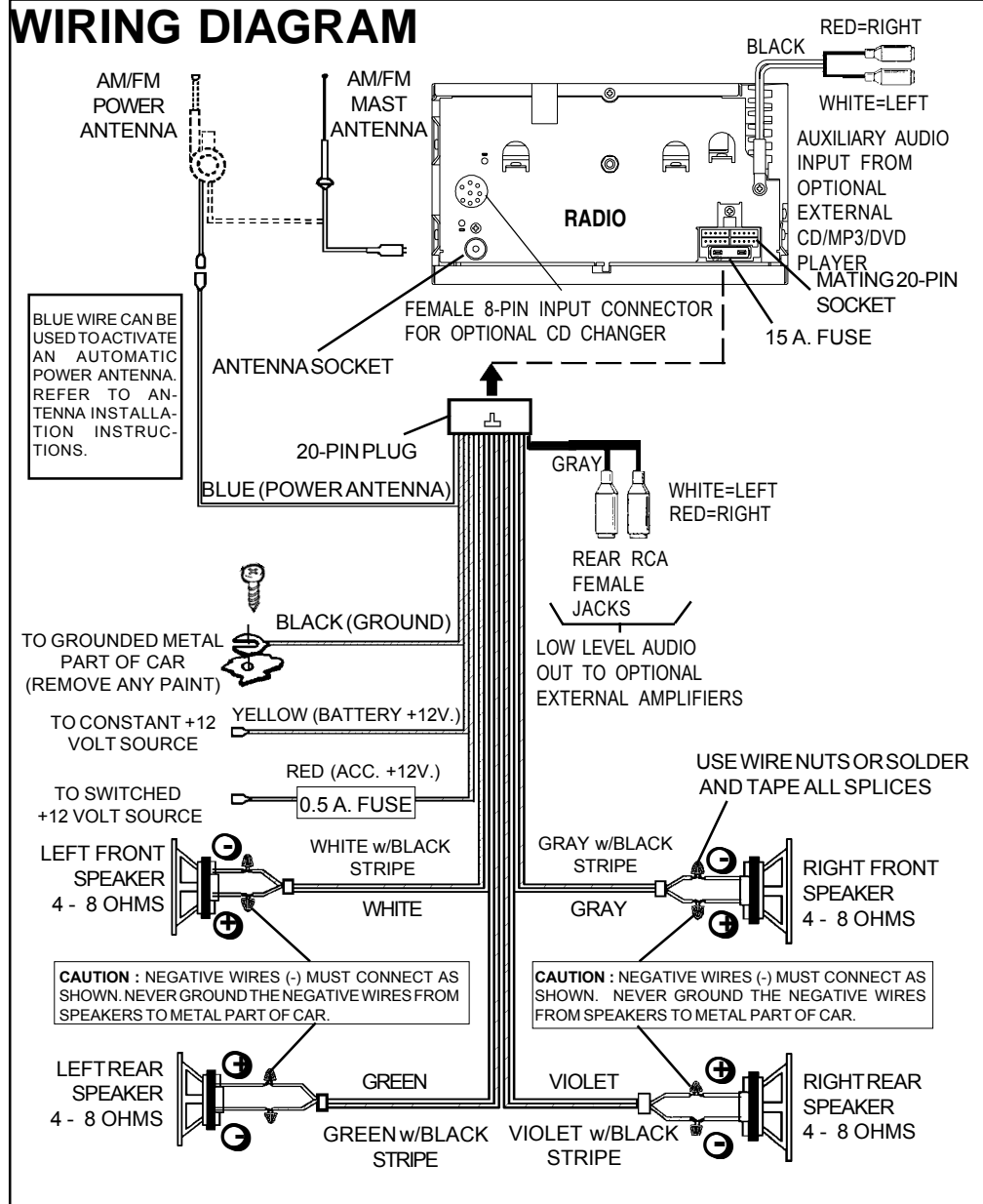

OPERATING INSTRUCTIONS

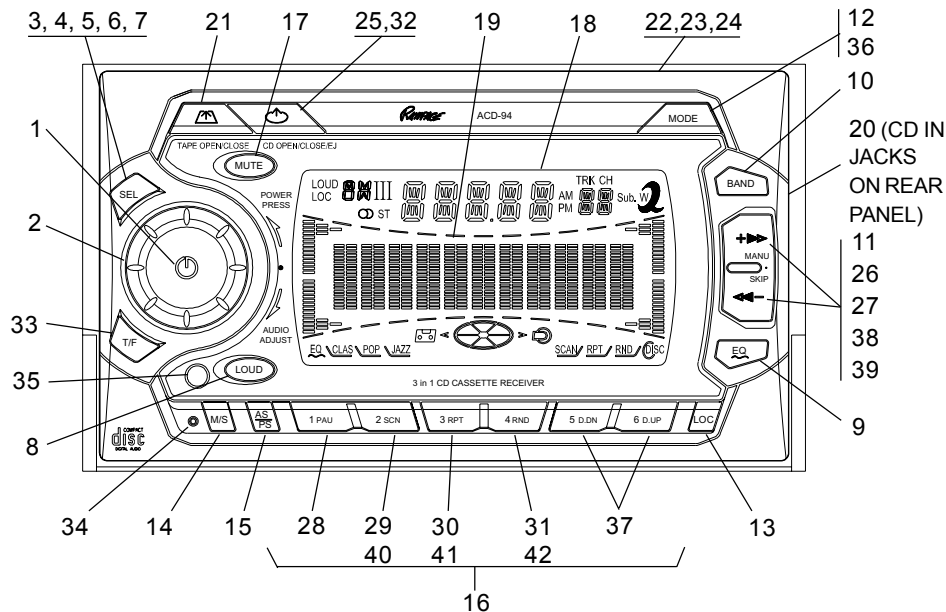

OPERATING INSTRUCTIONS

① POWER PRESS (ON-OFF) BUTTON (⏻)
 Press this button in the center of the AUDIO ADJUST control to turn the unit on or off. If the panel is in the lowered position when the ignition switch is turned off, or if the POWER button is pressed, the panel will automatically rise to the closed position and the unit will then turn off.

② AUDIO ADJUST (LEVEL) CONTROL
 To increase the volume level, turn the AUDIO ADJUST knob clockwise (CW). The volume level will be shown on the display panel from a minimum of **00** to a maximum of **32**. To decrease the volume level, turn the knob counterclockwise (CCW). The display will automatically return to the normal indication 5 sec-

onds after the last volume adjustment or when another function is activated. This control is also used in conjunction with the Select (SEL) control button ③ to adjust the bass, treble, balance and fader levels as described in ④, ⑤, ⑥ and ⑦.

③ SELECT (SEL) CONTROL BUTTON
 This button is used to select the audio function (volume, bass, treble, balance or fade) whose setting is adjusted using the AUDIO ADJUST control 2. Pressing the SEL button once will set the unit for bass adjustment (**BAS** will appear on the display panel). Pressing the button additional times will select treble adjustment (**TRE** on the display), balance (**BAL**), fader (**FAD**) and

volume (**VOL**). The display will automatically return to the normal indication 5 seconds after the last adjustment or when another function is activated.

NOTE: If the Equalizer function ⑨ is active, the **BAS** and **TRE** settings will not be available; they are accessible only when no equalizer setting is present.

④ BASS CONTROL

To adjust the bass level (equalizer function inactive), first select the Bass mode by pressing the SEL button ③ so the **BAS** indication appears on the display panel. Within 5 seconds of choosing the Bass mode, rotate the AUDIO ADJUST control ② counterclockwise (CCW) to decrease the bass response, or CW to increase it as desired. The level will be shown on the display panel from a minimum - 7 to a maximum of + 7 (0 indicates flat response). The display will automatically return to the normal indication 5 seconds after the last adjustment or when another function is activated.

⑤ TREBLE CONTROL

To adjust the treble level (equalizer function inactive), first select the Treble mode by pressing the SEL button ③ so the **TRE** indication appears on the display panel. Within 5 seconds of choosing the Treble mode, rotate the AUDIO ADJUST control ② counterclockwise (CCW) to decrease the treble response, or CW to increase it as desired. The level will be shown on the display panel from a minimum - 7 to a maximum of + 7 (0 indicates flat response). The display will automatically return to the normal indication 5 seconds after the last adjustment or when another function is activated.

⑥ LEFT/RIGHT BALANCE CONTROL

To adjust the left-right speaker balance, first select the Balance mode by pressing the Select button ③ so the **BAL** indication appears on the display panel. Within 5 seconds of choosing the Balance mode, turn the AUDIO ADJUST control ② counterclockwise to adjust the stereo balance to the right channel speakers or clockwise to adjust it to the left channel speakers. The balance position will be shown on the display panel from **R 15** (full right) to **L 15** (full left). When the volume level between the left and right speakers is equal, **BAL - 0** will be shown on the display panel. The display will automatically return to the normal indication 5 seconds after the last adjustment or when another function is activated.

⑦ FRONT/REAR FADER CONTROL

To adjust the front-rear speaker balance, first select the Fader mode by pressing the Select button ③ so the **FAd** indication appears on the display panel. Within 5 seconds of choosing the Fader mode, turn the AUDIO ADJUST control ② counterclockwise to adjust the front-rear speaker balance to the front speakers or clockwise to adjust it to the rear speakers. The fader position will be shown on the display panel from **F 15** (full front) to **F 15** (full rear). When the level between the front and rear speakers is equal, **F - BAL** will be shown on the display panel. The display will automatically return to the normal indication 5 seconds after the last adjustment or when another function is activated.

⑧ LOUDNESS CONTOUR (LOUD)



When listening to music at low volume levels, this feature will boost the bass and treble ranges to compensate for the characteristics of human hearing. Press the LOUD button

momentarily to activate this feature and the indication **LOUD** will appear on the display panel. Pressing the button again momentarily will deactivate the feature (the **LOUD** indication will disappear from the display panel).

9 EQUALIZER BUTTON (EQ)

The EQ button applies preset sound effects to the unit's audio output signal. The EQ button, when pressed, will activate one of the following operating modes (**CLAS**, **POP** or **JAZZ**). If the Equalizer function is active, as displayed on the panel, the bass and/or treble level cannot be set. On the other hand, if the bass and/or treble level(s) are set, and the Equalizer function is activated, the bass/treble setting(s) are ignored. Conversely, when the Equalizer function is not active, the unit returns to the user set bass and treble levels.

10 AM/FM BAND SELECTOR (BAND)

During radio operation, each time this button is pressed, the radio band is changed. The indication **AM I**, **AM II**, **FM I**, **FM II** or **FM III** will appear on the display panel according to your selection. During disc play, pressing this button will stop play of the disc and switch to radio operation. The disc will remain in the machine without being ejected. During this time, the disc symbol icons ( > ) will remain on the display panel to show that a disc is still loaded in the unit. If the BAND button is pressed while a cassette is loaded in the unit, the tape icons (**TAPE**  <) will be displayed, and the cassette will continue to play; to switch to radio operation, press the MODE button. The cassette icons will remain on the display to show that a cassette is still loaded in the unit. Press the MODE button to resume cassette play from the last track in play. When **AM I** or **AM II** is selected, the stereo ( **ST**) indication will disappear from the display.

11 MANUAL (MANU)/SKIP TUNING (+▶>/<<◀-)



To manually select a radio station, momentarily press the Up Tuning (+▶>) side of the button to advance the unit one digit higher or the Down Tuning (<<◀-) side of the button to tune one digit lower.

Pressing and holding either side of the button for longer than 0.5 second will cause the radio to tune rapidly in the selected direction until the next available station and then stop there.

If the radio is in the local (LOC) mode, the radio will tune rapidly in the selected direction until the next strong local station and then stop, thereby skipping the more distant stations.

12 RADIO MODE SELECTION (MODE)

The radio is capable of several modes of operation. Each mode is accessible by pressing the MODE button. This button selects the CD player (**CdP**) playback mode, an optional CD Changer (**CdC**) input, the tape cassette (**TAPE**) playback mode, the auxiliary (**TV**) external audio input, or radio. Each press of the button will select a different mode as indicated on the display panel.

During CD player or cassette player operation, this button may be used to change to CD Changer, radio or TV input (MP3 or external CD player) without ejecting the disc or tape cassette. The >  and/or  < indication will remain on the display panel to show that the CD player and/or cassette player is operational. Press the button again to return to the desired mode.

13 LOCAL SELECTION (LOC)

This feature provides automatic selection of signals at which the radio will stop during Tune/Skip and/or Auto-Store (AS) tuning; thus, only strong (local) stations will be received and selected. Pressing the **LOC** button will cause

LOC icon to disappear from the display panel, and the radio will stop at a wider range of signals, including weaker (more distant) stations.

14 MONO/STEREO SELECTION (M/S)

During FM radio operation, this button is used to select mono or stereo reception of the broadcast signal. Under normal reception conditions, the unit should be left in the stereo mode as indicated by the **ST** indication on the display panel when tuned to an FM stereo signal. If the stereo signal is too noisy for comfortable listening, press the M/S button to switch to monaural reception; the **ST** indication will disappear from the display. To return to stereo reception mode, press the button again so that the **ST** indication reappears on the display.

15 PRE-SET SCAN (PS) / AUTO-STORE TUNING (AS)

Press this button momentarily to scan the stations pre-set into the current AM band or FM band. The unit will stop at each pre-set station for 10 seconds before continuing to the next pre-set station (the pre-set station number on the display panel will flash during Pre-Set Scan operation). Press the button again momentarily to stop Pre-Set Scan operation and remain on the selected frequency.

Pressing and holding the button for longer than 2 seconds will activate the Auto-Store (AS) Tuning feature which will automatically scan and enter up to 6 area stations into the pre-set memories on the band in use. If the radio is in the local mode (**LOC** displayed) the radio will scan and enter only the stronger, more local stations. If you have already set the pre-set memories to your favorite stations, activating the Auto-Store Tuning feature will erase those stations and enter the new ones. This feature

is most useful when traveling in a new area where you are not familiar with the local stations.

16 STATION PRE-SET MEMORIES

To set any of the 6 pre-set memories in each band, use the following procedure:

1. Turn the radio on and select the desired band.
2. Select the first station to be pre-set using the MANU/SKIP or Auto-Store (AS) Controls.
3. Press the pre-set button to be set and continue to hold it in for approximately 2 seconds. The preset number (**CH 1-6**) will appear on the display panel, indicating that the station is now set into that pre-set memory position. The station can now be recalled at any time by pressing that button.
4. Repeat the above procedure for the remaining 5 pre-sets on that band and for the other 4 bands on the unit.

17 AUDIO MUTE (MUTE)

This button is used to mute the volume from the system. By pressing the button, a flashing volume indication will appear on the display panel and the volume will be muted. Pressing the MUTE button again, or activating the Volume Control (2), LOUD button (8), or Equalizer (EQ) button (9) will return the volume level to the setting in use before the Mute function was activated.

18 LIQUID CRYSTAL DISPLAY PANEL

The Liquid Crystal Display (LCD) panel displays the frequency, time, and activated functions.

NOTE: It is a characteristic of LCD panels that, if subjected to cold temperatures for an extended period of time, they may take longer to illuminate than under normal conditions. In addition, the visibility of the numbers on the LCD may slightly decrease. The LCD read-out will return to normal when the temperature increases to a normal range.

19 FUNCTION DISPLAY

The Function Display consists of a left and right 10-section color-coded bar graph; four red, four yellow, and three blue. These sections provide a visual representation of the signal level. The signal level is represented by the number and amplitude of the segments in each graph. As the signal level is increased, the number of illuminated segments will increase and vice-versa.

20 AUXILIARY (AUX) INPUT SELECTION

The radio is equipped with auxiliary audio input connectors which can be interfaced to an external audio source. The connectors are compatible with most CD and cassette players or an MP3 digital audio playback unit. When the external source is connected and the MODE button is pressed to select **TV**, only the external input is played by the radio. No other input sources (radio, cassette or CD) are operative.



21 TAPE OPEN/CLOSE AND CASSETTE DOOR



The cassette door is located behind the front panel; to access the cassette door, momentarily press the TAPE OPEN/CLOSE button (). This causes the front panel to open and fold down to the horizontal position,

thereby allowing room to insert the cassette into the player. Hold the cassette with the exposed tape edge of the side to be played to the right and insert it fully into the cassette door. As the cassette is engaged and begins playing, **TAPE** will appear on the display panel accompanied by the  < symbol; direction of play is animated by a cursor which rotates in a square pattern. Clockwise (CW) rotation indicates left-to-right tape motion, while CCW rotation indicates right-to-left tape motion. When the cassette reaches the end on the side of the tape being played, the unit will automatically change direction of play as shown by the arrow indications on the display panel.

NOTE: Observe cassette operation cautions in the Care and Maintenance Section of this manual.

22 FAST-FORWARD/REWIND BUTTONS

( / )

These buttons cause the tape to move rapidly in the direction indicated by the arrows. For example, if the  button is pushed when the tape is moving from left to right, as indicated by the cursor, the tape will fast-forward. If the  button is pressed while the tape is moving from right to left, the tape will rewind. To stop fast tape movement, lightly push the opposite button. If the tape is allowed to fast-forward or rewind all the way to the end, play will automatically begin again from that point.

23 TAPE PROGRAM SELECTOR

To manually reverse tape direction and play the other side (program) of the cassette, lightly push both the Fast-Forward and Rewind buttons at the same time. The change of direction will be shown by the animated cursor on the display panel.



24 TAPE EJECT BUTTON ()

Tape playback is stopped and the cassette is ejected by pressing this button. The button is

accessible when the front panel of the unit is released to the horizontal fold-down position by pressing the  button (2). Radio operation will automatically resume when the cassette is ejected.

NOTE: Never leave a cassette engaged in the player when not in use. Doing so can cause damage to the cassette and/or mechanism of the unit. Always press the eject button and remove the cassette.

CD OPEN/CLOSE/EJECT (EJ) AND DISC SLOT

The disc slot is located behind the front panel; to access the slot, momentarily press the DISC OPEN/CLOSE/EJ button (). This causes the front panel to open and fold down to the 45° position, thereby allowing room to insert the disc into the player without revealing the cassette door below. With the front panel in this fold-down position, gently insert the disc into the slot (label surface facing up) until the soft-loading mechanism engages and pulls the disc in. The **CdP** indication will momentarily appear on the display. The () indication illuminates and becomes animated, the disc in symbol () appears, and the track number (**TRK 01**) appears on the display panel together with the elapsed playing time.

CAUTION: This unit is designed for play of standard 5" (12cm) compact discs ONLY. Do not attempt to use 3" (8cm) CD-Singles in this unit, either with or without an adapter, as damage to the player and/or disc can occur. Such damage will not be covered by the Warranty on this product.



TRACK SELECT (+▶>/<◀-)

During disc play the Track Select functions are performed by the MANU SKIP buttons. Track select is used to quickly access the beginning of a particular track. Each time the Forward Track Select (+▶>) side of the button is pressed and released, the next higher track number will be selected as shown on the display panel. Similarly, each time the Backward Track Select (<◀-) side of the button is pressed, the next lower track number will be selected as shown on the display panel.

CUE/REVIEW FUNCTIONS (+▶>/<◀-)

During disc play high-speed audible search to any section of the disc can be made by the Cue and Review functions of the MANU SKIP buttons. Press and hold the Cue (+▶>) side of the button to advance rapidly in the forward direction (the advancing disc playing time will be shown on the display panel), or the Review (<◀-) side of the button to advance rapidly in the backward direction (the decreasing disc playing time will be shown on the display panel).

DISC PAUSE BUTTON (PAU)

When a disc is loaded into the player, **CdP** momentarily appears on the display and the  symbol becomes animated. These indications are followed by display of the disc in symbol () and track number (**TRK 01**, etc.) as the disc begins to play. To stop disc play, press the MODE button to return to radio operation. To pause disc player operation, press the PAU button; **PAUSE** will appear on the display panel. To resume disc play, press the PAU button again; **PAUSE** will disappear and disc play will resume from the point at which it was stopped.

29 TRACK SCAN SELECTOR (SCN)

During disc play, press this button to play the first 10 seconds of each track on the disc (**SCAN** will appear on the display panel). When a desired track is reached, press the SCN button again to cancel the function (**SCAN** will disappear from the display panel) and play of the selected track will continue. Scan mode will also be canceled by activating the Repeat Play, Random Play, or track select functions.

30 REPEAT PLAY SELECTOR

During disc play, press this button to repeat the play of the selected track (**RPT** will appear on the display panel). Play of the track will continue to repeat until the button is pressed again and the **RPT** indication disappears from the display panel. Repeat Play mode will also be canceled by activating the Track Scan or Random Play select functions.

31 RANDOM PLAY SELECTOR (RND)

During disc play, press this button to play the tracks on the disc in a random shuffled order (**RND** will appear on the display panel). In Random Play mode, the Track Select function will also select tracks in the random order instead of the normal progression. The Random Play mode can be canceled by pressing the button again (**RND** indication will disappear from the display panel), or by activating the Track Scan or Random Play select functions.

32 DISC EJECT

During CD player operation, disc play is stopped and the disc is ejected when the CD OPEN/CLOSE/EJ (☞) button on the front of the chassis is pressed to fold down the panel to the 45° position, and then pressed and held for at least 2 seconds. Radio or another mode will automatically resume depending on which mode was in operation prior to disc play. If the

disc is not removed from the unit within approximately 15 seconds of being ejected, it will automatically be re-loaded into the unit to prevent it from being accidentally damaged; (>☹ will appear on the display panel to indicate that a disc is still loaded in the player). Play of the disc can be resumed by using the MODE button to choose the CD player function.

33 TIME/FREQUENCY SELECTOR (T/F)

The radio is capable of displaying the time-of-day or the current operating mode, such as frequency. During radio operation, momentarily press this button to call the time display on the quartz clock. The time display colon will be flashing. To return to the current operational mode, press the T/F button again. During integral CD player or cassette player operation, or during CD changer or auxiliary input operation, a press of the button will call the time display, but tape or disc play will continue uninterrupted. The time display will remain until the T/F button is pressed again.

34 RESET BUTTON

A Reset button is accessible in the lower left corner of the front panel and can be used to activate the reset circuitry. However, this feature should only be activated under the following circumstances as it will erase the time and pre-set memories:

1. Upon initial installation after all wiring is completed.
2. If there is a malfunction of any of the switches on the unit, pressing the Reset button may clear the system and permit a return to normal operation.

35 INFRARED SENSOR

Detects infrared command signal from the remote control unit.

CD PLAYER ERROR CODES

INDICATION	CAUSE	SOLUTION
Er-2	Disc loading malfunction	Press RESET button and try again.
Er-3	Disc eject malfunction	Press RESET button and try again.
Er-4	Focus malfunction	Try a different disc. The disc may be damaged or dirty.
Er-5	Tracking malfunction	Try a different disc. The disc may be damaged or dirty.
Er-6	SLED malfunction	Press RESET button and try again.
Er-7	TOC reading malfunction	Try a different disc. The disc may be damaged or dirty.
Er-8	Disc will not play	Press RESET button and try again.

CD CHANGER CONTROLS

Built into this radio are controls to operate an optional CD changer. Please check with your Rampage/Audiovox car stereo specialist or call 1-800-645-4994 for recommendations of the models that will work with this radio.

Adjustment of the audio functions (volume, tone, balance, and fader) for the CD changer operate in the same manner as they do for radio play. The following controls will operate the CD changer when it is installed and connected to this radio. Refer to the owner's manual included with the CD changer for instructions on the installation and correct loading and use of the CD magazine.

36 CD CHANGER MODE SELECTOR (MODE)

During radio or CD play, press this button to select operation of the CD changer as shown by **CdC** on the display panel. Disc play will begin and the disc and track number will be shown on the display panel. When the

magazine is loaded into the changer, play will begin from the first track of the first disc in the magazine.

37 DISC SELECT (D.UP/D.DN)

These buttons are used to select the desired disc for play. To advance to a higher number disc, press the **D.UP** button. To return to a lower number disc, press the **D.DN** button. The number of the disc in play will be shown on the display panel.

38 TRACK SELECT (+▶> / <◀-)

The Track Select functions are used to quickly access the beginning of a particular track. Each time the Forward Track Select (+▶>) side of the button is pressed, the next higher track number will be selected as shown on the display panel. Similarly, each time the Backward Track Select (<◀-) button is pressed, the next lower track number will be selected as shown on the display panel.

39 CUE/REVIEWFUNCTIONS (+▶> / <◀-)

High-speed audible search to any section of the disc can be made by the Cue and Review functions. Press and hold the Cue (+▶>) side of the button to advance rapidly in the forward direction (disc play symbol rotation on the display panel will increase) or the Review (<◀-) side of the button to advance rapidly in the backward direction.

40 TRACK/DISC SCAN SELECTOR (SCN)

When the SCN button is pressed, the **SCAN** indication will appear on the display panel, and the first 10 seconds of each track on the disc will be played in order. When a desired track is reached, press the SCN button again and play of the selected track will continue (**SCAN** will disappear from the display panel). The Track Scan mode will also be canceled by activating the Repeat or Shuffle Play function.

When the SCN button is pressed and held, the **DISC** and **SCAN** indications will appear on the display panel and the first 10 seconds of the first track on each disc in the magazine will be played. When a desired disc is reached, press the SCN button again and play of the selected disc will continue (**DISC** and **SCAN** will disappear from the display panel). The Disc Scan mode will also be canceled by activating the Repeat Play or Random Play functions.

41 DISC/TRACK REPEAT PLAY (RPT)

When the RPT button is pressed, the **RPT** indication will appear on the display panel and play of the selected track will be continually repeated until the Track Repeat mode is canceled by pressing the RPT

button twice or by activating the Scan or Random Play functions.

When the Repeat button is pressed and held, the **DISC** and **RPT** indications will appear on the display panel and play of the selected disc will be continually repeated until the Disc Repeat mode is canceled by pressing the RPT button again or by activating the Scan or Random Play functions.

42 DISC/TRACK RANDOM PLAY (RND)

When the RND button is pressed, the **RND** indication will appear on the display panel and the tracks on the disc will be played in a random, shuffled order. The Track Select button will also select tracks in the shuffled order instead of the normal progression. The Shuffle Track mode can be canceled by pressing the RND button or by activating the Scan or Repeat Play functions.

When the RND button is pressed and held, the **DISC** and **RND** indications will appear on the display panel and the discs in the magazine will be played in a random, shuffled order, as well as the tracks on each disc. After playing all tracks selected at random from a disc in the magazine, the unit will select another disc at random and play all the tracks on it in a random shuffled order. This will continue from disc-to-disc until the Random Disc mode is canceled by pressing the RND button again or by activating the Scan or Repeat Play functions.

CD CHANGER ERROR CODES

If a problem should develop while operating the CD changer, the following error codes may appear on the display panel.

- ER-1:** Indicates that there is no magazine loaded in the CD changer.
- ER-2:** Indicates a problem with the magazine eject function.
- ER-3:** Indicates an error in the disc loading function.
- ER-4:** Indicates an error in the disc un-loading function.
- ER-5:** Indicates an error in the magazine position.
- ER-6:** Indicates an error in the laser pick-up position.
- ER-7:** Indicates an error in the laser focus on the disc.

In any of the above situations, try ejecting the CD magazine from the changer and make sure the discs are clean, undamaged, and loaded correctly (refer to the Owner's Manual of the CD changer). Re-load the magazine and check for proper operation. You may also try activating the **RESET** button (34) on the unit, but this will also erase the time and pre-set memories.

If the suggested measures do not solve the problem, contact an approved warranty station near you for further assistance.

WIRELESS REMOTE CONTROL OPERATION

- ① POWER ON/OFF** - See Main Unit ①.
- ② MODE SELECTOR (MODE)** - See Main Unit ⑫.
- ③ INFRARED SENDER** - Emits infrared signal to radio which is detected by the sensor.
- ④ VOLUME (VOL) CONTROL** - See Main Unit ②.
- ⑤ SELECT BUTTON (SEL)** - See Main Unit ③, ④, ⑤, ⑥, and ⑦.
- ⑥ TUNE/SEEK CONTROL** - See Main Unit ⑪, except press ►► to increase frequency, and press ◄◄ to decrease frequency.
- ⑦ AUDIO MUTE (MUTE)** - See Main Unit ⑰.
- ⑧ EQUALIZER (EQ)** - See Main Unit ⑨.
- MANUAL SEEK TUNING** - See Main Unit ⑪, except press and hold ►► to Seek upward, press and hold ◄◄ to Seek downward.
- CD TRACK SELECT** - See Main Unit ⑲, except press ►► to select a higher track number, press ◄◄ to select a lower track number.
- CD CUE/REVIEW** - See Main Unit ⑲, except press and hold ►► for Cue Function, and press and hold ◄◄ for Review function.

- ⑨ **TRACK/DISC REPEAT (RPT)** - See Main Unit ⑳ and ㉑.
- ⑩ **DISC +/-** - See Main Unit ㉒.
- ⑪ **BATTERY COMPARTMENT** - Holds one 3-Volt Button Cell for remote wireless control operation.
- ⑫ **TRACK/DISC RANDOM (RND)** - See Main Unit ㉓ and ㉔.
- ⑬ **RADIO PRE-SET MEMORY 1-6** - See Main Unit ⑯.
- ⑭ **TRACK/DISC PAUSE (PAU)** - See Main Unit ㉕.
- ⑮ **TRACK/DISC SCAN (SCN)** - See Main Unit ㉖ and ㉗.
- ⑯ **AM/FM BAND(BAND)** - See Main Unit ⑩.

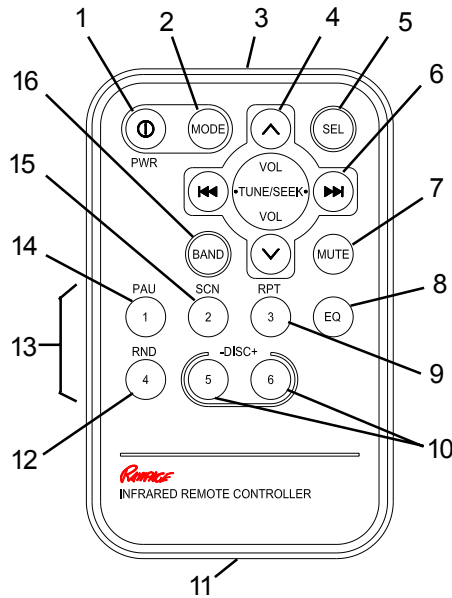

NOTES ON USE OF FRONT PANEL

The front panel can be lowered or slid down to one of two positions:

1. When loading or ejecting an audio cassette, press the button to lower the panel to the horizontal position, thereby leaving adequate room to install the cassette. The front panel will not automatically return to the normal position after the cassette is loaded; press the again to activate the panel to the upright position.
2. When loading a CD, press the button to lower the panel to the 45° position, thereby leaving adequate room to install the disc and, at the same time, not reveal the cassette door below. The front panel will automatically return to the normal upright position after the disc is loaded, and the disc will begin to play.

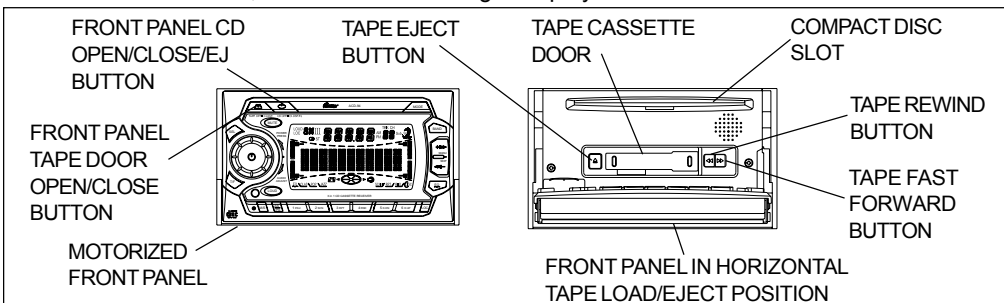

SETTING THE CLOCK

1. Switch the vehicle ignition and radio "on".
2. Press and hold the Time/Frequency (T/F) button to access the time display; the time colon should be flashing.
3. While holding the T/F button, press the Up Tuning (+▶▶) button to adjust the hours and **AM/PM** indication, or the Down Tuning (◀◀-) button to adjust the minutes indication to the correct time. Release the T/F button.
4. The adjusted time display will remain on the LCD until the T/F button is pressed once again to return to the operational mode currently selected.

CARE AND MAINTENANCE

The radio portion of your new sound system does not require any maintenance. We recommend you keep this manual for reference to the many features found in this unit as well as how to set the clock.

The compact disc and cassette player sections also require no routine maintenance, but proper understanding of their use and handling will help you obtain maximum enjoyment of their capabilities. The following points should be observed:

- When cleaning the interior of the vehicle, do not get water or cleaning fluids on the unit.
- The CD player is a precision instrument and will not operate properly in extreme hot or cold. In case of such conditions, wait until the interior temperature of the vehicle reaches a normal temperature before using these players.
- If the temperature inside the players gets too hot, a protective circuit will automatically stop play of the disc. In this case, allow the unit to cool off before operating the player again.
- Never insert anything other than a 5" (12 cm) compact disc into the player as the mechanism can be damaged by foreign objects.
- Do not attempt to use 3" (8 cm) CD-Single discs in this unit, either with or without an adaptor, as damage to the player and/or disc may occur. Such damage will not be covered by the Warranty on this product.
- When not using the disc player, always remove the compact disc. Do not leave an ejected disc sitting in the disc slot as this can expose it to sunlight and other causes of damage.
- Do not attempt to open the unit chassis. There are no user serviceable parts or adjustments inside.
- When the vehicle warms up during cold weather or under damp conditions, moisture may condense on the lens of the disc player. Should this occur, the player will not operate properly until the moisture has evaporated.
- The unit is designed with a vibration dampening CD mechanism to minimize interruption of disc play due to normal vibration in a moving vehicle. When driving on very rough roads, however, occasional sound skips may occur. This will not scratch or damage the disc and normal play will resume when the rough conditions cease.

128-6566
16 of 20

Cassette Care

As with any cassette player, the cassette section of this sound system does require a minimum of maintenance to keep it in good working condition. The following simple care and maintenance suggestions should be followed to prevent malfunctions of the cassette system:

1. Purchase a cassette cleaning kit from your local retail store. Use it! At least every 20 to 30 hours of operation you must clean the cassette mechanism. A dirty cassette player will have a poor sound.
2. Do not use cassettes that exceed 45 minutes of play on each side.
3. Do not insert a cassette that appears to be broken, twisted or dirty, or with loose or torn labels on it.
4. Always keep your cassettes away from direct sunlight or exposure to sub-freezing conditions. If a cassette is cold, allow it to warm up before use.
5. Do not keep a cassette in the player when not in use.
6. Before inserting a cassette in the player, check that the tape is tightly wound on the reels.

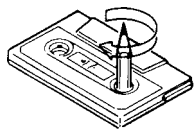

Take up any excess slack using a pencil to turn the drive hub in the cassette (see diagram).

Handling Compact Discs:

Dirt, dust, scratches, and warpage can cause skips in the playback and deterioration of sound quality. Please follow these guidelines to take care of your compact discs:

- Use only compact discs with the mark :



- Fingerprints, dust, and dirt should be carefully wiped off the disc's playing surface (shiny side) with a soft cloth. Wipe in a straight motion from the inside to the outside of the disc.
- Never use chemicals such as record sprays, household cleaners or thinner to clean compact discs. Such chemicals can irreparably damage the disc's surface.
- Discs should be kept in their storage cases when not in use.
- Do not expose discs to direct sunlight, high temperatures or high humidity for extended periods.
- Do not stick paper, tape, or labels on the disc surfaces nor write on them with any type of marker.

SPECIFICATIONS

Size:	3.938" H x 7.0" W x 6.875" D 100.0mm x 177.8mm x 174.63mm
Operating Voltage:	12 Volts DC, Negative Ground
Output Power:	160 Watts Maximum (40 Watts x 4 Channels)
Output Wiring:	Floating-Ground Type Designed for use with 4 Speakers (Front and Rear Channels Cannot be Combined (Bridged) for use with 2 Speakers)
Output Impedance:	Compatible with 4/8-Ohm Speakers
Low-Level Output:	>0.5 Volt (500 mV)
Tuning Range:	AM : 530-1710 kHz (10 kHz Steps) FM : 87.5-108.0 MHz (200 kHz steps)
Sensitivity:	AM : 20 uV FM : <4.0 uV
FM Stereo Separation:	>25 dB
CD Frequency Response:	50-15000 Hz +/- 3dB
CD Signal/Noise Ratio:	>55 dB
CD Channel Separation:	>45 dB
CD Distortion:	0.10%
Tape Frequency Response:	50-10000 Hz
Tape Signal/Noise Ratio:	50 dB
Wow and Flutter:	0.15% VRMS

RAMPAGE

12 / 24 MONTH LIMITED WARRANTY

Applies to automotive radios, radio/tape players, radio/CD players, CD changer

AUDIOVOX CORPORATION (the Company) warrants to the original retail purchaser of this product that should this product or any part thereof, under normal use and conditions, be proven defective in material or workmanship within 12 months from the date of original purchase, such defect(s) will be repaired or replaced with new or reconditioned product (at the Company's option) without charge for parts and repair labor.

To obtain repair or replacement within the terms of this Warranty, the product is to be delivered with proof of warranty coverage (e.g. dated bill of sale), specification of defect(s), transportation prepaid, to an approved warranty station or the Company at the address shown below.

The warranty period will be extended to 24 months from the date of original purchase if the product is installed by an authorized Prestige Audio dealer. To claim warranty service during this extended period, the bill of sale must specify that the product was installed by an authorized Prestige Audio dealer.

This Warranty does not extend to the elimination of externally generated static or noise, to correction of antenna problems, to costs incurred for installation, removal or reinstallation of the product, or to damage to tapes, compact discs, speakers, accessories, or vehicle electrical systems.

This Warranty does not apply to any product or part thereof which, in the opinion of the Company, has suffered or been damaged through alteration, improper installation, mishandling, misuse, neglect, accident, or by removal or defacement of the factory serial number/bar code label(s). THE EXTENT OF THE COMPANY'S LIABILITY UNDER THIS WARRANTY IS LIMITED TO THE REPAIR OR REPLACEMENT PROVIDED ABOVE AND, IN NO EVENT, SHALL THE COMPANY'S LIABILITY EXCEED THE PURCHASE PRICE PAID BY PURCHASER FOR THE PRODUCT.

This Warranty is in lieu of all other express warranties or liabilities. ANY IMPLIED WARRANTIES, INCLUDING ANY IMPLIED WARRANTY OF MERCHANTABILITY, SHALL BE LIMITED TO THE DURATION OF THIS WRITTEN WARRANTY. ANY ACTION FOR BREACH OF ANY WARRANTY HEREUNDER INCLUDING ANY IMPLIED WARRANTY OF MERCHANTABILITY MUST BE BROUGHT WITHIN A PERIOD OF 30 MONTHS FROM DATE OF ORIGINAL PURCHASE. IN NO CASE SHALL THE COMPANY BE LIABLE FOR ANY CONSEQUENTIAL OR INCIDENTAL DAMAGES FOR BREACH OF THIS OR ANY OTHER WARRANTY, EXPRESS OR IMPLIED, WHATSOEVER. No person or representative is authorized to assume for the Company any liability other than expressed herein in connection with the sale of this product.

U.S.A. : AUDIOVOX CORPORATION, 150 MARCUS BLVD., HAUPPAUGE, NEW YORK 11788 (1-800-645-4994)

CANADA : CALL 1-800-645-4994 FOR LOCATION OF WARRANTY STATION SERVING YOUR AREA

128-5543

WARRANTY

19

128-6566
19 of 20



For Customer Service
Visit Our Website At
www.audiovox.com
Product Information, Photos,
FAQ's, Owner's Manuals

© 2002 Audiovox Electronics Corp., 150 Marcus Blvd., Hauppauge, N.Y. 11788

Printed in China

128-6566

128-6566
20 of 20

Free Manuals Download Website

<http://myh66.com>

<http://usermanuals.us>

<http://www.somanuals.com>

<http://www.4manuals.cc>

<http://www.manual-lib.com>

<http://www.404manual.com>

<http://www.luxmanual.com>

<http://aubethermostatmanual.com>

Golf course search by state

<http://golfingnear.com>

Email search by domain

<http://emailbydomain.com>

Auto manuals search

<http://auto.somanuals.com>

TV manuals search

<http://tv.somanuals.com>