

# AUDIOVOX®

## COMPACT DISC PLAYER

### MODEL: # CE170S

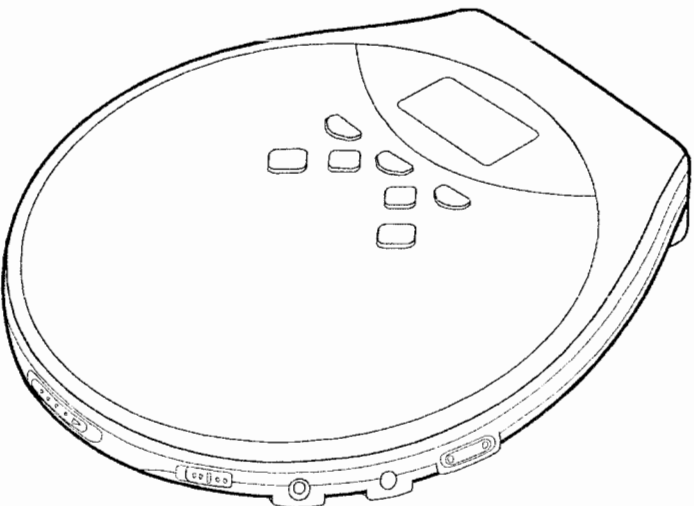

## OPERATING INSTRUCTIONS



**AUDIOVOX™**  
CORPORATION

### 90 DAY LIMITED WARRANTY

*Applies to Audiovox Portable Stereos*

AUDIOVOX CORPORATION (the Company) warrants to the original retail purchaser of this product that should this product or any part thereof, under normal use and conditions, be proven defective in material or workmanship within 90 days from the date of original purchase, such defect(s) will be repaired or replaced with new or reconditioned product (at the Company's option) without charge for parts and repair labor. To obtain repair or replacement within the terms of this Warranty, the product is to be delivered with proof of warranty coverage (e.g. dated bill of sale) specification of defect(s), transportation prepaid, to an approved warranty station. For the location of the nearest warranty station to you, call toll-free to our control office:

**1-800-290-6650**

This Warranty does not extend to the elimination of externally generated static or noise, to correction of antenna problems, to costs incurred for installation, removal, or reinstallation of the product, or damage to tapes, compact discs, speakers, accessories, or electrical systems. This Warranty does not apply to any product or part thereof which, in the opinion of the Company, has suffered or been damaged through alteration, improper installation, mishandling, misuse, neglect, accident, or by removal or detachment of the factory serial number/bar code label(s). THE EXTENT OF THE COMPANY'S LIABILITY UNDER THIS WARRANTY IS LIMITED TO THE REPAIR OR REPLACEMENT PROVIDED ABOVE AND, IN NO EVENT, SHALL THE COMPANY'S LIABILITY EXCEED THE PURCHASE PRICE PAID BY PURCHASER FOR THE PRODUCT.

This Warranty is in lieu of all other express warranties or liabilities. ANY IMPLIED WARRANTIES, INCLUDING ANY IMPLIED WARRANTY OF MERCHANTABILITY, SHALL BE LIMITED TO THE DURATION OF THIS WRITTEN WARRANTY. ANY ACTION FOR BREACH OF ANY WARRANTY HEREUNDER INCLUDING ANY IMPLIED WARRANTY OF MERCHANTABILITY MUST BE BROUGHT WITHIN A PERIOD OF 30 MONTHS FROM DATE OF ORIGINAL PURCHASE. IN NO CASE SHALL THE COMPANY BE LIABLE FOR ANY CONSEQUENTIAL OR INCIDENTAL DAMAGES FOR BREACH OF THIS OR ANY OTHER WARRANTY. EXPRESS OR IMPLIED, WHATSOEVER. No person or representative is authorized to assume for the Company any liability other than expressed herein in connection with the sale of this product. Some states do not allow limitations on how long an implied warranty lasts or the exclusion or limitation of incidental or consequential damage so the above limitations or exclusions may not apply to you. This Warranty gives you specific legal rights and you may also have other rights which vary from state to state.

U.S.A.: AUDIOVOX CORPORATION, HAUPPAUGE, NEW YORK 11788  
CANADA: AUDIOVOX CANADA LTD., MISSISSAUGA, ONTARIO

128-9663

Printed in China  
052CE170S04

## WARNINGS

TO PREVENT FIRE OR SHOCK HAZARDS, DO NOT EXPOSE THIS UNIT TO RAIN OR MOISTURE.



This symbol is intended to alert the user to the presence of uninsulated "dangerous voltage" within the products enclosure that may be of sufficient magnitude to constitute a risk of electric shock to persons.



This symbol is intended to alert the user to the presence of important operating and maintenance ( servicing) instructions in the literature accompanying the appliance.



This product utilizes a Class 1 laser to read Compact Discs. This laser Compact Disc Player is equipped with safety switches to avoid exposures when the CD door is open and the safety interlocks are defeated. Invisible laser radiation is present when the CD Player's lid is open and the system's interlock has failed or been defeated.

It is very important that you avoid direct exposure to the laser beam at all times. Please do not attempt to defeat or bypass the safety switches.

Any use of the controls or an adjustment to the procedures other than those specified herein may result in hazardous radiation.

TO REDUCE THE RISK OF ELECTRIC SHOCK, DO NOT REMOVE COVER (OR BACK). THERE ARE NO USER-SERVICEABLE PARTS INSIDE. PLEASE REFER ANY SERVICING TO QUALIFIED SERVICE PERSONNEL.

### PRECAUTIONS

- Do not open the CD compartment while the CD is rotating.
- Always keep the CD compartment closed when not in use.
- Keep all foreign objects out of the CD compartment.
- If TV or radio interference occurs during operation, move the unit to a different location within the room or building.
- Place the unit on a stable surface. A vibration or shock to the unit can cause the CD mechanism to mistake or skip. If operating the unit under circumstances which may subject the unit to these conditions, utilize the digital Anti-shock.
- Playing some CD's at high volume can cause vibration leading to mistracking. In this case, lower the volume or relocate the speakers further away from the unit.
- Avoid installing the unit in the locations described below:
  - Where it will be in direct contact with water.
  - Where it will be in direct contact with a magnet.
  - Places exposed to direct sunlight or close to heat radiating appliances such as electric heaters.
  - On top of stereo equipment that radiates too much heat.
  - Places lacking ventilation or dusty places.
  - Places subject to constant vibration.
  - Humid or moist places.

### COMPLIANCE WITH FCC REGULATIONS

This equipment has been tested and found to comply with the limits for a Class B digital device, pursuant to Part 15 of the FCC Rules. These limits are designed to provide reasonable protection against harmful Interference in a residential installation. This equipment generates, uses and can radiate radio frequency energy and, if not installed and used in accordance with the instructions, may cause harmful interference to radio communications. However, there is no guarantee that interference will not occur in a particular installation. If this equipment does cause harmful interference to radio or television reception, which can be determined by turning the equipment off and on, the user is encouraged to try to correct the interference by one or more of the following measures :

- Reorientate or relocate the receiving antenna.
- Increase the separation between the equipment and receiver.
- Connect the equipment into an outlet on a circuit different from that to which the receiver is connected.
- Consult the dealer or an experienced radio technician for help.

## 1. LOCATION OF CONTROLS

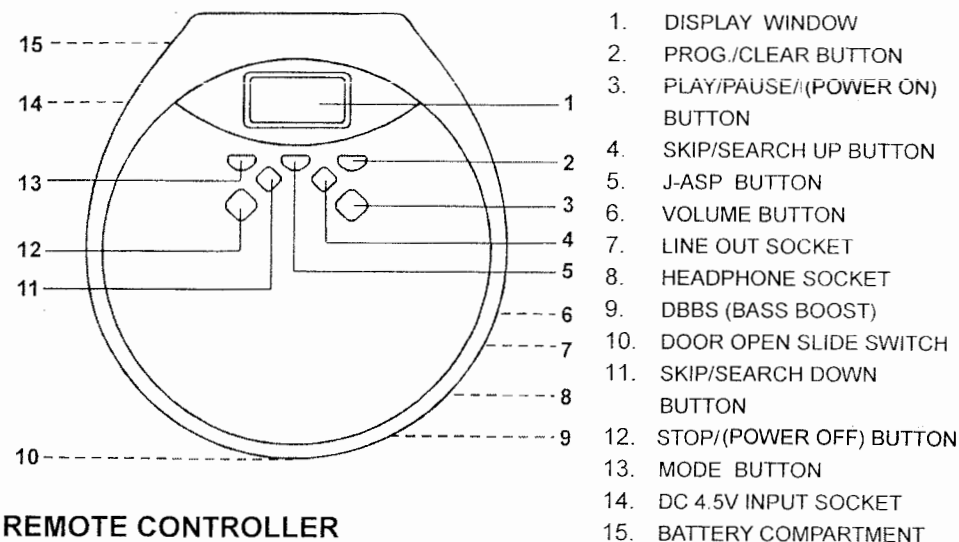

### REMOTE CONTROLLER

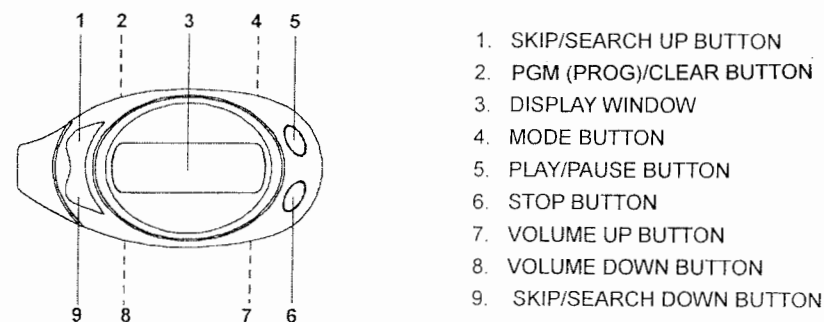

## 2. POWER SOURCES NORMAL BATTERIES/AC ADAPTOR

### Battery Power Operation

1. Open the battery compartment cover and insert two 'AA' alkaline batteries inside the battery compartment. Follow the polarity as indicated on the bottom of the cabinet.
2. Close the battery compartment cover.

Battery Type (using 2 batteries)	Average Playing Time (Normal Play Mode)
Alkaline MN 1500, LR6 or Equivalent	18 Hours
Ni-CAD Rechargeable (min. specification recommended 1.2V-650mA)	5 Hours

Note: Zinc/Carbon, or Zinc/Chloride type batteries are not recommended for this unit as their use will result in extremely short playing times. Wherever possible and for economy it is recommended that the mains adaptor supplied with this unit is used.

### AC Operation

1. Insert the DC plug, at the end of the AC adaptor cord into the DC input socket, at the side of the unit.
2. Plug the AC adaptor into a 120V AC power outlet socket.

**Note:** If the AC plug of this unit does not fit in your AC outlet, a plug adaptor should be used. Consult your local dealer on the type of plug adaptor required.

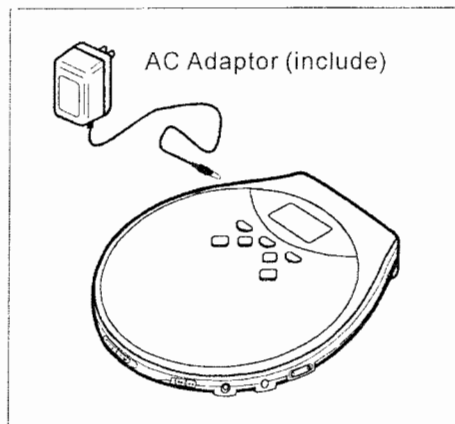

## 3. HEADPHONE AND HI-FI CONNECTION

### Listening with the Headphones

Connect the plug of the stereo Headphones (included) into the PHONES socket.

**Caution:** Avoid excessive volume levels and listening to sound for a long period of time when using headphones.

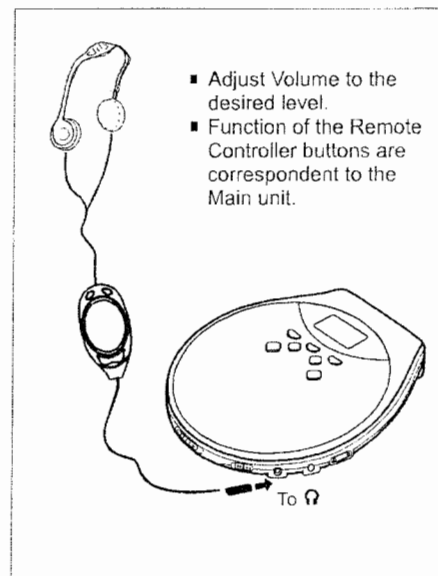

### Connecting to component audio systems

Connect the stereo connection cable (not included) into the LINE OUT (BLACK) socket of the unit and the CD/AUX inputs of an audio system.

**Note:** Always switch the power off before making any connections between the player and another unit.

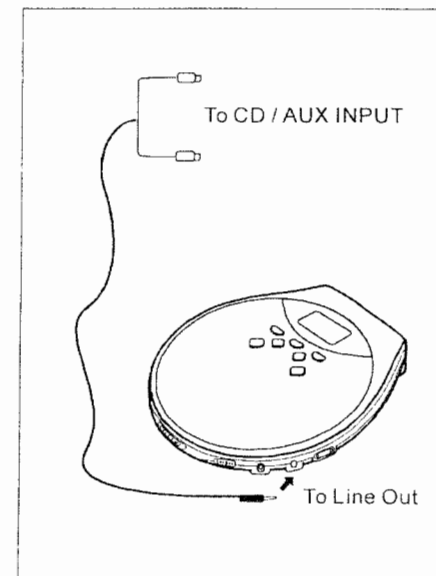

## 4. BASIC DISC PLAY

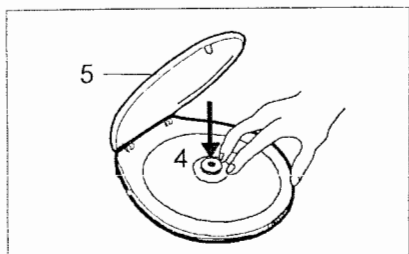
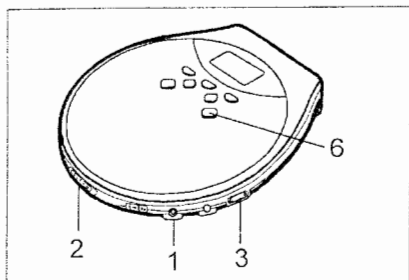

### Remove the disc

Hold the edge and gently press the centre pivot as illustrated, then pick up the disc.

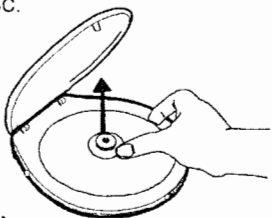

### CAUTION:

Wait for the disc to stop rotating before sliding the OPEN switch.

### NOTE:

Only compact disc marked with the  are guaranteed to work on this player. Home recorded disc's (CDR/CDRW) recorded on home PC's may not play or operate correctly. This unit can play 3" (8cm) single CD's without an adaptor. Do not use a CD single adaptor for these discs.

1. Connect the headphones to the PHONES socket.
2. Slide the OPEN switch to open the CD compartment lid.
3. Adjust the VOLUME to minimum.
4. Insert the disc with the label side Facing up. Push down in the centre until disc is locked in place.
5. Close the lid securely until a click is heard.
6. Press the PLAY button to start playing.

**Note:** J-ASP function will automatically engage.

### To Emphasize the bass sound

Set the BASS BOOST (DBBS) switch to the ON position.

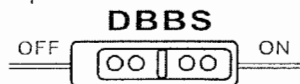

### Note:

The bass boost performance will be dependant on the VOLUME control setting.

### Turning Power on and off

This unit has no ON/OFF switch.

To turn on: Press **▶||** PLAY/PAUSE (playback Starts)

To turn off: Press **■** STOP button once to standby mode. Press **■** STOP button twice, to turn off the power immediately.

### Auto power - off function

When the unit is stopped (standby mode) for approximately 1 minute, the power is automatically turned off.

## 5. LCD DISPLAY INFORMATION

### When the **▶||** is pressed at initial start up

The display will briefly show as fig 1 then proceed to start playback.

To review the total number of tracks on the disc and total disc times, press the STOP button once.

**Note:** The JOGGA buffer will fill automatically if JOGGA function is not required, press J-ASP button to switch if off.

Fig1

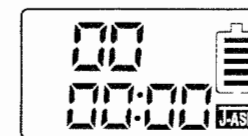

### During PLAY mode

The track number and the elapsed playing Time are displayed.

Track no.



Elapsed time

This sixth track has elapsed 2 min 30sec.

### During PAUSE mode

The track playback is paused, the elapsed time is flashing.



### Note:

When the lid is opened during play mode "OPEN" shows in the display indicating the door is open.

### Note:

A flashing  indication appears on the display when the batteries need to be changed or recharged.

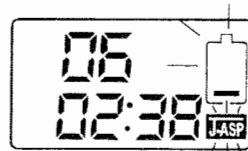

## 6. REPEAT / PLAY MODES

Every time the CD MODE button is pressed. The corresponding mode appears in the display window.

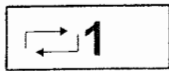
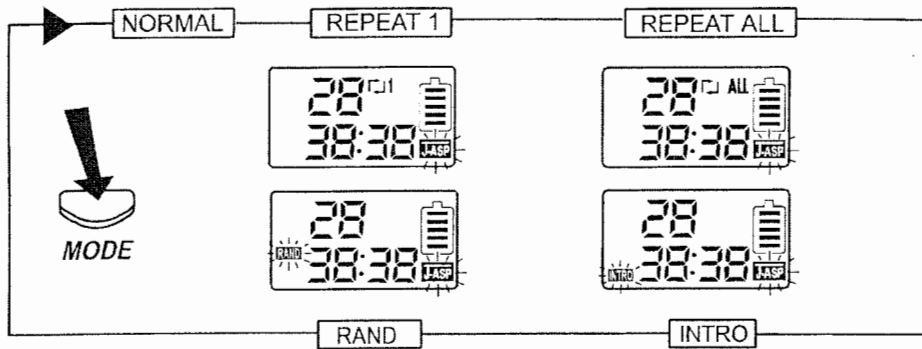

Show on the LCD display. The current track on the disc will be repeated.

During playback

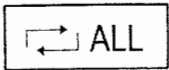
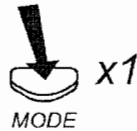

Show on the LCD display. All tracks on the disc will be repeated.

During playback



NOTE: In normal mode none of the above symbols show in the display.

### NORMAL PLAYBACK

Play the whole disc.



Press once to play



## 7. INTRO SCAN AND PROGRAMMED TRACK PLAY

### INTRO

Plays the first 10 second of each track on the disc.

During playback

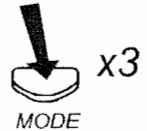

When in the STOP mode press the MODE button three times and then press the PLAY/PAUSE button to start INTRO playback. During disc playback press the MODE button three times and then press the back skip button to start INTRO playback. Alternatively INTRO will start at the end of the current playing track.

### PROGRAMME

This allows selected tracks on the disc to be played in any desired order

#### To set the programme play

Programmes can only be set in the STOP mode.

1. Press the PROG /CLEAR button when the unit is in the stop mode. The track number and indicator appear in the display.
2. Press or to select the desired track.
3. Press the PROG /CLEAR button to enter the track into memory.
4. Repeat step 2 and 3 to programme the order of more tracks up to 24 tracks can be programmed into memory.
5. Press to start the programmed play.
6. To erase the programme, simply pressing the PROG./CLEAR button for 2 seconds in the STOP mode.

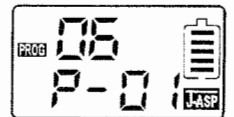

Track no. of the first desired selection

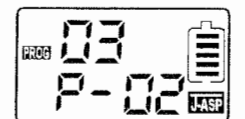

The second selection



## 8. RANDOM PLAY

### RAND

Enables all the tracks on a disc to be played in a Random ( Shuffle ) sequence.

For example : If "RAND" is selected while playing track 8, the random function will commence once track 8 has ended.

When all tracks on a disc have been played the player will automatically stop and power down in approx. 1 minutes to preserve battery life.



During playback



Press MODE button again to return to the NORMAL play mode.

## 9. SKIP AND SEARCH FUNCTIONS

### Locating a Particular track

To skip back to the beginning of the current or a previous track	Press ◀◀ lightly and repeatedly.
To skip to the beginning of following tracks	Press ▶▶ lightly and repeatedly.

### Locating a Particular Point in a track

To search back at a high speed	Keep ◀◀ depressed
To search forward at a high speed	Keep ▶▶ depressed

Low level audio will be heard during the search process to assist in locating correct point in the track.

## 10. FULL SHOCK PROTECTION ( J-ASP )

This player incorporates the latest digital anti shock circuit, which prevents interruption of the sound output if the unit is subjected to shock or vibration during disc playback. The anti shock system will automatically start when a disc is played, J-ASP is shown in the display during start up and J-ASP flashes slowly when the data buffer is full and the JOGGA system is at it's most effective.

### Notes:

1. Whilst the FULL SHOCK (JOGGA) function provides for continuous sound output when the unit is subjected to shock or vibration. It will not correct errors arising from the use of defective scratched or dirty discs.
2. When using the FULL SHOCK (JOGGA) function the battery power consumption increases because the disc rotates faster than normal and the dynamic memory is active.
3. When powering the player solely from batteries, only use the FULL SHOCK (JOGGA) function where necessary to preserve their life.

## 11. PLAYER MAINTENANCE

### Cleaning the Cabinet

Wipe with a soft cloth. If the cabinet is very dirty, dampen the cloth with a weak solution of neutral detergent and water, and then wipe clean.

### Cleaning the Lens

A dirty lens will cause sound skipping and, if the lens is very dirty, the CD may not work. Open the disc cover and clean the lens as follows:

### Dust or Dry Particles

Using a camera lens brush/blower, blow on the lens a couple of times, then wipe it lightly with the brush to remove dust. Then, blow on the lens once more.

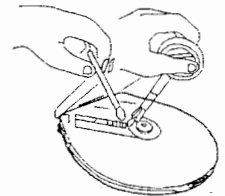

### Finger prints

If the lens cannot be cleaned by using a brush / blower, use a dry cotton swab starting in the middle and working to the outside edge.

## 12. DISC CLEANING AND TROUBLESHOOTING GUIDE

### Cleaning the Disc

When a disc becomes dirty, clean it with a cleaning cloth. Wipe the disc from the centre out.

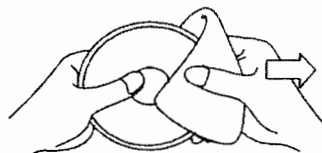

### Note

Do not use solvents such as benzine petrol, thinner, commercially available cleaners or anti-static spray intended for analogue discs.

Should you experience difficulties in the use of this player please refer to the following chart before contacting your dealer or the place of purchase.

Troubleshooting Guide	
Problem	Points to Check
Player fails to function	Disc may be inserted upside down Disc not mounted correctly on chuck Dirty or defective disc Dirty pick up lens Player lid not closed Moisture/Condensation, allow player to warm up to room temperature for 60 minutes AC power to adaptor switched off Weak batteries Auto switch off has occurred
No sound from Headphones	Headphone plug is not firmly inserted into the Black Phones socket. Headphone have been inserted into the Black line output socket.
No sound when played through an external amplifier	Connection is incorrect Power to external amplifier not switched on
Intermittent sound	Dirty or defective disc Dirty pick up lens Player is subject to excessive vibration or shock Low battery power Poor Headphone connection

## 13. PRODUCT SPECIFICATIONS

### PICK-UP

System	Compact disc digital audio system
Laser diode	Material: GaAlAs
Properties	Wavelength : $\lambda = 780\text{nm}$ Emission duration : continuous Laser output : $<44.6 \mu\text{W}$
Error correction	Cross-interleave Reed-solomon code

### AUDIO

D/A conversion	1-bit DAC 8 times oversampling
Frequency response	20-20,000Hz (+1/-3 dB)
Wow and flutter	Below measurable limits
No. of channels	2 channels (stereo)
Output level	Line output : 0.6 Vrms (47 K $\Omega$ ) Headphone " 15 mW (32 $\Omega$ )
Bass boost effect (100Hz)	+6 dB

### GENERAL

Power requirements	- 2 x LR6 "AA" size alkaline battery - DC in 4.5V jack accepts AC power adaptor (centre positive)
Power consumption	0.8W (DC 3V) UNDER NORMAL CONDITION
Dimension	Approx. 130 (W) x (19.5+6.7) (H) x 138 (D) mm
Weight	Approx. 200g not including battery (Main Unit)

## Free Manuals Download Website

<http://myh66.com>

<http://usermanuals.us>

<http://www.somanuals.com>

<http://www.4manuals.cc>

<http://www.manual-lib.com>

<http://www.404manual.com>

<http://www.luxmanual.com>

<http://aubethermostatmanual.com>

Golf course search by state

<http://golfingnear.com>

Email search by domain

<http://emailbydomain.com>

Auto manuals search

<http://auto.somanuals.com>

TV manuals search

<http://tv.somanuals.com>