

**P-945**

**AM/FM/MPX RADIO WITH DETACHABLE FRONT PANEL,  
COMPACT DISC PLAYER, CD CHANGER CONTROLS  
AND QUARTZ CLOCK**



**OWNER'S  
MANUAL**

# **INDEX**

	<b>Page</b>
<i>Operating Instructions</i> .....	3 - 9
<i>Specifications</i> .....	10
<i>CD Changer Controls</i> .....	11
<i>Setting the Clock</i> .....	12
<i>CD Player Error Codes</i> .....	13
<i>CD Changer Error Codes</i> .....	13
<i>Care and Maintenance</i> .....	14
<i>Warranty</i> .....	<i>Inside Back Cover</i>

## OPERATING INSTRUCTIONS

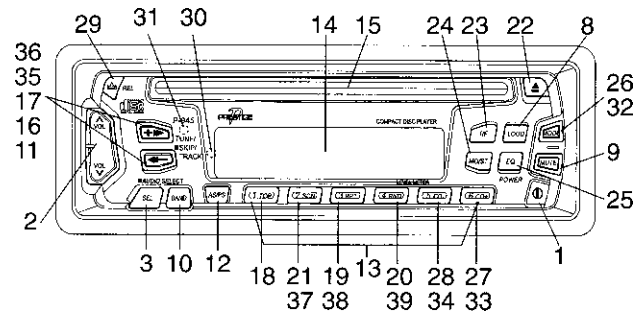

### ① ON/OFF POWER BUTTON

Press this button to turn the unit on or off. If the unit is off and the ignition switch is "on", the unit will turn on automatically when a disc is inserted, or when the "MODE" switch or "BAND" switch is pressed.

### ② VOLUME / LEVEL CONTROL

To increase the volume level, press the  $\wedge$  button. The volume will increase and the level will be shown on the display panel from a minimum of "VOL 00" to a maximum of "VOL 39". To increase the volume quickly, keep the button pressed. To decrease the volume level, press the  $\vee$  button. Keep the button pressed to decrease the volume quickly. The display will automatically return to the normal indication 5 seconds after the last volume adjustment or when another function is activated. These buttons are also used in conjunction with the "AUDIO SELECT" (SEL) button ③ to adjust the bass, treble, balance, and fader levels as described in ④, ⑤, ⑥ and ⑦.

### ③ AUDIO SELECT (SEL) BUTTON

This button is used to select the audio function (volume, treble, bass, balance, or fade) to be adjusted using the Volume/Level Control ②. Pressing the "SEL" button will select bass ("BAS" on the display), treble ("TRE"), balance ("BAL"), fader ("FAD") or volume ("VOL"). The display will automatically return to the normal indication 5 seconds after the last adjustment or when another function is activated. The unit will produce a single beep tone whenever the button is pressed.

### ④ BASS CONTROL

To adjust the bass level, first select the Bass mode by pressing the "SEL" button ③ so that the "BAS" indication appears on the display panel. Within 5 seconds of choosing the Bass mode, press the  $\wedge$  or  $\vee$  button of the Level Control ② to adjust the bass response as desired. The bass level will be shown on the display panel from a minimum of -12 to a maximum of +12 (0 is flat response). The display will automatically return to the

normal indication 5 seconds after the last adjustment or when another function is activated.

### ⑤ TREBLE CONTROL

To adjust the treble level, first select the Treble mode by pressing the "SEL" button ③ so that the "TRE" indication appears on the display panel. Within 5 seconds of choosing the Treble mode, press the ^ or v button of the Level Control ② to adjust the treble response as desired. The treble level will be shown on the display panel from a minimum of -12 to a maximum of +12 (0 is flat response). The display will automatically return to the normal indication 5 seconds after the last adjustment or when another function is activated.

### ⑥ LEFT/RIGHT BALANCE CONTROL

To adjust the left-right speaker balance, first select the Balance mode by pressing the "SEL" button ③ so that the "BAL" indication appears on the display panel. Within 5 seconds of choosing the Balance mode, press the ^ or v button of the Level Control ② to adjust the balance as desired. The set into that pre-set memory position. The balance position will be shown on the display panel from "BAL.L 16" (full left) through "BAL.R 16" (full right). When the volume level between the left and right speakers is equal, "BAL 00" will be shown on the display panel. The display will automatically return to the normal indication 5 seconds after the last adjustment or when another function is activated.

### ⑦ FRONT/REAR FADER CONTROL

To adjust the front-rear speaker balance, first select the Fader mode by pressing the "SEL" button ③ so that the "FAD" indica-

tion appears on the display panel. Within 5 seconds of choosing the Fader mode, press the ^ or v button of the Level Control ② to adjust the front-rear speaker balance as desired. The fader position will be shown on the display panel from "FAD.R 16" (full rear) through "FAD.F 16" (full front). When the level between the front and rear speakers is equal, "FAD 00" will be shown on the display panel. The display will automatically return to the normal indication 5 seconds after the last adjustment or when another function is activated.

### ⑧ LOUDNESS CONTOUR (LOUD)

When listening to music at low volume levels, this feature will boost the bass and treble ranges to compensate for the characteristics of human hearing. Press the "LOUD" button to activate this feature and the indication "LOUD" will appear on the display panel. Pressing the button again will deactivate the feature (the "LOUD" indication will disappear from the display panel).



### ⑨ AUDIO MUTE (MUTE)

This button is used to mute the volume from the system. By pressing the button, a flashing "MUTE" indication will appear on the display panel and the volume will be muted. Pressing the Mute button again, or activating the Volume Control ② Select ("SEL") button ③ "LOUD" button, or Equalizer ("EQ") button will return the volume level to the setting in use before the Mute function was activated.

### ⑩ AM/FM BAND SELECTOR (BAND)

During radio operation, each momentary press of this button will change the radio band. The indication "AM1", "AM2", "FM1", "FM2",

or "FM3" will appear on the display panel according to your selection.

During disc play, pressing this button will stop play of the disc and switch to radio operation without ejecting the disc. During this time, the  IN indication will remain on the display panel to show that a disc is still loaded in the unit. Press the "Mode" button  to return to disc play from the beginning of the last track in play.

### **⑪ MANUAL UP/DOWN TUNING (+ ►► / ◄◄ -) / AUTOMATIC SEEK TUNING**

Each time the + ►► button is tapped, the radio will tune one frequency step higher. Similarly, each tap of the ◄◄ - button will tune one frequency step lower. To manually tune in a station, tap the button of the appropriate direction until the desired frequency is reached.

Pressing either button for longer than 2.0 seconds and then releasing will activate the Automatic Seek Tuning function. The radio will seek the next available station and stop at that frequency. The Seek function can be stopped by pressing the button again or activating any other tuning function.

### **⑫ AUTO-STORE TUNING (AS) / PRE-SET SCAN TUNING (PS)**

During radio operation, press this button momentarily to scan the 6 stations pre-set into the memories of that band. The unit will stop at each pre-set station for 5 seconds before continuing to the next pre-set station. During this time, the pre-set station

number ("CH") in the band will flash. Press the button again momentarily to stop Pre-Set Scan operation and remain on the selected frequency. The station number ("CH") stops flashing.

Pressing the button for longer than 2 seconds will activate the Auto-Store Tuning feature which will automatically scan the band and enter up to 6 strong stations into the 6 pre-set memories. After entering the stations into the memories, the unit will automatically stop at each station for 5 seconds so each can be heard. If you have already set the pre-set memories to your favorite stations, activating the Auto-Store feature will erase those stations and enter the new strong stations. This feature is most useful when travelling in a new area where you are not familiar with the local stations.

### **⑬ STATION PRE-SET MEMORIES**

To set any of the 6 pre-set memories in each band, use the following procedure:



1. Turn the radio on and select the desired band.
2. Select the first station to be pre-set using the Manual Up/Down or Automatic Seek Tuning Controls .
3. Press the pre-set button ("1-6") to be set and continue to hold it in. After approximately 2 seconds, the pre-set number will appear on the display panel, indicating that the station is now set into that pre-set memory position. The station can now be recalled at any time by pressing that button.
4. Repeat the above procedure for the remain in pre-sets on that band and for the other 4 bands on the unit.

#### ⑭ LIQUID CRYSTAL DISPLAY PANEL FUNCTIONS

The Liquid Crystal Display (LCD) panel displays the frequency, time, and all activated functions, including five bar graphs which provide a visual representation of the volume level and the left and right channel balance levels. The volume level is represented by three thin bar graphs. As the volume is increased, the number of illuminated segments will increase. The left and right channels are represented by the wider bar graphs. As the strength of the signal applied to either the left or right channel increases, the number of illuminated segments will increase.

**NOTE:** It is a characteristic of LCD panels that, if subjected to cold temperatures for an extended period of time, they may take longer to illuminate than under normal conditions. In addition, the visibility of the numbers on the LCD may slightly decrease. The LCD read-out will return to normal when the temperature increases to a normal range.

#### ⑮ DISC SLOT

With the label surface facing up, gently insert the disc into the slot until the soft-loading mechanism engages and disc play begins. The  indication illuminates and becomes animated, the  symbol lights, and the track number and elapsed time will appear on the display panel.

**CAUTION:** This unit is designed for play of standard 5" (12cm) Compact Discs ONLY. Do not attempt to use 3" (8cm) CD-Singles in this unit, either with or without an adaptor, as damage to the player and/or disc can occur. Such damage will not be covered by the Warranty on this product.

#### ⑯ TRACK SELECT

These buttons are used to quickly select the beginning of a particular track. With each momentary tap of the Forward Track Select button (+▶▶), the next higher track number will be selected if the button is pressed within one second. Similarly, with each momentary tap of the Backward Track Select button (◀◀-), the next lower track number will be selected if the button is pressed within one second.

#### ⑰ CUE/REVIEW FUNCTIONS

High-speed audible search to any section of the disc can be made by the Cue and Review functions. Press and hold the Cue button (+▶▶) to advance rapidly in the forward direction or the Review button (◀◀-) to advance rapidly in the backward direction. During either function, the elapsed time within each track will automatically be shown on the display panel.

#### ⑱ CD TRACK ONE POSITION (TOP) SELECTOR

During disc play, press this button to return to beginning of first track on disc. Disc counter will return to zero and "TRACK" number 01 will appear on display panel.

#### ⑲ REPEAT PLAY SELECTOR (RPT)

During disc play, press this button to repeat the play of the selected track ("RPT" will appear on the display panel). Play of the track will continue to repeat until the button is pressed again and the "RPT" indication disappears from the display panel. Repeat Play mode will also be cancelled by activating the Random Play ⑳ or Track Scan ㉑ functions.

### ⑳ RANDOM PLAY SELECTOR (RND)

During disc play, press this button to play the tracks on the disc in a random or shuffled order ("RND") will appear on the display panel). In Random Play mode, pressing the Forward Track Select (➡➡) or the Backward Track Select (⏪) will also select tracks in a random order instead of the normal progression. Additional presses will select tracks in random order. The Random Play mode can be cancelled by pressing the button again ("RND" indication will disappear from the display panel) or by activating the Repeat Play ⑲ or Track Scan ㉑ functions.

### ㉑ TRACK SCAN (SCN)

During disc play, press this button to play the first 10 seconds of each track on the disc ("SCAN" will appear on the display panel). When a desired track is reached, press the Scan button again to cancel the function and play of the selected track will continue. Track Scan mode will also be cancelled by activating the Repeat Play ⑲ or Random Play ㉒ functions.

### ㉒ DISC EJECT (▲)

Disc play is stopped, the disc is ejected and the unit will change to radio operation by pressing this button. If the disc is not removed from the unit and the button is pressed again, the disc will be re-loaded.

If the disc is not removed from the disc slot within 15 seconds of being ejected, it will automatically be re-loaded into the unit to prevent it from being accidentally damaged. Play of the disc can be resumed by using the CD Mode Selector ㉓ to choose CD player function.

### ㉓ TIME/FREQUENCY SELECTOR (T/F)

This unit can display the clock time, radio frequency or CD player functions on the display panel. Pressing the Time/Frequency Selector button when the radio frequency or CD player track indication is shown will change the display to show the time. The time display will automatically return to the radio frequency or CD player function indication after 5 seconds.

### ㉔ FM MONO/STEREO SELECTOR (MO/ST)

During FM radio operation, this button is used to select mono or stereo reception of the broadcast signal. Under normal reception conditions, the unit should be left in the stereo mode, as indicated by "ST∞" on the display panel when listening to an FM stereo signal. If the stereo signal is too weak for comfortable listening, press the button to switch to mono reception (the "ST∞" indication will disappear from the display panel). To return to the stereo reception mode, press the button again so that the "ST∞" indication returns.

### ㉕ EQUALIZER SELECTOR (EQ)

The "EQ" button applies preset sound effects to the unit's audio output signal. The "EQ" button, when pressed, will activate one of three operating modes ("ROCK, CLAS, or POP"). When the "EQ" function is active, the bass and treble levels cannot be changed. When the "EQ" function is not active, the unit returns to the user-set bass and treble levels.

### ②⑥ MODE SELECTOR (MODE)

This button is used to select the radio, or the playback mode for the CD player or remote CD changer (if installed). Each press of the button will select a different mode as indicated on the display panel.

During CD player operation, this button may be used to change to radio or remote CD changer mode ("CDC") without ejecting the disc (the  IN indication will remain on the display panel to show that a disc is still loaded in the unit). Press the button again to return to integral CD player mode and resume play of the disc from the point at which it was stopped.

### ②⑦ & ②⑧ DISC SELECT (CD+ & CD-)

These buttons are used to increase or decrease selection of a desired disc for play in the remote CD changer. To advance to a higher number disc, press the "CD+" button ②⑦. To return to a lower number disc, press the "CD-" button ②⑧. The number of the disc in play will be shown on the display panel.

### ②⑨ FRONT PANEL RELEASE BUTTON

This button is used to release the mechanism that holds the front panel to the chassis. To detach the front panel, press the button so that the left side of the panel is released. Grasp the released side and pull it off of the chassis.

To re-attach the panel, position the right side of the panel in place first and then press the left side of the panel until the mechanism locks it into place.

### ③⑩ THEFT-DETERRENT L.E.D.

The theft-deterrent Light Emitting Diode (L.E.D.) is located behind the front panel and is accessible when the front panel is removed. The flashing light serves as a visual warning to the would-be thief that the unit has been disabled by removal of the front panel.

### ③① RESET BUTTON

A "RESET" button is located on the front of the chassis (front panel must be removed to access the button). The "RESET" circuitry is provided to protect the microprocessor circuitry and should only be activated under the following circumstances as it will erase the time and pre-set memories:

1. Upon initial installation after all wiring is completed.
2. After the position of the frequency step switch on the bottom of the chassis has been changed.
3. If there is a malfunction of any of the switches on the unit, pressing the "RESET" button may clear the system and return to normal operation.



### NOTES ON USE OF FRONT PANEL

1. Make sure the front panel is right-side-up when attaching it to the chassis as it cannot be attached when up-side down.
2. Do not press very hard on the front panel when attaching it to the chassis. No more than light to moderate pressure should be needed.
3. When attaching the front panel, make sure the right side is correctly engaged before pressing the left side to lock it into position.
4. When taking the front panel with you, please use the supplied carrying case to protect the panel from dirt and damage. Make sure there is no dust or dirt on the electrical terminals on the back of the panel as this could cause intermittent operation or other malfunctions.

### DETACHING THE FRONT PANEL

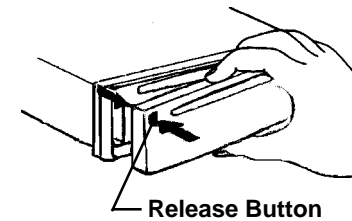

### ATTACHING THE FRONT PANEL

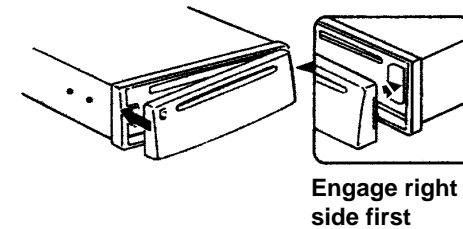

### NOTES ON USE OF REMOTE INPUT JACK

The remote input jack provides the user option of applying an external audio source to the radio.

The audio jack is compatible with most "Walkman" CD and cassette players, or an MP3 digital audio playback unit. When the external source is connected, only that media is played by the radio; no other input sources (radio or CD) are operative.

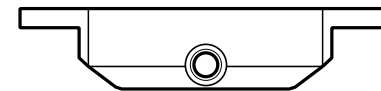

## SPECIFICATIONS

Size:	7" W x 2" H x 6-5/16" D 178 mm x 50 mm x 160 mm
Operating Voltage:	12 volts DC, negative ground
Output Power:	140 watts maximum ( 35 watts x 4 channels)
Output Wiring:	Floating-ground type designed for 4 speaker use. Front and rear channels CANNOT be combined (bridged) for use with 2 speakers. RCA low-level outputs (rear channels).
Output Impedance:	Compatible with 4 ohm speakers.
Low-Level Output:	2.0 volts (2,000 mv.)
Tuning Range:	AM: 530 - 1,710 kHz. (10 kHz. step) FM: 87.5 - 107.9 MHz. (200 kHz. step)
Sensitivity:	< 70 $\mu$ V
FM Stereo Separation:	> 20 dB
CD Frequency Response:	20 - 20,000 Hz. +0 / -3 dB
CD Signal/Noise Ratio:	>85 dB
CD Channel Separation:	>65 dB
CD Distortion:	0.2%

\*Specifications are subject to change without notice.

## CD CHANGER CONTROLS

Built into this radio are controls to operate an optional CD changer. Please check with your Rampage/Audiovox car stereo specialist or call 1-800-645-4994 for recommendations of the models that will work with this radio.

Adjustment of the audio functions (volume, tone, balance, and fader) for the CD changer operate in the same manner as they do for radio play. The following controls will operate the CD changer when it is installed and connected to this radio. Refer to the owner's manual included with the CD changer for instructions on the installation and correct loading and use of the CD magazine.

### ③② CD CHANGER MODE SELECTOR (MODE)

During radio or CD play, press this button to select operation of the CD changer as shown by CDC on the display panel. Disc play will begin and the disc and track number will be shown on the display panel. If a new magazine has been loaded into the changer, play will begin from the first track of the first disc in the magazine. If a magazine was already in the changer, play will resume from the track on the disc previously in play.

### ③③ & ③④ DISC SELECT (CD+ & CD-)

These buttons are used to select the desired disc for play. To advance to a higher number disc, press the CD+ button ③③. To return to a lower number disc, press the CD- button ③④. The number of the disc in play will be shown on the display panel.

### ③⑤ TRACK SELECT (+ ▶▶ / ◀◀ -)

The Track Select functions are used to quickly access the beginning of a particular track. Each time the Forward Track Select (+▶▶) in side of the button is pressed, the next higher track number will be selected as shown on display panel. Similarly, each time the Backward Track Select (◀◀-) side of the button is pressed, the next lower track number will be selected as shown on the display panel.

### ③⑥ CUE/REVIEW FUNCTIONS (+ ▶▶ / ◀◀ -)

High-speed audible search to any section of the disc can be made by the Cue and Review functions. Press and hold the Cue (+▶▶) side of the button to advance rapidly in the forward direction (the disc play symbol will rotate forward on the display panel) or the Review (◀◀-) side of the button to advance rapidly in the backward direction (the disc symbol will rotate backwards on the display panel).

### ③⑦ TRACK/DISC SCAN SELECTOR (SCN)

When the SCN button is pressed, the SCN indication will appear on the display panel, and the first 10 seconds of each track on the disc will be played in order. When a desired track is reached, press the SCN button once and play of the selected track will continue (SCN will disappear from the display panel). The Track Scan mode will also be canceled by activating the (Repeat or Random Play functions).

When the SCN button is pressed twice, the DISC and SCAN indications will appear on the display panel and the first 10 seconds of the first track on each disc in the magazine will be played.

When a desired disc is reached, press the Scan button again and play of the selected disc will continue ( DISC and SCAN will disappear from the display panel). The Disc Scan mode will also be canceled by activating the (Repeat Play or Random Play functions).

### ③⑧ DISC/TRACK REPEAT PLAY (RPT)

When the Repeat button is pressed, the RPT indication will appear on the display panel and play of the selected track will be continually repeated until the Track Repeat mode is canceled by pressing the Repeat button again or by activating the Scan ③⑦ or Random Play ③⑨ functions.

When the Repeat button is pressed twice the DISC and RPT indications will appear on the display panel and play of the selected disc will be continually repeated until the Disc Repeat mode is canceled by pressing the Repeat button again or by activating the Scan ③⑦ or Random Play ③⑨ functions.

### ③⑨ DISC/TRACK RANDOM PLAY (RND)

When the Random button is pressed, the RND indication will appear on the display panel and the tracks on the disc will be played in a random, shuffled order. The Track Select button ③④ will also select tracks in the shuffled order instead of the normal progression. The Random Track mode can be canceled by pressing the Random button again or by activating the Scan ③⑦ or Repeat Play ③⑧ functions.

When the Random button is pressed again, the DISC and RND indications will appear on the display panel and the discs in the magazine will be played in a random, shuffled order, as well as the tracks on each disc. After playing a track selected at random from a disc in the magazine, the unit will select another disc at random and play a randomly selected track on it. This will continue until the Random Disc mode is canceled by pressing the Random button again or by activating the Scan ③⑦ or Repeat Play ③⑧ functions.

---

## SETTING THE CLOCK

---

1. Turn the vehicle ignition and radio "on".
2. Press the Time/Frequency Selector button ②③ to display the time.
3. While the time is being displayed, press the Time /Frequency Selector button ②③ together with the Manual Down Tuning button (◀◀ -) to adjust the hours or the Manual Up Tuning button + ▶▶ to adjust the minutes to the correct time.
4. Five seconds after the last hour or minute adjustment is made, the time will be set in the unit and normal operation can resume.

---

## CD PLAYER ERROR CODES

---

If a problem should develop while operating the CD player, an error code (**ER-1**, **ER-2**, **ER-3**, etc.) may appear on the display panel. This can indicate a number of problems with the unit, including a mechanical error or an error in the microprocessor control of the player. If an error code should appear, try ejecting and re-loading the disc into the player. While the disc is out of the unit, make sure it is clean, undamaged, and loaded correctly (label surface up). You may also try activating the RESET button **(31)** on the unit, but this will also erase the time and pre-set memories.

If the suggested measures do not solve the problem, contact an approved warranty station near you for further assistance.

---

## CD CHANGER ERROR CODES

---

If a problem should develop while operating the CD changer, the following error codes may appear on the display panel.

**ER-1:** Indicates that there is no magazine loaded in the CD changer.

**ER-2:** Indicates a problem with the magazine eject function.

**ER-3:** Indicates an error in the disc loading function.

**ER-4:** Indicates an error in the disc un-loading function.

**ER-5:** Indicates an error in the magazine position.

**ER-6:** Indicates an error in the laser pick-up position.

**ER-7:** Indicates an error in the laser focus on the disc.

In any of the above situations, try ejecting the CD magazine from the changer and make sure the discs are clean, undamaged, and loaded correctly (refer to the Owner's Manual of the CD changer). Re-load the magazine and check for proper operation. You may also try activating the RESET button **(31)** on the unit, but this will also erase the time and pre-set memories.

If the suggested measures do not solve the problem, contact an approved warranty station near you for further assistance.

## CARE AND MAINTENANCE

The radio section of your new sound system does not require any maintenance. We recommend you keep this manual for reference on the many features found in this unit as well as how to set the clock.

The compact disc player section also requires no routine maintenance, but proper understanding of its use and handling will help you obtain maximum enjoyment of its capabilities. The following points should be observed:

- When cleaning the interior of the vehicle, do not get water or cleaning fluids on the unit.
- The CD player is a precision instrument and will not operate properly in extreme hot or cold. In case of such conditions, wait until the interior temperature of the vehicle reaches a normal temperature before using the player.
- If the temperature inside the player gets too hot, a protective circuit will automatically stop play of the disc. In this case, allow the unit to cool off before operating the player again.
- Never insert anything other than a 5" (12 cm) compact disc into the player as the mechanism can be damaged by foreign objects.
- Do not attempt to use 3" (8 cm) CD-Single discs in this unit, either with or without an adaptor, as damage to the player and/or disc may occur. Such damage will not be covered by the Warranty on this product.
- When not using the disc player, always remove the compact disc. Do not leave an ejected disc sitting in the disc slot as this can expose it to sunlight and other causes of damage.

- Do not attempt to open the unit chassis. There are no user serviceable parts or adjustments inside.
- When the vehicle warms up during cold weather or under damp conditions, moisture may condense on the lens of the disc player. Should this occur, the player will not operate properly until the moisture has evaporated.
- The unit is designed with a vibration dampening CD mechanism to minimize interruption of disc play due to normal vibration in a moving vehicle. When driving on very rough roads, however, occasional sound skips may occur. This will not scratch or damage the disc and normal play will resume when the rough conditions cease.

### HANDLING COMPACT DISCS

Dirt, dust, scratches, and warpage can cause skips in the playback and deterioration of sound quality. Please follow these guidelines to take care of your compact discs:

- Use only compact discs with the mark  .
- Fingerprints, dust, and dirt should be carefully wiped off the disc's playing surface (shiny side) with a soft cloth. Wipe in a straight motion from the inside to the outside of the disc.
- Never use chemicals such as record sprays, household cleaners or thinner to clean compact discs. Such chemicals can irreparably damage the disc's surface.
- Discs should be kept in their storage cases when not in use.
- Do not expose discs to direct sunlight, high temperatures or high humidity for extended periods.
- Do not stick paper, tape, or labels on the disc surfaces nor write on them with any type of marker.



## 12 / 24 MONTH LIMITED WARRANTY

*Applies to automotive radios, radio/tape players, radio/CD players, CD changers, power amplifiers, equalizers and accessories.*

AUDIOVOX CORPORATION (the Company) warrants to the original retail purchaser of this product that should this product or any part thereof, under normal use and conditions, be proven defective in material or workmanship within 12 months from the date of original purchase, such defect(s) will be repaired or replaced with new or reconditioned product (at the Company's option) without charge for parts and repair labor.

To obtain repair or replacement within the terms of this Warranty, the product is to be delivered with proof of warranty coverage (e.g. dated bill of sale), specification of defect(s), transportation prepaid, to an approved warranty station or the Company at the address shown below.

The warranty period will be extended to 24 months from the date of original purchase if the product is installed by an authorized Prestige Audio dealer. To claim warranty service during this extended period, the bill of sale must specify that the product was installed by an authorized Prestige Audio dealer.

This Warranty does not extend to the elimination of externally generated static or noise, to correction of antenna problems, to costs incurred for installation, removal or reinstallation of the product, or to damage to tapes, compact discs, speakers, accessories, or vehicle electrical systems.

This Warranty does not apply to any product or part thereof which, in the opinion of the Company, has suffered or been damaged through alteration, improper installation, mishandling, misuse, neglect, accident, or by removal or defacement of the factory serial number/bar code label(s). THE EXTENT OF THE COMPANY'S LIABILITY UNDER THIS WARRANTY IS LIMITED TO THE REPAIR OR REPLACEMENT PROVIDED ABOVE AND, IN NO EVENT, SHALL THE COMPANY'S LIABILITY EXCEED THE PURCHASE PRICE PAID BY PURCHASER FOR THE PRODUCT.

This Warranty is in lieu of all other express warranties or liabilities. ANY IMPLIED WARRANTIES, INCLUDING ANY IMPLIED WARRANTY OF MERCHANTABILITY, SHALL BE LIMITED TO THE DURATION OF THIS WRITTEN WARRANTY. ANY ACTION FOR BREACH OF ANY WARRANTY HEREUNDER INCLUDING ANY IMPLIED WARRANTY OF MERCHANTABILITY MUST BE BROUGHT WITHIN A PERIOD OF 30 MONTHS FROM DATE OF ORIGINAL PURCHASE. IN NO CASE SHALL THE COMPANY BE LIABLE FOR ANY CONSEQUENTIAL OR INCIDENTAL DAMAGES FOR BREACH OF THIS OR ANY OTHER WARRANTY, EXPRESS OR IMPLIED, WHATSOEVER. No person or representative is authorized to assume for the Company any liability other than expressed herein in connection with the sale of this product.

Some states do not allow limitations on how long an implied warranty lasts or the exclusion or limitation of incidental or consequential damage so the above limitations or exclusions may not apply to you. This Warranty gives you specific legal rights and you may also have other rights which vary from state to state.

**U.S.A. :** AUDIOVOX CORPORATION, 150 MARCUS BLVD., HAUPPAUGE, NEW YORK 11788 • 1-800-645-4994

**CANADA :** CALL 1-800-645-4994 FOR LOCATION OF WARRANTY STATION SERVING YOUR AREA

128-5543

---

---

© 2000 Audiovox Corp., 150 Marcus Blvd., Hauppauge, N.Y. 11788

Printed in China

128-5798



## Free Manuals Download Website

<http://myh66.com>

<http://usermanuals.us>

<http://www.somanuals.com>

<http://www.4manuals.cc>

<http://www.manual-lib.com>

<http://www.404manual.com>

<http://www.luxmanual.com>

<http://aubethermostatmanual.com>

Golf course search by state

<http://golfingnear.com>

Email search by domain

<http://emailbydomain.com>

Auto manuals search

<http://auto.somanuals.com>

TV manuals search

<http://tv.somanuals.com>