

**P-153B**

**AM/FM/MPX RADIO WITH FOLD-DOWN  
DETACHABLE FRONT PANEL,  
COMPACT DISC PLAYER,  
AUDIO CASSETTE PLAYER,  
AND QUARTZ CLOCK**



**PRESTIGE**  
by AUDIOVOX

**OWNER'S  
MANUAL**

# **INDEX**

	<b>Page</b>
<i>Operating Instructions</i> .....	3 - 11
<i>Setting the Clock</i> .....	11
<i>CD Player Error Codes</i> .....	12
<i>Care and Maintenance</i> .....	12
<i>Specifications</i> .....	14
<i>Warranty</i> .....	15

# OPERATING INSTRUCTIONS

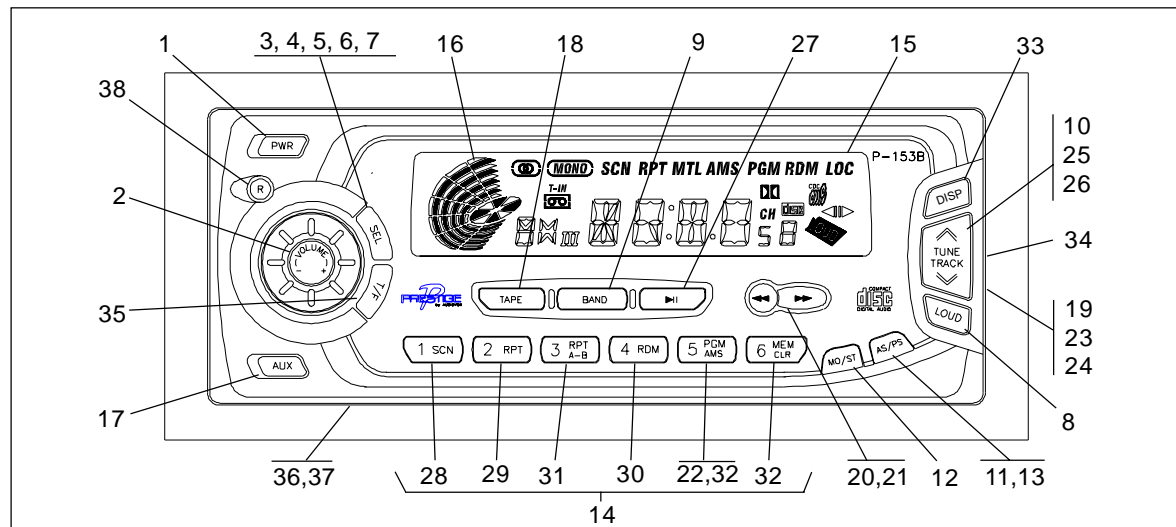

## ① POWER ON-OFF BUTTON ( PWR )

Press this button to turn the unit on or off. If the ignition switch is "on", the unit will turn on automatically when a compact disc or audio cassette is inserted.

## ② AUDIO (LEVEL) CONTROL (VOLUME +/-)

To increase the volume level, turn the VOLUME +/- knob clockwise (+ direction). **VOL** will appear and the volume level will be shown on the display panel from a minimum of **V -- 0** to a maximum of **V -- 46**. To decrease the volume level, turn the knob counter-clockwise (- direction). The display will automati-

cally return to the normal indication 5 seconds after the last volume adjustment or when another function is activated. This control is also used in conjunction with the Select (SEL) control button ③ to adjust the bass, treble, balance and fader levels as described in ④, ⑤, ⑥ and ⑦.

## ③ SELECT (SEL) CONTROL BUTTON

This button is used to select the audio function (volume, bass, treble, balance, or fade) whose setting is adjusted using the VOLUME +/- control ②. Pressing the SEL button once will set the unit for volume (**VOL**) adjustment as described previously.

Pressing the button additional times will select bass adjustment (**BAS** will appear on the display panel) treble adjustment (**TRE** on the display), balance (**BAL**), or fader (**FAD**). The display will automatically return to the normal indication 5 seconds after the last adjustment or when another function is activated.

#### ④ BASS CONTROL

To adjust the bass level, first select the Bass mode by pressing the SEL button ③ so the **BAS** indication appears on the display panel.

Within 5 seconds of choosing the Bass mode, turn the VOLUME +/- control ② counter-clockwise to decrease the bass response or clockwise to increase it as desired. The level will be shown on the display panel from a minimum **B -- 6** to a maximum of **B + 6**. (**B 0** indicates flat response). The display will automatically return to the normal indication 5 seconds after the last adjustment or when another function is activated.

#### ⑤ TREBLE CONTROL

To adjust the treble level, first select the Treble mode by pressing the SEL button ③ so the **TRE** indication appears on the display panel. Within 5 seconds of choosing the Treble mode, turn the VOLUME +/- control ② counter-clockwise to decrease the treble response or clockwise to increase it as desired. The level will be shown on the display panel from a minimum **T -- 6** to a maximum of **T + 6** (**T 0** indicates flat response). The display will automatically return to the normal indication 5 seconds after the last adjustment or when another function is activated.

#### ⑥ LEFT/RIGHT BALANCE CONTROL

To adjust the left-right speaker balance, first select the Balance mode by pressing the Select button ③ so the **BAL** indication appears on the display panel. Within 5 seconds of choosing the Balance mode, turn the VOLUME control ② counter-clockwise to adjust the stereo balance to the left channel speakers or clockwise to adjust it to the right channel speakers. The balance position will be shown on the display panel from **L 12** (full left) to **R 12** (full right). When the volume level between the left and right speakers is equal, **C 00** will be shown on the display panel. The display will automatically return to the normal indication 5 seconds after the last adjustment or when another function is activated.

#### ⑦ FRONT/REAR FADER CONTROL



To adjust the front-rear speaker balance, first select the Fader mode by pressing the Select button ③ so the **FAD** indication appears on the display panel. Within 5 seconds of choosing the Fader mode, turn the VOLUME control ② counter-clockwise to adjust the front-rear speaker balance to the rear speakers or clockwise to adjust it to the front speakers. The fader position will be shown on the display panel from **R 12** (full rear) to **FAD F 12** (full front). When the level between the front and rear speakers is equal, **C 00** will be shown on the display panel. The display will automatically return to the normal indication 5 seconds after the last adjustment or when another function is activated.

#### ⑧ LOUDNESS CONTOUR (LOUD)

When listening to music at low volume levels, this feature will boost the bass and treble ranges to compensate for the

characteristics of human hearing. Press the LOUD button momentarily to activate this feature and the indication **LOUD** will appear on the display panel. Pressing the button again momentarily will deactivate the feature (the **LOUD** indication will disappear from the display panel).

### ⑨ **AM/FM BAND SELECTOR (BAND)**

During radio operation, each time this button is pressed, the radio band is changed. The indication **AM I**, **AM II**, **FM I**, **FM II** or **FMIII** will appear on the display panel according to your selection. During disc or audio cassette play, pressing this button will stop play of the disc or cassette and switch to radio operation. The disc and/or cassette will remain in the machine without being ejected. During this time, the  and/or **T-IN**  icons will remain on the display panel to show that a disc and/or tape cassette is still loaded in the unit. Press the disc play/pause (▶||) button to return to disc play from the beginning of the last track in play, or press the TAPE button to return to cassette play from the beginning of the last track in play.

When AM I or AM II is selected, the stereo (∞) indication will disappear from the display.

### ⑩ **MANUAL UP/DOWN TUNING (▲ / ▼) / AUTOMATIC SEEK TUNING**

To manually select a radio station, momentarily press the Up Tuning (▲) side of the button to advance the unit two digits higher or the Down Tuning (▼) side of the button to tune two digits lower.

Pressing either side of the button for longer than 0.5 second and then releasing will activate the Automatic Seek Tuning function. The radio will seek the next station in the selected direction and stop and remain at that frequency.

Pressing and holding either side of the button for longer than 0.5 second will cause the radio to continue tuning rapidly in the selected direction until the next available station and momentarily stop there. Tuning in the same direction will continue unless the button is released at the desired station.

### ⑪ **LOCAL SELECTION (LOC)**

This feature provides automatic selection of signals at which the radio will stop during Auto-Store (AS) tuning; thus, only strong (local) stations will be received and selected. When Auto-Store (AS) tuning is not in effect, **LOC** will disappear from the display panel, and the radio will stop at a wider range of signals, including weaker (more distant) stations.

### ⑫ **MONO/STEREO SELECTION (MO/ST)**

During FM radio operation, this button is used to select mono or stereo reception of the broadcast signal. Under normal reception conditions, the unit should be left in the stereo mode as indicated by the ∞ indication on the display panel when tuned to an FM stereo signal. If the stereo signal is too noisy for comfortable listening, press the MO/ST button to switch to monaural reception (the ∞ indication will disappear from the display). To return to stereo reception mode, press the button again so that the ∞ indication reappears on the display.

### ⑬ PRE-SET SCAN (PS) / AUTO-STORE TUNING (AS)

Press this button momentarily to scan the stations pre-set into each AM band and each FM band. The unit will stop at each pre-set station for 10 seconds before continuing to the next pre-set station (the pre-set station number on the display panel will flash during Pre-Set Scan operation). Press the button again momentarily to stop Pre-Set Scan operation and remain on the selected frequency.

Pressing and holding the button for longer than 2 seconds will activate the Auto-Store (AS) Tuning feature which will automatically scan and enter up to 6 local area stations into the pre-set memories on the band in use. **LOC** will be displayed during station selection. If you have already set the pre-set memories to your favorite stations, activating the Auto-Store Tuning feature will erase those stations and enter the new local ones. This feature is most useful when traveling in a new area where you are not familiar with the local stations.

### ⑭ STATION PRE-SET MEMORIES

To set any of the 6 pre-set memories in each band, use the following procedure:

1. Turn the radio on and select the desired band.
2. Select the first station to be pre-set using the TUNE/TRACK or Auto-Store (AS) Controls.
3. Press the pre-set button to be set and continue to hold it in for approximately 2 seconds. The pre-set number (**CH 1-6**)

will appear on the display panel, indicating that the station is now set into that pre-set memory position. The station can now be recalled at any time by pressing that button.

4. Repeat the above procedure for the remaining 5 pre-sets on that band and for the other 4 bands on the unit.

### ⑮ LIQUID CRYSTAL DISPLAY PANEL

The Liquid Crystal Display (LCD) panel displays the frequency, time, and activated functions.

**NOTE:** It is a characteristic of LCD panels that, if subjected to cold temperatures for an extended period of time, they may take longer to illuminate than under normal conditions. In addition, the visibility of the numbers on the LCD may slightly decrease. The LCD read-out will return to normal when the temperature increases to a normal range.

### ⑯ FUNCTION DISPLAY



The Function Display consists of a seven-section semi-circular bar graph, with each section containing nine segments which provide a visual representation of the volume level. The volume level is represented by the number of segments in each graph. As the volume is increased, the number of illuminated segments will increase.

### ⑰ AUXILIARY (AUX) INPUT SELECTION

The radio is equipped with auxiliary audio input connectors



which can be interfaced to an external audio source. The connectors are compatible with most CD and cassette players or an MP3 digital audio playback unit. When the external source is connected and the AUX button is pressed, only that media is played by the radio; no other input sources (radio, cassette or CD) are operative.

### ⑱ TAPE PLAYER SELECTOR (TAPE)

This button is used to select the audio cassette player playback mode. When a cassette is loaded in the unit (**T-IN**  displayed) and the button is pressed, the **TAPE** indication also appears on the display and the tape begins play from the point at which it was stopped. A second press of the button will initiate the tape pause mode, and **PAUS** will appear on the display. To exit audio cassette play mode, press the BAND button (radio play) or the CD play/ pause (  ) button (CD play).

During integral CD player operation, this button may be used to change to tape play without ejecting the disc. The  indication will remain on the display panel to show that the disc is still loaded in the unit.



### ⑲ CASSETTE DOOR

Open and fold down the front panel of the unit. Hold the cassette with the exposed tape edge of the side to be played to the right and insert it fully into the cassette door (**TAPE** will appear on the display panel accompanied by the **T-IN**  symbol, and play direction arrow (  or  ), as the cassette is engaged and begins playing). When the cassette reaches the end on the side of the tape being played, the unit will automatically change

direction of play as shown by the arrow indications on the display panel.

**NOTE:** Observe cassette operation cautions in the Care and Maintenance section of this manual.



### ⑳ FAST-FORWARD/REWIND BUTTONS ( / )

These buttons cause the tape to move rapidly in the direction indicated by the arrows. For example, if the  button is pushed when the tape is moving from left to right (  on the display panel), the tape will fast-forward. If the button is pressed while the tape is moving from right to left (  on the display panel), the tape will rewind. To stop fast tape movement, lightly push the opposite button. If the tape is allowed to fast-forward or rewind all the way to the end, play will automatically begin again from that point.

### ㉑ TAPE PROGRAM SELECTOR

To manually reverse tape direction and play the other side (program) of the cassette, lightly push both the Fast-Forward and Rewind buttons at the same time. The change of direction will be shown by the arrows on the display panel.

### ㉒ AUTOMATIC MUSIC SEARCH (AMS)

During tape play, automatic music search allows you to skip to the beginning of another song or piece of music. To initiate music search, press the PGM/AMS button to begin search; **AMS** will appear at the top of the display. Then press the fast forward (  ) or rewind (  ) buttons to skip to another piece of music or

song, as desired. To exit the AMS mode, press the PGM/AMS button. AMS will disappear from the display.

### ②③ EJECT BUTTON (▲)

Tape playback is stopped and the cassette is ejected by pressing this button. The button is accessible when the front panel of the unit is released to the fold-down position. Radio operation will automatically resume when the cassette is ejected.

**NOTE:** Never leave a cassette engaged in the player when not in use. Doing so can cause damage to the cassette and/or mechanism of the unit. Always press the eject button and remove the cassette before removing the detachable front panel.

### ②④ DISC SLOT

With the front panel in the fold-down position, gently insert the disc into the slot (label surface facing up) until the soft-loading mechanism engages and pulls the disc in. The **LOAD** indication will momentarily appear on the display. The (  ) indication illuminates and becomes animated, and the track number ( **T -- 1** ) will appear on the display panel.

**CAUTION:** This unit is designed for play of standard 5" (12cm) compact discs ONLY. Do not attempt to use 3" (8cm) CD-Singles in this unit, either with or without an adapter, as damage to the player and/or disc can occur. Such damage will not be covered by the Warranty on this product.

### ②⑤ TRACK SELECT (▲ / ▼)

During disc play the Track Select functions are performed by the TUNE TRACK button; track select is used to quickly access the beginning of a particular track. Each time the Forward Track Select (▲) side of the button is pressed and released, the next higher track number will be selected as shown on the display panel. Similarly, each time the Backward Track Select (▼) side of the button is pressed, the next lower track number will be selected as shown on the display panel.

### ②⑥ CUE/REVIEW FUNCTIONS (▲ / ▼)

During disc play high-speed audible search to any section of the disc can be made by the Cue and Review functions of the TUNE TRACK button. Press and hold the Cue (▲) side of the button to advance rapidly in the forward direction (the advancing disc playing time will be shown on the display panel), or the Review (▼) side of the button to advance rapidly in the backward direction (the decreasing disc playing time will be shown on the display panel).

During either function, the elapsed time within each track will automatically be shown on the display panel.

### ②⑦ DISC PLAY/PAUSE BUTTON (▶||)

When a disc is loaded into the player, **LOAD** momentarily appears on the display and the  symbol lights. These indications are followed by display of the disc track number ( **T -- 1**, etc.) as the disc begins to play. To stop disc play, press the BAND button



(radio) or the CDC button (CD changer). To return to disc player operation, press the ►|| button; to pause disc player operation, press the ►|| button again; **PAUS** will appear on the display.

### ②⑧ TRACK SCAN SELECTOR (SCN)

During disc play, press this button to play the first 10 seconds of each track on the disc (**SCN** will appear on the display panel). When a desired track is reached, press the SCN button again to cancel the function (**SCN** will disappear from the display panel) and play of the selected track will continue. Scan mode will also be canceled by activating the Repeat Play (including A-B), Random Play, or track select functions.

### ②⑨ REPEAT PLAY SELECTOR (RPT A-B)

During disc play, press this button to repeat the play of the selected track (**RPT** will appear on the display panel). Play of the track will continue to repeat until the button is pressed again and the **RPT** indication disappears from the display panel. Repeat Play mode will also be canceled by activating the Track Scan, Random Play or track select functions.

### ③⑩ RANDOM PLAY SELECTOR (RDM)

During disc play, press this button to play the tracks on the disc in a random shuffled order (**RDM** will appear on the display panel). In Random Play mode, the Track Select function will also select tracks in the random order instead of the normal progression. The Random Play mode can be canceled by pressing the button again (**RDM** indication will disappear from the display panel).

### ③① REPEAT SELECTION (RPT A-B)

During disc play, the RPT A-B button allows you to continuously repeat a specific selection of music/voice on the disc. This may entail portions of the same track, a complete track, or several specific tracks.

To set the beginning point (A) of the segment, press the RPT A-B button during play of the segment in question. **RPT** appears at the top of the display, and **A** appears after the track number and elapsed time at the bottom of the display. After listening to the complete segment, press the RPT A-B button again to set the end point (B); **b** appears after the track number on the display. The chosen selection of the track or tracks will repeat over and over until the RPT A-B button is pressed again. **RPT** and **b** disappear from the display.

### ③② PROGRAM CD TRACKS (PGM/MEM CLR)

During disc play, the programming function can select up to 24 CD tracks to play in any order. Program works by allowing you to select a track number for each spot in the playing sequence.

To begin programming, select a desired track number on the disc by using the TUNE TRACK button; this initiates an up/down scroll of the CD tracks. When the desired track is found, press the MEM/CLR button for less than 1 second to enter the track number into memory. **M -- 01** will appear on the display. Repeat this procedure for each of the other 23 selected tracks in the desired order. **M -- 02-24** will appear on the display.

To play the CD tracks in the programmed order, press the PGM button. **PGM** will appear on the display, and the tracks on the CD(s) will play in the desired order.

To clear the programmed CD tracks, press the MEM CLR button for more than 3 seconds. **M -- CL** will appear on the display and the programmed tracks will be erased.

### ③③ DISPLAY (DISP) BUTTON

During disc play, the elapsed time of the current track is displayed when this button is pressed once; when pressed a second time, the remaining playing time on the current track will be displayed. Pressing the button again (a third time) will revert to the track number display.

### ③④ DISC EJECT (▲)

During CD player operation, disc play is stopped and the disc is ejected when the front panel is folded down and this button on the front of the chassis is pressed. Radio or CD changer operation will automatically resume depending on which mode was in operation prior to disc play. If the disc is not removed from the unit within approximately 10 seconds of being ejected, it will automatically be re-loaded into the unit to prevent it from being accidentally damaged (  will appear on the display panel to indicate that a disc is loaded in the player). Play of the disc can be resumed by using the play/pause (▶||) button to choose CD player function.

### ③⑤ TIME/FREQUENCY SELECTOR (T/F)

During radio operation, press this button to call the time display on the quartz clock. The display will return to the radio frequency indication after 5 seconds.

During integral CD player or cassette player operation, or during CD changer operation, a press of the button will call the time display, but tape or disc play will continue uninterrupted. If the time of day is not adjusted within 5 seconds, the display will return to the play mode currently in effect.

### ③⑥ THEFT-DETERRENT LED

Located on the chassis behind the front panel, a Light Emitting Diode (LED) will flash when the panel is removed. The flashing light serves as a visual warning to the would-be thief that the unit has been disabled by removal of the front panel.

### ③⑦ RESET BUTTON

A RESET button is also accessible behind the front panel and can be used to activate the reset circuitry. However, this feature should only be activated under the following circumstances as it will erase the time and pre-set memories:

1. Upon initial installation after all wiring is completed.
2. If there is a malfunction of any of the switches on the unit, pressing the RESET button may clear the system and permit a return to normal operation.

### ③⑧ FRONT PANEL RELEASE BUTTON (R)

This button is used to release the mechanism that holds the front panel to the chassis. To detach the front panel, press the button so that the panel drops to the lowered position. Press the RELEASE bar at the front edge of the panel and slide the panel off of the front mounting plate. After removing the panel, push the front mounting plate back up to the vertical position.

### **NOTES ON USE OF FRONT PANEL**

1. Make sure the front panel is oriented correctly when sliding it into the front mounting plate, as it cannot be attached when up-side down. Use moderate pressure to fully seat the panel into position.
2. To verify correct panel installation, swing the panel assembly up into position until it locks easily into place. If any resistance is encountered, re-check panel orientation in chassis mounting plate.

**NOTE:** When the faceplate is in the upright position, press the release button to lower the faceplate away from the radio chassis.

3. When taking the front panel with you, please use the supplied carrying case to protect the panel from dirt and damage. Make sure there is no dust or dirt on the electrical terminals on the back of the panel as this could cause intermittent operation or other malfunctions.

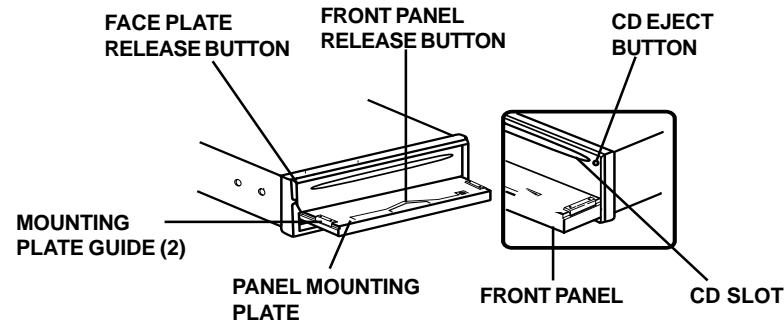

---

### **SETTING THE CLOCK**

---

1. Switch the vehicle ignition and radio "on".
2. Press and release the Time/Frequency button to access the time display; then press and hold the T/F button until the time colon begins to flash.
3. With the time colon flashing, press the Down Tuning (  $\nabla$  ) button to adjust the hours and **AM/PM** indication, or the Up Tuning (  $\blacktriangle$  ) button to adjust the minutes indication to the correct time.
4. Five seconds after the last hour or minute adjustment is made, the time will be set into the unit and the display will return to the normal indication.

## CD PLAYER ERROR CODES

INDICATION	CAUSE	SOLUTION
Er-2	Disc loading malfunction	Press RESET button and try again.
Er-3	Disc eject malfunction	Press RESET button and try again.
Er-4	Focus malfunction	Try a different disc. The disc may be damaged or dirty.
Er-5	Tracking malfunction	Try a different disc. The disc may be damaged or dirty.
Er-6	SLED malfunction	Press RESET button and try again.
Er-7	TOC reading malfunction	Try a different disc. The disc may be damaged or dirty.
Er-8	Disc will not play	Press RESET button and try again.

### ***CARE AND MAINTENANCE***

The radio portion of your new sound system does not require any maintenance. We recommend you keep this manual for reference to the many features found in this unit as well as how to set the clock.

The compact disc player section also requires no routine maintenance, but proper understanding of its use and handling will help you obtain maximum enjoyment of its capabilities. The following points should be observed:

- When cleaning the interior of the vehicle, do not get water or cleaning fluids on the unit.
- The CD player is a precision instrument and will not operate properly in extreme hot or cold. In case of such conditions, wait until the interior temperature of the vehicle reaches a normal temperature before using the player.
- If the temperature inside the player gets too hot, a protective circuit will automatically stop play of the disc. In this case, allow the unit to cool off before operating the player again.

- Never insert anything other than a 5" (12 cm) compact disc into the player as the mechanism can be damaged by foreign objects.
- Do not attempt to use 3" (8 cm) CD-Single discs in this unit, either with or without an adaptor, as damage to the player and/or disc may occur. Such damage will not be covered by the Warranty on this product.
- When not using the disc player, always remove the compact disc. Do not leave an ejected disc sitting in the disc slot as this can expose it to sunlight and other causes of damage.
- Do not attempt to open the unit chassis. There are no user serviceable parts or adjustments inside.
- When the vehicle warms up during cold weather or under damp conditions, moisture may condense on the lens of the disc player. Should this occur, the player will not operate properly until the moisture has evaporated.
- The unit is designed with a vibration dampening CD mechanism to minimize interruption of disc play due to normal vibration in a moving vehicle. When driving on very rough roads, however, occasional sound skips may occur. This will not scratch or damage the disc and normal play will resume when the rough conditions cease.

As with any cassette player, the cassette section of this sound system does require a minimum of maintenance to keep it in good working condition. The following simple care and maintenance suggestions should be followed to prevent malfunctions of the cassette system.

### Cassette Care:

1. Purchase a cassette cleaning kit from your local retail store. Use it! At least every 20 to 30 hours of operation you must clean the cassette mechanism. A dirty cassette player will have a poor sound.
2. Do not use cassettes that exceed 45 minutes of play on each side.
3. Do not insert a cassette that appears to be broken, twisted or dirty or with loose or torn labels on it.
4. Always keep your cassettes away from direct sunlight or exposure to sub-freezing conditions. If a cassette is cold, allow it to warm up before use.
5. Do not keep a cassette in the player when not in use.
6. Before inserting a cassette in the player, check that the tape is tightly wound on the reels.

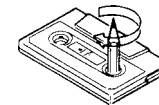

Take up any excess slack using a pencil to turn the drive hub in the cassette (see diagram).

### Handling Compact Discs:

Dirt, dust, scratches, and warpage can cause skips in the playback and deterioration of sound quality. Please follow these guidelines to take care of your compact discs:

- Use only compact discs with the mark : 
- Fingerprints, dust, and dirt should be carefully wiped off the disc's playing surface (shiny side) with a soft cloth. Wipe in a straight motion from the inside to the outside of the disc.

- Never use chemicals such as record sprays, household cleaners or thinner to clean compact discs. Such chemicals can irreparably damage the disc's surface.
- Discs should be kept in their storage cases when not in use.
- Do not expose discs to direct sunlight, high temperatures or high humidity for extended periods.
- Do not stick paper, tape, or labels on the disc surfaces nor write on them with any type of marker.

## SPECIFICATIONS

Size: 3.375" H x 8.375" W x 6.125" D  
85.73mm x 212.73mm x 155.57mm

Operating Voltage: 12 Volts DC, Negative Ground

Output Power: 160 Watts Maximum  
(40 Watts x 4 Channels)

Output Wiring: Floating-Ground Type Designed for use  
with 4 Speakers  
(Front and Rear Channels **Cannot** be  
Combined (Bridged) for use with 2  
Speakers)

Output Impedance: Compatible with 4/8-Ohm Speakers

Low-Level Output: 2.0 Volts (2000 mV)

Tuning Range: AM : 530-1720 kHz (10kHz Steps)  
FM : 87.5-107.9MHz (200kHz steps)

Sensitivity: AM : 20 uV  
FM : 3.0 uV

FM Stereo Separation: 30 dB

CD Frequency Response: 20-20000 Hz +/- 3dB

CD Signal/Noise Ratio: 70 dB

CD Channel Separation: 60 dB

CD Distortion: 0.10%

Tape Frequency Response: 50-10000 Hz

Tape Signal/Noise Ratio: 50 dB

Wow and Flutter: 0.15% VRMS



## 12 / 24 MONTH LIMITED WARRANTY

*Applies to automotive radios, radio/tape players, radio/CD players, CD chang-*

AUDIOVOX CORPORATION (the Company) warrants to the original retail purchaser of this product that should this product or any part thereof, under normal use and conditions, be proven defective in material or workmanship within 12 months from the date of original purchase, such defect(s) will be repaired or replaced with new or reconditioned product (at the Company's option) without charge for parts and repair labor.

To obtain repair or replacement within the terms of this Warranty, the product is to be delivered with proof of warranty coverage (e.g. dated bill of sale), specification of defect(s), transportation prepaid, to an approved warranty station or the Company at the address shown below. The warranty period will be extended to 24 months from the date of original purchase if the product is installed by an authorized Prestige Audio dealer. To claim warranty service during this extended period, the bill of sale must specify that the product was installed by an authorized Prestige Audio dealer.

This Warranty does not extend to the elimination of externally generated static or noise, to correction of antenna problems, to costs incurred for installation, removal or reinstallation of the product, or to damage to tapes, compact discs, speakers, accessories, or vehicle electrical systems.

This Warranty does not apply to any product or part thereof which, in the opinion of the Company, has suffered or been damaged through alteration, improper installation, mishandling, misuse, neglect, accident, or by removal or defacement of the factory serial number/bar code label(s). THE EXTENT OF THE COMPANY'S LIABILITY UNDER THIS WARRANTY IS LIMITED TO THE REPAIR OR REPLACEMENT PROVIDED ABOVE AND, IN NO EVENT, SHALL THE COMPANY'S LIABILITY EXCEED THE PURCHASE PRICE PAID BY PURCHASER FOR THE PRODUCT.

This Warranty is in lieu of all other express warranties or liabilities. ANY IMPLIED WARRANTIES, INCLUDING ANY IMPLIED WARRANTY OF MERCHANTABILITY, SHALL BE LIMITED TO THE DURATION OF THIS WRITTEN WARRANTY. ANY ACTION FOR BREACH OF ANY WARRANTY HEREUNDER INCLUDING ANY IMPLIED WARRANTY OF MERCHANTABILITY MUST BE BROUGHT WITHIN A PERIOD OF 30 MONTHS FROM DATE OF ORIGINAL PURCHASE. IN NO CASE SHALL THE COMPANY BE LIABLE FOR ANY CONSEQUENTIAL OR INCIDENTAL DAMAGES FOR BREACH OF THIS OR ANY OTHER WARRANTY, EXPRESS OR IMPLIED, WHATSOEVER. No person or representative is authorized to assume for the Company any liability other than expressed herein in connection with the sale of this product.

**U.S.A. :** AUDIOVOX CORPORATION, 150 MARCUS BLVD., HAUPPAUGE, NEW YORK 11788 • 1-800-645-4994

**CANADA :** CALL 1-800-645-4994 FOR LOCATION OF WARRANTY STATION SERVING YOUR AREA

128-5543



For Customer Service  
Visit Our Website At  
**[www.audiovox.com](http://www.audiovox.com)**  
Product Information, Photos,  
FAQ's, Owner's Manuals

---

---

© 2000 Audiovox Corp., 150 Marcus Blvd., Hauppauge, N.Y. 11788

Printed in China

128-6411



## Free Manuals Download Website

<http://myh66.com>

<http://usermanuals.us>

<http://www.somanuals.com>

<http://www.4manuals.cc>

<http://www.manual-lib.com>

<http://www.404manual.com>

<http://www.luxmanual.com>

<http://aubethermostatmanual.com>

Golf course search by state

<http://golfingnear.com>

Email search by domain

<http://emailbydomain.com>

Auto manuals search

<http://auto.somanuals.com>

TV manuals search

<http://tv.somanuals.com>