

INSTALLATION INSTRUCTIONS  
FOR  
**50-0210F-002 SERIES 1181291**  
**50-0210F-003 SERIES 1181292**  
**50-0210F-004 SERIES 1181293**  
SUBURBAN  
OVERHEAD CONSOLE for use with FLIPDOWN VIDEO SYSTEM



These instructions are intended for use only by experienced professionals in the automotive customizing business. Special tools and equipment, as well as specialized handling and care of product during installation, may be required. Before beginning this installation, carefully read through the following instructions. **Use extreme care when cutting headliner material.** Check for wiring or other componentry above headliner material. Cut only where indicated.

Materials/ Tools required for this installation:

1. #2 Phillips screwdriver
2. Powered screwdriver or drill with adapter
3. T-45 TORX bit driver
4. Razor knife or similar
5. Awl or similar tool
6. 1/4" hex socket bit
7. 7/64" drill bit
8. Small chisel
9. Audiovox Series 640/650 Video Module

**FOR USE IN VEHICLES WITH FACTORY INSTALLED  
OVERHEAD CONSOLE ONLY.**

# MATERIALS PROVIDED FOR INSTALLATION:

ITEM	Description	QTY
1	SCREW, # 8 X 3/4" HWH ,TEK,Z1	4
2	SCREW, # 8 X 2 1/2" PFH ,ZII	3
3	SCREW, # 8 X 1 1/4" PWH ,BZ	4
4	CONSOLE	1
5	MOUNTING BRACKET	1
6	REAR LIGHT	1
7	REAR LIGHT TRIM	1
8	PLYWOOD, 3/8" X 6" X 14"	1
9	SCREW, # 6 X 1/2"	10
10	SCREW, 6-32 X 3/4"	6
11	WASHER, 3.5 mm	4

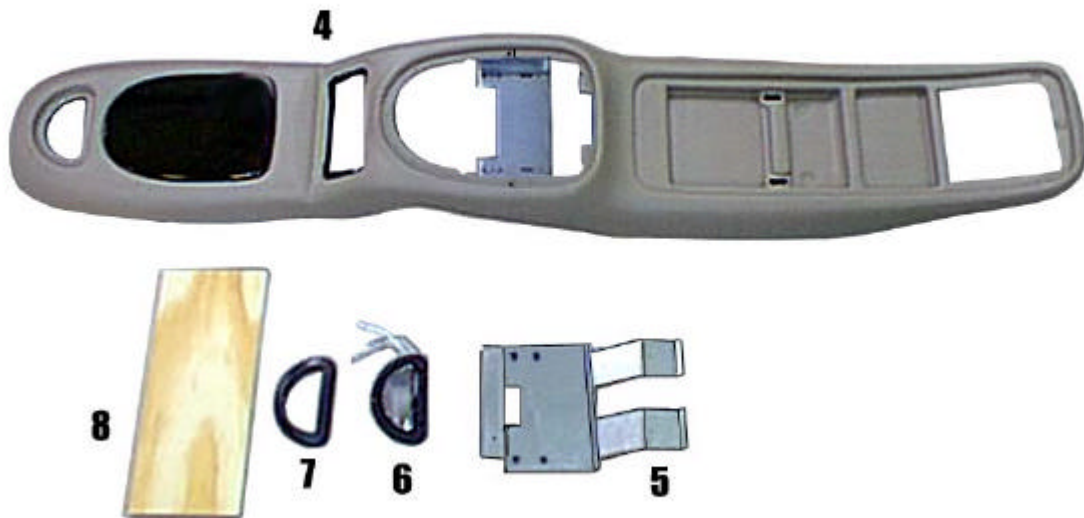
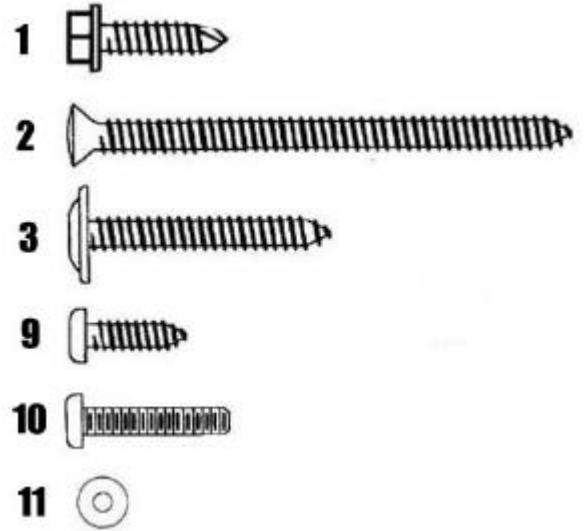

## I. PREPARATION OF VEHICLE INTERIOR

1. Remove the O.E.M. compartment console currently mounted to inner roof of vehicle. Remove (1) one # 8 X 1 3/4" screw from recess in front of console near rear view mirror. Pull front of O.E.M. console down to access wiring. Disconnect all wiring from console. Pull console forward to release rear retainers from inner roof recess near center of vehicle. Remove console and lay it in a safe place. See Figure 1.

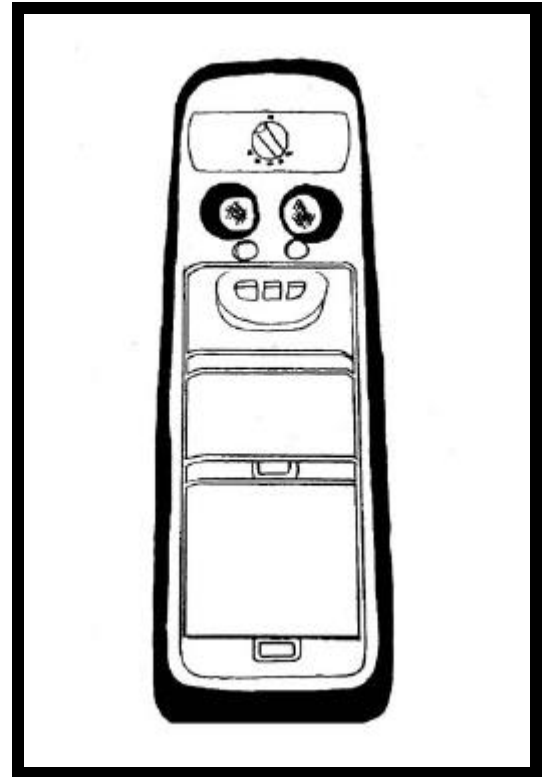

FIGURE 1

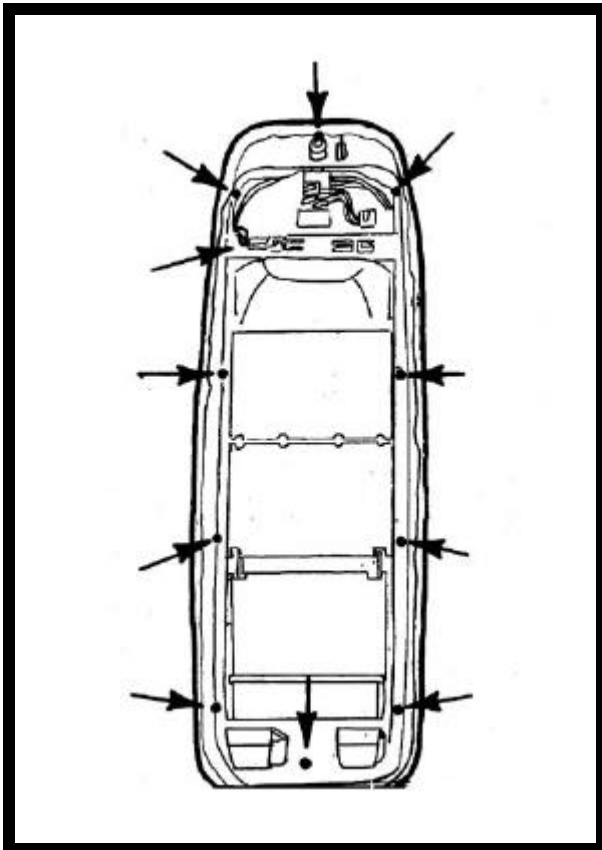
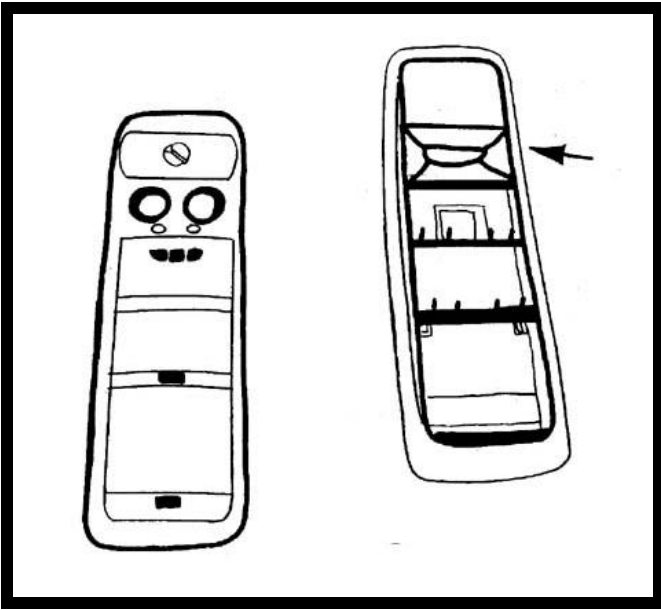

FIGURE 2

2. Turn console over and place on a covered surface. Remove plastic molded assembly from cloth covered trim ring. Using a 7/64" drill bit, drill through the center of the (10) ten plastic pins which secure console together. See Figure 2. **CAUTION: Do not drill deeper than 1/2" or you may drill through console in some areas.** Using a small chisel, carefully remove the head of the (10) ten plastic pins. Unsnap the wiring connector secured to clip on trim ring and separate console from trim ring. See Fig. 2.



**FIGURE 3**

3. Discard trim ring. See Figure 3.

Using a razor knife, carefully trim the (10) ten plastic pins flush with the shoulder. See Figure 4.

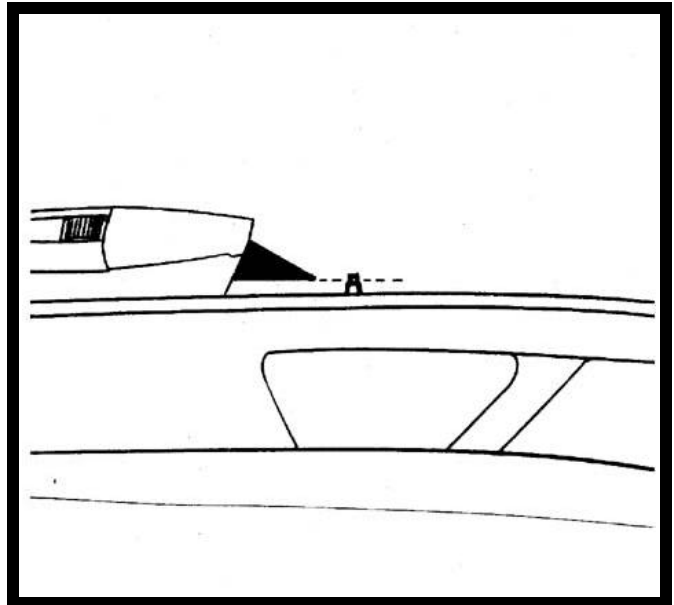

**FIGURE 4**

4. Remove OEM dome light and rear air conditioning control head. Disconnect wiring and set control head aside in a safe place. Remove the OEM ground screw near the center dome light assembly if applicable. See Figure 5.

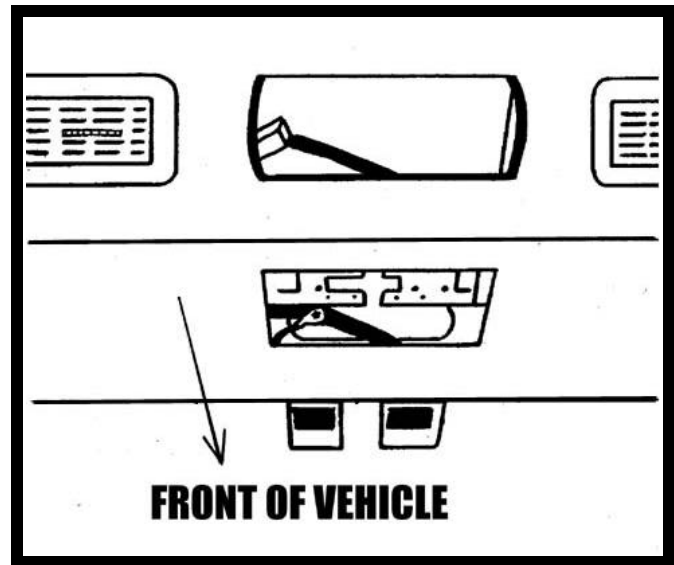

FIGURE 5

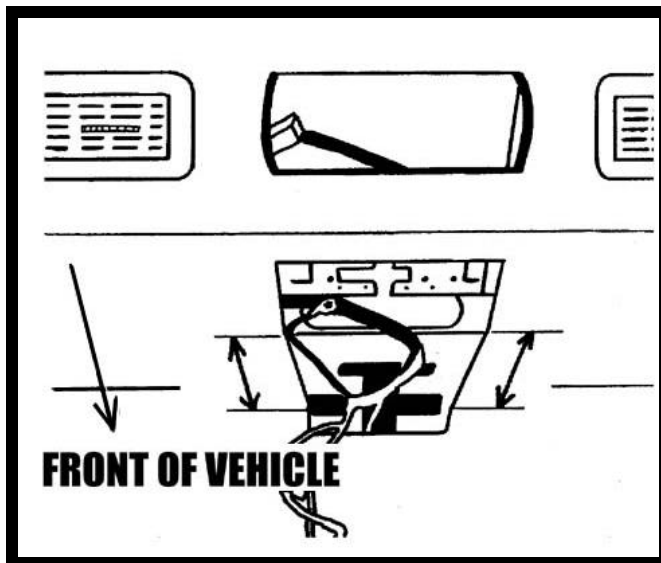

FIGURE 6

5. Cut the headliner material between dome light opening and the front openings for OEM pod retainer arms. **Caution: Before cutting material, check for wiring or other componentry above headliner. Cut only where indicated.** See Figure 6.

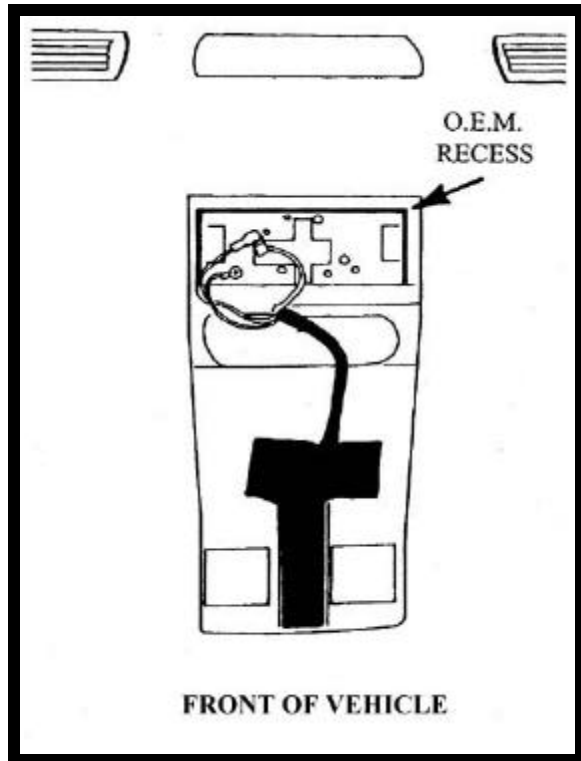

FIGURE 7

6. Install the rear mounting bracket (item 5 pg 2 ) in the O.E.M. dome light area. Align the front mounting tabs with the openings in the metal inner roof openings previously used to support the rear pod retainers. Slide bracket to rear of vehicle until flange contacts rear edge of recessed area. See Figure 7.

7. Secure bracket to sheetmetal frame using four (4) # 8 x 3/4" HWH TEKS screws ( item 1 pg 2 ). Secure O.E.M. ground wire (if applicable) using one of the screws. See Figure 8.

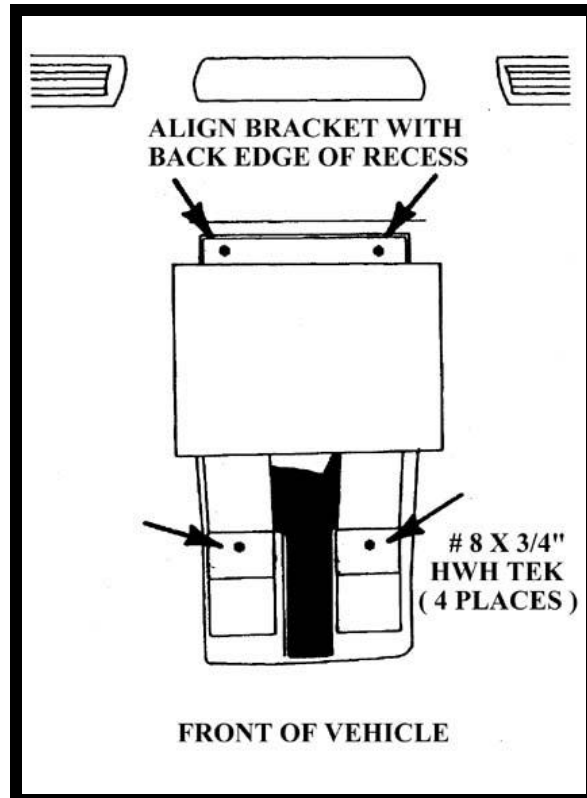
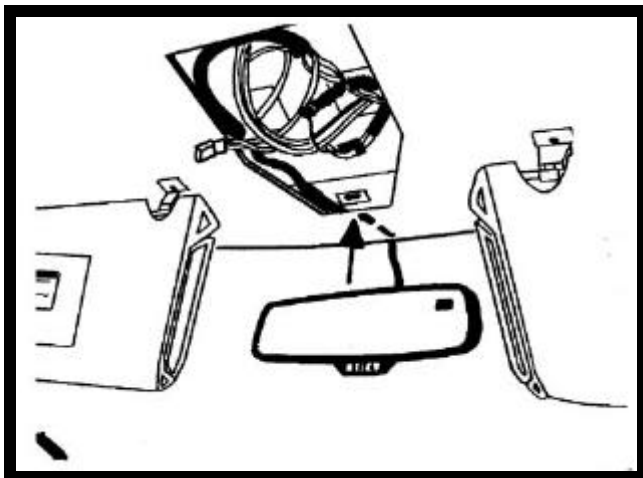

FIGURE 8



**FIGURE 9**

8. If vehicle is equipped with an electronic compass, unsnap the wire harness clip and relocate toward center of vehicle. See Figure 9.

9. Remove and retain the two ( 2 ) door scuff plates on driver's side. See Fig. 10.

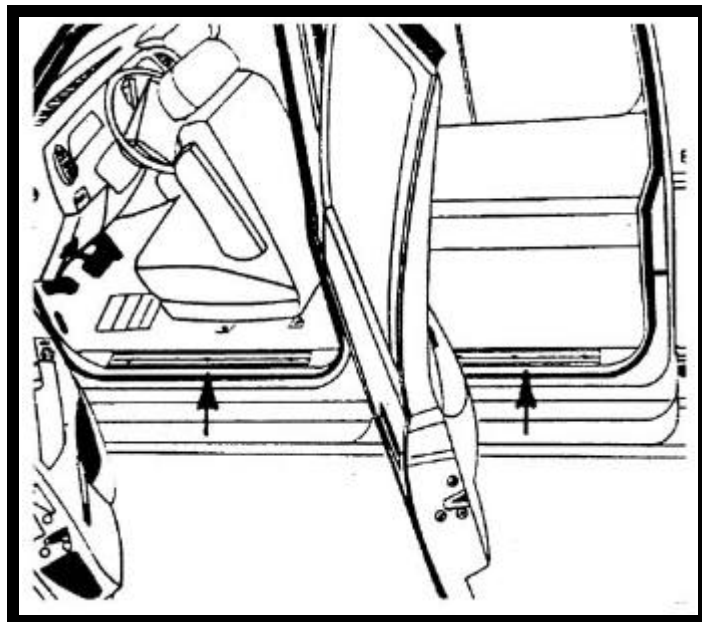

**FIGURE 10**

10. Remove and retain the handle which mounts to top of the "B" pillar.
11. Unsnap the cover from upper and lower mounting bracket for seat belt. Remove and retain TORX head bolt and bracket. Carefully pull panel away from side of vehicle. Unsnap upper door trim from headliner and lay aside. See Figure 11.

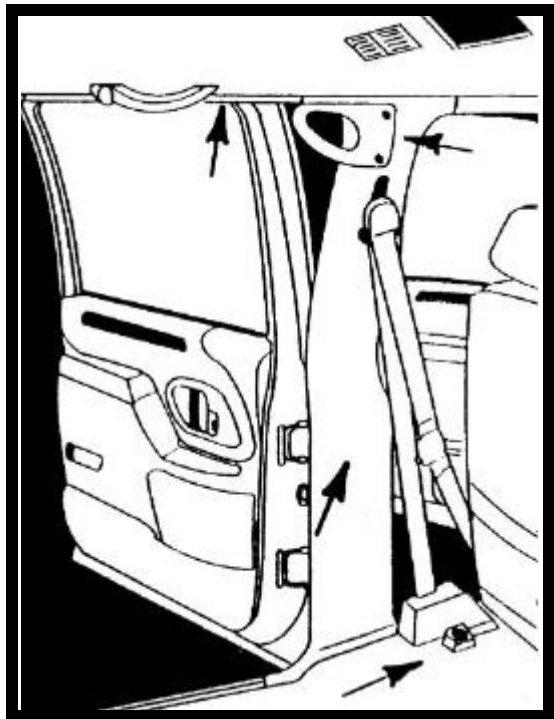
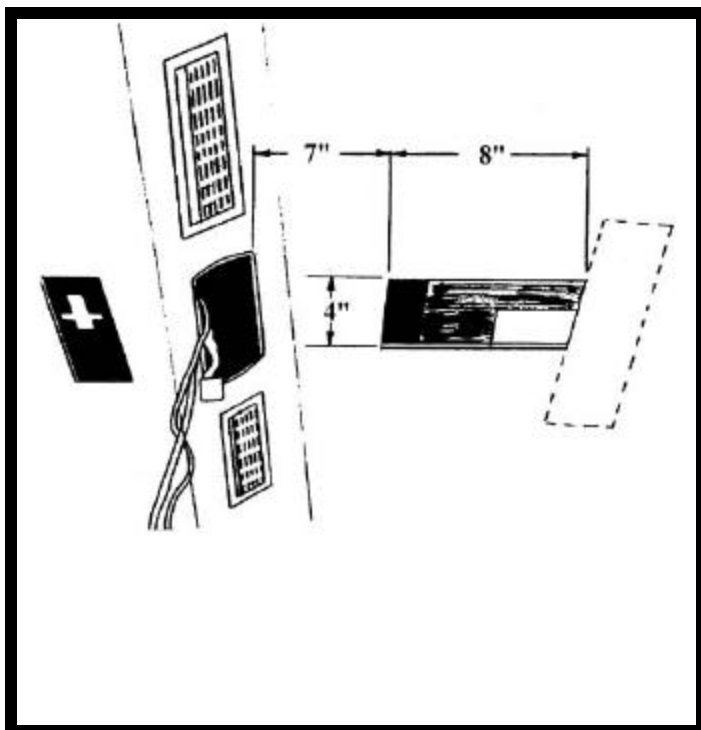

FIGURE 11



12. Measure 7" from rear A/C control opening toward rear of vehicle. Using a razor knife, carefully cut an opening that is 4" wide x 8" long. Make sure that the 4" width is centered in the vehicle. See Figure 12.
13. Insert the 6" x 14" piece of plywood (item 8 pg 2 ) through opening and rotate 90°.

FIGURE 12



14. Route all accessory wiring, video and audio cables, and any other added component requirements to their respective places in the vehicle. Refer to component installation instructions for wiring diagrams. For Suburban applications, the suggested routing of the video system cable is as follows:
- Above headliner from video system to B-pillar.
  - Down the B-pillar to the floor.
  - Route the separate power and ground leads from this point to convenience center located just forward of the emergency brake pedal. Connect red power lead to an accessory controlled source. Ground the black negative lead to the chassis.
  - Route the remaining wiring ( RCA plugs, Mini AMP connector, and Remote Sensor extension ) to the video system is to be used as a television, install the antenna above the headliner per instructions included in the video system.

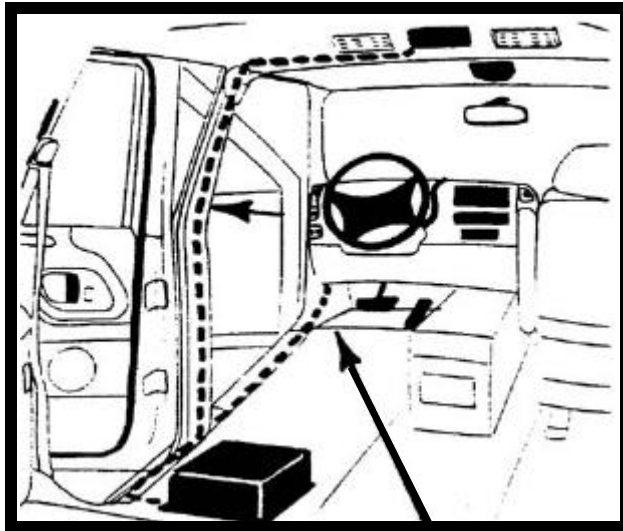
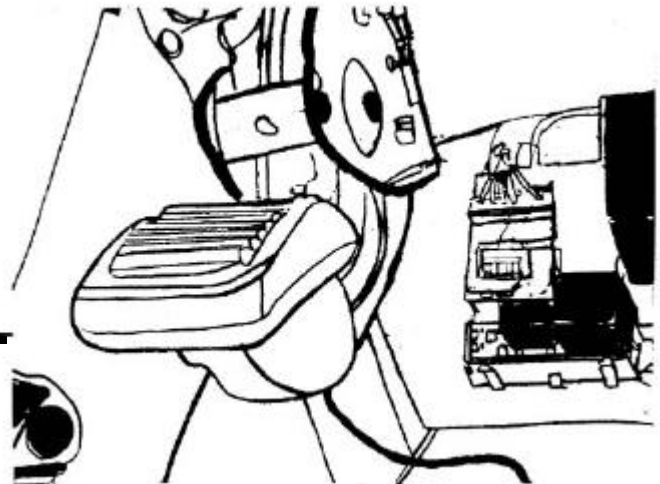

FIGURE 13



15. Re-install the B-pillar cover, upper handle, and door trim. Reattach the seat belt bolt and re-torque to manufacturer's recommended setting. Replace trim pieces previously removed from upper and lower seat belt.

## II. PREPARATION OF CONSOLE FOR INSTALLATION

1. Position the O.E.M. console in the front recess area of the new console (item 4 pg 2 ). Carefully fit the two together, aligning the rear compartment hinge arms through the slots in the recess pocket area. See figure 14.

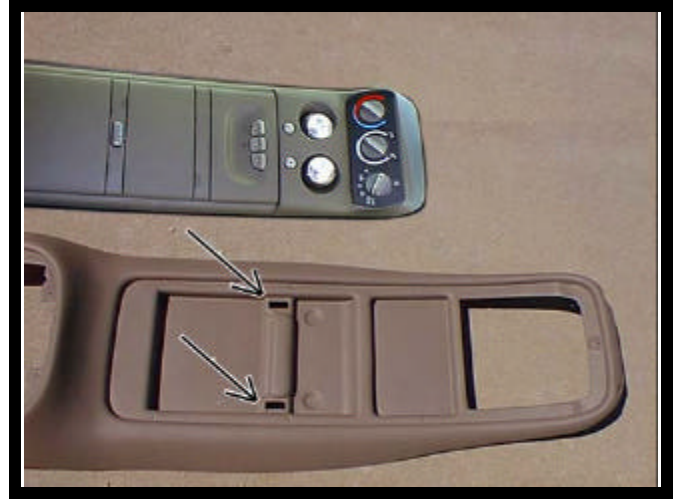

FIGURE 14

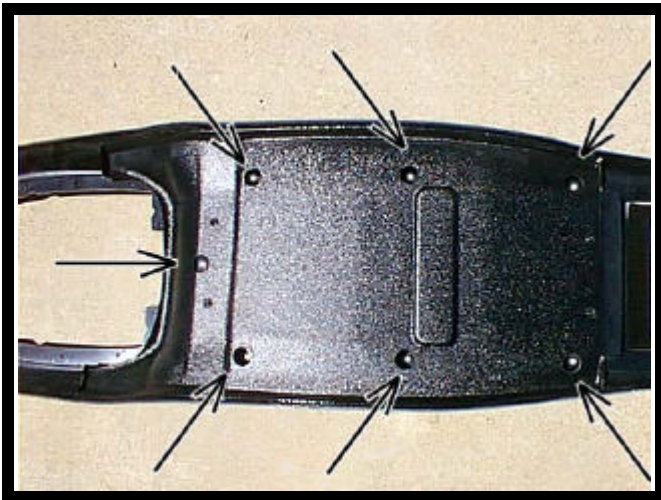
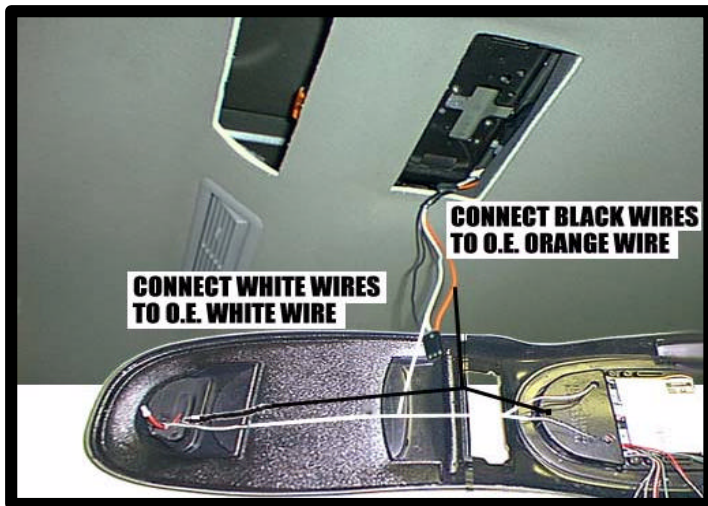

FIGURE 15

2. Secure the O.E.M. compartment assembly into the console recess using (10) ten # 6 X 1/2" screws ( item 9 pg 2 ). Start all screws before tightening beginning with the front center, rear center, then alternately on each side. See figure 15. **Caution: Do not overtighten screws.**

## IV. INSTALLATION OF OVERHEAD CONSOLE.

**Caution: Do not overtighten screws. Use extra support for the console until secured to the vehicle. Failure to do so may cause damage to console or installed components.**



**Figure 16**

2. Raise overhead console into approximate position and connect wiring to O.E. components.
3. Loosely fit console against headliner. Check that console is centered in vehicle and matches all contours of headliner. While supporting console in mounting position, loosely install using two (2) 6-32 X 3/4" screws (item 10 pg 2) through the smaller holes in bracket on console into threaded clips on mounting bracket. See Figure 17.

1. Construct a jumper harness that will connect the vehicle's dome light wires to the lights in the console and video system. Connect the white wires from lights to the O.E. white wire. Connect the black wires from lights to the O.E. orange wires. Do not use O.E. black wire. See Figure 16.

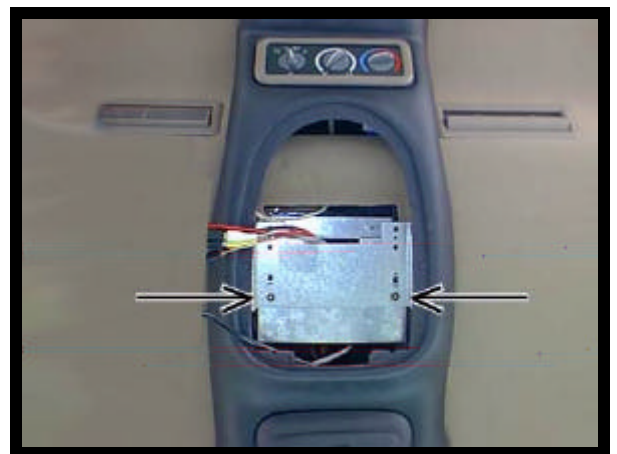

**Figure 17**

4. Secure front of console using two (2) # 8 X 1 1/4" PWH screws (item 3 pg 2) in front of console. See Figure 17. **Caution: Do not overtighten screws or damage to vehicle roof may occur.**
5. Open sunglass holder on O.E. console. Install two (2) # 8 x 1 1/4" PWH screws (item 3 pg 2) in dimple area. See Figure. 17. **Caution: Do not overtighten screws or damage to vehicle roof may occur.**
6. Tighten 6-32 X 3/4" screws previously installed in step 3.



**Figure 18**

7. Release video screen from locked position. Lower video screen to viewing position for access to mounting locations in top of video system housing.
8. Raise video system into approximate position and connect all wiring to components. Route video cable through hole in mounting bracket. Connect wiring and cabling to video system per instructions included with video system.
9. Check function of all components and lights. See operating instructions for video system operations check. For further assistance, refer to the video system manual for the technical support phone number listed for your area.

10. Insert video system into opening in console.  
**Note: Make sure that wires do not get pinched between bosses on video system and console.** Align holes in housing with threaded clips in mounting bracket. Loosely install four (4) 6-32 X 3/4" screws (item 10 pg 2) and four (4) 3.5 mm washers (item 11 pg 2). **Caution: Do not overtighten screws.** See Figure 19.
11. Raise video screen into locked position.



**Figure 19**

12. Attach wiring to rear light (item 6 pg 2) per step 1. Install light in console and secure to plywood above headliner using three (3) # 8 x 2 1/2" PFH screws (item 2 pg 2). See Fig. 20. Tighten screws until rear edge of console contacts headliner. **Caution: Do not overtighten screws or damage to vehicle roof may occur.**

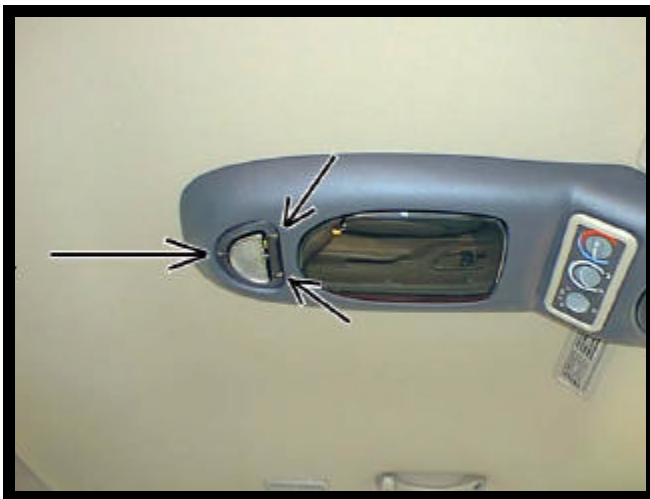

**Figure 20**

13. Install trim ring (item 7 pg 2) around light.
14. Attach O.E. wiring to rear A/C control head. Carefully snap O.E. trim ring around control head. Insert control head into opening and press firmly to engage tabs.

15. Check function of all components and lights. If O.E. console was equipped with a Homelink™ transmitter, refer to the vehicle owner's manual for reprogramming instructions.

## Free Manuals Download Website

<http://myh66.com>

<http://usermanuals.us>

<http://www.somanuals.com>

<http://www.4manuals.cc>

<http://www.manual-lib.com>

<http://www.404manual.com>

<http://www.luxmanual.com>

<http://aubethermostatmanual.com>

Golf course search by state

<http://golfingnear.com>

Email search by domain

<http://emailbydomain.com>

Auto manuals search

<http://auto.somanuals.com>

TV manuals search

<http://tv.somanuals.com>