

**PROV710 /
PROV710 S /
PROV 710 P
DROP-DOWN VIDEO
MONITOR WITH BUILT-IN
DVD PLAYER**

Mobile
VIDEO

**Operation
Manual**

128-6743



Date: 12/05/2003

Date: 21/5/2003-PROV710 S & PROV710 P ADDED

128-6743

1 of 26

IMPORTANT

An LCD panel and/or video monitor may be installed in a motor vehicle and visible to the driver if the LCD panel or video monitor is used for vehicle information, system control, rear or side observation or navigation. If the LCD panel or video monitor is used for television reception, video or DVD play, the LCD panel or video monitor must be installed so that these features will only function when the vehicle is in 'park' or when the vehicle's parking brake is applied.

An LCD panel or video monitor used for television reception, video or DVD play that operates when the vehicle is in gear or when the parking brake is not applied, must be installed to the rear of the driver's seat where it will not be visible, directly or indirectly, to the operator of the motor vehicle.

Warnings

Do not use any solvents or cleaning materials when cleaning the video monitor.

Do not use any abrasive cleaners, they may scratch the screen. Use only a lightly dampened lint free cloth to wipe the screen if it is dirty.

Lock the LCD screen in the fully closed position when not in use.

Before putting on headphones always adjust the volume setting to the lowest position.

Remember to leave the dome light switch in the off or auto positions when the vehicle is unattended, as the dome lights, if left on, can drain the vehicle's battery.

Do not put pressure on the screen.

Caution children to avoid touching or scratching the screen, as it may become dirty or damaged.

Congratulations on your purchase of the Audiovox PROV710/PROV710 S /PROV710 P DVD Player with Drop-Down Video Monitor. The PROV710/PROV710 S /PROV710 P has been designed to give you and your family many years of video entertainment in the mobile environment. Please read the directions that follow to familiarize yourself with the product and to ensure that you obtain the best results from your equipment.

Please note: Installation options vary, see the individual owner's manuals for each component in your system to obtain a full understanding of each component's operation.

Safety Precaution

For safety reasons, when changing video media it is recommended that the vehicle is not in motion, and that you do not allow children to unfasten seat-belts to change video media or make any adjustments to the system. System adjustments can be accomplished using the remote control unit, while seat-belts remain fastened. Enjoy your Audiovox entertainment system but remember-safety of all passengers remains the number one priority.

Features

- **7 Inch TFT (Thin Film Transistor) Active Matrix LCD (Liquid Crystal Display) Monitor**
- **OSD (On Screen Display) for Control of Picture Quality and Functions**
- **Full Function Remote Control**
- **Infrared Transmitter for IR Wireless Headphones**
- **One Audio / Video Input**
- **Dome Lights with Switch**
- **Backlit Controls for Low Light Operation**

Controls and Indicators Diagram

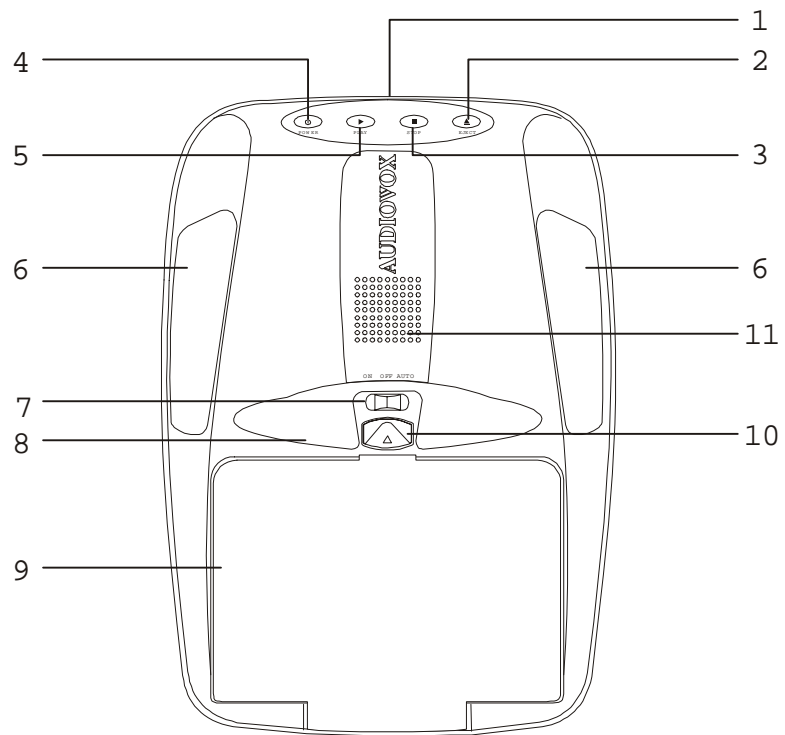

Closed Position

13

Open Position

Main Function Descriptions

1. **DVD disc insertion slot.**
2. **Eject (▲) Button** – Ejects disc.
3. **Stop (■) Button** – Pressing this button will stop playback.
4. **Power Button** – Bright red when system is on, dim when off.
5. **Play (▶) Button** – This button is used to enter the play mode.
6. **Dome Lights** – provide additional interior illumination.
7. **Three position Dome Light Switch**
 - Auto – Automatically switches on the dome lights in conjunction with the vehicle's interior illumination.
 - Off – The dome lights will not turn on in this position.
 - On – Turns on the dome lights.
8. **Infrared Transmitter and Sensor** – Use to transmit audio to wireless headphones. Also allows the remote control to operate the PROV710/PROV710 S /PROV710 P OSD (On Screen Display) and to control other accessories in the system.
9. **Drop Down LCD Panel.**
10. **Screen Release** – Moves in direction of the arrow to release the drop down screen.
11. **PROV710/PROV710 S /PROV710 P Ventilation Opening.**
12. **Source Select Button** - Allows the user to select the source: DVD and AV1.
13. **LCD Panel Shut-Off Switch**

Remote Control Operation

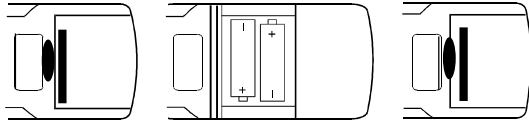

Battery Installation

Before attempting to operate your Remote Control, install the batteries as described below.

- 1) Turn the Remote Control face down. Using a fingernail, lift the battery cover off.
- 2) Install two "AAA" batteries as shown. Make sure that proper polarity (+ or -) is observed.
- 3) Align the cover tabs with the remote control and press down until the cover clicks.

The remote control will operate the PROV710/PROV710 S/PROV710 P. It is not a universal remote control and will not control equipment from other manufacturers

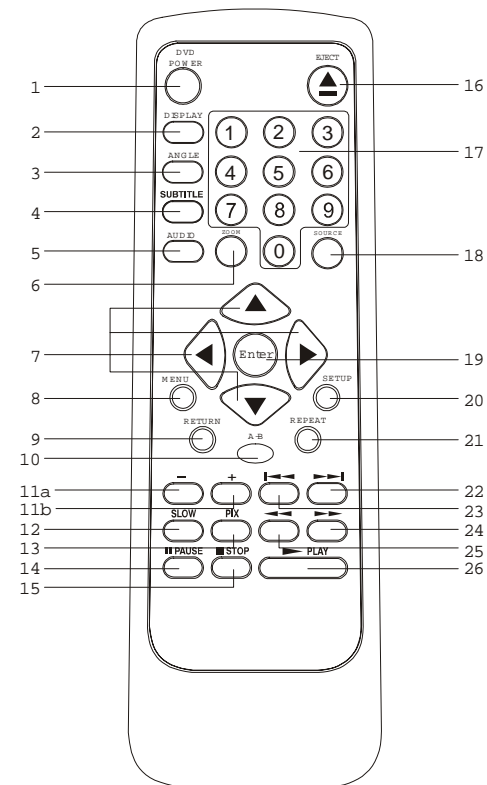

DVD Function Descriptions

*Function control is available on the unit and the remote control.

1. DVD POWER ON/OFF Button*

Press this button to turn the PROV710/PROV710 S /PROV710 P on.
Press the button again to turn the PROV710/PROV710 S /PROV710 P off.

2. DISPLAY Button

Press to display DVD Disc current information.

Press DISPLAY button	DVD Player Perform
Once	TITLE Elapsed Time
Twice	TITLE Remain Time
3 times	CHAPTER Elapsed Time
4 times	CHAPTER Remain Time
5 times	Display is turned off

3. ANGLE Button

Press to display & select the camera angles. Each time you press the button, the angle changes.

Note: The number of angles vary from disc to disc. Not all disc's contain this option

4. SUBTITLE Button

Press to display & select the subtitle language in DVD. Each time you press the button, the subtitle language changes.

Note: The type & number of languages for subtitles vary from disc to disc.

5. AUDIO Button

5. AUDIO Button

Press to display & select AUDIO language & channel. Each time you press the button, the language or channel changes.

Note: The languages & channel you can select are vary from disc to disc.

6. ZOOM Button

Press this button to zoom the picture.

Press ZOOM button	OSD	DVD Player Perform
Once	ZOOM x2	ZOOM picture 2 times
Twice	ZOOM x3	ZOOM picture 3 times
3 times	ZOOM x4	ZOOM picture 4 times
4 times	ZOOM x1/2	Reduce picture to 1/2
5 times	ZOOM x1/3	Reduce picture to 1/3
6 times	ZOOM x1/4	Reduce picture to 1/4
7 times	ZOOM OFF	Normal display

7. CURSOR Button (▲▼◀▶)

Use these buttons to do items selection.

8. MENU Button

Allows the user to access main menu.

9. RETURN Button

Press to return to the main page.

10. A-B REPEAT Button

Allows the user to repeat play of a DVD or CD from point A to point B.

11a. Select Down (-) Button

Used this button to make picture adjustments in picture select mode.

b. Select Up (+) Button

Used this button to make picture adjustments in picture select mode.

Description of Adjustment Items:-

<i>Item</i>	<i>Press Select Down(-) button</i>	<i>Press Select Up(+) button</i>
CONTRAST	Decrease the contrast for soft color	Increase picture contrast for vivid color
BRIGHTNESS	To darken the picture	To brighten the picture
TINT	Increases the greenish skin tones	Increases the redish skin tones
COLOR	To decrease the color intensity	To Increase the color intensity

12. SLOW Button

The DVD viewing speed will be reduced at 1/2, 1/4, 1/8 and 1/16 times the normal speed.

13. PIX Button (PICTURE SELECT)

Each time this button is pressed, the on screen picture adjustment display the “adjustment bars” for CONTRAST/ BRIGHTNESS, COLOR or TINT. Once the desired adjustment bar is displayed, use the Select up/Select Down buttons to adjust the setting. The display will automatically turn off if no adjustments are made within 6 seconds, or if any other button is depressed.

14. PAUSE (II) Button

DVD disc play will be paused.

15. STOP (■) Button *

DVD disc play will be stopped.

16. EJECT(▲) Button *

The disc will be ejected disc from disc compartment.

17. NUMBERS Buttons

Allows the user to enter the numbers 0 to 9 for selection of CD tracks, DVD chapters, and password setting.

18. SOURCE Button*

Video signals from video equipment connected to the audio / video input can be displayed on the monitor by pressing this button. Each time the button is pressed, the audio / video source will change in the following sequence: DVD and AV1.

19. ENTER Button

Used to implement setting selected.

20. SETUP Button

Allows the user to select the DVD player's options (Display, OSD Language, Defaults, Parental Control, Password, Exit Setup)

21. REPEAT Button

Allows the user to repeat various positions of a DVD, CD or MP3.

22. NEXT (▶▶|) Button

Allows the user to skip to the next chapter or track.

23. PREVIOUS (|◀◀) Button

Allows the user to return to the previous chapter or track.

24. Scan Forward (▶▶) Button

Allows the user to search in a forward direction at 2,4, 6, 8, 16 and 32 times the normal speed.

25. Scan Backward (◀◀) Button

Allows the user to search in a backward direction at 2,4, 6, 8 and 32 times the normal speed.

26. PLAY (▶)Button*

Press this button to activate the play mode while a disc is loaded into the disc compartment.

Turning the PROV710/PROV710 S /PROV710 P On or Off

1. Sliding the screen release lock forward will unlock the LCD screen and it will drop down slightly. Pivot the screen downward until a comfortable viewing angle is reached. The internal friction will hold the screen in position while the system is in use.
2. Pressing the power button on the unit or the remote control will turn the system on or off alternately. When in use the internal backlighting will illuminate the controls.
3. After the unit has been turned on and is displaying a picture, adjust the viewing angle, by pivoting the screen to optimize the picture quality.
4. Remember to turn the unit off and pivot the LCD Panel to the locked position when not in use.

Overhead Dome Lights

The lights integrated into the PROV710/PROV710 S / PROV710 P are controlled by a three position slide switch. Sliding the switch to the on position will turn the lights on. The off position will prevent the lights from turning on at all times, and the auto position will allow the lights to turn on and off with the vehicle's interior lighting. Refer to the Installation Manual for the wire connections. Do not leave the vehicle unattended with the dome light switch in the on position, as this could result in a discharged battery.

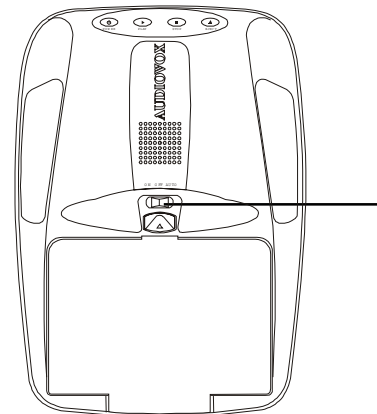

Dome
Light
Switch

Remote Sensor

The PROV710/PROV710 S /PROV710 P incorporates an infrared sensor, which will relay signals from the remote control to allow the unit to be controlled simply by pointing its remote control at the remote sensor eye. The repeater function allows control of auxiliary equipment such as an Audiovox Video Cassette Player. The infrared sensor can relay signals from most manufacturer's remote controls to its respective component connected to the Video input. In this case you must use the remote control supplied with the component.

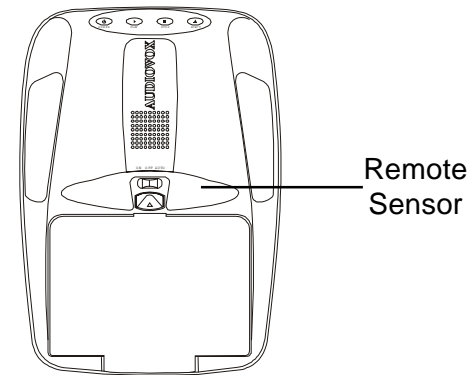

Accessories

Wireless Headphones

The PROV710/PROV710 S /PROV710 P includes a built-in infrared transmitter for use with Audiovox wireless headphones (Part Number MVIRHS). The volume can then be adjusted using the controls on each headset. The wireless headphones must be used within a line of sight from the transmitter, as infrared transmissions, like visible light travel only in a straight line. See the documentation accompanying your Audiovox wireless headphones.

Headset Special Features

- Automatic Level Control prevents input signal over loading.
- Uses high frequency infrared light to assure a clean signal for clear reception.

AV1

This video input may be connected to a Video cassette Player (VCP), video game system, or other audio / video device. To access the A/V input, turn the PROV710/PROV710 S /PROV710 P on and press the source select button on the PROV710/PROV710 S /PROV710 P or the Source button on the remote control until "AV1" is displayed on the screen. Turn the video source component on with its power button or remote control. The PROV710/PROV710 S /PROV710 P is now ready to play the audio and video signals from the source connected to the AV1 input.

Video Out

The PROV710/PROV710 S /PROV710 P provides a video output for an optional video monitor(s). (Refer to page 6 of the Installation Guide for more details.) This output will provide a video signal that duplicates the signal displayed by the PROV710/PROV710 S /PROV710 P to an additional monitor or video display. Please see your installer for more information.

DVD Basics

To get the optimum use out of the DVD section, make sure you read this section completely.

Regional Coding

Both the DVD player and disc are coded by region. These regional codes must match in order for the disc to play. If the codes don't match, the disc won't play. This unit's code is region 1. Other regional codes cannot be played in this unit. The unit will display "WRONG REGION."

Types of Discs your DVD will play

- DVD discs – DVDs discs which contain video.
- Audio discs – Audio CDs contain musical or sound content only.
- MP3 discs – A disc that contains audio files (for example, a CD-R with downloaded MP3 files).

Loading and Playing Discs

Before you load a disc, make sure that it is compatible with the player.

Note: the following Discs CANNOT be used with this player :

- *MiniDisc*
- *Laserdisc*
- *CD-I, CD-ROM, DVD-ROM*

To load and Play a Disc

When you press the Power button the unit will turn on and display the source selected. Select DVD mode and insert the disc (Label Up) into the disc compartment. When the disc is half way in it will be automatically pulled in and play will begin.

Settings and Adjustments

This chapter describes how to set and how to adjust using the on-screen SETUP menu.

Using the Setup Menu

Using the setup menu you can do the initial setup and set the various options. You can also select a language for the on-screen display, the setup display, and limit play back by children.

- 1) Press the SETUP button to display the “setup menu” on the TV screen.
- 2) Select the main item you want using the cursor (▲▼) buttons, and then press the ENTER button.

To Cancel Using the Setup Display

Press the SETUP button on the remote.

Setting the Language for On-Screen Display

Press the SETUP button and using the (▲▼) buttons select “OSD LANGUAGE”.

OSD (On-Screen Display) Language Menu

The OSD Language Menu allows the user to select the language for the on-screen display. Press ► and then use the (▲▼) buttons to select the desired language. The user can select either English, French or Spanish for the OSD language.

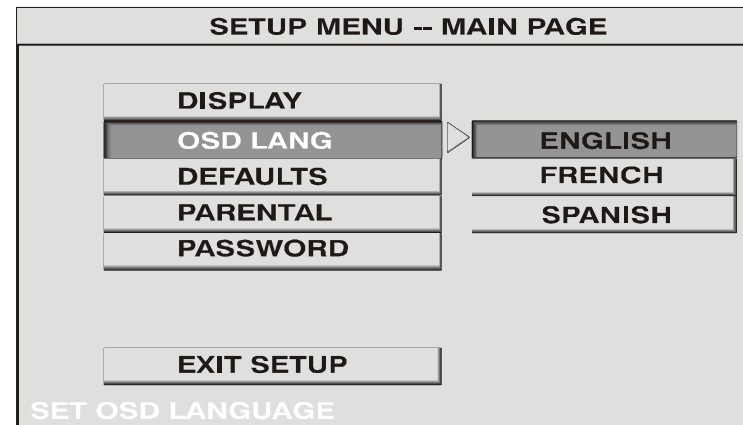

Settings for Display

Press the SETUP button and select Display. The DISPLAY SETUP allows you to adjust screen setting (aspect ratio) Press ► and then use the (▲▼) buttons to select the appropriate settings.

4:3 / PS

This displays the wide picture on the screen with a portion of the left & right side removed.

4:3 / LB

This displays the wide picture with black bands on the upper and lower portions of the screen.

16:9

This displays a picture with black bands on the upper and lower portion of the screen.

Then press ENTER to confirm your selection.

Defaults Settings

Press the SETUP button and select Defaults. The DEFAULTS SETUP allows you to reset ALL options to the factory default Settings. Press ► and then press Enter to implement the reset function.

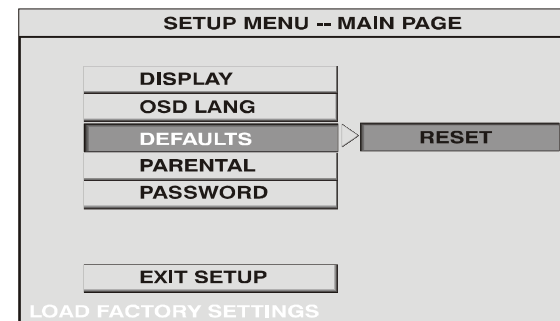
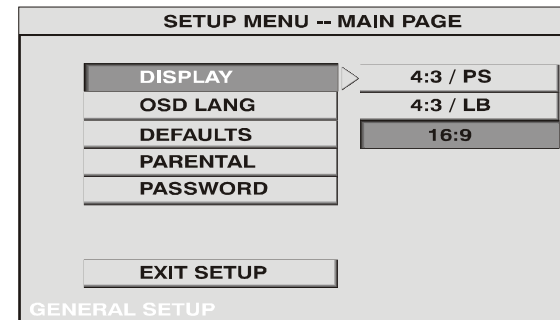

Settings for Parental (Parental Control)

This section of the SETUP Menu allows user to control the content of movie playback from G to NO_PARENTAL. The Parental Control function allows you to limit viewing to your preference.

1. Use the ▲▼ buttons to select
G (Children)
PG
PG 13
R
NC-17
ADULT (Adult)
NO_PARENTAL (No Parental Control)

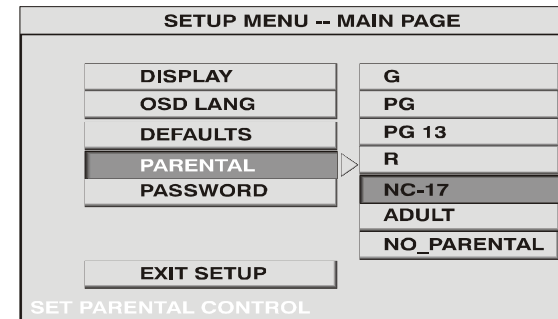

Note: *The lower the value, the more strict the limitation.*

Press the Enter button to confirm the selection.

2. Input a password in 4 digits using the numeric buttons then press the Enter button.
The Default password is 3308.

Settings for Password (Parental Control Password)

Press the SETUP button and select PASSWORD. The PASSWORD SETUP allows you to change the parental control password. Press ► and then press Enter.

OLD PASSWORD

Input the OLD password or the default password (4 digits) using the numeric buttons

NEW PASSWORD

Input a NEW password (4 digits)

CONFIRM PWD

Confirm the new password by entering the same new password again.

Then press Enter to implement it.

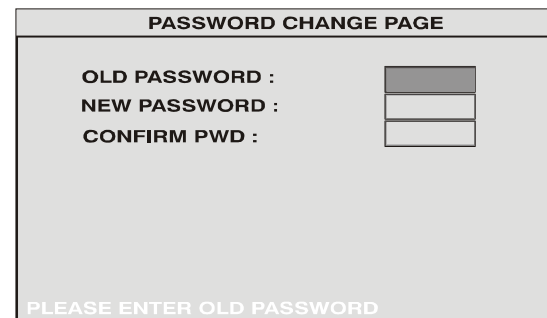
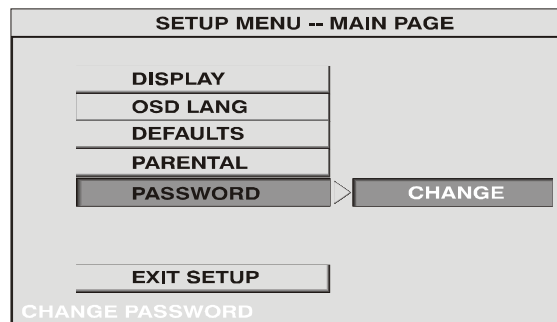

Playing Audio CDs

When playing an audio CD, the DISPLAY Banner appears automatically. It displays the current track, the total amount of tracks, and the amount of the time for the track playing. Press the DISPLAY button on the remote to change the DISPLAY Banner. The options below show you what happens when you press the DISPLAY button.

SINGLE REMAIN appears along with the current track playing and the amount of time left.



TOTAL ELAPSED appears along with the current track playing and the total time playing on the CD.

TOTAL REMAIN appears along with the current track playing and the amount of time left on the CD.

SINGLE ELAPSED appears along with the current track playing and the time of that track.

Using the REPEAT Feature

The default mode for the Repeat feature is OFF. Pressing REPEAT consecutively changes the repeat options:

-  *TRACK*- repeats the track that is playing.
-  *ALL*- repeats the disc that is playing.
- *REPEAT OFF*

Playing MP3 Discs

MP3 is a format for storing digital audio. An audio CD-quality song can be compressed into the MP3 format with very little loss of quality, while taking up much less space. CD-R discs that have been encoded in MP3 format can be played on your DVD player.

Press the DISPLAY button on the remote to DISPLAY Banner. The options below show you what happens when you press the DISPLAY button.

SINGLE ELAPSED appears along with the amount of time the song has played. *SINGLE ELAPSED* and the time will remain on-screen until you press DISPLAY again.

SINGLE REMAIN appears along with the amount of time left in the song that is playing. *SINGLE REMAIN* and the time that is left remain on-screen until you press DISPLAY again.

DISPLAY OFF appears and will turn off the display of the amount of the time the song has played.

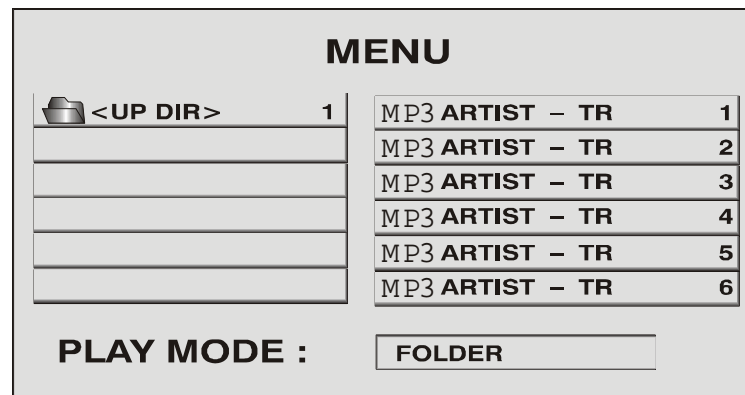

Selecting Folders and Songs

When an MP3 disc is inserted in the player, the screen appears automatically. You can change folders and songs through the menu. The DVD player plays the songs in order they were burned on to the disc.

1. Press the up or down arrow button to go through the folder list on the left side of the screen.
2. Once the folder you want is highlighted, press Enter and the songs in the folder appear on the right.
3. Press the up or down arrow button to go through the song list and highlighted the song you want. Press Enter or PLAY button to begin playback of the highlighted song.

Skipping Songs

Use the Next (▶▶) button on the remote control to move to the next song. Use the Previous (◀◀) button to move to the beginning of the currently playing song. Press the (◀◀) button again to move to the previous song.

Using The Repeat Feature

The default mode for the Repeat feature is OFF. Pressing REPEAT consecutively changes the repeat options:

- *REPEAT ONE*- repeats the songs that is playing.
- *REPEAT FOLDER*- repeats the folder that is playing.
- *FOLDER*- turns off repeat and returns to regular play mode.

Selecting a Play Mode

You can choose what order the songs will play on a disc temporarily. The FOLDER play mode is the default. To access the play mode options, press STOP if the disc is playing. Press the right arrow button until the PLAY MODE option is highlighted. Use the up or down arrow to choose a option. The play mode options are:

- *SINGLE*: Play a selected song.
- *SHUFFLE* : Plays the songs in random order (from within the selected folder)

Troubleshooting

PROBLEM	SOLUTION
Poor in vehicle radio reception (FM modulator installed)	<ul style="list-style-type: none"> • Check the condition of the vehicle's radio antenna. • Verify that the antenna is fully raised. • If a wired RF modulator has been installed, verify that it is turned OFF.
IR sensor inoperative	<ul style="list-style-type: none"> • Verify that the batteries in the remote are fresh. • Verify that the remote sensor eye is not obstructed. • Verify that the infrared transmitter is affixed over the sensor eye of the component to be controlled.
Disc won't play	<ul style="list-style-type: none"> • Insert a disc with the label side facing up. • Check the type of disc you put into disc tray. This DVD only plays digital video discs, audio CDs and MP3s. • Both the unit and the disc are coded by region. If the regional codes don't match, the disc can't be played. This DVD Player is Region Number 1.
Play starts, but then stops immediately	<ul style="list-style-type: none"> • The disc is dirty. Clean it. • Condensation has formed. Allow player to dry out.

PROBLEM	SOLUTION
No sound or distorted sound	<ul style="list-style-type: none"> • Make sure your DVD is connected properly. Make sure all cables are securely inserted into the appropriate jacks. • If you are using the IR headphones, make sure you turn on the IR power. • Make sure Modulator is ON and the proper Frequency has been selected.
Can't advance through a movie	<ul style="list-style-type: none"> • You can't advance through the opening credits and warning information that appears at the beginning of movies because the disc is programmed to prohibit that action.
The icon (⊘) appears on screen	<p>The feature or action cannot be completed at this time because:</p> <ol style="list-style-type: none"> 1. The disc's software restricts it. 2. The disc's software doesn't support the feature (e.g., angles) 3. The feature is not available at the moment. 4. You've requested a title or chapter number that is out of range.

PROBLEM	SOLUTION
Picture is distorted	<ul style="list-style-type: none">• The disc might be damaged. Try another disc.• It is normal for some distortion to appear during forward or reverse scan.
No forward or reverse scan	<ul style="list-style-type: none">• Some discs have sections that prohibit rapid scanning or title and chapter skip.• If you try to skip through the warning information and credits at the beginning of a movie, you won't be able to. This part of the movie is often programmed to prohibit skipping through it.

Replacement Parts		Specifications	
Remote Control	136B3469	LCD Backlighting	Edge Light Tube
		Resolution	1440 x 234
		Pixels	336,960
		Operation Temperature	32 -140° F (0 - 60° C)
		Storage Temperature	-4 - 176° F (20 - 80° C)
		Backlight life	10,000 Hours
		Video Display System	NTSC/PAL
		Low Level Audio Output	620 mvp-p
			1 kHz @ -15 dB
		Video Output	1.0Vp-p @ 75 ohms
		Power Source	12V DC



36 MONTH LIMITED WARRANTY

Applies to Audiovox Mobile Video Products

AUDIOVOX ELECTRONICS CORP. (the Company) warrants to the original retail purchaser of this product that should this product or any part thereof, under normal use and conditions, be proven defective in material or workmanship within 36 months from the date of original purchase, such defect(s) will be repaired or replaced with reconditioned product (at the Company's option) without charge for parts and repair labor.

To obtain repair or replacement within the terms of this Warranty, the product is to be delivered with proof of warranty coverage (e.g. dated bill of sale), specification of defect(s), transportation prepaid, to the Company at the address shown below.

This Warranty does not extend to the elimination of externally generated static or noise, to correction of antenna problems, to costs incurred for installation, removal or reinstallation of the product, or to damage to tapes, discs, speakers, accessories, or vehicle electrical systems.

This Warranty does not apply to any product or part thereof which, in the opinion of the Company, has suffered or been damaged through alteration, improper installation, mishandling, misuse, neglect, accident, or by removal or defacement of the factory serial number/bar code label(s). THE EXTENT OF THE COMPANY'S LIABILITY UNDER THIS WARRANTY IS LIMITED TO THE REPAIR OR REPLACEMENT PROVIDED ABOVE AND, IN NO EVENT, SHALL THE COMPANY'S LIABILITY EXCEED THE PURCHASE PRICE PAID BY PURCHASER FOR THE PRODUCT.

This Warranty is in lieu of all other express warranties or liabilities. ANY IMPLIED WARRANTIES, INCLUDING ANY IMPLIED WARRANTY OF MERCHANTABILITY, SHALL BE LIMITED TO THE DURATION OF THIS WRITTEN WARRANTY. ANY ACTION FOR BREACH OF ANY WARRANTY HEREUNDER INCLUDING ANY IMPLIED WARRANTY OF MERCHANTABILITY MUST BE BROUGHT WITHIN A PERIOD OF 48 MONTHS FROM DATE OF ORIGINAL PURCHASE. IN NO CASE SHALL THE COMPANY BE LIABLE FOR ANY CONSEQUENTIAL OR INCIDENTAL DAMAGES FOR BREACH OF THIS OR ANY OTHER WARRANTY, EXPRESS OR IMPLIED, WHATSOEVER. No person or representative is authorized to assume for the Company any liability other than expressed herein in connection with the sale of this product.

Some states do not allow limitations on how long an implied warranty lasts or the exclusion or limitation of incidental or consequential damage so the above limitations or exclusions may not apply to you. This Warranty gives you specific legal rights and you may also have other rights which vary from state to state.

U.S.A. : AUDIOVOX ELECTRONICS CORPORATION, 150 MARCUS BLVD., HAUPPAUGE, NEW YORK 11788 1-800-645-4994

CANADA : CALL 1-800-645-4994 FOR LOCATION OF WARRANTY STATION SERVING YOUR AREA

© Copyright 2003 Audiovox Electronics Corp. 150 Marcus Blvd. Hauppauge, NY 11788

128-6743

128-6743
26 of 26

Free Manuals Download Website

<http://myh66.com>

<http://usermanuals.us>

<http://www.somanuals.com>

<http://www.4manuals.cc>

<http://www.manual-lib.com>

<http://www.404manual.com>

<http://www.luxmanual.com>

<http://aubethermostatmanual.com>

Golf course search by state

<http://golfingnear.com>

Email search by domain

<http://emailbydomain.com>

Auto manuals search

<http://auto.somanuals.com>

TV manuals search

<http://tv.somanuals.com>