

**VOD705 DL
VOD705 DLS
VOD705 DLP
DVD PLAYER
WITH
DROP-DOWN
VIDEO MONITOR**



**Operation
Manual**

128-6247B

128-6247B

1 of 24



Released 03-08-02.

Revision A: Incorporated LCD switch 03-22-02.

Revision B: Add DLS and DLP models 6-04-02.

Important Notice

It is unlawful in most jurisdictions for a person to drive a motor vehicle which is equipped with a television viewer or screen that is located in the motor vehicle at any point forward of the back of the driver's seat, or that is visible, directly or indirectly, to the driver while operating the vehicle. In the interest of safety, the VOD705 DL/VOD705 DLS/VOD705 DLP should never be installed where it will be visible, directly or indirectly, by the operator of the motor vehicle.

Warnings

Do not use any solvents or cleaning materials when cleaning the video monitor.

Do not use any abrasive cleaners, they may scratch the screen. Use only a lightly dampened lint free cloth to wipe the screen if it is dirty.

Lock the LCD screen in the fully closed position when not in use. Before putting on headphones always adjust the volume setting to the lowest position.

Remember to leave the dome light switch in the off or auto positions when the vehicle is unattended, as the dome lights, if left on, can drain the vehicle's battery.

Do not put pressure on the screen.

Caution children to avoid touching or scratching the screen, as it may become dirty or damaged.

Congratulations on your purchase of the Audiovox VOD705 DL/VOD705 DLS/VOD705 DLP DVD Player with Drop-Down Video Monitor. The VOD705 DL/VOD705 DLS/VOD705 DLP has been designed to give you and your family many years of video entertainment in the mobile environment. Please read the directions that follow to familiarize yourself with the product and to ensure that you obtain the best results from your equipment.

Please note: Installation options vary, see the individual owner's manuals for each component in your system to obtain a full understanding of each component's operation.

Safety Precaution

For safety reasons, when changing video media it is recommended that the vehicle is not in motion, and that you do not allow children to unfasten seat-belts to change video media or make any adjustments to the system. System adjustments can be accomplished using the remote control unit, while seat-belts remain fastened. Enjoy your Audiovox entertainment system but remember-safety of all passengers remains the number one priority.

Features

- **7 Inch TFT (Thin Film Transistor) Active Matrix LCD(Liquid Crystal Display) Monitor**
- **OSD (On Screen Display) for Control of Picture Quality and Functions**
- **Full Function Remote Control**
- **Three Frequency FM Modulator with remote control and OSD**
- **Infrared Transmitter for IR Wireless Headphones**
- **Three Audio/Video Inputs**
- **Headphone / Speaker Amplifier**
- **Two Headphone Jacks**
- **Forward and Side Remote Sensor**
- **Dome Lights with Switch**
- **Backlit Controls for Low Light Operation**

128-6247B

3 of 24

Controls and Indicators Diagram

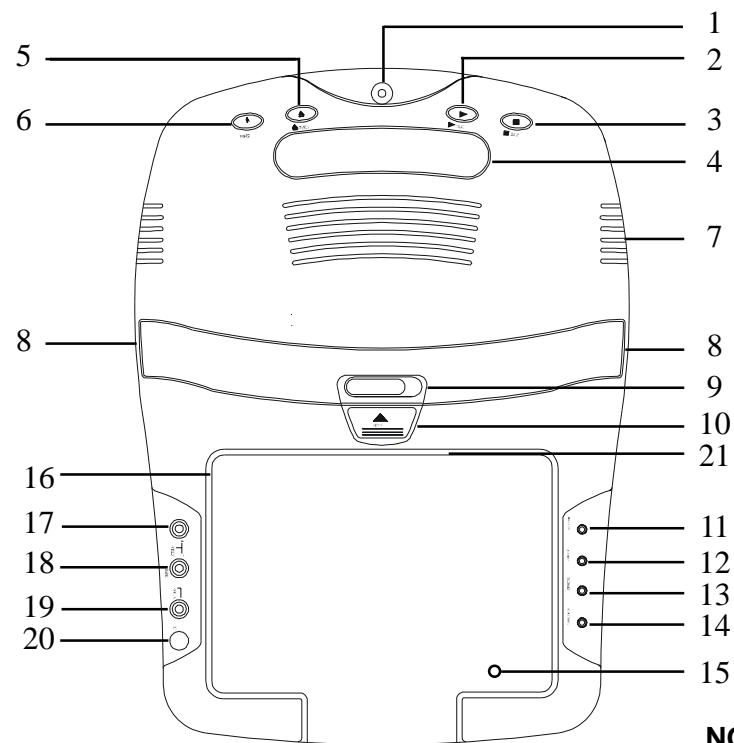

NOTE: LCD Backlight Control Switch located on Inside With the Screen in the Closed Position.

NOTE: Screen Mode Button Located on Inside With the Screen in the Closed Position.

Main Function Descriptions

1. **DVD disc insertion slot.**
2. **Play (▶) Button**
3. **Stop (■) Button.**
4. **Infrared Transmitter and Sensor** – Use to transmit audio to wireless headphones. Also allows the remote control to operate the VOD705 DL/VOD705 DLS/VOD705 DLP OSD (On Screen Display) and to control other accessories in the system
5. **Eject (▲) Button.**
6. **Power Button** – (Bright red when system is on dim when off).
7. **VOD705 DL /VOD705 DLS/VOD705 DLP Ventilation Opening.**
8. **Dome Lights** – provide additional Interior illumination.
9. **Three position Dome Light Switch**
 - Auto – Automatically switches on the dome lights in conjunction with the vehicle's interior illumination.
 - Off – The dome lights will not turn on in this position.
 - On – Turns on the dome lights.
10. **Screen Release** – Moves in direction of the arrow to release the drop down screen.
11. **Headphone Jack** - Allows the use of wired headphones with a 1/8" plug for listening to video program audio.
12. **FM Transmitter Channel Select** (Channel 1, 88.3MHz, Channel 2, 88.7MHz, Channel 3, 89.1MHz).
13. **Headphone Jack** - Allows the use of wired headphones with 1/8" plug for listening to video program audio.
14. **Source Select** (AV1, AV2, DVD, AUX).
15. **Screen Mode Button** - Allows the user to change screen format (Aspect Ratio, 4:3 or 16:9).
16. **Drop Down LCD Panel.**
17. **Auxiliary Audio Right Input.**
18. **Auxiliary Audio left Input.**
19. **Auxiliary Video Input.**
20. **Side Remote Sensor Eye** – Allows the remote control to operate the VOD705 DL/VOD705 DLS/VOD705 DLP and control other accessories in the system.
21. **LCD Panel Backlight Switch** – This switch turns off the LCD backlighting when the screen is in the closed position.

NOTE: Audiovox recommends the use of the Audiovox HP275 Headphones when using wired headphones.

REMOTE CONTROL OPERATION

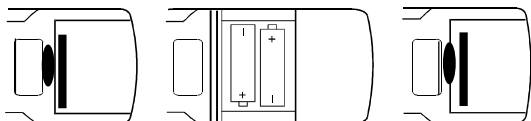

BATTERY INSTALLATION

Before attempting to operate your Remote Control, install the batteries as described below.

- 1) Turn the Remote Control face down. Using a fingernail, lift the battery cover off.
- 2) Install two “AAA” batteries as shown. Make sure that proper polarity (+ or -) is observed.
- 3) Align the cover tabs with the remote control and press down until the cover clicks.

The remote control will operate the VOD705 DL/ VOD705 DLS/VOD705 DLP. It is not a universal remote control and will not control equipment from other manufacturers.

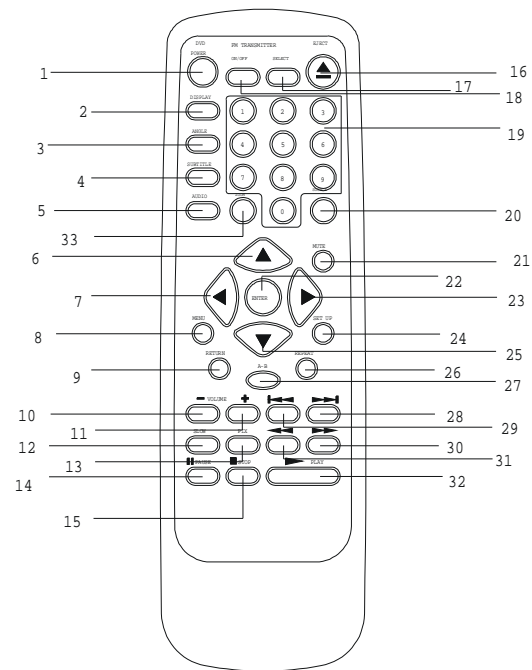

DVD Function Descriptions

*Function control is available on the unit and the remote control.

1. DVD POWER ON/OFF Button*

Press this button to turn the VOD705 DL/ VOD705 DLS / VOD705 DLP on. The DVD or selected video source will be displayed on screen and the picture will appear in a few seconds. Press the button again to turn the VOD705 DL/ VOD705 DLS/VOD705 DLP off.

2. DISPLAY Button

Display Menu, This includes Title, Chapter, Time, Audio, Subtitle, Angle, Repeat Bookmark and other information.

3. ANGLE Button

Allows the user to select the DVD angle if the DVD contains this feature.

4. SUBTITLE Button

Allows the user to select the DVD subtitle feature. Use cursor keys to highlight desired item, use ENTER to switch.

5. AUDIO Button

Allows the user to enter the Audio menu features (language spoken etc.) Use the (◀ ▶) buttons to highlight desired item, use the (▼▲) buttons to switch.

6. UP (▲) Button

Allows the user to scroll upwards in the menu options.

7. LEFT (◀) Button

Allows the user to shift left in the menu options.

8. MENU Button

Allows the user to access the main menu.

9. RETURN Button

Allows the user to exit the set up menu.

10. VOLUME DOWN (-) Button

Use these buttons to decrease the volume level of the headphone jacks. They are also used to make picture adjustments in picture select mode.

11. VOLUME UP (+) Button

Use these buttons to raise the volume level of the headphone jacks, They are also used to make picture adjustments in picture select mode.

NOTE: These buttons will not affect the volume of wireless headphones or a wired RF modulator. When using these devices the volume must be adjusted with the wireless headphone volume control or with your radio's volume control (see page 8, Headphones, or page 9, Wired FM Modulator).

12. SLOW Button

The DVD viewing speed will be reduced at 1/2, 1/4, 1/8 times of normal speed.

13. PIX Button (PICTURE SELECT)

Each time this button is pressed, the on screen picture adjustment display cycles through "adjustment bars" for BRIGHTNESS, CONTRAST, COLOR and TINT. Once the desired adjustment bar is displayed, use the VOLUME UP/DOWN buttons to adjust the setting. The display will automatically turn off if no adjustments are made within 6 seconds, or if any other button is depressed.

14. PAUSE (II) Button *

DVD disc play will be paused. During Disc Playback, momentarily press the PLAY Button to Pause the Disc from the unit.

15. STOP (■) Button *

DVD disc play will be stopped.

16. EJECT(▲) Button *

The disc will be ejected disc from disc compartment.

17. FM SELECT Button *

Selects the FM modulator Frequency (Frequency 1, 88.3MHz, Frequency 2, 88.7MHz, Frequency 3, 89.1MHz).

18. FM ON/OFF Button *

Turns FM Modulator power on/off.

* Function control is available on the unit and the remote control.

19. NUMBERS Buttons

Allows the user to enter the numbers 0 to 9 for selection of CD tracks, dvd chapters, and password setting.

20. SOURCE Button*

Video signals from video equipment connected to the audio / video inputs can be displayed on the monitor by pressing this button. Each time the button is pressed, the audio / video source will change in the following sequence: DVD, AV1, AV2 and AUX.

21. MUTE Button

Press this button to mute the audio while using wired headphones.

Pressing the button again restores sound to the previously set level.

22. ENTER Button

Used to select or switch a highlighted selection.

23. RIGHT (▶) Button

Allows the user to shift to the right in the menu options.

24. SETUP Button

Allows the user to select the DVD options (Language, Video, Audio, Rating, Exit). The setup display can be viewed only when the player is in stop mode.

25. DOWN (▼) Button

Allows the user to scroll downward in the menu options.

26. REPEAT Button

Allows the user to repeat various positions of a DVD, CD or MP3 and displays the repeat menu.

27. A-B REPEAT Button

Allows the user to repeat play of a DVD or CD from point A to point B.

28. NEXT (▶▶|) Button

Allows the user to skip to the next chapter or track.

29. PREVIOUS (|◀◀) Button

Allows the user to return to the previous chapter or track.

30. Scan Forward (▶▶) Button

Allows the user to search in a forward direction at 2,4, and 8 times the normal speed.

31. Scan Backward (◀◀) Button

Allows the user to search in a backward direction at 2,4, and 8 times the normal speed.

32. PLAY Button (▶)Button*

Press this button to activate the play mode while a disc is loaded into the disc compartment.

33. ZOOM Button

Allows the user to view a scene in a close-up mode.

*Function control is available on the unit and the remote control.

Turning the VOD705 DL/VOD705 DLS/ VOD705 DLP On or Off

1. Sliding the screen release lock forward will unlock the LCD screen and it will drop down slightly. Pivot the screen downward until a comfortable viewing angle is reached. The internal friction will hold the screen in position while the system is in use.
2. Pressing the power button on the unit or the remote control will turn the system on or off alternately. When in use the internal backlighting will illuminate the controls.
3. After the unit has been turned on and is displaying a picture, adjust the viewing angle, by pivoting the screen to optimize the picture quality.
4. Remember to turn the unit off and pivot the LCD to the locked position when not in use.

Overhead Dome Lights

Operation

The lights integrated into the VOD705 DL/VOD705 DLS/VOD705 DLP are controlled by a three position slide switch. Sliding the switch to the on position will turn the lights on. The off position will prevent the lights from turning on at all times, and the auto position will allow the lights to turn on and off with the vehicle's interior lighting. Refer to the Installation Manual for the wire connections. Do not leave the vehicle unattended with the dome light switch in the on position, as this could result in a discharged battery.

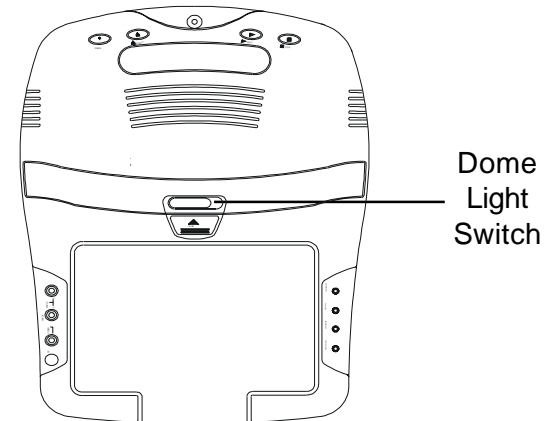

Remote Sensor

The VOD705 DL/VOD705 DLS/VOD705 DLP incorporates two Infrared sensors which relay signals from the remote control to allow the unit to be controlled simply by pointing its remote control at the remote sensor eye. The repeater function allows control of auxiliary equipment such as an Audiovox Video Cassette Player. The infrared sensor can relay signals from most manufacturer's remote controls to its respective component connected to the Video 1 and 2 inputs. In this case you must use the remote control supplied with the component.

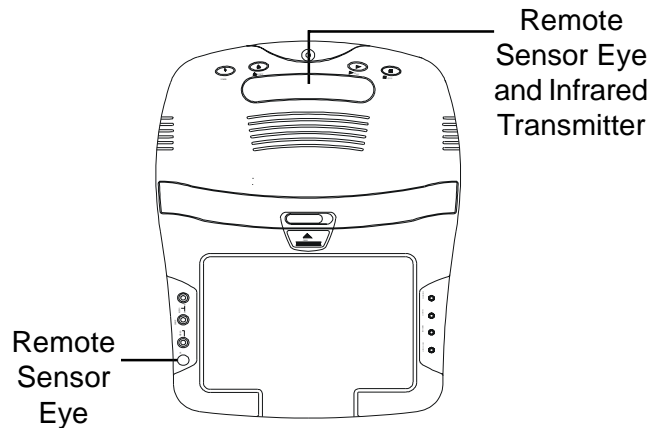

Accessories

Wireless Headphones

The VOD705 DL/VOD705 DLS/VOD705 DLP includes a built-in infrared transmitter for use with Audiovox wireless headphones (Part Number MVIRHS). The volume can then be adjusted using the controls on each headset. The wireless headphones must be used within a line of sight from the transmitter, as infrared transmissions, like visible light travel only in a straight line. See the documentation accompanying your Audiovox wireless headphones.

Headset Special Features

- Automatic Level Control prevents input signal over loading.
- Uses high frequency infrared light to assure a clean signal for clear reception.

Wired Headphones

There are two 1/8" headphone jacks on the VOD705 DL/VOD705 DLS/VOD705 DLP that can be used with any standard wired stereo headphones. These jacks are controlled by the volume up / down buttons on the VOD705 DL/VOD705 DLS/VOD705 DLP remote control. Remove the protective plastic cover to access the jacks. Remember to replace the cover when the jacks are not in use.

Wired FM Modulator

The VOD705 DL/VOD705 DLS/VOD705 DLP is equipped with an RF modulator, that allows you to listen to the VOD705 DL/VOD705 DLS/VOD705 DLP audio signal by tuning your vehicle's radio to the selected frequency, (88.3, 88.7 or 89.1). This feature is accessed by using either the FM transmitter buttons on the remote (On/Off, Select) or the FM Select button on the unit located under the plastic cover. Whenever the RF modulator is on, broadcast reception on the vehicles radio will be poor. Switching off the FM modulator will allow normal radio reception.

AV1 and AV2

The video inputs may be connected to a Video cassette Player (VCP), video game system, or other audio/video devices. To access the A/V inputs, turn the

VOD705 DL/VOD705 DLS/VOD705 DLP on and press the source button on the VOD705 DL/ VOD705 DLS/VOD705 DLP or the Source button on the remote control until "AV1 or AV2" is displayed on the screen. Turn the video source component on with its power button or remote control. The VOD705 DL/VOD705 DLS/VOD705 DLP is now ready to play the audio and video signals from the source connected to AV1 or AV2 inputs.

AUX Video Input

The VOD705 DL/VOD705 DLS/VOD705 DLP will accept an audio / video input through the RCA jacks located on the side of the unit. The audio / video device could be a video game system, video camera, or other input device.

Video Out

The VOD705 DL/VOD705 DLS/VOD705 DLP provides a video output for an optional video monitor(s). (Refer to page 6 of the Installation Guide for more details.) This output will provide a video signal that duplicates the signal displayed by the VOD705 DL/VOD705 DLS/VOD705 DLP to an additional monitor or video display. Please see your installer for more information.

DVD Basics

To get the optimum use out of the DVD section, make sure you read this section completely.

Regional Coding

Both the DVD player and disc are coded by region. These regional codes must match in order for the disc to play. If the codes don't match, the disc won't play. This unit's code is region 1. Other regional codes cannot be played in this unit. The unit will display "REGION CODE VIOLATION."

Types of Discs your DVD will play

DVD discs – DVDs discs which contain video.

Audio discs – Audio CDs contain musical or sound content only.

MP3 discs – A disc that contains audio files (for example, a CD-R with downloaded MP3 files).

VCD discs –VCD discs which contain video.

Loading and Playing Discs

Before you load a disc, make sure that it is compatible with the player.

NOTE: that the following Discs CANNOT be used with this player :

MiniDisc

Laserdisc

- CD-I, CD-ROM, CD-RW, DVD-ROM

To load and Play a Disc

When you press the Power button the unit will turn on and display the source selected. Select DVD mode and insert the disc (Label Up) into the disc compartment. When the disc is half way in it will be automatically pulled in and play will begin.

Settings and Adjustments

This chapter describes how to set and how to adjust using the on-screen SETUP menu.

Using the Setup Display

Using the setup display, you can do the initial setup, adjust the picture and sound quality, and set the various outputs. You can also set a language for the subtitles and the setup display and limit play back by children.

Note: You can display the setup display only when the player is in stop mode.

- 1) Press the SETUP button to display the “setup menu” on the TV screen.

- 2) Select the main item you want using the cursor (◀▶) buttons, and then press the ENTER button.

To Cancel Using the Setup Display

Press the SETUP button on the remote.

To Return to the Previous Menu

Press the (◀) button or RETURN on the remote.

Setting the Language for Display and Sound (LANGUAGE SETUP)

Press the SETUP button and using the (▼▲) buttons select “LANGUAGE”. Press the ENTER button. The Language Setup allows the user to set various languages for the on-screen display or sound.

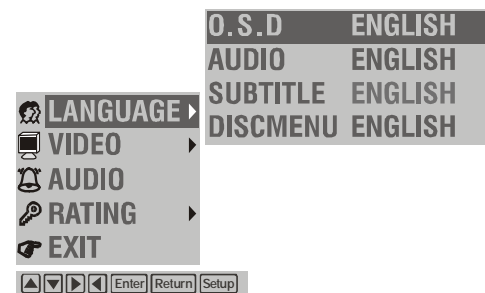

OSD (On-Screen Display) Language Menu

The OSD Language Menu allows the user to select the language for the on-screen display. Press ENTER and then use the (▼▲) buttons to select the desired language. The user can select either English, Français, Italiano, Español or Deutsch for the OSD language. Then press ENTER to confirm your selection.

Audio Language Menu

The Audio language menu allows the user to choose the preferred audio language. Press ENTER and then use the (▼▲) buttons to select the desired language. English, French, Italian, Spanish, German. Then press ENTER to confirm your selection.

Subtitle Menu

The Subtitle Language menu allows the user to choose the preferred language for subtitles. Press ENTER and then use the (▼▲) buttons to select the desired language. The user can select English, French, Italian, Spanish, German. Then press ENTER to confirm your selection.

Disc Menu

The Disc Menu allows the user to choose the preferred language for the disc start menu. Press ENTER and then use the (▼▲) buttons to select the appropriate setting. The user can select English, French, German, Spanish, or Italian. Then press ENTER to confirm your selection.

Settings for Video

Press the SETUP button and select VIDEO. The VIDEO SETUP allows you to adjust the display playback conditions.

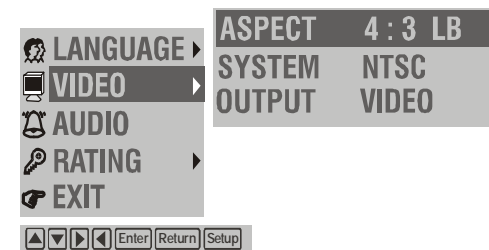

System Settings

Aspect

This menu allows the user to select the aspect ratio of the monitor. Press ENTER and then use the (▼▲) buttons to select the appropriate setting.

4:3 LB (LETTER BOX) : This displays a wide picture with black bands on the upper and lower portions of the screen.

4:3 PS (PAN SCAN) : This displays the wide picture on the screen with a portion of the left and right sides removed.

16:9 WS (WIDE SCREEN) : This displays a picture with black bands on the upper and lower portions of the screen.

Then press ENTER to confirm your selection.

System Menu

NTSC format only.

Output

Video format only.

NOTE: Depending on the DVD, 4:3 LETTER BOX may be selected automatically instead of 4:3 PAN SCAN and vice versa.

Settings for Audio

Press the SETUP button and select AUDIO.

The AUDIO menu is shown analog 2CH format.

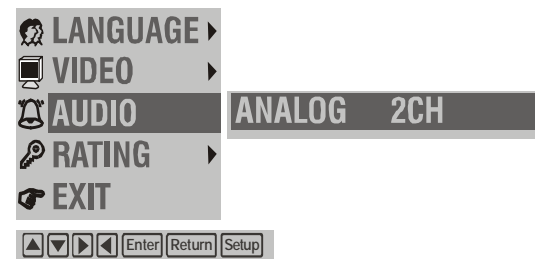

Settings for Rating (Parental Control)

This section of the SETUP Menu allows users to control the content of movie playback from 1 (Children) to 8 (Adult).

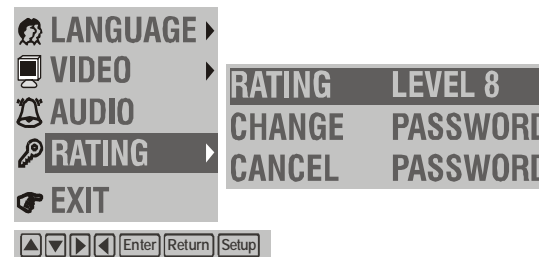

Limiting Playback by Children (Parental Control)

The Parental Control function allows you to limit viewing to your preference.

1. Use the (▼▲) buttons to select RATING, then press ENTER.
2. Enter a password in 4 digits using the number buttons, then press the ENTER button.
3. Select LEVEL using the (▼▲) buttons.
LEVEL 8 : Adult
LEVEL 7
LEVEL 6
LEVEL 5
LEVEL 4
LEVEL 3
LEVEL 2
LEVEL 1 : Children

The lower the value, the more strict the limitation.
Press the ENTER button.

Changing and Canceling the Password

To change the password, use the (▼▲) button to select CHANGE PASSWORD, then press ENTER. Enter the old password and then type in the new password using the number keys and press ENTER. To cancel the password, use the (◆♦) button to select CANCEL PASSWORD then press ENTER. Enter password then press ENTER the OSD display "PSW CANCELED".

Playing DVD, CD and MP3 Disc

Using the On-screen Icons display

The on-screen icons display contains many playback features. To see the icon display, use the DISPLAY button on the remote while a disc is playing. Each feature of the icon display is illustrated with an icon. Use the left/right arrow buttons (◀ ▶) on the remote to move through the different icons in the icon display. When an icon is highlighted, use the up/down arrow buttons (↕) on the remote to scroll through the choices displayed in the text box under the icon.

Remember, you can only access the icon display when you are playing a disc. Also, the icon display features are only available if the disc was created with that particular feature (i.e., if you select the Subtitle icon, you will not be able to change the subtitle language unless the author of the disc created the disc with different subtitle languages).

The invalid symbol appears on the screen when you press a button that does not have any function. To make the icon display disappear from the screen, press display on the remote unit it disappears.

Playing DVD Disc



Title



Displays current title. Use the (◀ ▶) buttons to move the cursor to the icon, use the (ts) buttons to select required title, press ENTER to confirm the selection.

Chapter

Display current chapter. Use the (◀ ▶) buttons to move the cursor to the icon, use the (ts), or Number buttons to select the required chapter, press ENTER to confirm the selection.

Time



Displays the elapsed time.

Audio Channel



Audio channel selection. Use the (◀ ▶) buttons to move the cursor to the icon, use the (ts) buttons to select the required audio channel.

Q

Qsurround function. Use the (◀ ▶) buttons to move the cursor to the icon, use the (ts) buttons to select QSURROUND function on or off.

Subtitle



Display current subtitle language. Use the (◀ ▶) buttons to move the cursor to the icon, use the (ts) buttons to select the required subtitle language or switch on/off the subtitle.

Angle



Multi-angle switch. Use this menu to select angles of pictures being played. Use the (◀ ▶) buttons to move the cursor to the icon, use the (ts) buttons to select required angle.

NOTE: Not all DVDs have this feature.

NOTE: The following functions can be accessed by pressing the DISPLAY button twice or by pressing the display button once and using the (▶) button or by pressing the REPEAT button.

Repeat



Repeat play function. Use the (◀▶) buttons to move the cursor to the icon, use the (ts) buttons or REPEAT button to select required repeat play function.

Repeat Chapter → Repeat Title → Repeat Disc → Repeat Off

Repeat A-B



Repeat play from A to B selected. Use the (◀▶) button to move the cursor to the icon, use the A-B button or ENTER button to select the A and B points.

Set Start Point A → Set End Point B → Cancel Repeat
use the (◆◆) or A-B button to cancel.

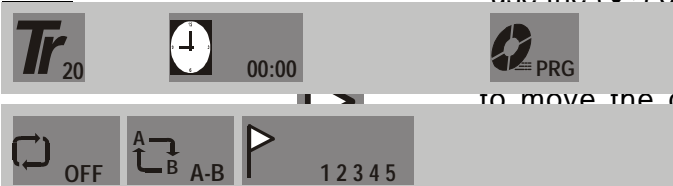

Use the (◀▶) buttons to move the cursor to the icon. At bookmarks (1,2,3,4,5) this operation is valid only when "BOOKMARK" is displayed on OSD. You may use the (◀▶) to move the cursor to a bookmark and press ENTER to jump to the position set and play.

Playing CD Disc

Track



Displays current track. Use the (◀▶) buttons to move the cursor to the icon, use the (ts) buttons or Number Keys (0 to 9) to select required track, press ENTER to confirm the selection.

Time

Displays the elapsed time.

Play mode



Play mode selection. Use the (◀▶) buttons to move the cursor to the icon, use the (ts) buttons to select any of the three play modes: Sequential (Off), Programmed and Random play modes.

Repeat



Repeat play function. Use the (◀▶) buttons to move the cursor to the icon, use the (ts) buttons or REPEAT button to select required repeat play function.

Repeat A-B



Repeat play from A to B selected. Use the (◀▶) buttons to move the cursor to the icon, use the ENTER or A-B button to select the required repeat play function.

Set Start Point A → Set End Point B → Cancel Repeat
use the (◆) or A-B button to cancel.

Playing MP3 Disc

MP3 is format for storing digital audio. An audio CD quality song can be compressed into the MP3 format with very little loss of quality, while taking up much less space. CD-R discs that have been encoded in MP3 format can be played on your DVD. For basic information about loading and playing discs, go to page 10.

MP3 discs contain individual songs that can be organized into directories. When you play an MP3 disc, the MP3 info display appears as shown below.

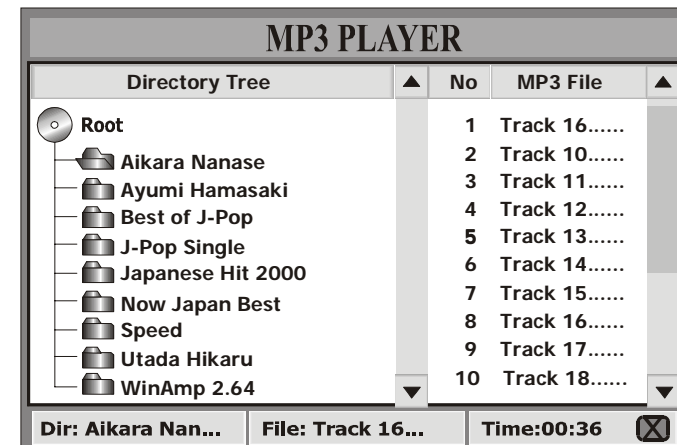

Playback begins automatically when you insert an MP3 disc into the player. The TV/DVD/Radio begins playing the songs in the order they were burned onto the disc.

Selecting a directory

Because MP3 discs contain a large number of songs, these songs are divided into directories. To select a directory:

1. While a disc is playing, press the left arrow buttons (◀) to highlight the directory icon.
2. Press the up/down arrow buttons (▼▲) to go to the next or previous directory.
3. Press ENTER on the remote to go to that directory.



Selecting a song

To select a specific song:

1. While the disc is playing, use the number button(s) on the remote to enter the song number, or press the up/down arrow buttons (▼▲) to go to the next or previous song.
2. Press ENTER on the remote.

TIP
You can also advance to the next song by pressing ►►, or go to the preceding song by pressing ◀◀ the remote.

No	MP3 File
1	Track 16.....
2	Track 10.....
3	Track 11.....
4	Track 12.....
5	Track 13.....
6	Track 14.....
7	Track 15.....
8	Track 16.....
9	Track 17.....
10	Track 18.....

Directory Display

This feature displays the directory that you have selected.



File Display

This feature displays the selected track number which contains in the selected directory.

Time Display

This feature displays the audio time for the length of the song. Each time you make a song, the time restarts from the beginning.

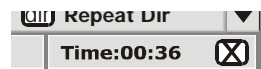

Repeat Feature

The default mode for the Repeat feature is Off. There are 4 Repeat options:

1. Repeat Off - All the songs will be playing once
2. Repeat One - Repeat the song that is playing
3. Repeat Disk - Repeat the disc that is playing
4. Repeat Dir - Repeat the directory that is playing

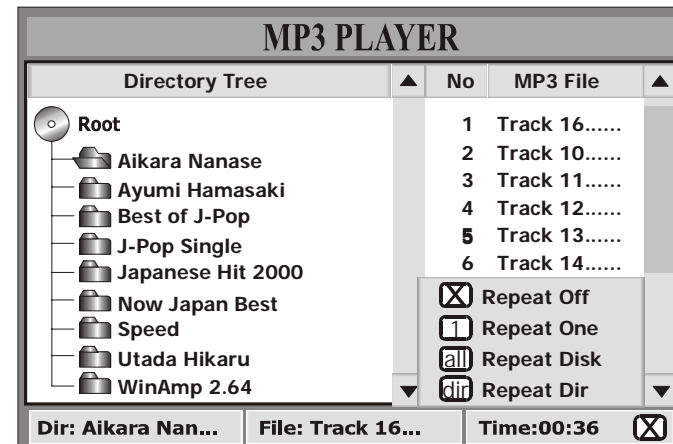

To Use Repeat Feature:

1. While a disc is playing, press Repeat button or right arrow button (►) on the remote to bring up the Repeat icon.
2. Press the up/down arrow buttons (▼▲) to highlight the Repeat option (Repeat Off, Repeat One, Repeat Disk, Repeat Dir).
3. Press ENTER on the remote. The selected repeat option will shown on the right side of Time Display.

Troubleshooting

PROBLEM	SOLUTION
Poor in vehicle radio reception (FM modulator installed)	<ul style="list-style-type: none">• Check the condition of the vehicle's radio antenna.• Verify that the antenna is fully raised.• If a wired RF modulator has been installed, verify that it is turned OFF by using remote.
Remote inoperative	<ul style="list-style-type: none">• Verify that the batteries in the remote are fresh.• Verify that the remote sensor eye is not obstructed.• Verify that the infrared transmitter is affixed over the sensor eye of the component to be controlled.
Disc won't play	<ul style="list-style-type: none">• Insert a disc with the label side facing up.• Check the type of disc you put into disc tray. This DVD only plays digital video discs, audio CDs and MP3s.• Both the unit and the disc are coded by region. If the regional codes don't match, the disc can't be played. This DVD is Region Number 1.
Play starts, but then stops immediately	<ul style="list-style-type: none">• The disc is dirty. Clean it.• Condensation has formed. Allow player to dry out.

-20-

128-6247B

23 of 24

PROBLEM	SOLUTION
No sound or distorted sound	<ul style="list-style-type: none"> • Make sure your DVD is connected properly. Make sure all cables are securely inserted into the appropriate jacks. • If you are using the IR headphones, make sure you turn on the IR power. • Make sure Modulator is ON and the proper Frequency has been selected.
Can't advance through a movie	<ul style="list-style-type: none"> • You can't advance through the opening credits and warning information that appears at the beginning of movies because the disc is programmed to prohibit that action.
The icon (Ⓢ) appears on screen	<p>The feature or action cannot be completed at this time because:</p> <ol style="list-style-type: none"> 1. The disc's software restricts it. 2. The disc's software doesn't support the feature (e.g., angles) 3. The feature is not available at the moment. 4. You've requested a title or chapter number that is out of range.

PROBLEM	SOLUTION
Picture is distorted	<ul style="list-style-type: none"> • The disc might be damaged. Try another disc. • It is normal for some distortion to appear during forward or reverse scan.
No forward or reverse scan	<ul style="list-style-type: none"> • Some discs have sections that prohibit rapid scanning or title and chapter skip. • If you try to skip through the warning information and credits at the beginning of a movie, you won't be able to. This part of the movie is often programmed to prohibit skipping through it.

Replacement Parts		Specifications	
Remote Control	136B2127	LCD Backlighting	Edge Light Tube
		Resolution	1440 x 234
Left Protective Cover for IR Sensor	102B3687	Pixels	336,960
		Operation Temperature	32 -140° F (0 - 60° C)
Right Protective Cover for		Storage Temperature	-4 - 176° F (20 - 80° C)
Headphones Jacks	102B3688	Backlight life	10,000 Hours
		Video Display System	NTSC/PAL
		Headphone Audio Output	0.03W @ 32 ohms
		Low Level Audio Output	620 mvp-p
		1 kHz @ -15 dB	
		Video Output	1.0Vp-p @ 75 ohms
		Power Source	12V DC



36 MONTH LIMITED WARRANTY

Applies to Audiovox Mobile Video Products

AUDIOVOX ELECTRONICS CORP. (the Company) warrants to the original retail purchaser of this product that should this product or any part thereof, under normal use and conditions, be proven defective in material or workmanship within 36 months from the date of original purchase, such defect(s) will be repaired or replaced with reconditioned product (at the Company's option) without charge for parts and repair labor.

To obtain repair or replacement within the terms of this Warranty, the product is to be delivered with proof of warranty coverage (e.g. dated bill of sale), specification of defect(s), transportation prepaid, to the Company at the address shown below.

This Warranty does not extend to the elimination of externally generated static or noise, to correction of antenna problems, to costs incurred for installation, removal or reinstallation of the product, or to damage to tapes, discs, speakers, accessories, or vehicle electrical systems.

This Warranty does not apply to any product or part thereof which, in the opinion of the Company, has suffered or been damaged through alteration, improper installation, mishandling, misuse, neglect, accident, or by removal or defacement of the factory serial number/bar code label(s). THE EXTENT OF THE COMPANY'S LIABILITY UNDER THIS WARRANTY IS LIMITED TO THE REPAIR OR REPLACEMENT PROVIDED ABOVE AND, IN NO EVENT, SHALL THE COMPANY'S LIABILITY EXCEED THE PURCHASE PRICE PAID BY PURCHASER FOR THE PRODUCT.

This Warranty is in lieu of all other express warranties or liabilities. ANY IMPLIED WARRANTIES, INCLUDING ANY IMPLIED WARRANTY OF MERCHANTABILITY, SHALL BE LIMITED TO THE DURATION OF THIS WRITTEN WARRANTY. ANY ACTION FOR BREACH OF ANY WARRANTY HEREUNDER INCLUDING ANY IMPLIED WARRANTY OF MERCHANTABILITY MUST BE BROUGHT WITHIN A PERIOD OF 48 MONTHS FROM DATE OF ORIGINAL PURCHASE. IN NO CASE SHALL THE COMPANY BE LIABLE FOR ANY CONSEQUENTIAL OR INCIDENTAL DAMAGES FOR BREACH OF THIS OR ANY OTHER WARRANTY, EXPRESS OR IMPLIED, WHATSOEVER. No person or representative is authorized to assume for the Company any liability other than expressed herein in connection with the sale of this product.

Some states do not allow limitations on how long an implied warranty lasts or the exclusion or limitation of incidental or consequential damage so the above limitations or exclusions may not apply to you. This Warranty gives you specific legal rights and you may also have other rights which vary from state to state.

U.S.A. : AUDIOVOX ELECTRONICS CORPORATION, 150 MARCUS BLVD., HAUPPAUGE, NEW YORK 11788 • 1-800-645-4994

CANADA : CALL 1-800-645-4994 FOR LOCATION OF WARRANTY STATION SERVING YOUR AREA

© Copyright 2002 Audiovox Electronics Corp. 150 Marcus Blvd. Hauppauge, NY 11788

128-6247B

26 of 24

NOTES

128-6247B
27 of 24



For Customer Service
Visit Our Website At
www.audiovox.com
Product Information, Photos,
FAQ's Owner's Manuals

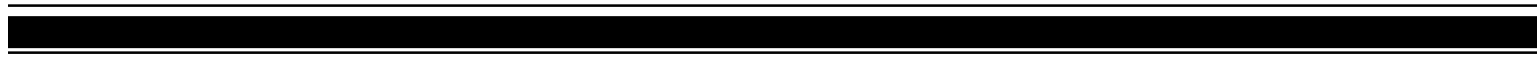

© 2002 Audiovox Electronics Corp., Hauppauge, NY 11788

128-6247A

128-6247B
28 of 24

Free Manuals Download Website

<http://myh66.com>

<http://usermanuals.us>

<http://www.somanuals.com>

<http://www.4manuals.cc>

<http://www.manual-lib.com>

<http://www.404manual.com>

<http://www.luxmanual.com>

<http://aubethermostatmanual.com>

Golf course search by state

<http://golfingnear.com>

Email search by domain

<http://emailbydomain.com>

Auto manuals search

<http://auto.somanuals.com>

TV manuals search

<http://tv.somanuals.com>