

CDM-9100

for

Bell Mobility

***OWNER'S OPERATING
MANUAL***



AUDIOVOX

CDM-9100

Tri-Mode CDMA/AMPS Handheld Portable Cellular Telephone

In today's fast paced world, it has become a necessity to have access to real-time information. Your communications tools must provide you with this access from anywhere at anytime. With that in mind, Audiovox developed the CDM-9100, our next generation tri-mode web browsing wireless handset.

The CDM-9100 operates on the 800 MHz Amps/CDMA and 1900 MHz PCS frequencies allowing for seamless nationwide coverage. The digital handset features easy-to-use internet navigation keys, vibrating alert, and data capabilities. It also has "masques", user-changeable face plates, enabling you to express your individuality through your wireless handset. In addition, the phone features menu driven operation, a built-in one-way speaker phone, enhanced phonebook, one-touch emergency dialing, and 15 distinctive ringer options. And with the lithium ion battery pack, you will get 170 minutes of talk time and 170 hours of standby time.

The CDM-9100 has several optional accessories available, including: simple hands-free devices, cigarette lighter adapter, desktop charger, travel charger, data interface cable, belt clip, leather carrying case and of course, "masques".

Your new CDM-9100 provides you with something only an Audiovox phone can: the proven reliability that has made us a leading wireless handset provider. Please take a few moments to read the following pages of the owner's operating manual. It will help you make the most efficient use of this valuable communications tool.

TABLE OF CONTENTS

SAFETY INSTRUCTIONS	7
SAFETY INFORMATION FOR WIRELESS HANDHELD PHONES	14
SAR Information	17
SYSTEM CONFIGURATION	18
BATTERY INSTALLATION AND RECHARGING ..	19
To Attach the Battery Pack	19
To Detach the Battery Pack	19
To Recharge Battery	20
FUNCTIONS	22
External View	22
Function of Keys	23
LCD Display Indication	23
GETTING STARTED	24
Turning the Phone On/Off	24
Antenna Position	24
Receiving Signal Strength Indicator (RSRP)	24
Battery Level Indicator	24
Power Management	24
BASIC OPERATION	25
Placing Calls	25
To Place a Call	25
To Terminate a Call	25
Last Number Redial	25
To Dial the Last Number Received	25
Phonebook Dialing	25
Speed Dialing	26
Quick Dialing	26
Emergency Call	26
One-Touch Emergency Call	27
Emergency Call Mode	27
Receiving Calls	27
To Receive a Call	27
Any Key Answering	27
Caller ID with Name	28
Automatic Calls-in-Absence Indicator	28
Ringing Tone with Melody	28
Distinctive Ringing (Audible Caller ID)	28
During Calls	28
To Adjust the Earpiece Volume	28
To Mute a Phone Conversation	29
Speakerphone Mode (One-Way)	29
Automatic Talk Timer	29
Scratch Pad Dialing	29
Call Waiting	29
Three-Way Calling	30
Standby	30
Indicators on Standby	30
Vibrating Alert	30
Multilingual	30

End to End Signaling	31
Touch Tone™ from Display	31
Touch Tone™ from Memory	31
Entering Letters and Symbols	32
T9 Mode T9 (T9)	32
Alpha Mode abc (abc)	32
Numeric Mode Num (Num)	33
Symbol Mode Sym (Sym1 to 4)	33
PHONEBOOK OPERATION	34
Phonebook Entry	34
Basic Sequence	34
To Store a Number without Name	35
Automatic Storing into Phonebook	35
Auto Hyphenation	36
Manual Hyphenation	36
To Store Dual Numbers in Phonebook	37
To Store a Name with the Phone Number	38
To Store E-mail Address	39
To Mark Numbers with Icon	39
To Store a Ringer Type with the Phone Number ...	40
Overwrite Warning	41
Recall Menu	42
Recall Menu Tree	42
Phonebook Recall	43
Phonebook Address Mode	43
Phonebook Sort Scroll Mode	43
Phonebook Key Word Search Mode	44
To Dial Dual Numbers	45
To Review Long Names and Numbers	45
To Review E-mail Address	45
Prepending Dialing	45
Phonebook Edit	46
To Modify Numbers and Names	46
To Move Numbers and Names	47
To Change Priority of Dual Numbers	48
To Erase Numbers and Names	48
Secret Memory	49
To Store a Secret Number	49
To Recall a Secret Number	50
Link Dialing	50
To Store Linked Numbers in Phonebook	50
To Place Calls Using Linked Numbers	51
Call History	52
To Review Outgoing Call History	53
To Review Incoming Call History	53
To Review Scratch Pad	54
To Save a Number to Phonebook	54
MESSAGING FEATURES	55
Receiving Text Messages	56
To Check Received Messages	56
Sending Text Messages	57
To Send a Text Message	57
To Review Sent Messages	58
Voice Mail	59
Voice Mail Notification	59
Voice Mail Dialing 	60

Messaging Feature Settings	61
Default Call Back #	61
Default Delivery Ack	61
New Message Alert	61
Voice Mail Alert	62
Text Entry Mode	62
Save Sent Message	62
Erase All Text Messages	62
SMS Text Lines Selection	62
SMS Memory Management	62
WEB BROWSING	63
Accessing Internet.....	63
To Start Web Browser	63
Browser Menu	64
E-mailing with Browser	64
To Send and Receive E-mails	64
Net Alert with Browser	65
To Receive Net Alert	65
To Check Alert Inbox	65
Web Browser Settings	65
Web Lock	65
Web Backlight	65
Web Idle Timer	65
Confirm — Connect Prompt	66
Connection Settings	66
FUNCTION MENU.....	67
To Access Function Menu.....	67
Function Menu Tree	68
Lock Features	69
Security Code and Unlock Code	69
Keypad Lock (F11)	69
Phone Lock (F12)	70
Automatic Phone Lock (F13)	70
To Unlock the Phone	70
To Change the Unlock Code (F14)	70
Display Features	71
Own Telephone Number Display (F21)	71
Backlight Control (Standby) (F22-1)	71
Backlight Control (In-Use) (F22-2)	72
Auto Hyphenation (F23)	72
Language Selection (F24)	72
Contrast Control (F25)	72
Software Version Review (F26)	73
Last Rescan SID Indicator (F27)	73
PRL ID Review (F28)	73
Volume and Tone Controls	73
Ringer Volume Control (F31)	73
Ringer Type Selection (F32)	74
Key Tone Volume Control (F33)	74
Sending DTMF (F34)	74
Key Tone Length (F35-1)	74
Single Alert Beep Tone (F35-2)	75
Caller ID Alert (F35-3)	75
Service Mode Alert (F35-4)	75
Voice Privacy Alert (F35-5)	75
One Minute Beep Tone (F35-6)	76
Low Battery Alarm (F35-7)	76

Call Timers	76
Last Call Timer (F41-1)	76
Outgoing Call Timer (F41-2)	76
All Calls Timer (F41-3)	77
Lifetime Timer (F41-4)	77
Web Total Timer (F41-5)	77
Clock Indicator (F42)	77
Clock Adjustment (F43)	77
Clock Alarm (F44)	78
Countdown Timer (F45)	79
System Features	80
System Mode Selection (F51)	80
Enhanced Roaming	80
NAM Selection (F52)	81
Force Analog Call (F53)	81
NAM Name Display (F54-1)	82
Automatic NAM (F54-2)	82
Automatic Retry (F54-3)	82
Enhanced Voice Privacy Service (F54-4)	83
Security Features	84
Call Restriction (F61)	84
To Change Emergency Numbers (F62)	84
To Turn On/Off One-Touch Emergency Call Feature (F63) ..	85
To Change the Security Code (F64)	85
Call Timer Reset (F65-1)	85
Phonebook All Clear (F65-2)	85
Call History All Clear (F65-3)	86
Text Message & Voice Mail All Clear (F65-4)	86
Function Reset (F65-5)	86
Data Communications	87
Data/Fax Mode (F71)	87
Vibrator	88
Vibrating Alert (F8)	88
Other Functions	89
Quick Dialing (F01)	89
Automatic Answering (F02)	89
Redial Soft Key (F04)	89
Function Reset Status	90
FACEPLATE OPTIONS	92
FDA Consumer Update	94
OPERATING PROCEDURES	98
Emergency Calls	98
INDEX	99
12 MONTH LIMITED WARRANTY	101
Quick Reference	103
ACCESSORIES	105

Touch Tone™ is a registered trademark of AT & T.



SAFETY INSTRUCTIONS

WARNING : Always read and understand all of the **Warnings and Safety Instructions** contained in this Manual before attempting to use this Audiovox CDM-9100 Cellular Phone, to help avoid potential hazards that could result in bodily injury or property damage.

Always keep this Manual conveniently available for future reference, as it contains important information that will help effect the safe operation and maintenance of this instrument.

The safety instructions have been classified according to the seriousness of the risk, as follows :

DANGER : “**Danger**” indicates the existence of a hazard that could result in death or catastrophic bodily injury, if the safety instruction is not observed.

WARNING : “**Warning**” indicates the existence of a hazard that could result in serious bodily injury, if the safety instruction is not observed.

CAUTION : “**Caution**” indicates the existence of a hazard that could result in minor bodily injury or property damage, if the safety instruction is not observed.

NOTICE : “**Notice**” contains general information that relates to the safe operation of the telephone.

Safe Operation of Your Phone

WARNING

- Never attempt to disassemble the phone or any of its accessories. If service or repair is required, return the unit to an Audiovox authorized service center. If the unit should be disassembled, a risk of electric shock or fire may result.
- Always use authorized Audiovox accessories and optional devices when operating this cellular phone, as the use of incompatible auxiliary equipment could result in fire, electric shock or other bodily injury. The use of unauthorized accessories will also void your Warranty.

Protection of Children

- Never allow children to play with your phone, as they might hurt themselves or others (e.g., by poking themselves or others in the eye with the antenna).
- Always keep all accessories and components out of the reach of small children. Small parts, in particular, might present a choking hazard to children.

Use in Vehicles

- Never store or transport flammable liquids, gases or explosive materials in the same compartment as the phone or any of its accessories, as possible sparking in the equipment could ignite a fire or explosion.
- Always secure the phone in its holder, when it is not in use. Never place the phone on the passenger seat or anyplace else in the car where it can become a projectile during a collision or sudden stop.

CAUTION

- Never expose this phone to high temperatures, such as those found near a heater or in a closed car parked in the sun. This can cause heat-damage to the plastic parts, the electronic components and the battery.
- Never drop this phone or subject it to violent impact or shock. This can cause mechanical damage.
- Never allow any liquids to spill on this phone or expose it to rain, water or moisture. This can cause corrosion damage.
- Never store this phone in cold areas. When the phone warms up (to its normal operating temperature), moisture can form inside the phone, which may damage the phone's electronic circuit board.
- Never use harsh chemicals, cleaning solvents, or strong detergents to clean this phone. Always clean it with a soft cloth that has been slightly dampened in a mild soap-and-water solution.
- Never paint this phone. This can clog the moving parts.

Before connecting this cellular phone or any of its accessories to any other device, always read the Instruction Manual for that other device first to obtain detailed safety instructions. Never connect this cellular phone to any unauthorized or incompatible auxiliary product that has not been expressly approved by Audiovox.

Safe Operation of Battery Pack

WARNING

- Never short-circuit a battery pack by either accidentally or intentionally bringing the terminals in contact with another metal object. That could result in burns, other bodily injury or a fire, and could also damage the battery pack.
- Never expose the terminals of the battery pack to any other metal object. Always wrap it or place it in a plastic bag, whenever transporting it.
- Never heat and never attempt to disassemble the battery pack, as that could cause leakage of the caustic electrolyte. If the battery is accidentally broken, avoid skin contact with the contents. In the event of skin contact, wash the affected area immediately and obtain prompt medical attention.
- Never attempt to dispose of a battery pack by throwing it into a fire. That can cause the battery pack to explode.
- Never attempt to use an unauthorized battery pack with your phone in order to avoid any risk of bodily injury or property damage. Since unauthorized accessories have different specifications, they may be incompatible with your phone.

WARNING

Safe Disposal of Used Battery Packs

- Never discard a used battery pack with ordinary solid wastes, since it contains toxic substances.
- Always dispose of a used battery pack in accordance with prevailing community regulations relating to the disposal of household toxic wastes. Always cover the metal terminals with insulating tape first, to prevent accidental short-circuiting.



CAUTION

- Always turn your phone OFF before removing the battery pack, and always use the battery pack for its intended purpose only.
- Always use the battery pack supplied by Audiovox, or an approved replacement battery pack, to avoid any risk of damage to your cellular phone.

Safe Operation of AC Adapter

The AC Adapter and the Desktop Charger that were designed by Audiovox for this unit both require the use of a standard 120 V AC power source for their operation.

DANGER

- Never attempt to disassemble or repair an AC adapter or desktop charger, as exposure to electric shock hazards may result. Always contact an Audiovox authorized service center, if repair or replacement is required.
- Never alter the AC cord or plug on your AC adapter or desktop charger. If the plug will not fit into the available outlet, have a proper outlet installed by a qualified electrician. Improper connection can result in the risk of electric shock.

WARNING

- Never allow any liquids or water to spill on the AC adapter or desktop charger when it is connected to an AC power source. There is a risk of fire or electric shock.
- Always use the authorized Audiovox AC adapter or desktop charger to avoid any risk of fire or damage to your cellular phone or battery. Bodily injury or property damage may occur as a result of the use of an unauthorized and incompatible AC adapter or desktop charger.
- Never use an AC adapter or desktop charger if it has a damaged or worn power cord or plug. The use of damaged or worn power cords or plugs could result in electric shock, burns or fire. Contact an Audiovox authorized service center immediately to obtain a suitable replacement.

WARNING

- Always unplug the AC adapter or desktop charger from the power source before attempting any cleaning in order to avoid the risk of electric shock. Always use a soft cloth dampened with water to clean the equipment, after it has been unplugged.
- Never attempt to use an unauthorized AC adapter or desktop charger with your phone in order to avoid any risk of bodily injury or property damage. Since unauthorized accessories have different specifications, they may be incompatible with your phone.

CAUTION

- Always confirm that the power cord for any accessory is located so that it will not be stepped on, tripped over, or otherwise subjected to damage or stress.
- Never place heavy objects on a power cord, as this could result in damage to the cord.
- Never bend or twist a power cord, and never pull on a power cord in an attempt to remove an AC adapter or accessory plug from a socket. Always grasp the AC adapter or the accessory plug directly when unplugging the device in order to avoid damaging the cord.
- Always disconnect the AC adapter or desktop charger from the power source when it is not in use.

SAFETY INFORMATION FOR WIRELESS HANDHELD PHONES

Read this information before using your handheld portable Cellular Telephone.

Your wireless handheld portable telephone is a low power radio transmitter and receiver. When it is ON, it receives and also sends out radio frequency (RF) signals.

FCC RF EXPOSURE INFORMATION

In August 1996, the Federal Communications Commission (FCC) of the United States, with its action in Report and Order FCC 96-326, adopted an updated safety standard for human exposure to radio frequency (RF) electromagnetic energy emitted by FCC regulated transmitters. Those guidelines are consistent with the safety standard previously set by both U.S. and international standards bodies. The design of this phone complies with the FCC guidelines and these international standards.

Use only the supplied or an approved antenna. Unauthorized antennas, damaged antennas, modifications, or attachments could impair call quality, damage the phone, or result in violation of FCC regulations. Please contact your local dealer for replacement antenna.

Body-worn Operation

This device was tested for typical body-worn operations with the BC-9100 belt-clip and LB-9100 holster models, offered by Audiovox as an accessory to this phone, and found to comply with FCC RF exposure requirements. Third-party belt-clips, holsters and similar accessories should be avoided, as they have not been tested and may not comply with FCC RF exposure limits.

For more information about RF exposure, please visit the FCC website at www.fcc.gov .

PHONE OPERATION

Normal position: Hold the phone as you would any other telephone with the antenna pointed up and over your shoulder.

Tips on Efficient Operation:

For your phone to operate most efficiently:

- Extend your antenna fully.
- Do not touch the antenna unnecessarily when the phone is in use. Contact with the antenna affects call quality and may cause the phone to operate at a higher power level than otherwise needed.

DRIVING

Check the laws and regulations on the use of wireless telephones in the areas where you drive. Always obey them. Also, if using your phone while driving, please:

- Give full attention to driving — driving safely is your first responsibility.
- Use hands-free operation, if available.
- Pull off the road and park before making or answering a call if driving conditions so require.

ELECTRONIC DEVICES

Most modern electronic equipment is shielded from RF signals. However, certain electronic equipment may not be shielded against the RF signals from your wireless phone.

Pacemakers

The Health Industry Manufacturers Association recommends that a minimum separation of six (6") inches be maintained between a handheld wireless phone and a pacemaker to avoid potential interference with the pacemaker. These recommendations are consistent with the independent research by and recommendations of Wireless Technology Research.

Persons with pacemakers:

- Should ALWAYS keep the phone more than six (6") inches from their pacemaker when the phone is turned ON.
- Should not carry the phone in a breast pocket.
- Should use the ear opposite the pacemaker to minimize the potential for interference.
- If you have any reason to suspect that interference is taking place, turn your phone OFF immediately.

Hearing Aids

Some digital wireless phones may interfere with some hearing aids. In the event of such interference, you may want to consult your service provider [or call the customer service line to discuss alternatives].

Other Medical Devices

If you use any other personal medical device, consult the manufacturer of your device to determine if they are adequately shielded from external RF energy. Your physician may be able to assist you in obtaining this information.

Turn your phone OFF in health care facilities when any regulations posted in these areas instruct you to do so. Hospitals or health care facilities may be using equipment that could be sensitive to external RF energy.

Vehicles

RF signals may affect improperly installed or inadequately shielded electronic systems in motor vehicles. Check with the manufacturer or its representative regarding your vehicle. You should also consult the manufacturer of any equipment that has been added to your vehicle.

Posted Facilities

Turn your phone OFF in any facility where posted notices so require.

AIRCRAFT

FCC regulations prohibit using your phone while in the air. Switch OFF your phone before boarding an aircraft.

BLASTING AREAS

To avoid interfering with blasting operations, turn your phone OFF when in a "Blasting area" or in areas posted "Turn off two-way radio". Obey all signs and instructions.

POTENTIALLY EXPLOSIVE ATMOSPHERES

Turn your phone OFF when in any area with a potentially explosive atmosphere and obey all signs and instructions. Sparks in such areas could cause an explosion or fire resulting in bodily injury or even death.

Areas with a potentially explosive atmosphere are often, but not always marked clearly. Potential areas may include: fueling areas (such as gasoline stations); below deck on boats; fuel or chemical transfer or storage facilities; vehicles using liquefied petroleum gas (such as propane or butane); areas where the air contains chemicals or particles (such as grain, dust, or metal powders); and any other area where you would normally be advised to turn off your vehicle engine.

For Vehicles Equipped with an Air Bag

An air bag inflates with great force. DO NOT place objects, including either installed or portable wireless equipment, in the area over the air bag or in the air bag deployment area. If in-vehicle wireless equipment is improperly installed and the air bag inflates, serious injury could result.

SAR Information

THIS MODEL PHONE MEETS THE GOVERNMENT'S REQUIREMENTS FOR EXPOSURE TO RADIO WAVES.

Your wireless phone is a radio transmitter and receiver. It is designed and manufactured not to exceed the emission limits for exposure to radiofrequency (RF) energy set by the Federal Communications Commission of the U.S. Government. These limits are part of comprehensive guidelines and establish permitted levels of RF energy for the general population. The guidelines are based on standards that were developed by independent scientific organizations through periodic and thorough evaluation of scientific studies. The standards include a substantial safety margin designed to assure the safety of all persons, regardless of age and health.

The exposure standard for wireless mobile phones employs a unit of measurement known as the Specific Absorption Rate, or SAR. The SAR limit set by the FCC is 1.6 W/kg.* Tests for SAR are conducted with the phone transmitting at its highest certified power level in all tested frequency bands. Although the SAR is determined at the highest certified power level, the actual SAR level of the phone while operating can be well below the maximum value. This is because the phone is designed to operate at multiple power levels so as to use only the power required to reach the network. In general, the closer you are to a wireless base station antenna, the lower the power output.

Before a phone model is available for sale to the public, it must be tested and certified to the FCC that it does not exceed the limit established by the government-adopted requirement for safe exposure. The tests are performed in positions and locations (e.g., at the ear and worn on the body) as required by the FCC for each model. The highest SAR value for this model phone when tested for use at the ear is 1.48 W/kg and when worn on the body, as described in this user guide, is 1.22 W/kg. (Body-worn measurements differ among phone models, depending upon available accessories and FCC requirements). While there may be differences between the SAR levels of various phones and at various positions, they all meet the government requirement for safe exposure.

The FCC has granted an Equipment Authorization for this model phone with all reported SAR levels evaluated as in compliance with the FCC RF exposure guidelines. SAR information on this model phone is on file with the FCC and can be found under the Display Grant section of <http://www.fcc.gov/oet/fccid> after searching on FCC ID CJ6DCE42903A.

Additional information on Specific Absorption Rates (SAR) can be found on the Cellular Telecommunications & Internet Association (CTIA) web-site at <http://phonefacts.net>.

* In the United States and Canada, the SAR limit for mobile phones used by the public is 1.6 watts/kg (W/kg) averaged over one gram of tissue. The standard incorporates a substantial margin of safety to give additional protection for the public and to account for any variations in measurements.

SYSTEM CONFIGURATION

System configuration and the equipment list are as shown below.

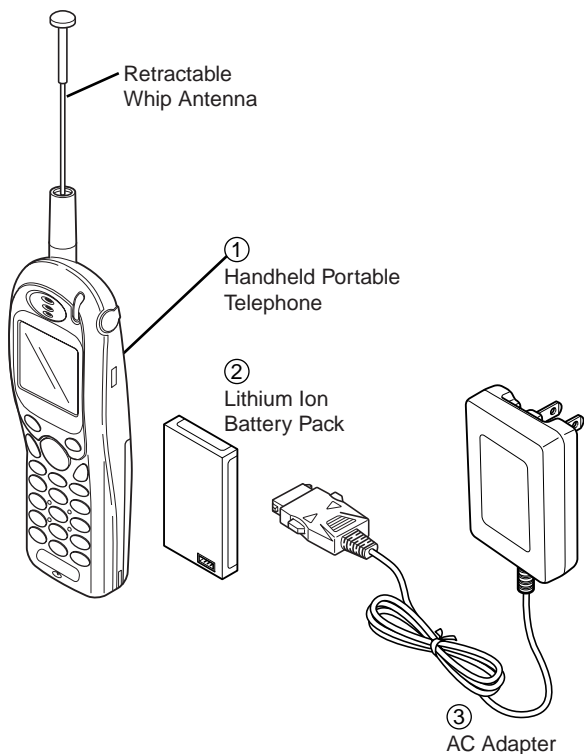

List of Equipment

No.	Name of the Equipment
①	Handheld Portable Telephone
②	Lithium Ion Battery Pack (BTR-9100)
③	AC Adapter (CNR-9100)

BATTERY INSTALLATION AND RECHARGING

To Attach the Battery Pack

1. Press and slide the battery cover to remove it.

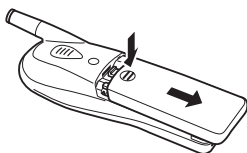

2. Place the BTR-9100 battery pack in the battery cavity so that it fits over the connector.

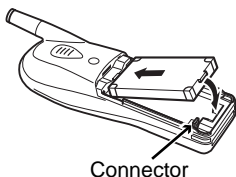

3. Slide the cover back to snap it on.

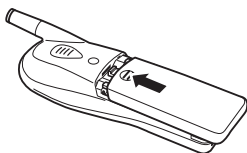

To Detach the Battery Pack

1. Press and hold  key to turn the phone off. Then press and slide the battery cover to remove it.

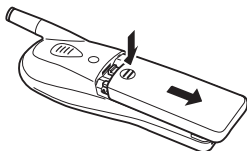

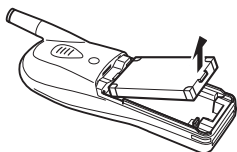

2. Lift the battery pack up to take it out.



To Recharge Battery

Your CDM-9100 phone has a built-in charger function. To recharge the Battery Pack, always install the Battery Pack to the phone.

1. Attach the BTR-9100 Battery Pack to the phone.
2. If the phone is on with the  indicator displayed, press and hold  to turn the phone off.
3. Insert the connector of the CNR-9100 AC Adapter to the phone connector.
4. Plug the AC Adapter to AC120V outlet.
5. Then the recharging starts. The phone displays **"Now Charging"** with animation and the  indicator scrolling. It also lights the Charging Indicator at the top of the phone.
6. When recharging is completed, the phone displays **"Fully Charged!"**.
7. Disconnect the AC Adapter from the outlet.
8. To disconnect the AC Adapter from the phone, hold the buttons to unlatch and pull the connector off.

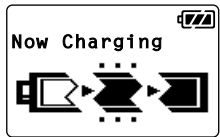

The recharging time, from empty to full, depends on the environmental temperature, 0 to +35 °C.

Battery Type	Recharging Time
Lithium Ion Battery Pack (BTR-9100)	1.5 to 2 h

- Notes:**
1. For complete recharging, it is recommended that the phone be turned off during recharging.
 2. It is normal for the battery to become a little warmer during recharging.
 3. Do not feed power to the phone without the battery pack attached.

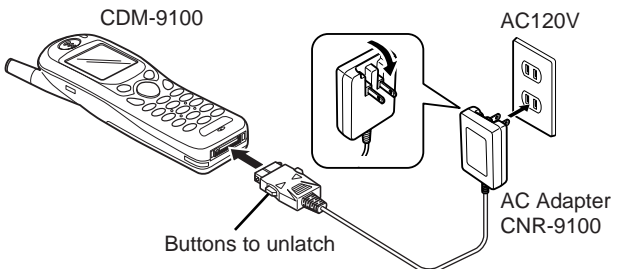

To Recharge with Desktop Holder

You can also recharge the phone using the CNR-9100 AC Adapter and the optional accessory DTH-9100 Desktop Holder as illustrated below.

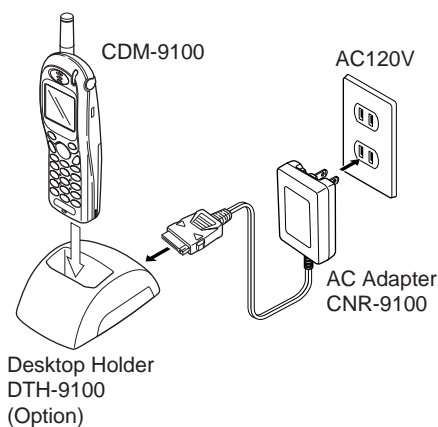

Battery Information

- Temperature extremes will affect the ability of your Battery Pack to charge; always allow it to cool down or warm up first. Never attempt to charge the Battery Pack if the ambient room temperature is below 32°F (0°C) or above 105°F (40°C).
- Subjecting the Battery Pack to extremely high or low temperatures will reduce its capacity and its life expectancy. Always try to keep the Battery Pack between 59°F and 77°F (15°C and 25°C), if possible.

FUNCTIONS

External View

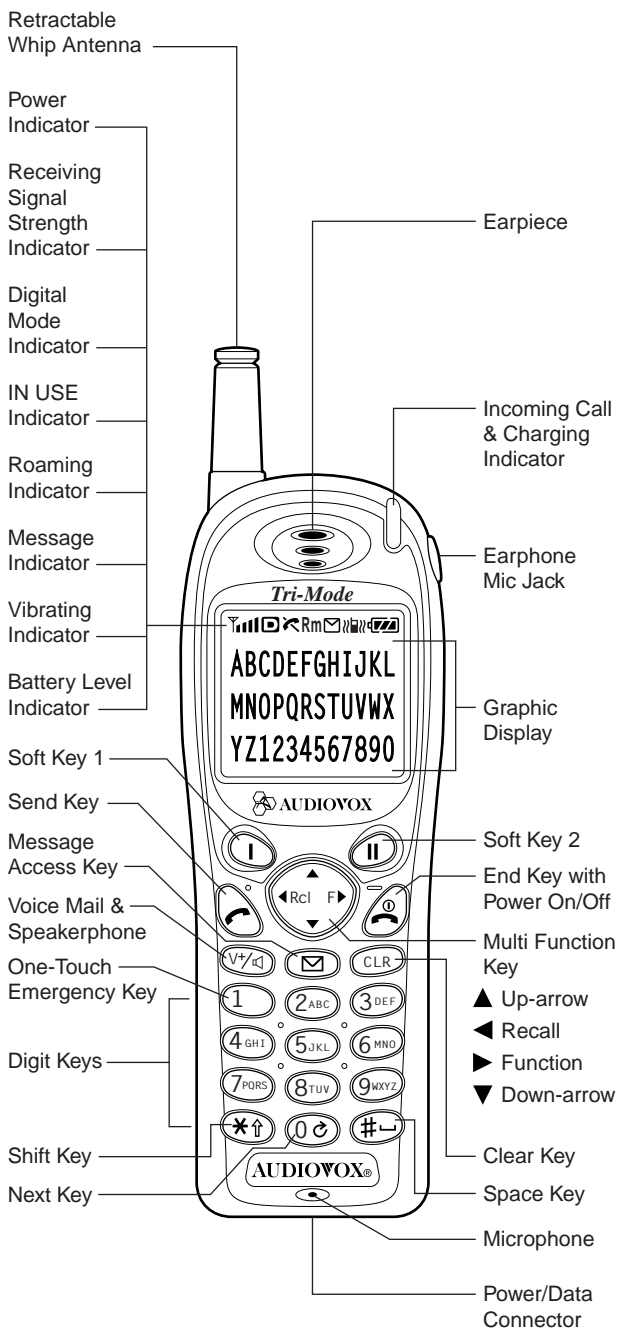

Function of Keys



Key-Board Arrangement	Digit Keys 		To enter Telephone Numbers. To enter letters and symbols (see page 32). 1 is also used for One-Touch Emergency feature.	
	Function Keys 			
			Soft keys. To function as shown in the bottom line on the display.	
		SEND key. To originate or receive a Call.		
		END key. To terminate a Call and to turn the phone ON/OFF.		
		To recall phone numbers from memory. Also used as Left-arrow key.		
		To be used with other keys to activate various special features. Also used as Right-arrow key.		
		To control the volume of Ringer, Key Tone and Earpiece/Speakerphone. Also used as Up/Down-arrow keys.		
		To access your Voice Mail with only one key (see page 60) and to activate Speakerphone mode (see page 29).		
		To review Text Messages or to learn how many Voice Messages are in your Voice Mailbox (see page 55).		
	To clear digits from the display or from a memory location.			

LCD Display Indication

Items	Descriptions
	Receiving Signal Strength Indicator. The number of lines indicates the received Signal Strength, and Y is also used as a POWER ON Indicator.
	Digital Mode Indicator. To indicate the phone is operating in digital mode.
	A Call is in progress.
	The phone is out of Service Area.
Rm	The phone is out of the Home Area.
	Message Indicator. To indicate that new Text Messages are stored in memory or new Voice Messages are in your Voice Mailbox.
	Vibrating Indicator. To indicate that the vibrating alert is active.
	Battery Level Indicator. Monitors the battery charge condition.
ABCDEFGHIJKL MNOPQRSTUVWXYZ YZ1234567890	Graphic full-dot matrix display with flexible font size in 3 to 7 lines.

GETTING STARTED

Turning the Phone On/Off

Press and hold . All the indicators and the display will light momentarily, and a tone will be heard. The indicator  will be displayed while the phone is turned on.

To turn the phone off, press and hold .

Antenna Position



The antenna can be used in its fully extended or fully retracted position only. It is recommended that the antenna should be fully extended for optimum performance and signal strength or while operating in poor signal areas.

Receiving Signal Strength Indicator ()

The number of lines indicates the Signal Strength in your area. Four lines show the maximum level. The display will vary as you move with the phone. If the signal is not strong enough to place a call, "" will appear on the LCD display.

Battery Level Indicator

You can always monitor the battery charge condition with the constant battery level indicator. The number of blocks indicates the battery conditions as follows:

-  Full charge
-  Low charge
-  Flashing indicates discharged.

Power Management

Battery	Mode	Talk Time up to	Standby Time up to
Lithium Ion (BTR-9100)	Digital	170 min.	170 h
	Analog	60 min.	15 h

The operating times are approximate values and may vary depending on network configuration and handset usage.

BASIC OPERATION

Placing Calls

To Place a Call

1. Enter the phone number.
(A maximum of 32 digits will be displayed.)



2. Press .
The indicator will light.

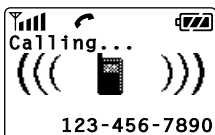

• To Correct a Number

Press to clear the last digit.

Press and hold to erase all the digits entered.

• If the Call Fails to Go Through

Press and to redial the number.

To Terminate a Call

Press . The indicator will go out.

Last Number Redial

1. Press the key under **Redial**, or press to recall the last number you dialed.

2. Press to redial it.

See **Call History** on page 52 for details. See also **Redial Soft Key (F04)** on page 89.

To Dial the Last Number Received

Press to recall the last number with Caller ID you received, then press .

See **Call History** on page 52 for details.

Phonebook Dialing



Press and enter an address (01 to 99) to recall a number from your phonebook, then press .

See **Phonebook Recall** on page 43 for details.

Tip: The key will be used for Voice Mail access.
See page 60.

Speed Dialing



If you know the phonebook address of the telephone number that you want to call, you may place a call without using .

1. Enter the one or two digits of your Phonebook address (1 to 9 or 10 to 99).
2. Press . The phone number will be displayed. The  indicator will light, and the call will be placed.

Note: If two telephone numbers are stored in the address, the Primary Number will be dialed.

Quick Dialing

When this feature is on, the Primary number in your Phonebook address 02 to 09 can be dialed with just one push of the key. See **Quick Dialing (F01)** on page 89 to turn this feature on/off.





1. Press a digit key ( to ) for more than one second.
2. The number in your phonebook is automatically dialed. The phone number will be displayed. The  indicator will light.

Note: The key  is not for Quick Dialing, but for **One-Touch Emergency Call**, page 27.

Emergency Call

This feature permits you to place an emergency call even if your telephone is in “**Phone Lock**”, “**Keypad Lock**” or “**Restrict**” mode. Up to 3 numbers can be programmed as Emergency numbers. The emergency numbers “**911**” and “***911**” are already preprogrammed. See **To Change Emergency Numbers (F62)** on page 84.

Example: To Call 911 in “**Phone Lock**” or “**Keypad Lock**” mode.

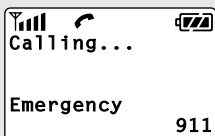

1. Enter   . The “**911**” will not be displayed.
2. Press .
The “**911**” will be displayed.
The  indicator will light, and the call will be placed.



One-Touch Emergency Call

This feature permits you to dial an emergency number by a single key stroke, even in the “**Phone Lock**” or “**Restrict**” mode. This feature can be turned off to prevent unintentional calls to the emergency number.

See **To Turn On/Off One-Touch Emergency Call Feature (F63)** on page 85.

1. Press and hold  for more than 2 seconds. The number in emergency memory location “1” will be dialed.
2. Then the  indicator will light, and the call will be placed. (The factory preset number is “911”.)

Note: This feature cannot be used if the Keypad Lock is on. You need to dial all the digits and .

Emergency Call Mode



When you dial one of the 3 preprogrammed emergency numbers, your phone will enter the **Emergency Call Mode**. In this mode, the phone will attempt to complete the emergency call using any available cellular system from which it can obtain service.

After it places an emergency call, the phone will stay in the **Emergency Call Mode**, and will display “**Emergency Call Mode, END to exit**”. In the **Emergency Call Mode**, the phone will attempt to continue to receive service from the Cellular system that it used to complete the call. The phone will automatically exit the **Emergency Call Mode** after 5 minutes or after you press .

Receiving Calls



The phone sounds an alert or vibrates to alert you of an incoming call. It also flashes the Incoming Call Indicator at the top of the phone.

To Receive a Call

When the telephone rings, press  to answer the call. The  indicator will light.

Note: To mute the ringer or stop the vibrating, press .

Any Key Answering

This feature permits you to answer an incoming call by pressing any key on the key pad except  and .

Caller ID with Name

This feature allows you to preview in your display the number and name of the party calling you before you answer the call. The name is as you programmed it in your phonebook.

1. When the phone rings, the Calling Number appears in the display.



2. The last 10 Caller IDs are stored in the memory for your review and redial. See **Call History** on page 52 for details.

Note: *"Number Restricted" or "Number Unavailable" is displayed when the Caller ID is restricted or not available.*

Automatic Calls-in-Absence Indicator

This feature indicates the number of unanswered incoming calls. The display indicates **"Called XX"**, the number of calls (01 to 99) you missed. It also indicates the caller number and name of the latest call, if available. Press the key under **Refer** to view **Incoming Call History**.

Depressing any key will clear the display. See **Redial Soft Key (F04)** on page 89.

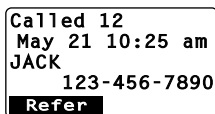

Ringtone with Melody



The CDM-9100 offers you 15 styles of ringer tones and melodies for alerting incoming calls. Ringer volume can also be adjusted. See **Ringer Type Selection (F32)** on page 74 and **Ringer Volume Control (F31)** on page 73 for setting. See also **Vibrating Alert (F8)** on page 88.

Distinctive Ringing (Audible Caller ID)

You may program different ringer styles for different phonebook addresses. See **To Store a Ringer Type with the Phone Number** on page 40 for setting.

During Calls





To Adjust the Earpiece Volume

Simply press  or  to adjust Earpiece/Speakerphone Volume during a call.



To Mute a Phone Conversation





There are two ways to mute the microphone during a call.

1. Press the key under **Mute**, or press  .
2. Then the screen displays "**Phone is muted!**".
3. To return to normal mode, press the key under **Unmute**, or press   again.

Note: *Terminating a call cancels the muting.*

Speakerphone Mode (One-Way)

This feature allows you to listen to the party or your voice mail through the built-in speaker, while the earpiece and microphone are muted.

1. To activate this feature, press  during a call. The screen displays "**Speaker ON!**".
2. Press  or  to adjust the earpiece/speakerphone volume.
3. To return to normal mode, press  again.

Note: *Terminating a call cancels the speakerphone mode.*

Automatic Talk Timer

The talk time of the current call will be automatically displayed. For example, "**1H 23M 45S**".

Scratch Pad Dialing

If you enter a telephone number during a call, the number will be stored in the Scratch Pad memory.



After terminating the call, the number you entered can be dialed by pressing .

Note: *You can deactivate "**Sending DTMF**" so that keypad tones will not be transmitted to the calling party. See **Sending DTMF (F34)** on page 74.*

Call Waiting



Your service provider may provide Call Waiting service. When you are on a call, you may hear a beep tone alerting you of another incoming call.

Your phone displays "**New Caller**" and the new caller's name and number. The name is as you programmed it in your phonebook.

1. Press  to answer the new call.
2. Press  again to switch between the two calls.

Three-Way Calling

Your service provider may provide Three-Way Calling service. When a call is already in progress, you may call the third party.

1. Enter a number and press  to call the third party.
2. Press  again to connect all three parties.

Ask your service provider for the detailed information.

Standby

Indicators on Standby

Your phone displays date and time, various settings status, and soft keys in standby.

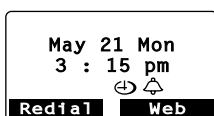

 : **Ringer Volume** is in **Silent** mode. See page 73.

 : **Automatic Answering** is active. See page 89.

 : **Phone Lock** is active. See page 70.

 : **Keypad Lock** is active. See page 69.

 : **Countdown Timer** is active. See page 79.



 : **Clock Alarm** is active. See page 78.

Redial : See **Last Number Redial** on page 25.

Web : See **Accessing Internet** on page 63.

Note: For displaying date and time, see **Clock Indicator (F42)** and **Clock Adjustment (F43)** on page 77.

Vibrating Alert

To activate Vibrating Alert, press and hold . To deactivate it, press and hold  again. See also **Vibrating Alert (F8)** on page 88.

Multilingual

Your phone provides multiple languages: English, Spanish, French and Portuguese for displaying the menus and prompts in the Basic Operation, Phonebook Operation and Function Menu. See **Language Selection (F24)** on page 72.

End to End Signaling

To utilize certain phone services, such as accessing an alternate long distance network, signaling a pager or banking by phone etc., Touch Tone™ signaling is required. The following features will make it easy to send frequently used Touch Tone™ signals. See **Link Dialing** on page 50 for more information.

Touch Tone™ from Display

When **Sending DTMF** (page 74) mode is on, the numbers will be sent in Touch Tone™ signals during a call as you press digit keys. When **Sending DTMF** mode is off, you can send Touch Tone™ signals in the following manner.

1. Enter the number.



2. Press  and scroll to "Tone".

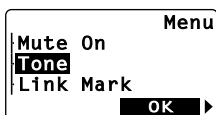



3. Press . The number in the display will be sent in Touch Tone™ signals.

Touch Tone™ from Memory

Touch Tone™ signals can be sent from memory during a call.

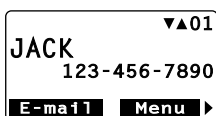
1. Press , and recall the number you want to send in Touch Tone™ signals.



2. Press  and scroll to "Tone".

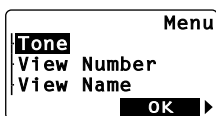

3. Press . The number in the display will be sent in Touch Tone™ signals.

Entering Letters and Symbols

The text entry mode **T9** or **Alpha** will automatically be active when necessary to enter letters, such as names or messages. The current mode is displayed as **T9** (T9) or **abc** (abc) at the bottom of the screen. Also numeric or symbol mode will appear by pressing the key under **T9** (T9) or **abc** (abc). Available modes depend on the feature that you use.

T9 Mode **T9** (T9)

The T9 mode allows you to enter text quickly by pressing one key per letter. This mode suggests English words as you type.



Example:

1. Type **4** ^{GHI} **6** ^{MNO}. Your phone displays **in**.
2. Press **0** [↻] to display the next choice **go**.
3. Press **#** [↵] to decide the word “go” and add a space.

The **Shift** key ***↑** turns letter cases: **T9** (normal), **T9↑** (initial cap.) and **T9⇧** (caps. lock).

The **Next** key **0** [↻] displays the next choice.

The **Space** key **#** [↵] decides a word and adds a space.

To decide a word, press **F** [▶].

To insert punctuation marks, press **1**.

To delete a character, press **CLR**.

To delete a word, press and hold **CLR**.

To move the cursor, press **←Rcl** or **F** [▶].

To enter digits, press and hold the key **0** [↻] to **9** ^{WXYZ}.

Note: For more information, visit www.T9.com.

Alpha Mode **abc** (abc)

The Alpha mode allows you to enter characters by pressing the digit key repeatedly. For example, press **5** ^{JKL} once to enter “J”, or press **5** ^{JKL} three times to enter “L”.

The **Shift** key ***↑** turns letter cases: **abc** (normal), **Abc↑** (initial cap.) and **ABC⇧** (caps. lock).

The **Space** key **#** [↵] adds a space.

To decide a character, press **F** [▶].

To delete a character, press **CLR**.

To delete a word, press and hold **CLR**.

To move the cursor, press **←Rcl** or **F** [▶].

To enter digits, press and hold the key **0** [↻] to **9** ^{WXYZ}.

Assigned Alpha Characters in Alpha Mode

Key	English	Spanish
1	1 @ / - : ' ? . , () ;	
2 ^{ABC}	A B C 2	A Á B C 2
3 ^{DEF}	D E F 3	D E É F 3
4 ^{GHI}	G H I 4	G H I Í 4
5 ^{JKL}	J K L 5	J K L 5
6 ^{MNO}	M N O 6	M N Ñ O Ó 6
7 ^{PQRS}	P Q R S 7	P Q R S 7
8 ^{TUV}	T U V 8	T U Ü Ú V 8
9 ^{WXYZ}	W X Y Z 9	W X Y Z 9
0	0	0

Key	French	Portuguese
1	1 @ / - : ' ? . , () ;	
2 ^{ABC}	A À Â B C Ç 2	A À Á Ã B C Ç 2
3 ^{DEF}	D E Ë È É Ê F 3	D E É Ê F 3
4 ^{GHI}	G H I Ï Î 4	G H I Í 4
5 ^{JKL}	J K L 5	J K L 5
6 ^{MNO}	M N O Ô 6	M N O Ó Ô Õ 6
7 ^{PQRS}	P Q R S 7	P Q R S 7
8 ^{TUV}	T U Ù Û V 8	T U Ü Ú V 8
9 ^{WXYZ}	W X Y Z 9	W X Y Z 9
0	0	0

Note: Available languages in the Alpha mode depend on the feature that you use.

Numeric Mode **Num** (Num)

To enter digits, press the digit key (0) to (9^{WXYZ}).

To delete a digit, press (CLR).

Symbol Mode **Sym** (Sym1 to 4)

The symbol mode appears in two ways depending on the feature that you use.

All Symbols on One Screen

Move the cursor with (←Rcl F→) to select one of symbols on the screen. Press the key under **OK** to select it and return to the previous mode.

Symbols on Multi-Screen (Web Browser)

Scroll the screens **Sym1**, **Sym2**, **Sym3** and **Sym4** with (↑) or (↓). Press the digit key ((1) to (9^{WXYZ})) to select a symbol and return to the previous mode.

Shortcut: Press and hold the key under **T9** or **abc** to turn to **Sym**. (except Web Browser)

PHONEBOOK OPERATION

Your phone has an Enhanced Phonebook with 99 dual-number memory addresses. At each address, you can store up to two telephone numbers under one name. This feature allows you to store, under one name, a person's home and office number, office and mobile number, etc. Stored numbers can be easily recalled and dialed by pressing . An e-mail address can also be stored at each memory address. Numbers can also be marked Secret for added privacy.

Phonebook Entry

Basic Sequence

To program your phonebook, enter the information in the following order. You may skip "name", "e-mail address" and/or "option".

1. Enter **phone number(s)**.

See page 35 and 37.



123-456-7890
STO Menu ▶

2. Enter **name**. See page 38.

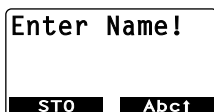

Enter Name!
STO Abct

3. Enter **e-mail address**.

See page 39.

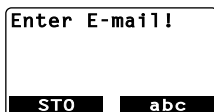

Enter E-mail!
STO abc

4. Enter **option**. See page 39, 40 and 49.

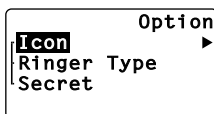

Option ▶
Icon
Ringer Type
Secret

5. Enter **phonebook address**.



See page 35.













Address: __
Auto: 01
STO Option ▶

Note: When shifted from **Text Messages**, the sequence changes as: phone number, e-mail address, name, option and address. You may skip "phone number", "name" and/or "option".

To Store a Number without Name

1. Press  or press and hold  to clear the screen, then enter the phone number (up to 32 digits).
2. Press the key under **STO** three times, then enter the desired memory address (01 through 99).

Example: To store the phone number 1 2 3 4 5 6 7 8 9 0 in address 07.

1. Press and hold .
2. Enter    
    
.



123-456-7890
STO **Menu** ▶

3. Press the key under **STO** three times.

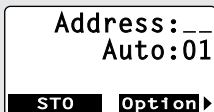

Address: __
Auto: 01
STO **Option** ▶

4. Enter an address  .

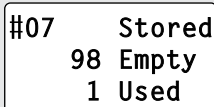











#07 Stored
 98 Empty
 1 Used

Automatic Storing into Phonebook

This feature allows convenient automatic storing into a vacant phonebook address. The number will be stored in the first available memory address which will be indicated in the display. This feature can prevent the possible overwriting of a previously stored number.

1. Enter the phone number.
2. Press the key under **STO** four times.

Example: To store the phone number 1 2 3 4 5 6 7 8 9 0 into a vacant memory address 01.

1. Press and hold .
2. Enter    
    
.



123-456-7890
STO **Menu** ▶

3. Press the key under **STO** three times.

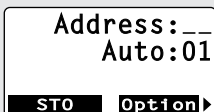

Address: __
Auto: 01
STO **Option** ▶

4. Press the key under **STO**.

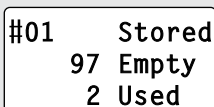

#01 Stored
 97 Empty
 2 Used

Auto Hyphenation

With this feature on, hyphens are automatically inserted when you enter telephone numbers and when you recall the numbers from the phonebook. See **Auto Hyphenation (F23)** on page 72 to activate or deactivate this feature.

Length of Number	Display Example
10 digits or less	123-456-7890
11 to 21 digits	1-234-567-89012
22 digits or more	No hyphens

Note: When you manually insert hyphens, the “Auto Hyphenation” feature will not work for that particular number.

Manual Hyphenation

You can manually insert a hyphen at any place when you enter a telephone number. The maximum number is 32 digits long including hyphens.

Example: To insert a hyphen in the number 1 2 3 4 5 6 7 to display it as 123-4567.

1. Enter (1) (2 ABC) (3 DEF) .



2. Press (F) and scroll to “Manual Hyphen”.

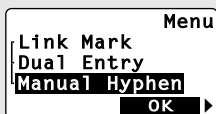

3. Press (F) .

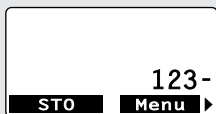

4. Enter (4 GHI) (5 JKL) (6 MNO) (7 PQRS) .



Tip: The screen may display dual prompts such as **Menu** ►. This means that pressing the (F) key operates the same as pressing the key under **Menu** .

To Store Dual Numbers in Phonebook

You can store Dual Numbers with Dual Mark “\” up to 40 digits for the address 01 to 90, and up to 80 digits for the address 91 to 99 in the phonebook.

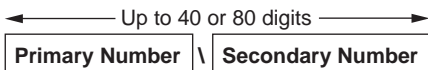

To store two telephone numbers in one phonebook address, enter the first number, select the Dual Mark “\” by using the menu, then enter the second number.

Example: To store the primary number 1 2 3 4 5 6 7 8 9 0 and the secondary number 9 8 7 6 5 4 3 2 1 0 in address 08.

1. Enter **1** **2** **3** **4** **5** **6** **7** **8** **9** **0**.

123-456-7890
STO **Menu**

2. Press **F** and scroll to “Dual Entry”.

Menu
 Link Mark
Dual Entry
 Manual Hyphen
OK

3. Press **F**.
 The Dual Mark “\” is inserted.

Primary
 1
 23-456-7890\
STO **Menu**

4. Enter **9** **8** **7** **6** **5** **4** **3** **2** **1** **0**.

Secondary
 987-654-3210
STO **Menu**

5. Press the key under **STO** three times.

Address: __
 Auto: 02
STO **Option**

6. Enter an address **0** **8**.

#08 Stored
 96 Empty
 3 Used

Note: You can add a second number after storing a first number. See **To Enter a Second Number** on page 46.

To Store a Name with the Phone Number

To use this procedure, you will need to refer to “**Entering Letters and Symbols**” on page 32.

1. Enter the phone number.
2. Press the key under **STO**.
3. Enter the name.
4. Press the key under **STO** twice, then enter the memory address (01 through 99) to store the number with the name into memory.

Example: To store the phone number 1 2 3 4 5 6 7 8 9 0 with the name Jill into memory address 11.

1. Enter the phone number;



2. Press the key under **STO**.

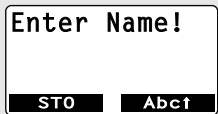

3. Enter the Name;

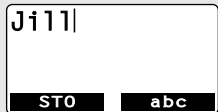
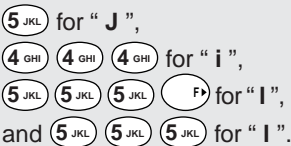

4. Press the key under **STO** twice.



5. Enter an address 1 1.

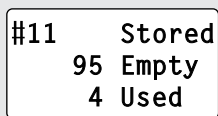

Note: To enter names into the phonebook in the Alpha mode you can use the alphabet that you selected with **Language Selection (F24)** on page 72.

To Store E-mail Address

You can store an e-mail address up to 48 characters long with phone numbers in your phonebook.

Example:

1. Enter a phone number and press the key under **STO** twice. Enter e-mail address.

Enter E-mail!
STO abc

2. Press the key under **STO**.

Address: __
Auto:02
STO Option▶

3. Press the key under **STO** to store it.

Note: To add an e-mail address after storing numbers, see “**Modify**” menu on page 46.

To Mark Numbers with Icon

You can mark every number with an icon among 9 options under the “**Option**” menu before storing.

Example:



1. Enter phone number(s) and e-mail address.

Address: __
Auto:03
STO Option▶

2. Press the key under **Option**.

3. Press  and scroll to a number to be marked.

Icon
 123-456-7890
 987-654-3210
 abcde@audiovo
OK Select▶

4. Press  and scroll icons with .

Icon
[Home] [Grid] [Phone] [Phone] [Phone]
[Phone] [Phone] [Phone] [Phone] [Phone]
Set

5. Press the key under **Set**.

Icon
 123-456-7890
 987-654-3210
 abcde@audiovo
OK Select▶

6. Repeat steps 3 through 5 for other numbers.
7. Press the key under **OK** to return to step 1 for other options.

Note: To add icons after storing numbers, see “**Modify**” menu on page 46.

To Store a Ringer Type with the Phone Number (Distinctive Ringing)

You can choose one of 15 ringer types for each phonebook number. With this feature, you will be able to distinguish who is calling by hearing the ringing tone. The ringer type is selected under the “**Option**” menu before storing.

Example:

1. Enter phone number(s), and press the key under **STO** three times.

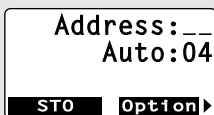

2. Press **F** and scroll to “**Ringer Type**”.

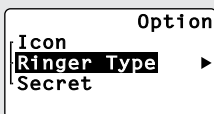

3. Press **F** and scroll to one of the numbers you want to set.

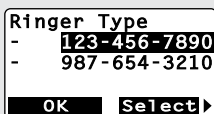

4. Press **F** and scroll to sample the different ringer types.

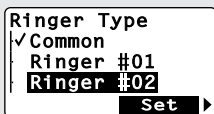

5. Press **F** to set the new ringer type.

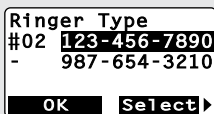

6. Press the key under **OK**.

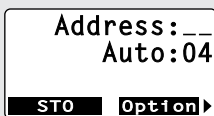

7. Press the key under **STO**.

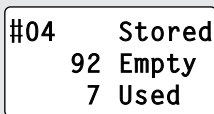

Note: The “**Common**” shown in the step 4 is the ringer type you selected with the Function Menu. See **Ringer Type Selection (F32)** on page 74.

Overwrite Warning

When you attempt to store a number in an address where another number has already been stored, the “**Overwrite**” warning will appear on the screen.

Example: To store the number 9 8 7 6 5 4 3 2 1 0 in the address 07, where another number 1 2 3 4 5 6 7 8 9 0 is already stored.

1. Enter **9**WXYZ **8**TUV **7**PQRS **6**MNO
5JKL **4**GHI **3**DEF **2**ABC **1**
0↺.

987-654-3210
STO Menu ▶

2. Press the key under **STO** three times.

Address: __
Auto: 05
STO Option ▶

3. Enter **0**↺ **7**PQRS.
The already stored number is displayed momentarily.

123-456-7890
#07 is used.

4. Two seconds later.

Overwrite?
Yes
No
OK ▶

5. If you accept to overwrite, scroll to “**Yes**” and press **F**▶.

6. If you do not want to overwrite, scroll to “**No**” and press **F**▶. The screen returns to the step 2 again.

Recall Menu

Press . The following “Recall” menu will prompt you to recall the number from memory.

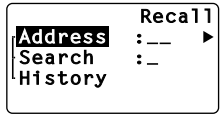

- “Address”: Phonebook Address Mode
- “Search”: Phonebook Sort Scroll Mode or Phonebook Key Word Search Mode
- “History”: Call History Mode

Recall Menu Tree

Main Menu Sub-menu

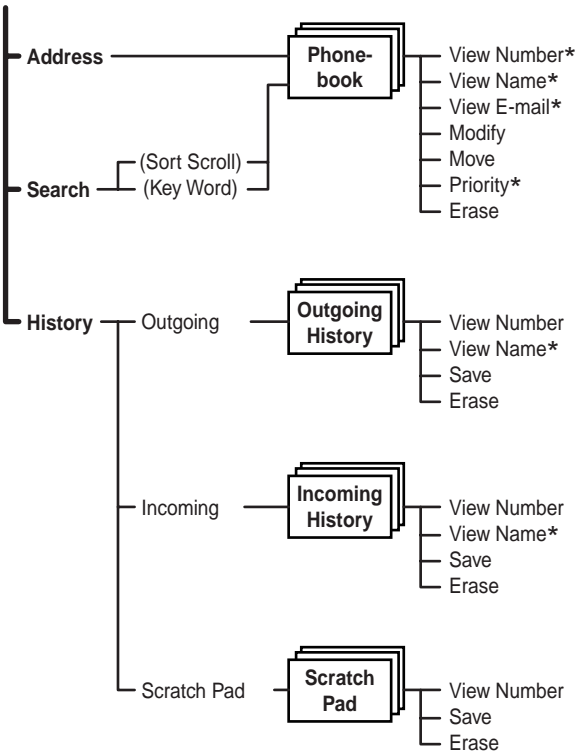

Note: The sub-menus marked with * will be available on the screen, if the corresponding items are stored in that address.

Phonebook Recall

To recall the numbers stored in your phonebook, you have three methods: Address Mode, Sort Scroll Mode and Key Word Search Mode.

Phonebook Address Mode

This mode is useful in finding a phone number by recalling a specific address or by scrolling the phonebook.

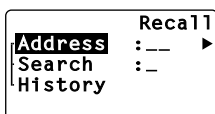

1. Press .
2. Enter the two-digit Memory Address.

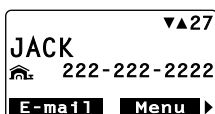

3. The phone number is displayed.

Example:



4. Press  or  to scroll.

Note: The scroll feature will skip any vacant memory address(es).

Phonebook Sort Scroll Mode

This mode sorts and displays, in alphabetical order, telephone numbers stored with “Alpha Tags” (Names). Blank digits on top will be disregarded for scroll.

Example: To display the numbers stored in the memory alphabetically from “J”.

1. Press  and press  and press  for “J”.



2. Press .



3. Press .

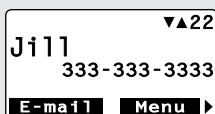

4. Press .

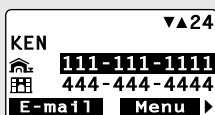

Phonebook Key Word Search Mode

This mode searches and displays the character string of Alpha Tags stored in the phonebook. Any part of the Alpha Tag can be used for the search.

Example: To search the character string AN stored in the phonebook.

1. Press  and press  and press  for "A".

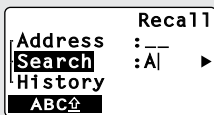

2. Press   for "N".

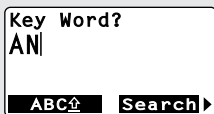

3. Press .



4. Press .

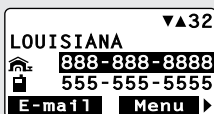

5. Press  .

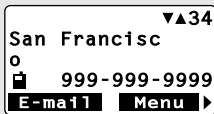

6. Press .



7. Press .

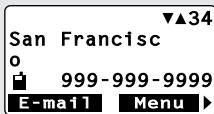



Note: The key word can be searched regardless of upper or lower case letters.

Tip: In all three recall modes, long names and phone numbers are displayed in the short form as necessary: a name in the first 12 characters and a number in the last 12 digits.

To Dial Dual Numbers

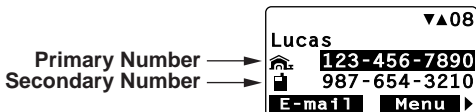

After the number is recalled in the display, it can be easily called by pressing .

- To dial the primary number, just press .
- To dial the secondary number, press  .







To Review Long Names and Numbers

This feature allows you to review whole Alpha Name Tags or long numbers stored in your phonebook.

1. Use any of the previously described phonebook search modes to recall a number.
2. Press  and scroll to “View Number” or “View Name”. Press  again.

To Review E-mail Address

1. Use any of the previously described phonebook search modes to recall a number.
2. Press the key under **E-mail**.
3. Press  or  to scroll e-mail addresses.
4. To view long e-mail address, press  and scroll to “View E-mail”. Press  again.



Prepending Dialing

This feature will be convenient when you need to add an area code to the number in the phonebook.

Example: To add 1 2 3 to a number 4 5 6 7 8 9 0.

1. Recall the number.



2. Enter   .

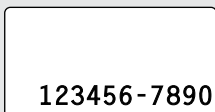

3. Press . Then the call is placed to 123-4567890.

Note: The added digits will not be stored in the phonebook memory.

Phonebook Edit

This section guides you on how to modify, move, change priority and erase the phonebook contents.

To Modify Numbers and Names

You can modify any of the phonebook contents you have stored, including Phone Numbers, Names, E-mail Addresses, Icons, Ringer Types, Secret and Phonebook Addresses.

To Modify Phone Numbers

Recall the number from the phonebook.

Press **F▶** to select “**Menu**”, then scroll to “**Modify**” and press **F▶**. Enter the new digit(s) and delete the old digit(s) by pressing **CLR**.

To Modify Alpha Name Tag

Recall the number and proceed to “**Modify**” as above. Press the key under **STO**, and the Name Tag will appear by itself. Press **CLR** to clear the letter(s), and enter the new Name.

To Modify Phonebook Address

After you modified number/name, just press the key under **STO** without entering new address, and the current phonebook address will be overwritten. If you enter a new address, the modified number/name will be copied to the new address, while the original address will remain unchanged.

To Enter a Second Number

Example:

1. Recall the number stored in the memory address.

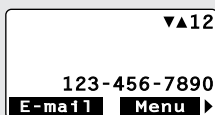

2. Press **F▶** and scroll to “**Modify**”.

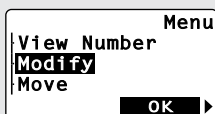

3. Press **F▶**.



4. Press the key under **Menu** and scroll to “Dual Entry”.

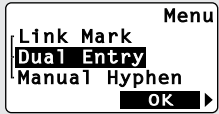

5. Press **F▶**.
The Dual Mark “\” is inserted.

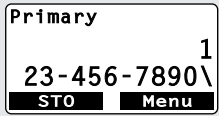

6. Enter the second number.

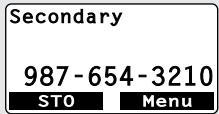

7. Press the key under **STO** three times.

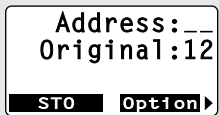

8. Press the key under **STO** to store in the original address.

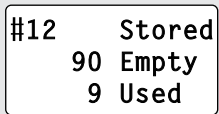

To Move Numbers and Names

You can move the phonebook contents to a new address. The original address will then be erased.

Example:

1. Recall the number stored in the address 20.

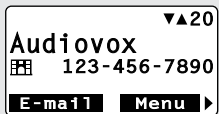

2. Press **F▶** and scroll to “Move”.

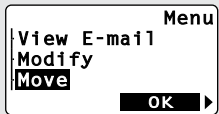

3. Press **F▶**.



4. Enter a new address **1** **5_{JKL}**.

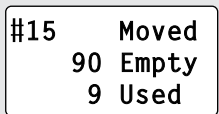

To Change Priority of Dual Numbers

You can interchange the primary and the secondary numbers in a phonebook address. The submenu “**Priority**” will only be available when two telephone numbers are stored in that address.

Example:

1. Recall the number.

Primary Number →
Secondary Number →

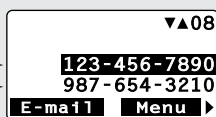

2. Press and scroll to “**Priority**”.

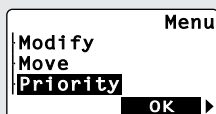

3. Press .

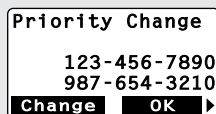

4. Press the key under **Change**. The new priority is displayed.

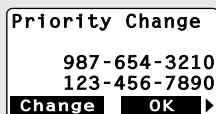

5. Press to decide it.

Note: The primary number will be dialed when you use **Speed Dialing** and **Quick Dialing** features.

To Erase Numbers and Names

This feature erases the number already stored in the phonebook.

Example:

1. Recall the number.

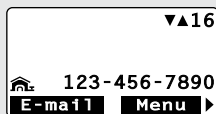

2. Press and scroll to “**Erase**”.



3. Press . The number is shown again.

4. Two seconds later the screen is changed.

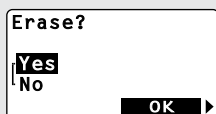

5. To erase the number scroll to “**Yes**”, otherwise “**No**”, and press .

Secret Memory

To Store a Secret Number

This feature permits you to store a phone number or e-mail address that you want to keep secret in your phonebook. The secret number can be accessed only by entering the **Security Code** (see page 69).

Example: To store the phone number 1 2 3 4 5 6 7 8 9 0 in address 30 as a secret number.

1. Enter **1** **2**_{ABC} **3**_{DEF} **4**_{GHI} **5**_{JKL} **6**_{MNO} **7**_{PQRS} **8**_{TUV} **9**_{WXYZ} **0** .

123-456-7890
STO **Menu** ▶

2. Press the key under **STO** three times.

Address: __
Auto: 10
STO **Option** ▶

3. Press  and scroll to "Secret".

Option
Icon
Ringer Type
Secret ▶

4. Press . Scroll to a number to be secret for two numbers or more.

Secret
123-456-7890
OK **On/Off** ▶

5. Press . The number turns "Secret".

Secret
Secret
OK **On/Off** ▶

6. Press the key under **OK**.

Address: __
Auto: 10
STO **Option** ▶

7. Enter an address **3**_{DEF} **0** .

#30 Stored
80 Empty
19 Used

Note: Each of the phone numbers and e-mail address can be marked secret by repeating step 4 and 5.

To Recall a Secret Number

Example: To recall the number 1 2 3 4 5 6 7 8 9 0 stored in the address 30.

1. Use Phonebook Search Mode to recall a secret number.



2. Press .



3. Enter the four-digit security code and press .

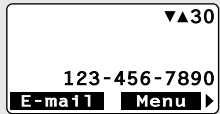

Link Dialing



This feature permits you to link groups of numbers to be sent in sequence. The linked numbers can be stored in memory. When dialed, the first group of numbers will be sent in digital signaling, and the rest of the numbers will be sent in Touch Tone™ group by group each time you press .

To Store Linked Numbers in Phonebook

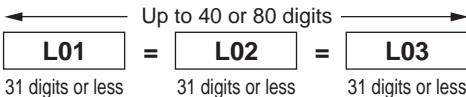
You can store Linked Numbers with Link Marks “=” up to 40 digits for the address 01 to 90, and up to 80 digits for the address 91 to 99 in the phonebook.



The example on the next page shows how to store a Linked number at a specific memory address.

1. Enter the first number.
2. Press  . A link mark “=” will be added at the end of the number.
3. Enter the second number. If you wish to link additional number(s), return to 2.
4. Press the key under **STO** three times, then enter the memory address (01 to 99).

Example: To link 3 numbers and store in Address 35.

1. Enter the first number.



2. Press .

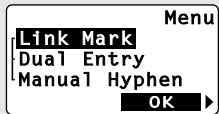

3. Press .

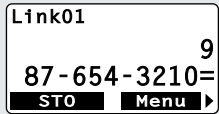

4. Enter the second number.



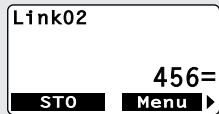

5. Press  .



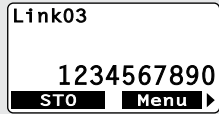

6. Enter the third number.



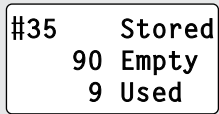



7. Press the key under **STO** three times. Enter an address  .



Note: While entering a linked number, you may review all the parts of that number, even those already entered.

Press , scroll to "**View Number**" and press . The linked numbers you have just entered will be displayed one by one each time you press .

To Place Calls Using Linked Numbers

1. Press , and select the linked number you want to call. (See **Phonebook Recall** on page 43.)
2. Press . Then the  indicator will light as the first number is dialed.
3. Press . The second linked number will be sent in Touch Tone™ signals. Succeeding numbers can be sent sequentially by pressing  again.

Call History

This feature recalls outgoing Call History and incoming Caller ID numbers. This is convenient for redialing recently called numbers or for returning missed calls by using the stored Caller ID. (See **Caller ID with Name** on page 28.)

Call History Memories

Memory	Description
Outgoing	Last 10 numbers you dialed. Address 01 to 10.
Incoming	Last 10 numbers you answered or missed. Address 01 to 10.
Scratch Pad	Last 3 numbers you wrote during calls. Address 01 to 03.

You can access the memory in two ways, Scroll and Shortcut.

By Scrolling

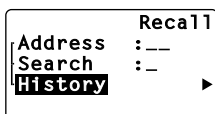

1. Press  and scroll to "History".



2. Press  and scroll to the menu item you want.









3. Press  to select.

4. To review the numbers in memory, scroll with  or .

5. After a number is displayed, it can be easily dialed, by simply pressing .

Shortcut:

- Press    to display the latest number in the outgoing history memory.
- Press    to display the latest number in the incoming history memory.



To Review Outgoing Call History

Example: To recall a number from Outgoing History.

1. Press  .

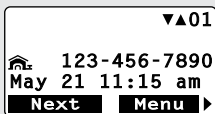
The most recent call is displayed.



2. Scroll with  or  to review other numbers.
3. You can place a call by simply pressing .

When duplicate numbers are called, only the latest call is stored in the outgoing call history memory.

To Review Incoming Call History

Example: To recall a received Caller ID from Memory Stack.

1. Press  .

The most recent call is displayed.

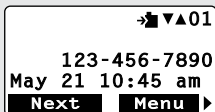

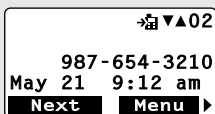

2. Press .





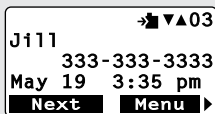

3. Press .

A name is shown, if available in your phonebook.





4. You can place a call by simply pressing .



In the incoming call history, the calls are marked with  or . Numbers with  represent calls you missed, and numbers with  represent calls that you answered. When duplicate numbers are received, only the latest call is stored in the incoming call history memory.

To Review Scratch Pad

Example:

1. Press  and scroll to "History".
2. Press  and scroll to "Scratch Pad".
3. Press .



4. Scroll with  or  to review other numbers.
5. You can place a call by simply pressing .

To Save a Number to Phonebook

The numbers in the Call History and Scratch Pad Memory can be stored in your phonebook. You can add a name in the same way as "Modify". See **To Modify Numbers and Names** on page 46.

Example: To save a received Caller ID to phonebook.

1. Recall a number.

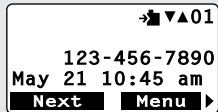

2. Press  and scroll to "Save".

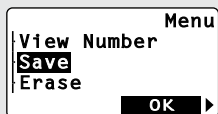

3. Press .



4. Press the key under **STO** three times.

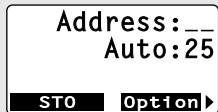

5. Enter   as an address.

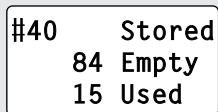





MESSAGING FEATURES

Your CDM-9100 Audiovox Cellular Telephone features Two-way Short Message Service (SMS) that sends and receives Text Messages through your phone. The phone also supports Voice Mail Notification.

Please note that operation of these features depends on the Cellular System and therefore may not be available in all areas. To inquire about availability or to subscribe to these services, please contact your service provider.

Message Indicator

A message indicator  displays the current state of received messages at the upper right of the screen.

 Flashing	You have new "urgent" Text Messages or new "urgent" Voice Mail Notification.
 Steady	You have new Text Messages or new Voice Mail Notification.
 off	Neither new Text Message nor new Voice Mail Notification.

Message Menu

The "Message" main menu appears by pressing .

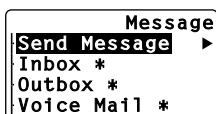

- **Send Message:** To create and send message.
- **Inbox:** To check the received messages.
- **Outbox:** To review the messages that you sent.
- **Voice Mail:** To view Voice Mail Notification.
- **Settings:** To customize the messaging features.
- **Address Entry:** To shift to the phonebook mode for entering e-mail address.

- Notes:**
1. A mark " * " flashes, when new messages are available in the Inbox or Voice Mail respectively.
 2. A mark " * " flashes, when draft messages remain unsent in the Outbox.
 3. Shortcut to Inbox: Press and hold  to open "Inbox".

Receiving Text Messages

Your phone is able to receive and display a text message of up to 255 characters. The phone saves up to 30 messages in your Inbox.

When your phone receives a new text message, the  indicator is displayed. The screen displays "New Message" with animation. Depending on the settings, the phone may also sound a short beep tone.





To Check Received Messages

1. Press and hold  to open "Inbox".
2. The **Inbox** lists the received messages with sender name or number.

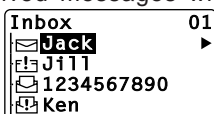
Example:



3. Scroll the list, and press .
4. The screen displays the time stamp, sender, call-back number if available, and message, each time you press .
5. To view Inbox Option, press the key under **Option**.
6. To return to the list, press the key under **OK**.

Notes: 1. The sender name is as you programmed it in your phonebook.

2. The icons mean as follows:

 : **New text** that you have not viewed yet.

 : **Old text** that you have already viewed.

 : **Urgent, new text**

 : **Urgent, old text**

3. To dial a callback number, press the key under **Send** when the number appears.



Inbox Option

- **Reply:** To shift to **Send Message** mode for replying to the message. Note this feature may not be available at all locations.
- **Forward:** To shift to **Send Message** mode for forwarding the received message.
- **Erase:** To erase the received message.
- **Save Address:** To save the sender address, call-back number or the both in your phonebook.

Sending Text Messages

While operating in the digital mode, your phone is able to send a text message of up to 5 recipients with a cellular phone number or e-mail address. The phone saves up to 30 messages in your Outbox.

To Send a Text Message

1. Press  and  to enter "Send Message" menu. The "Send To" appears.

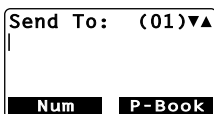

2. Enter the cellular phone number or e-mail address. You can also recall it from your phonebook by pressing the key under **P-Book**.

3. Press the key under **OK**. Then "Enter Text" appears. Enter your message.

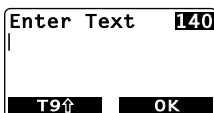



4. Press the key under **OK**. The menu appears for editing your message.

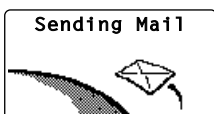

5. To send the message, press  or the key under **Send** while the **D** indicator is on.

6. Then "Sending Mail" appears with animation. Depending on the settings, the message may be saved in the Outbox.





- Notes:**
1. To specify two or more recipients, press  after step 2, and repeat the same step.
 2. You can create your message in English or in French that you selected with **Language Selection (F24)** on page 72.
 3. T9 mode is available for English only. See **Entering Letters and Symbols** on page 32.
 4. The message length is up to 140 characters that includes the text message and the e-mail address. It may be shorter depending on your service provider.
 5. If attempted in the analog mode, your message is saved to the Outbox without sending.
 6. If an incoming call interrupts your message, it will be saved to the Outbox.

Send-Message Menu

- **Edit Send To:** To correct address.
- **Edit Text:** To correct your message.
- **Priority:** To mark “**Urgent**” to your message.
- **Call Back # :** To change your call back number temporarily for your current message.
- **Delivery Ack:** To change acknowledgment mode temporarily for your current message. This feature is network dependent, and may not be available in all areas.
- **Save to Outbox:** To save your message as a draft and exit from the messaging feature.



Note: See also **Default Call Back #** and **Default Delivery Ack** under **Messaging Feature Settings** on page 61.

To Review Sent Messages

1. Press , scroll to “**Outbox**”, and press .
2. The **Outbox** lists the messages that you have sent.

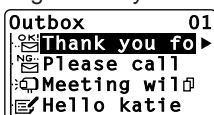



Example:



3. Scroll the list, and press .
4. The screen displays the time stamp, recipient, call-back number if available, and message, each time you press .
5. To view Outbox Option, press the key under **Option**.
6. To return to the list, press the key under **OK**.

Notes: 1. The list shows the first 12 characters per message.

2. The icons mean as follows:

-  : Message **sent** already
-  : Message **failed** to send
-  : Message **delivered** successfully
-  : Message **saved** as draft
-  : For two or more recipients.

Outbox Option

- **Edit:** To shift to **Send Message** mode for editing the message.
- **Resend:** To re-send the message to the same address while the  indicator is on.
- **Erase:** To erase the message.

Voice Mail

In order to use voice mail, you must first activate your voice mailbox. For information on how to do this, please contact your service provider.

Voice Mail Notification

The voice mail system sends a notification to your phone when new messages are left in your voice mailbox.

Normal Voice Mail Notification

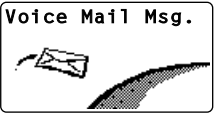

Your phone notifies you when new messages are in your voice mailbox.

1. The  indicator is displayed. The screen displays “**Voice Mail Msg.**” with animation. Depending on the settings, the phone may also sound a short beep tone. 
2. To learn how many messages are in your voice mailbox, see **To Display Number of Voice Mail Messages** on the following page.
3. To listen to your voice mail messages, see **Voice Mail Dialing** on the following page.

Voice Mail Notification with Mail Retrieval Service (MRS)

1. The screen displays “**Message Retrieval**”. Depending on the settings, the phone may also sound a short beep tone.
2. Press  to answer the incoming call, your phone will be connected to your Voice Message Service so that you may retrieve your messages.
3. If you choose not to answer the incoming call, “**Message Retrieval**” will be stored in the stack for retrieval of your messages at a later time.

To Display Number of Voice Mail Messages

1. Press , scroll to "Voice Mail", and press .
2. The screen displays the number of messages in your voice mailbox.

Example:

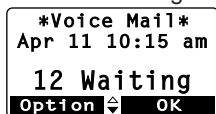

3. Press  to view additional information.
4. To erase the voice mail notification, press the key under **Option** and select "Erase".

Voice Mail Dialing



You can store one set of linked numbers in a specially provided memory, and access these numbers with one touch of the "Voice Mail Access" key .

To Store the Voice Mail Access Number







Please see **To Store Linked Numbers in Phonebook** on page 50, and follow the steps 1 through 3 to make a set of linked numbers. Press the key under **STO** three times, and press  to store.

Up to 80 digits of linked numbers can be stored including link mark "=". You can also add a Name Tag (up to 24 characters) with your voice mail number. (See **To Store a Name with the Phone Number** on page 38.)

To Call Your Voice Mail

1. Press and hold . The first number will be displayed and dialed.
2. Press . The second number will be displayed and sent in Touch Tone™ signal.
3. The succeeding numbers can be sent sequentially by pressing .

To Review the Voice Mail Access Number

1. Press  to select the Phonebook Address Mode.
2. Press   . The first linked number in  will be displayed.
3. Press  (one or more times) to display the remaining linked numbers in .

Messaging Feature Settings

The following menu allows you to customize your phone's Text Messages and Voice Mail Notification features.





Default Call Back

Enter your callback number as default that will be added to all sending text messages. Your own phone number has been preset to the callback number for your convenience. To change it for an individual message, see **Send-Message Menu** on page 58.

Default Delivery Ack

For sending your text message, you can request a delivery acknowledgment that the recipient receives the message. This feature is network dependent, and may not be available in all areas.

Select one of the following modes as default. To change it for an individual message, see **Send-Message Menu** on page 58.

- **Enhanced Ack:** When the acknowledgment is received, the phone displays “**Delivered!**” with the time stamp and recipient, and it also turns the icon  (sent) into  (delivered) in the Outbox.
- **Normal Ack:** When the acknowledgment is received, the phone turns the icon  (sent) into  (delivered) in the Outbox.
- **No Ack:** No acknowledgment is requested.

Note: The “**Delivered!**” is displayed for the messages that have been saved in the Outbox.

New Message Alert

This feature alerts you when a new text message is received. Select one of the settings below.

- **Alert On:** Short beep tone sounds once.
- **Alert Off:** Alert does not sound.
- **Vibrate Only:** Vibrating alert only.
- **Reminder:** Short beep tone sounds at every 2 minutes while animation is displayed.

Voice Mail Alert

This feature alerts you when a new voice mail notification is received. Select one of the settings below.

- **Alert On:** Short beep tone sounds once.
- **Alert Off:** Alert does not sound.
- **Vibrate Only:** Vibrating alert only.
- **Reminder:** Short beep tone sounds at every 2 minutes while animation is displayed.

Text Entry Mode

This feature allows you to select a text entry mode that appears first for entering your message.

- **T9 Mode:** “T9” appears first, then, “**Abc**”, “**Num**” and “**Sym**”.
- **Alpha Mode:** “**Abc**” appears first, then, “T9”, “**Num**” and “**Sym**”.

Save Sent Message

This feature allows you to select whether to save messages that you sent.

- **Auto Save:** All messages are saved in the Outbox.
- **Prompt:** The phone prompts you to choose it for every message.
- **Do not Save:** No message is saved.

Erase All Text Messages

This feature erases all text messages saved in the Inbox or Outbox.

SMS Text Lines Selection

You can select to have the text messages displayed in 4 or 6 lines for the Inbox and Outbox.

SMS Memory Management

This feature allows you to select Inbox memory management.

- **Auto Delete:** If the Inbox is full, it deletes the oldest text message to save a new text message.
- **Warning Msg.:** If the Inbox is full, it does not save any new text message, displaying “**Memory Full, New Text Rejected**”.

Note: *The Outbox functions always in **Auto Delete** mode.*

WEB BROWSING

Your CDM-9100 Audiovox Cellular Telephone allows you to enjoy accessing various Internet websites directly from your phone, including news, sports, travel, and weather, if you subscribe to Internet service with your service provider. Your phone also supports network services such as e-mailing with the web browser. Please contact your service provider for details of the available services.





Accessing Internet

Your phone is able to access the Internet while it operates in the digital mode, as indicated by the  indicator.

To Start Web Browser







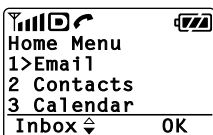

1. Press the key under **Web** on standby to enter “Web Menu”.



2. Scroll to “Internet”, and press .
3. The Web Browser will start. The cached information may be displayed.
4. To access the Internet, press and hold  while  indicator is on. Your phone will display your service provider's home page with a flashing .

Example:



5. Scroll the page by  or .
6. Press  or  to select the menu option in the bottom line of the display.
7. To return to the previous page, press  or .
8. To terminate the network access, press . The  indicator will go out. You can still browse the cached information.
9. Press  again to close the web browser.



Browser Menu

Press **(V+/Q)** key while the browser is active to see the browser's local menu. This menu is displayed in English or French.

Browser Menu	
1>	Reload
2	Home
3	Bookmarks
Back	⇅
	OK

1. **Reload:** To reload the current page.
2. **Home:** To get back to the Home page. Press and hold **(CLR)** will do the same.
3. **Bookmarks:** To view your bookmark list.
4. **Mark Site:** To store the current page in your bookmark list.
5. **About Openwave:** To view the browser version.
6. **Advanced:**
 - **Show URL:** To display the URL (Uniform Resource Locator) of the current page.
 - **Homepage:** To change your home page.
 - **Set WAP Proxy:** To select a network server.
 - **Restart Browser:** To clear the cache memory in your browser.
 - **Encryption:** To use for security.

Note: *Altering of the settings on the "Homepage" and "Set WAP Proxy" may disable the web access.*

E-mailing with Browser

The Web Browser allows you to send and receive e-mails directly through your phone. Please contact your service provider for details of the service.

To Send and Receive E-mails

1. Follow the step 1 to 4 on **To Start Web Browser** to access your service provider's home page.
2. Follow the e-mail instruction that may be available at your service provider.

Notes:

1. *You can create your message in English or in French that you selected with **Language Selection (F24)** on page 72.*
2. *T9 mode is available for English only. See **Entering Letters and Symbols** on page 32.*
3. *The message length is up to 512 characters to send. It may be shorter depending on your service provider.*

Net Alert with Browser

The Web Browser is able to receive an alert for a message from your service provider. This is called a Net Alert.

To Receive Net Alert

1. When a Net Alert is received, the web browser starts automatically and notifies you on the screen.

Example:

Message from UP.link. View it now?	
Skip	View

2. Press the key under “**View**” for accessing your service provider’s home page to view the message.
3. If you select “**Skip**”, the alert is saved in Alert Inbox for later checking.

To Check Alert Inbox

When your Alert Inbox saves alerts, the screen turns **Web** into **Web** at its bottom. It saves up to 9 alerts.

1. Press the key under **Web** to enter “**Web Menu**”.
2. Press **F** to open “**Alert Inbox**”.

Example:

Alert Inbox	
1>XXXX	
2 XXXX	
Erase	View

3. Press the key under “**View**” for accessing your service provider’s home page to view the message.

Web Browser Settings

Your cellular telephone is already programmed for Internet service that may be available from your Service Provider. You can customize your browser with the following four menus only.

Web Lock

You can lock the unauthorized access to the Internet. If the browser is locked by this feature, you will need to enter your 4 digit Security Code to access the web.

Web Backlight

You can turn on/off the backlight setting during the web access. Select the menu: “**30sec.**” (5s to 99sec), “**Off**” or “**Always On**”.

Web Idle Timer

If there is no network activity within a specific time, the web access call is automatically terminated. Set the timer between “**0min.01sec.**” and “**9min.59sec.**” To deactivate this feature, set the timer to “**0min.00sec.**”

Confirm — Connect Prompt

You can turn on/off a prompt “**Set up Connection?**” for accessing the Internet.

Connection Settings

You should not use the following menus under “**Connection**” to change any settings in the phone, unless otherwise instructed by your carrier. Altering any of these settings may disable the Web access capability.

Your phone can have up to 4 sets of the server IP (Internet Protocol) addresses and Port numbers to access your service provider’s website. These may already be preset or be advised by your service provider.

To change the settings, enter your 4-digit Security Code.

To Change IP addresses in “Web Link A”

1. Scroll to “**Web Link A**” and press **F>**.
2. Enter **Link A Primary IP Address** and press **F>**.
3. Enter **Link A Primary Port number** and press **F>**.
4. Enter **Link A Secondary IP Address** and press **F>**.
5. Enter **Link A Secondary Port number** and press **F>**.

To Change IP addresses in “Web Link B”

Scroll to “**Web Link B**” and press **F>**, and follow the above steps 2 through 5 for **Link B**.

Notes: 1. An IP address must be 12-digit long to enter. If you have, for example, 123.45.67.8,

then enter **1** **2**ABC **3**DEF, **0** **4**GHI **5**JKL, **0** **6**MNO **7**PQRS, **0** **0** **8**TUV.

2. Your phone may display the stored IP addresses or Port numbers in the above steps. Then press **F>** to keep them unchanged.

Username & Password

The “**Username**” and “**Password**” are normally blank. Should anything be entered here, unless instructed by your Carrier, your cellular telephone may not be able to connect to the Web service.

Current Link

This is normally set to “**Web Link A**”. Altering to “**Web Link B**” may disable the Web access.

FUNCTION MENU



To Access Function Menu

Various phone settings can be changed through the Function Menu to customize your phone's functions to fit your convenience. See **Function Menu Tree** on the following page. You can reach the Function you want to access in two ways; Scroll and Shortcut.

By Scrolling

1. Press  to enter Main Menu.





2. Scroll with  or  key to the desired item in the Main Menu.

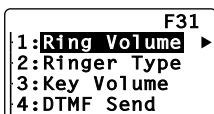

3. Press  to enter the submenu.



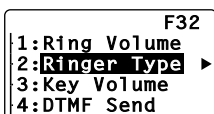

4. Scroll with  or  key to the desired item in the submenu.





5. Press  to enter the function.



By Shortcut

Each Function has its shortcut number for direct access. For example, to enter the function "Ringer Type" (F32), press   .

To Exit from Function Menu

- To return from a submenu to the main menu, press .
- To exit from Function Menu, press .

Notes:

1. A mark "▶" at the right in a menu prompt you that you can see its detailed items by pressing .
2. A mark "✓" shows the current setting of the function.
3. The screen may display dual prompts such as **OK ▶**. This means that pressing the  key operates the same as pressing the key under **OK**.

Function Menu Tree

Main Menu Submenu Branch

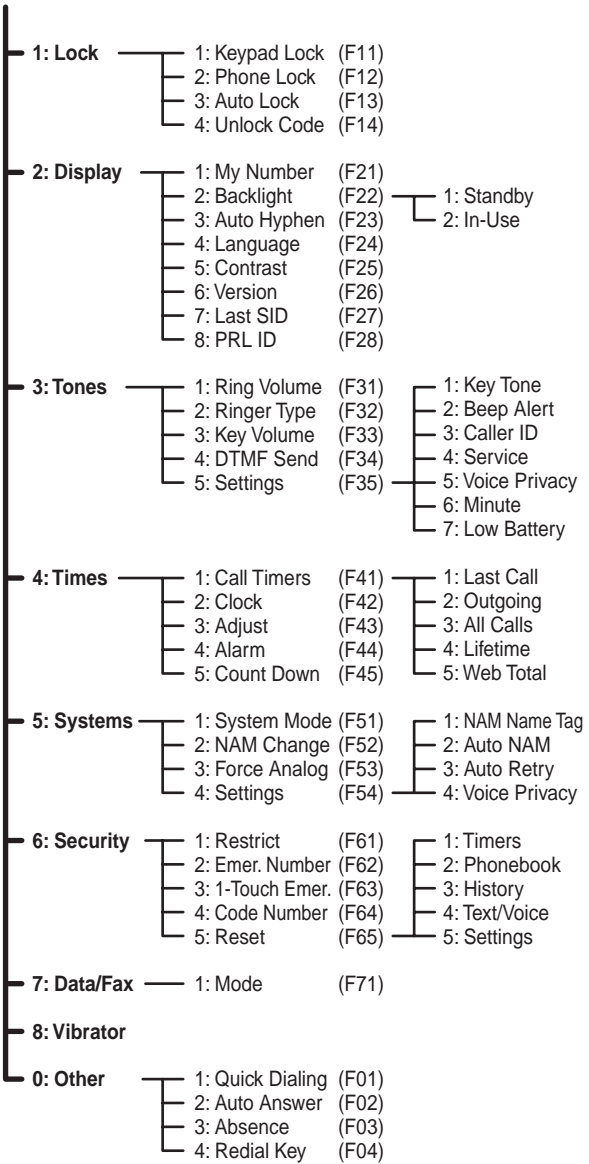

Lock Features

Security Code and Unlock Code

Your phone is equipped with the Security Code and the Unlock Code to access various security features. You may change the preset codes for added protection.

Code	Preset	Description
Security Code	1234	To access Secret Number, to set Call Restriction, etc.
Unlock Code	1234	To unlock the Phone

When “**Security Code:**” is displayed, you need to enter your four-digit security code.

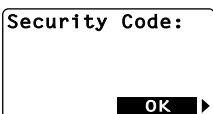



See **To Change the Security Code (F64)** on page 85.
See **To Change the Unlock Code (F14)** on page 70.

Keypad Lock (F11)

This mode is useful for preventing inadvertent pressing of keys. (For example, when the phone is in a purse or pocket.)

With this feature on, the following functions are still available.

- Incoming calls can be answered with .
- Muting the ringer or stopping the vibrating with .
- Programmed emergency numbers can be called. (Except for **One-Touch Emergency Call.**)

When this feature is on, the following functions are not available.

- Automatic Answering
- Any Key Answering
- One-Touch Emergency Call
- Quick Dialing
- Turning off the phone by .

To Activate/Deactivate this Feature:

1. Press    to activate “**Keypad Lock**” mode.

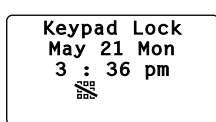



Keypad Lock
May 21 Mon
3 : 36 pm

2. Press    again to deactivate.

Phone Lock (F12)

This mode is useful to prevent unauthorized use of the phone. With this feature on, the following functions are still available.

- Incoming calls can be answered with .
- Muting the ringer or stopping the vibrating with .
- Any Key Answering
- Programmed Emergency Call
- One-Touch Emergency Call
- Turning off the phone by .

The following functions are not available when this feature is on.

- Automatic Answering
- Quick Dialing

To Activate:



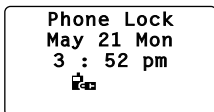



1. Press    to activate "Phone Lock" mode.



Note: The phone will remain locked even if the power is turned off.

Automatic Phone Lock (F13)

If you activate this feature, the phone will automatically go into the phone lock condition after it is turned off. (See **Phone Lock (F12)** above.) When you turn the phone on, you must enter the four-digit unlock code before it operates. (See **To Unlock the Phone** below.)





1. Press   .
2. You can turn this feature on/off by  or .
3. Press  to set.



To Unlock the Phone

1. Enter the four-digit unlock code.
2. The "Phone Lock" indicator will go out.

To Change the Unlock Code (F14)



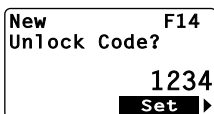

1. Press   .
2. Enter the four-digit security code and press .
3. The current unlock code will be displayed.
4. Enter a new four-digit unlock code and press .



Display Features

Own Telephone Number Display (F21)

This feature enables you to display your own telephone number and the ID number (SID) of your "Home" Cellular System.

1. Press   .
2. Press  to exit.

```
My Number      F21
(SIDH)         00020

123-456-7890
  OK ▶
```

Backlight Control (Standby) (F22-1)

The LCD display and keypad are backlit automatically after Power-On.



The backlighting duration can be changed. Three modes are available.

1. Press   .



```
Backlight      F221
Control
1: Standby ▶
2: In-Use
```

2. Press .

```
Backlight      F221
Standby
✓ 10sec. ▶
Off
Always On
```

3. You can change the current mode by  or .
4. Press  to set.

- **10 Seconds Mode**

Backlight is on for 10 seconds after a key is pressed. It also lights automatically when the power is turned on and for an incoming call. To change the duration, press , enter a value (5 to 30 seconds) and press  again.

- **Off Mode**

Backlight is on momentarily when the power is first turned on, but remains off thereafter.

- **Always On Mode**

Backlight is always on.





Note: You can keep the backlight on while you are engaged in a conversation. See **Backlight Control (In-Use) (F22-2)** on page 72.

Backlight Control (In-Use) (F22-2)

For ease of operation, you may select to have the backlight always on while you are engaged in a conversation. When this feature is set to the “Always On” mode, the backlight is turned on as long as the call is connected.

1. Press   , and scroll to “In-Use”.



2. Press .
3. Scroll with  or  to “Normal” or “Always On”.
4. Press  to set.

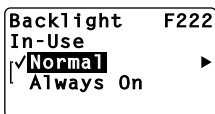



Auto Hyphenation (F23)

See **Auto Hyphenation** on page 36.

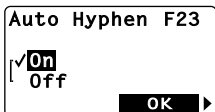
1. Press   .





2. Scroll with  or  to “On” or “Off”.
3. Press  to set.

Language Selection (F24)

This feature allows you to select the language the menus and prompts are displayed in. There are four options: English, Spanish, French, and Portuguese.

1. Press   .





2. Scroll with  or  to the desired language.
3. Press  to set.

Contrast Control (F25)

The LCD display contrast can be adjusted in 7 steps to suit your taste.

1. Press   .



2. Adjust the contrast with  or .
3. Press  to set.

Software Version Review (F26)

This feature permits you to review the software version which is installed in your phone.

1. Press .

2. Press to exit.

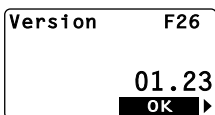

Last Rescan SID Indicator (F27)

This menu item permits you to view the **System Identification Number (SID)**, which your phone is currently using.

1. Press .

2. Press to exit.

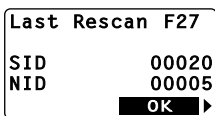

PRL ID Review (F28)

This menu item permits you to view the **Preferred Roaming List (PRL)** version that is programmed in your phone.

1. Press .

2. Press to exit.

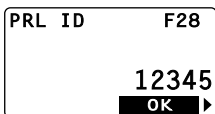

Volume and Tone Controls

Ringer Volume Control (F31)

This feature allows you to adjust the ringer/melody volume. The following adjustment will also change the volume of the **Clock Alarm** alert and the **Countdown Timer** alert.

1. Press .



2. Keep pressing or until you get the desired sound level, or **"Silent"** mode.



Note: In **Silent** alert mode, ringer tone is not given for an incoming call. However, if Automatic Answering feature is ON, ringer tone is given with the lowest available volume.

Ringer Type Selection (F32)

This feature permits you to select a ringer tone pattern from 15 options including melody ringers.

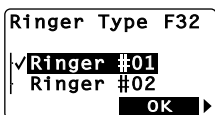
1. Press   .





2. Press  or  to select the ringer tone.
3. Press  to set.

Key Tone Volume Control (F33)

1. Press   .







2. Keep pressing  or  until you achieve the desired sound level, or "Silent" mode.

Note: Key tone will be off in **Silent** mode, but tone will be heard on the other side of the line.

Sending DTMF (F34)

This feature allows you to activate or deactivate Sending DTMF (Touch Tone™) when you enter a number during a call.

1. Press   .
2. Scroll to "On" or "Off" to select.
3. Press  to set.

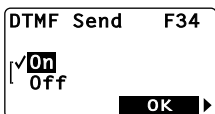



Key Tone Length (F35-1)

This feature selects the duration of the tone length when a key is pressed.

1. Press    and .



2. You can change the current mode by  or .
3. Press  to set.

- **Normal Mode**

Tone is heard as long as the key is being pressed.

- **Short Mode**

Tone is heard for a short time even if the key remains pressed.

Single Alert Beep Tone (F35-2)

This feature is used to signal an incoming call with only a single beep. This feature can only be used with the **Silent** alert mode. See **Ringer Volume Control (F31)** on page 73.

1. Press **F**, **3** and **5** and **2**.

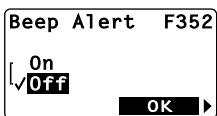

2. You can turn this feature on/off by **▲** or **▼**.
3. Press **F** to set.

Caller ID Alert (F35-3)

This feature audibly alerts you when a Caller ID is received.

1. Press **F**, **3** and **5** and **3**.

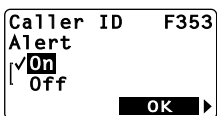

2. You can turn this feature on/off by **▲** or **▼**.
3. Press **F** to set.

Service Mode Alert (F35-4)

With this feature on, an audible tone alerts you when the service mode changes from Digital to Analog, or vice versa.

1. Press **F**, **3** and **5** and **4**.



2. You can turn this feature on/off by **▲** or **▼**.
3. Press **F** to set.

Voice Privacy Alert (F35-5)

This feature audibly alerts you when the voice privacy service is provided, and also when the service is canceled.

1. Press **F**, **3** and **5** and **5**.



2. You can turn this feature on/off by **▲** or **▼**.
3. Press **F** to set.

One Minute Beep Tone (F35-6)

With this feature on, you will be notified during a call, once every minute by a short beep tone. In addition, two beep tones will sound every five minutes.

1. Press **F**, **3** DEF, **5** JKL and **6** MNO.



2. You can turn this feature on/off by **▲** or **▼**.
3. Press **F** to set.

Low Battery Alarm (F35-7)

When activated, this feature sounds an audible alarm when the battery level is low.

If the alarm is given, recharge the battery pack or replace it with a fully charged battery pack.

1. Press **F**, **3** DEF, **5** JKL and **7** PQRS.



2. You can turn this feature on/off by **▲** or **▼**.
3. Press **F** to set.

Call Timers

To help you manage your calls, your phone is equipped with several Call Timers.

Last Call Timer (F41-1)

1. Press **F**, **4** GHI, **1**.
The talk time of the last call will be displayed.
2. Press **F** to exit.

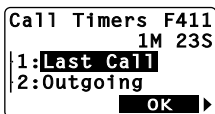

Outgoing Call Timer (F41-2)

1. Press **F**, **4** GHI, **1** and **2** ABC. The cumulative talk time of all outgoing calls will be displayed. Web access call will not be added in this timer.
2. Press **F** to exit.

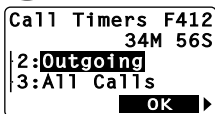

All Calls Timer (F41-3)

1. Press **F**, **4** (GHI), **1** and **3** (DEF). The cumulative talk time of all incoming and outgoing calls will be displayed. Web access call will not be added in this timer.



```
Call Timers F413
      1H 23M 45S
3: All Calls
4: Lifetime
      OK
```

2. Press **F** to exit.

Note: The above three timers can be reset to zero by using **Call Timer Reset (F65-1)** on page 85.

Lifetime Timer (F41-4)

1. Press **F**, **4** (GHI), **1** and **4** (GHI). The cumulative “lifetime” talk time of all incoming and outgoing calls will be displayed.

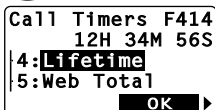

```
Call Timers F414
      12H 34M 56S
4: Lifetime
5: Web Total
      OK
```

This timer cannot be reset to zero.

2. Press **F** to exit.

Web Total Timer (F41-5)

1. Press **F**, **4** (GHI), **1** and **5** (JKL). The cumulative time of web access call will be displayed.

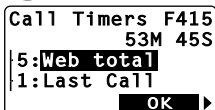

```
Call Timers F415
      53M 45S
5: Web total
1: Last Call
      OK
```

2. Press **F** to exit.

Note: This timer can be reset to zero by using **Call Timer Reset (F65-1)** on page 85.

Clock Indicator (F42)

Date and Time are automatically displayed, if this feature is enabled.

1. Press **F**, **4** (GHI), **2** (ABC).
2. You can turn this feature on/off by **▲** or **▼**.
3. Press **F** to set.



```
Clock Indicator F42
[✓] On
  Off
      OK
```

Clock Adjustment (F43)

You can use your clock in **Auto** or **Manual** mode.

In **Auto** mode, your clock synchronizes to the base time of the CDMA system and displays the local time of the area where you are, while the **□** indicator is on.

In **Manual** mode, your clock always works alone, and can be adjusted manually.

Example: To set the time to 9:15 a.m. Apr. 21, 2001 in **Manual** mode.

1. Press .
2. Scroll to "**Manual**" and press .

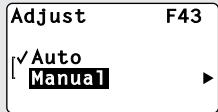

3. Enter the year , month , day , time and for a.m. (or for p.m.)

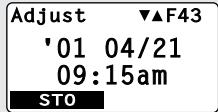

4. Press the key under **STO** to set.

- Notes:**
1. In step 3 above, you can correct a digit by or , moving the cursor by or .
 2. The clock works internally during power off, and will display the time in the same mode when you turn the power on.

Clock Alarm (F44)

This feature alerts you repeatedly at the alarm time you programmed.

Example: To set the alarm time to 7:30 a.m.

1. Press .
2. Scroll to "**On**" and press .

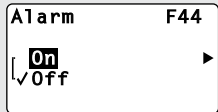

3. Enter the alarm time and for a.m. (or for p.m.)

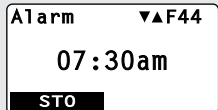

4. Press the key under **STO** to set. The indicator will be displayed.
5. At the alarm time, the alarm will ring for one minute with animation.
6. Press any key to stop ringing.
7. The clock alarm will repeat to ring every day until you cancel the feature.



- Notes:**
1. If the alarm is set to sound during a call, the clock alarm will ring after the call.

2. The clock alarm does not ring during power off, but this feature will be activated again when you turn the power on.
3. The clock alarm may not ring in **Auto** mode if you skip the alarm time traveling into an area with the different local time.
4. See **Ringer Volume Control (F31)** on page 73 to change the alarm sound volume.
5. In place of the alarm sound, you can use **Vibrating Alert (F8)** on page 88.

Countdown Timer (F45)

This feature alerts you when the countdown timer expires. The timer can be set to 1 through 99 minutes.

To Start the Countdown Timer

1. Press **F4** (**4** GHI) **F5** (**5** JKL).
2. Enter the duration, 1 to 99 minutes.
3. Press **F4** to start. The **⏻** indicator will be displayed.
4. When the timer expires, the alarm will ring for one minute with animation.
5. Press any key to stop ringing.

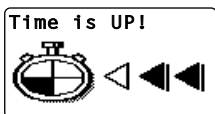
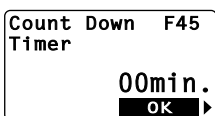

To Cancel the Countdown Timer

1. Press **F4** (**4** GHI) **F5** (**5** JKL) again after the timer has started.
2. "Count Down Stop?" is displayed with the remaining minutes to expire.
3. Scroll to "Yes" and press **F4** to cancel. The **⏻** indicator will go out.

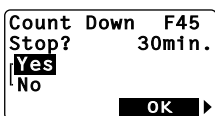

- Notes:**
1. If the timer expires during a call, the alarm will ring after the call.
 2. When you turn the power off, the countdown timer will be canceled.
 3. See **Ringer Volume Control (F31)** on page 73 to change the alarm sound volume.
 4. In place of the alarm sound, you can use **Vibrating Alert (F8)** on page 88.

System Features

System Mode Selection (F51)

This feature permits you to select which Cellular system your phone uses.

Leave this setting as it has been preprogrammed unless you have a reason to alter the system selection.

To alter the system selection:

1. Press **F** **5** **1**. The current mode will be displayed.

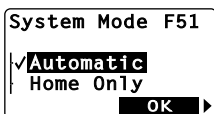

2. You can change the current mode by **▲** or **▼**.
3. Press **F** to set.

- **Automatic**

The phone will scan the priority systems first, and then non-priority systems. For more information as to how this mode works, see **Enhanced Roaming** below.

- **Home Only**

You can place or receive calls only within your home area or home affiliated area.

- **Analog Only**

The phone will scan the Analog systems only. The phone will return to the original mode, **Automatic** or **Home Only**, when the power is turned on next time.

Enhanced Roaming

Cellular systems are identified by a number called System Identifier or SID. Your phone is equipped with a **Preferred Roaming List (PRL)** which can be programmed by your Carrier to take advantage of the families of cellular system (SIDs) that your Carrier owns, or has special billing arrangements with, in different cities.

In your Home System Area, both "R" and "Rm" are not displayed on your phone. Outside of the Home System in Service Areas closely associated with your Carrier, the phone's display may appear the same as when operating in the Home System.

In areas where your Carrier has Roaming agreements, your phone will display a steady "Rm" indication. If your display indicates a flashing "Rm", you are in a cellular system which is not associated with your Carrier (you can still make or receive calls).

If your display indicates a flashing "↶", you may have to change your System Mode Selection or NAM Selection in order to obtain service. If your display indicates "↶", you are in an area where there is no cellular service.

NAM Selection (F52)

Some Cellular users may find it beneficial to register their phones with multiple numbers, for different cities where they may frequently travel. To provide this ability, your phone has two NAMs (Number Assignment Modules) enabling up to two registrations.

If you have multiple registrations, the NAM Selection feature enables you to change the NAM being used by your phone. Do not use this feature, if you do not have multiple registrations.

To change NAMs:

1. Press **F▶** **5** JKL **2** ABC.
2. You can change the current NAM by **▲** or **▼**.
3. Press **F▶** to set.

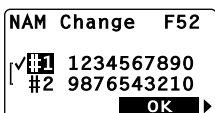

Force Analog Call (F53)

This feature temporarily directs the phone to use the Analog Mode even if the Digital Mode has been previously selected.

1. Press **F▶** **5** JKL **3** DEF.
2. Press **F▶** when scanning the Analog Mode.



Notes: This feature automatically ends if:

- 1) The phone is turned off.
- 2) An outgoing call is made.
- 3) An incoming call is received.
- 4) After 10 minutes if items 1) ~ 3) did not occur.

NAM Name Display (F54-1)

You can program a greeting or a name of a maximum 12 characters on your LCD display. This will be displayed when the phone is turned on or when you change the NAM. (See **NAM Selection (F52)** on page 81.) As you can program a different name for each NAM, you can tell which NAM is currently active when you turn the phone on.

1. Press **F** **5** **4** and **1**.

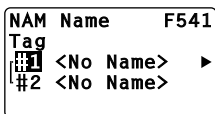

2. You can select other NAM by **▲** or **▼**. Then press **F** to edit.

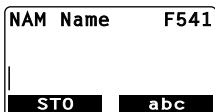

3. Enter your message.

(See **Entering Letters and Symbols** on page 32.)

4. Press the key under **STO** to store the message.

Automatic NAM (F54-2)

If you have multiple NAM registrations (see previous description), your phone will recognize NAMs for which you are registered. The phone will then automatically switch to the proper NAM for the area in which you are in.

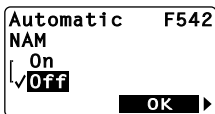

1. Press **F** **5** **4** and **2**.



2. You can turn this feature on/off by **▲** or **▼**.
3. Press **F** to set.

Automatic Retry (F54-3)

With this feature on, your telephone will automatically make up to seven call attempts when the first try is not successful.

The  indicator will stay on, and the speaker will be muted. Press  to cancel the Automatic Retry.

1. Press **F** **5** **4** and **3**.







2. You can turn this feature on/off by **▲** or **▼**.
3. Press **F** to set.







Enhanced Voice Privacy Service (F54-4) (Digital Mode Only)

This feature requests the cellular system to provide the enhanced voice privacy service. This service can only be provided in the Digital Mode, and its availability depends on the cellular system and your service provider.

To Set the Enhanced Voice Privacy Mode:

1. Press    and .



2. To request the cellular system to provide the enhanced voice privacy service, select "Enhanced" with  or , and press .
3. When the phone is operating in the Enhanced Voice Privacy Mode, "VP" appears in the upper line of the display during talking.
4. To request the cellular system not to use the enhanced voice privacy service, select "Standard" with  or , and press .

Notes: 1. This feature must be activated before the call is initiated.

2. Even if the standard mode is selected, the cellular system may direct the phone to use the Enhanced Voice Privacy Mode.

Security Features

Call Restriction (F61)

This feature permits you to impose various kinds of restrictions on outgoing calls. Emergency numbers can be placed even when this feature is on.

To Set Call Restriction Mode

1. Press **F** **6** **MNO** **1**.

2. Enter the four-digit security code and press **F**.

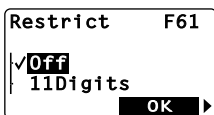

3. You can select the mode by **▲** or **▼**.

4. Press **F** to set.

The available Restriction modes are as follows:

- **11 Digits Mode**

Only phone numbers of 11 digits or less are accepted. Operator assisted dialing is prohibited.

- **7 Digits Mode**

Only phone numbers of 7 digits or less are accepted. Operator assisted dialing is prohibited.

- **Operator Mode**

Operator assisted dialing (0 Origination Call) is prohibited.

- **Rcl 01-09 Mode**

Only outgoing calls to the numbers stored in the phonebook address range 01 – 09 can be made. If there is a need to expand this range of addresses please ask your dealer.

- **Off Mode**

No restriction.

To Change Emergency Numbers (F62)

You can program your own emergency numbers. Up to 3 numbers of maximum 32 digits can be stored.

Memory Location	Preset Emergency Number
# 1	911
# 2	*911
# 3	Blank

1. Press **F** **6** **MNO** **2** **ABC**.

2. Enter the four-digit security code and press **F**.

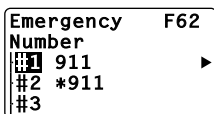

3. Press **▲** or **▼** to select the emergency number memory location (1, 2 or 3) that you want to change or program, and press **F**.

4. Enter the new emergency number, and press **F**.

Note: The emergency number in memory location 1 will be dialed when the **One-Touch Emergency Call** feature is used.

To Turn On/Off One-Touch Emergency Call Feature (F63)

1. Press **F▶** **6**_{MNO} **3**_{DEF}.
2. Enter the four-digit security code and press **F▶**.

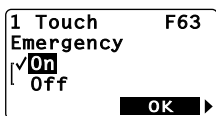

3. You can turn this feature on/off by **▲** or **▼**.
4. Press **F▶** to set.

To Change the Security Code (F64)

1. Press **F▶** **6**_{MNO} **4**_{GHI}.
2. Enter the four-digit security code and press **F▶**.

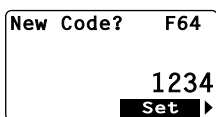

3. The current security code is displayed.
4. Enter a new four-digit security code and press **F▶**.

Call Timer Reset (F65-1)

This feature resets all the following four Call Timers; Last Call Timer, Outgoing Call Timer, All Calls Timer and Web Total Timer.

1. Press **F▶** **6**_{MNO} **5**_{JKL}.
2. Enter the four-digit security code and press **F▶**.



3. Press **1**.
4. Press **F▶** to reset the call timers.

Phonebook All Clear (F65-2)

This feature clears all the phonebook locations (01 to 99) and the voice mail dialing memory **V+⟨**.

1. Press **F▶** **6**_{MNO} **5**_{JKL}.
2. Enter the four-digit security code and press **F▶**.



3. Press **2**_{ABC}.
4. Press **F▶** to clear the memory.

Call History All Clear (F65-3)

This feature clears the call history for outgoing and incoming calls including Caller ID.

1. Press **F▶** **6**MNO **5**JKL.
2. Enter the four-digit security code and press **F▶**.
3. Press **3**DEF.
4. Press **F▶** to clear the history.



Text Message & Voice Mail All Clear (F65-4)

This feature clears all Text Messages and the Voice Mail Notification.

1. Press **F▶** **6**MNO **5**JKL.
2. Enter the four-digit security code and press **F▶**.
3. Press **4**GHI.
4. Press **F▶** to clear the message.



Function Reset (F65-5)

This feature resets the User-Programmable functions.

1. Press **F▶** **6**MNO **5**JKL.
2. Enter the four-digit security code and press **F▶**.
3. Press **5**JKL.
4. Press **F▶** to reset.



Note: See **Function Reset Status** on page 90.

Data Communications







Data/Fax Mode (F71)

Your CDM-9100 will work as a wireless modem, if connected to a PC laptop or a computer with the optional data cable (DIC-9100). When operating in Digital mode, the phone can be used for Async Data or Fax at the speed of up to 14.4kbps. Your CDM-9100 also supports QNC (Quick Network Connection) for faster internet access. The data/fax features are available while the  indicator is on.

To Receive Data/Fax Call

1. Press   .



2. Scroll the menu, and press  to select one of the modes described below.
3. During data/fax calls, you can use only  key.
4. To exit from the data/fax mode, press   , and scroll to "Off", then press .

Data: Data mode until the power is turned off.

Fax: Fax mode until the power is turned off.

Data Once: Data mode for one call only.

Fax Once: Fax mode for one call only.

- Notes:**
1. "Data Once" or "Fax Once" mode will be automatically reset to "Off" mode after receiving data/fax once, or in 10 minutes.
 2. You cannot receive voice calls in data/fax modes.
 - 3 For additional details on connecting your phone to your PC, please refer to instructions in the DIC-9100 Data Cable Kit.
 4. To place data/fax call or access internet through a PC, it is not necessary to set the phone in data/fax mode.

Vibrator

Vibrating Alert (F8)

When this feature is activated, the phone vibrates to alert you of the following items while in standby mode. The audible alerts below will be muted.

- Incoming call received, even in **Silent** mode.
- New Text Message received, even in **Alert Off** mode.
- New Voice Mail Notification received, even in **Alert Off** mode.
- Caller ID Alert, if activated.
- Service Mode Alert, if activated.
- Clock Alarm Alert, if activated.
- Countdown Timer Alert, if activated.

To Activate Vibrating Alert

Press **F**, **8 TUV**, scroll to "On" and press **F**. The  indicator will be displayed.



To Deactivate Vibrating Alert

Press **F**, **8 TUV**, scroll to "Off" and press **F**. The  indicator will go out.

Shortcut: Press and hold ***↑** to activate or deactivate it.

Note: Be sure to turn the Vibrating Alert feature off when you use the phone in the hands-free car kit accessory.

Other Functions

Quick Dialing (F01)

When this feature is on, the primary number in your phonebook address 02 to 09 can be dialed with just a single press of the key.

1. Press **F** **0** **1**.
2. Scroll to "On" or "Off" and press **F**.



Automatic Answering (F02)

With this feature on, incoming calls will be automatically answered after a preset duration of ringer tones. This feature may be convenient when your telephone is installed in the hands-free car kit.

1. Press **F** **0** **2**.
2. Scroll to "On" and press **F**.
3. Enter duration (5 to 30) in seconds.
4. Press **F** to set.



Note: This feature will not function if the phone is in "Phone Lock", or "Keypad Lock" mode.

Redial Soft Key (F04)

This feature turns the "Redial" and "Refer" soft keys on or off.

1. Press **F** **0** **4**.
2. Scroll to "On" or "Off".
3. Press **F** to set.

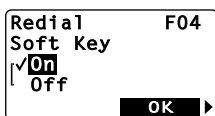

Function Reset Status

By **Function Reset (F65-5)** on page 86, your CDM-9100 will be reset as in the chart below.

Function Menu

Functions		Reset Status
Automatic Phone Lock (F13)		Off
Backlight Control (Standby) (F22-1)	Portable Use	10 seconds
	With Car Kit	Always On
Backlight Control (In-Use) (F22-2)		Normal
Auto Hyphenation (F23)		On
Language Selection (F24)		English
Contrast Control (F25)		Standard
Earpiece Volume Control		Level 3 (Max = 5)
Ringer Volume Control (F31)		Level 3 (Max = 5)
Ringer Type Selection (F32)		Ringer #1
Key Tone Volume Control (F33)		Level 3 (Max = 5)
Sending DTMF (F34)		On
Key Tone Length (F35-1)		Normal
Single Alert Beep Tone (F35-2)		Off
Caller ID Alert (F35-3)		On
Service Mode Alert (F35-4)		Off
Voice Privacy Alert (F35-5)		Off
One Minute Beep Tone (F35-6)		Off
Low Battery Alarm (F35-7)		On
Clock Indicator (F42)		On
Clock Adjustment (F43)		Auto
Clock Alarm (F44)		Off
Countdown Timer (F45)		0 minute
System Mode Selection (F51)		Automatic
NAM Selection (F52)		NAM #1
Automatic NAM (F54-2)		Off
Automatic Retry (F54-3)		Off
Voice Privacy Service (F54-4)		Standard
Call Restriction (F61)		Off
One-Touch Emergency Call (F63)		On
Data/Fax Mode (F71)		Off
Vibrating Alert (F8)		Off
Quick Dialing (F01)		On
Automatic Answering (F02)		Off
*Calls-in-Absence Indicator (F03)		Off
Redial Soft Key (F04)		On

* Affects hands-free operation only.

Refer to Hands-Free Car Kit (HF-9100) manual.

Function Reset Status (continued)

Messaging Feature Settings

Functions	Reset Status
Default Call Back Number	Own phone number
Default Delivery Ack	Enhanced Ack
New Message Alert	Alert On
Voice Mail Alert	Alert On
Entry Mode	T9 Mode
Save Sent Message	Auto Save
SMS Lines	4 Lines
SMS Memory Management	Auto Delete

See page 61 – 62.

Web Browser Settings

Functions	Reset Status
Web Lock	Off
Web Backlight	30 seconds
Web Idle Timer	30 seconds
Connect Prompt	On

See page 65 – 66.

FACEPLATE OPTIONS

Your CDM-9100 phone's faceplate is available in various color options. Always use and store your phone with the faceplate attached.

To Replace Faceplates

1. Turn the phone off and remove the battery pack. Disconnect the phone from the AC Adapter or any other device.
2. Unscrew a screw with a size S Phillips-head screwdriver. The screw stays on the phone.
3. Put a coin in a slot at top of the phone and twist it.
4. Pull the top of the faceplate forward to open it.
5. Hold the phone leaning on your hand. Place the bottom of the faceplate against the bottom of the phone so that the inner tabs fit the slots. Close the faceplate and snap it shut. Make sure that all seven hooks are closed and all keys operate smoothly.
6. Tighten the screw.

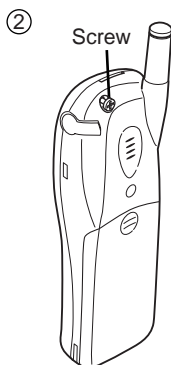

Note: Prevent any dust or small things going into the phone.

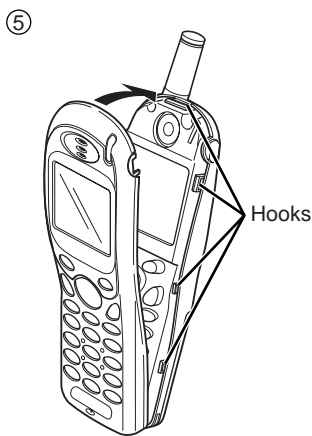
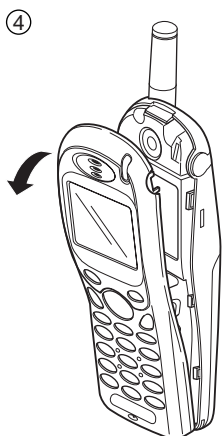

Memo



The U.S. Food and Drug Administration's Center for Devices and Radiological Health Consumer Update on Mobile Phones

FDA has been receiving inquiries about the safety of mobile phones, including cellular phones and PCS phones. The following summarizes what is known—and what remains unknown—about whether these products can pose a hazard to health, and what can be done to minimize any potential risk. This information may be used to respond to questions.

Why the concern?

Mobile phones emit low levels of radiofrequency energy (i.e., radiofrequency radiation) in the microwave range while being used. They also emit very low levels of radiofrequency energy (RF), considered non-significant, when in the stand-by mode. It is well known that high levels of RF can produce biological damage through heating effects (this is how your microwave oven is able to cook food). However, it is not known whether, to what extent, or through what mechanism, lower levels of RF might cause adverse health effects as well. Although some research has been done to address these questions, no clear picture of the biological effects of this type of radiation has emerged to date. Thus, the available science does not allow us to conclude that mobile phones are absolutely safe, or that they are unsafe. However, the available scientific evidence does not demonstrate any adverse health effects associated with the use of mobile phones.

What kinds of phones are in question?

Questions have been raised about hand-held mobile phones, the kind that have a built-in antenna that is positioned close to the user's head during normal telephone conversation. These types of mobile phones are of concern because of the short distance between the phone's antenna—the primary source of the RF—and the person's head. The exposure to RF from mobile phones in which the antenna is located at greater distances from the user (on the outside of a car, for example) is drastically lower than that from hand-held phones, because a person's RF exposure decreases rapidly with distance from the source. The safety of so-called "cordless phones," which have a base unit connected to the telephone wiring in a house and which operate at far lower power levels and frequencies, has not been questioned.

How much evidence is there that hand-held mobile phones might be harmful?

Briefly, there is not enough evidence to know for sure, either way; however, research efforts are on-going. The existing scientific evidence is conflicting and many of the studies that have been done to date have suffered from flaws in their research methods. Animal experiments investigating the effects of RF exposures characteristic of mobile phones have yielded conflicting results. A few animal studies, however, have suggested that low levels of RF could accelerate the development of cancer in laboratory animals. In one study, mice genetically altered to be predisposed to developing one type of cancer developed more than twice as many such cancers when they were exposed to RF energy compared to controls. There is much uncertainty among scientists about whether results obtained from animal studies apply to the use of mobile phones. First, it is uncertain how to apply the results obtained in rats and mice to humans. Second, many of the studies that showed increased tumor development used animals that had already been treated with cancer-causing chemicals, and other studies exposed the animals to the RF virtually continuously—up to 22 hours per day.

For the past five years in the United States, the mobile phone industry has supported research into the safety of mobile phones. This research has resulted in two findings in particular that merit additional study:

1. In a hospital-based, case-control study, researchers looked for an association between mobile phone use and either glioma (a type of brain cancer) or acoustic neuroma (a benign tumor of the nerve sheath). No statistically significant association was found between mobile phone use and acoustic neuroma. There was also no association between mobile phone use and gliomas when all types of types of gliomas were considered together. It should be noted that the average length of mobile phone exposure in this study was less than three years.

When 20 types of glioma were considered separately, however, an association was found between mobile phone use and one rare type of glioma, neuroepitheliomatous tumors. It is possible with multiple comparisons of the same sample that this association occurred by chance. Moreover, the risk did not increase with how often the mobile phone was used, or the length of the calls. In fact, the risk actually decreased with cumulative hours of mobile phone use. Most cancer causing agents increase risk with increased exposure. An ongoing study of brain cancers by the National Cancer Institute is expected to bear on the accuracy and repeatability of these results.¹

2. Researchers conducted a large battery of laboratory tests to assess the effects of exposure to mobile phone RF on genetic material. These included tests for several kinds of abnormalities, including mutations, chromosomal aberrations, DNA strand breaks, and structural changes in the genetic material of blood cells called lymphocytes. None of the tests showed any effect of the RF except for the micronucleus assay, which detects structural effects on the genetic material. The cells in this assay showed changes after exposure to simulated cell phone radiation, but only after 24 hours of exposure. It is possible that exposing the test cells to radiation for this long resulted in heating. Since this assay is known to be sensitive to heating, heat alone could have caused the abnormalities to occur. The data already in the literature on the response of the micronucleus assay to RF are conflicting. Thus, follow-up research is necessary.²

FDA is currently working with government, industry, and academic groups to ensure the proper follow-up to these industry-funded research findings. Collaboration with the Cellular Telecommunications & Internet Association (CTIA) in particular is expected to lead to FDA providing research recommendations and scientific oversight of new CTIA-funded research based on such recommendations.

Two other studies of interest have been reported recently in the literature:

1. Two groups of 18 people were exposed to simulated mobile phone signals under laboratory conditions while they performed cognitive function tests. There were no changes in the subjects' ability to recall words, numbers, or pictures, or in their spatial memory, but they were able to make choices more quickly in one visual test when they were exposed to simulated mobile phone signals. This was the only change noted among more than 20 variables compared.³

¹ Muscat et al. Epidemiological Study of Cellular Telephone Use and Malignant Brain Tumors. In: State of the Science Symposium; 1999 June 20; Long Beach, California.

² Tice et al. Tests of mobile phone signals for activity in genotoxicity and other laboratory assays. In: Annual Meeting of the Environmental Mutagen Society; March 29, 1999, Washington, D.C.; and personal communication, unpublished results.

³ Preece, AW, Iwi, G, Davies-Smith, A, Wesnes, K, Butler, S, Lim, E, and Varey, A. Effect of a 915-MHz simulated mobile phone signal on cognitive function in man. *Int. J. Radiat. Biol.*, April 8, 1999.

2. In a study of 209 brain tumor cases and 425 matched controls, there was no increased risk of brain tumors associated with mobile phone use. When tumors did exist in certain locations, however, they were more likely to be on the side of the head where the mobile phone was used. Because this occurred in only a small number of cases, the increased likelihood was too small to be statistically significant.⁴

In summary, we do not have enough information at this point to assure the public that there are, or are not, any low incident health problems associated with use of mobile phones. FDA continues to work with all parties, including other federal agencies and industry, to assure that research is undertaken to provide the necessary answers to the outstanding questions about the safety of mobile phones.

What is known about cases of human cancer that have been reported in users of hand-held mobile phones?

Some people who have used mobile phones have been diagnosed with brain cancer. But it is important to understand that this type of cancer also occurs among people who have not used mobile phones. In fact, brain cancer occurs in the U.S. population at a rate of about 6 new cases per 100,000 people each year. At that rate, assuming 80 million users of mobile phones (a number increasing at a rate of about 1 million per month), about 4800 cases of brain cancer would be expected each year among those 80 million people, whether or not they used their phones. Thus it is not possible to tell whether any individual's cancer arose because of the phone, or whether it would have happened anyway. A key question is whether the risk of getting a particular form of cancer is greater among people who use mobile phones than among the rest of the population. One way to answer that question is to compare the usage of mobile phones among people with brain cancer with the use of mobile phones among appropriately matched people without brain cancer. This is called a case-control study. The current case-control study of brain cancers by the National Cancer Institute, as well as the follow-up research to be sponsored by industry, will begin to generate this type of information.

What is FDA's role concerning the safety of mobile phones?

Under the law, FDA does not review the safety of radiation-emitting consumer products such as mobile phones before marketing, as it does with new drugs or medical devices. However, the agency has authority to take action if mobile phones are shown to emit radiation at a level that is hazardous to the user. In such a case, FDA could require the manufacturers of mobile phones to notify users of the health hazard and to repair, replace or recall the phones so that the hazard no longer exists.

Although the existing scientific data do not justify FDA regulatory actions at this time, FDA has urged the mobile phone industry to take a number of steps to assure public safety. The agency has recommended that the industry:

- support needed research into possible biological effects of RF of the type emitted by mobile phones;
- design mobile phones in a way that minimizes any RF exposure to the user that is not necessary for device function; and
- cooperate in providing mobile phone users with the best possible information on what is known about possible effects of mobile phone use on human health.

⁴ Hardell, L, Nasman, A, Pahlson, A, Hallquist, A and Mild, KH. Use of cellular telephones and the risk for brain tumors: a case-control study. *Int. J. Oncol.*, 15: 113-116, 1999.

At the same time, FDA belongs to an interagency working group of the federal agencies that have responsibility for different aspects of mobile phone safety to ensure a coordinated effort at the federal level. These agencies are:

- National Institute for Occupational Safety and Health
- Environmental Protection Agency
- Federal Communications Commission
- Occupational Health and Safety Administration
- National Telecommunications and Information Administration

The National Institutes of Health also participates in this group.

In the absence of conclusive information about any possible risk, what can concerned individuals do?

If there is a risk from these products—and at this point we do not know that there is—it is probably very small. But if people are concerned about avoiding even potential risks, there are simple steps they can take to do so. For example, time is a key factor in how much exposure a person receives. Those persons who spend long periods of time on their hand-held mobile phones could consider holding lengthy conversations on conventional phones and reserving the hand-held models for shorter conversations or for situations when other types of phones are not available.

People who must conduct extended conversations in their cars every day could switch to a type of mobile phone that places more distance between their bodies and the source of the RF, since the exposure level drops off dramatically with distance. For example, they could switch to:

- a mobile phone in which the antenna is located outside the vehicle,
- a hand-held phone with a built-in antenna connected to a different antenna mounted on the outside of the car or built into a separate package, or
- a headset with a remote antenna to a mobile phone carried at the waist.

Again, the scientific data do not demonstrate that mobile phones are harmful. But if people are concerned about the radiofrequency energy from these products, taking the simple precautions outlined above can reduce any possible risk.

Where can I find additional information?

For additional information, see the following websites:

Federal Communications Commission (FCC) RF Safety Program (select “Information on Human Exposure to RF Fields from Cellular and PCS Radio Transmitters”): <http://www.fcc.gov/oet/rfsafety>

World Health Organization (WHO) International Commission on Non-Ionizing Radiation Protection (select Qs & As): <http://www.who.int/emf>

United Kingdom, National Radiological Protection Board: <http://www.nrpb.org.uk>

Cellular Telecommunications & Internet Association (CTIA): <http://www.wow-com.com>

U.S. Food and Drug Administration (FDA) Center for Devices and Radiological Health: <http://www.fda.gov/cdrh/consumer/>

OPERATING PROCEDURES

Never violate any of the following Rules and Regulations of the FCC when using your Cellular Phone. Such violations are punishable by fine, imprisonment or both.

- Never use obscene, indecent, or profane language.
- Never use your Cellular Phone to send false distress calls.
- Never wiretap or otherwise intercept a phone call, unless you have first obtained the consent of the parties participating in the call.
- Never make any anonymous calls to annoy, harass, or molest other people.
- Never charge another account without authorization, to avoid payment for service.
- Never willfully or maliciously interfere with any other radio communications.
- Never refuse to yield the line when informed that it is needed for an Emergency Call. Also, never take over a line by stating falsely that it is needed for an emergency.

Emergency Calls

- Never rely solely upon your wireless phone for essential communications (e.g. medical emergencies), if it can be avoided, since a wireless phone requires a complex combination of radio signals, relay stations and landline networks for its operation. Consequently, emergency calls may not always be possible under all conditions on all wireless phone systems.
- Your wireless phone, however, may sometimes be the only available means of communication at the scene of an accident. When making an emergency call, always give the recipient all necessary information as accurately as possible. Never terminate an emergency call until you have received clearance to do so.

INDEX

- A**
Alpha Mode 32
Any Key Answering 27
Automatic Answering 89
- B**
Backlight Control
In-Use 72
Standby 71
Battery
Alarm 76
Attach/Detach 19
Recharge 20
- C**
Call
Place 25
Receive 27
Terminate 25
Call History 52
All Clear 86
Call Restriction 84
Calls-in-Absence Indicator ... 28
Call Timers 76
Reset 85
Call Waiting 29
Caller ID 28
Alert 75
Clock Alarm 30, 78
Clock Indicator 30, 77
Contrast 72
Countdown Timer 30, 79
- D**
Data/Fax 87
Distinctive Ringing 28
DTMF 74
- E**
E-mail 39, 45, 57, 64
Emergency Call 26
One-Touch 27, 85
Emergency Number
Change 84
Enhanced Roaming 80
- F**
Force Analog Call 81
Function Menu
Access 67
Tree 68
Function Reset 86
- H**
Hyphenation
Auto 36, 72
Manual 36
- K**
Keypad Lock 69
- L**
Language 30, 72
Link Dialing 50
- M**
Mute 29
- N**
NAM
Automatic 82
Selection 81
Name Display 82
- O**
Own Telephone
Number 71
- P**
Phone Lock 70
Automatic 70
Unlock 70
Phonebook
All Clear 85
Phonebook Edit
Change Priority 48
Erase 48
Modify 46
Move 47
Phonebook Entry
Automatic Storing 35
Dual Numbers 37
Name 38
Number 35
Overwrite 41
Ringer Type 40
Phonebook Recall
Address Mode 43
Key Word Search Mode ... 44
Sort Scroll Mode 43
Prepending Dialing 45
PRL 73, 80
- Q**
Quick Dialing 26, 89
- R**
Recall Menu 42
Retry 82
Ringer Type 74
Ringtone 28
- S**
Scratch Pad 29, 54
Secret Memory 49
Security Code 69, 85
Short Message Service ... 55
SID 73, 80
Speakerphone 29
Speed Dialing 26
System Mode Selection ... 80
- T**
Talk Timer 29
Text Messages 55
Alert 61
All Clear 86
Receive 56
Send 57
Touch Tone™
from Display 31
from Memory 31
- U**
Unlock Code 69, 70
- V**
Vibrating Alert 30, 88
Voice Mail
Alert 62
All Clear 86
Dialing (Vv/vj) 60
Notification 59
Voice Privacy 83
Alert 75
Volume
Earpiece 28
Key Tone 74
Ringer 73
- W**
Web Browsing 63

The CDM-9100 is using one or more of the following US patents licensed by QUALCOMM Incorporated:

4,901,307	5,544,196
5,490,165	5,267,262
5,056,109	5,568,483
5,504,773	5,337,338
5,101,501	5,600,754
5,506,865	5,414,796
5,109,390	5,657,420
5,511,073	5,416,797
5,228,054	5,659,569
5,535,239	5,710,784
5,267,261	5,778,338

T9® Text Input is covered by U.S. Pat. 5,818,437, U.S. Pat. 5,953,541, U.S. Pat. 6,011,554 and other patents pending.

12 MONTH LIMITED WARRANTY

AUDIOVOX COMMUNICATIONS CORP. (the Company), warrants to the original retail purchaser of this Audiovox Handheld Portable Cellular Telephone, that should this product or any part thereof (except the items listed below), under normal use and conditions, be proven defective in material or workmanship within the first twelve (12) month period from the date of purchase, such defect(s) will be repaired or replaced (with new or rebuilt parts) at the Company's option, without charge for parts or labor directly related to the defect(s).

The keypad and display are similarly warranted for ninety (90) days from date of purchase.

The accessories consisting of the rechargeable battery pack and desktop charger are similarly warranted for twelve (12) months from original purchase.

This Warranty does not apply to:

- (a) Any damage that has resulted from the connection to, or use of, any accessories not expressly approved by Audiovox;
- (b) Battery Packs, fuses, or any costs incurred for testing or checking;
- (c) Theft, battery leakage or use of an improper electrical source;
- (d) Any product or component that has been subjected to serial number defacement, misuse, physical abuse, unauthorized alteration or repair, improper installation, mishandling, neglect or improper storage;
- (e) Any damage that has resulted from exposure to excessive temperature or humidity, exposure to excessive moisture or dampness, or exposure to extreme environmental or weather conditions; or,
- (f) Any accidental damage, whether caused by impact with another object, fire, flood or other event.

This Warranty is not assignable or transferable.

To obtain repairs or replacement within the terms of this Warranty, the product should be delivered with proof of warranty coverage, specification of defect(s), transportation prepaid, to the Company at the address shown below. For TRAVELERS WARRANTY SERVICE.

Call toll free to (800) 229-1235 (in N.Y. State, (631) 233-3410) for reference to an Authorized Warranty Station in your area.

THE EXTENT OF THE COMPANY'S LIABILITY UNDER THIS WARRANTY IS LIMITED TO THE REPAIR OR REPLACEMENT PROVIDED ABOVE AND, IN NO EVENT, SHALL THE COMPANY'S LIABILITY EXCEED THE PURCHASE PRICE PAID BY PURCHASER FOR THE PRODUCT.

The Company disclaims liability for geographic coverage, inadequate signal to antenna, communications range or operation of the Cellular System as a whole.

ANY IMPLIED WARRANTIES, INCLUDING ANY IMPLIED WARRANTY OF MERCHANTABILITY SHALL BE LIMITED TO THE DURATION OF THIS WRITTEN WARRANTY. ANY ACTION FOR BREACH OF ANY WARRANTY HEREUNDER INCLUDING ANY IMPLIED WARRANTY OF MERCHANTABILITY MUST BE BROUGHT WITHIN A PERIOD OF 24 MONTHS FROM DATE OF ORIGINAL PURCHASE. IN NO CASE SHALL THE COMPANY BE LIABLE FOR ANY CONSEQUENTIAL OR INCIDENTAL DAMAGES FOR BREACH OF THIS OR ANY OTHER WARRANTY, EXPRESS OR IMPLIED, WHATSOEVER.

No person or representative is authorized to assume for the Company any liability other than expressed herein in connection with the sale of this product.











Some states do not allow limitations on how long an implied warranty lasts or the exclusion or limitation of incidental or consequential damage so the above limitation or exclusions may not apply to you. This Warranty gives you specific legal rights, and you may also have other rights which vary from state to state.

IN U.S.A.: AUDIOVOX COMMUNICATIONS
CORP.
555 Wireless Blvd., Hauppauge,
New York 11788
(800) 229-1235











IN CANADA: AUDIOVOX CANADA LTD.
5155 Spectrum Way, Unit #5
Mississauga, Ontario L4W 5A1
(905) 712-9299

Quick Reference

Basic Operation

Turn On/Off	Press and hold 
Place a Call	Phone Number, 
Terminate a Call	
Receive a Call	Any Key (except  and )
Clear Last Digit	
Clear All Digits	Press and hold 
Ear/SPK Volume	 or  during a call
Speakerphone (One-Way)	 during a call

Convenience Features











Phonebook Dialing	 , Phonebook Address, 
Speed Dialing	Phonebook Address, 
Last Number Redial	  
Dial last Number Received	  
Vibrating Alert	Press and hold 

Messaging Features



Received Text Messages	Press and hold 
Number of Voice Mail	 , "Voice mail", 
Voice Mail Dialing	

Quick Reference





Basic Operation

Turn On/Off	Press and hold 
Place a Call	Phone Number, 
Terminate a Call	
Receive a Call	Any Key (except  and )
Clear Last Digit	
Clear All Digits	Press and hold 
Ear/SPK Volume	 or  during a call
Speakerphone (One-Way)	 during a call

Convenience Features

Phonebook Dialing	 , Phonebook Address, 
Speed Dialing	Phonebook Address, 
Last Number Redial	  
Dial last Number Received	  
Vibrating Alert	Press and hold 

Messaging Features

Received Text Messages	Press and hold 
Number of Voice Mail	 , "Voice mail", 
Voice Mail Dialing	

Functions

Mute/Unmute	F▶ F▶
Keypad Lock	F▶ 1 1
Lock the Phone	F▶ 1 2 ABC
Automatic Lock	F▶ 1 3 DEF
Display Own Phone Number & SID	F▶ 2 ABC 1
Backlight Control	F▶ 2 ABC 2 ABC
Language Selection	F▶ 2 ABC 4 GHI
Last Call Time Display	F▶ 4 GHI 1
Outgoing Call Time Display	F▶ 4 GHI 1 2 ABC
All Calls Time Display	F▶ 4 GHI 1 3 DEF
System Mode Selection	F▶ 5 JKL 1
Force Analog Call	F▶ 5 JKL 3 DEF
Data/Fax Mode	F▶ 7 PQRS 1
Vibrating Alert	F▶ 8 TUV
Automatic Answering	F▶ 0 ↻ 2 ABC

Functions

Mute/Unmute	F▶ F▶
Keypad Lock	F▶ 1 1
Lock the Phone	F▶ 1 2 ABC
Automatic Lock	F▶ 1 3 DEF
Display Own Phone Number & SID	F▶ 2 ABC 1
Backlight Control	F▶ 2 ABC 2 ABC
Language Selection	F▶ 2 ABC 4 GHI
Last Call Time Display	F▶ 4 GHI 1
Outgoing Call Time Display	F▶ 4 GHI 1 2 ABC
All Calls Time Display	F▶ 4 GHI 1 3 DEF
System Mode Selection	F▶ 5 JKL 1
Force Analog Call	F▶ 5 JKL 3 DEF
Data/Fax Mode	F▶ 7 PQRS 1
Vibrating Alert	F▶ 8 TUV
Automatic Answering	F▶ 0 ↻ 2 ABC

CDM-9100

**TRI-MODE CDMA DIGITAL WIRELESS
HANDSET with WEB BROWSER**

ACCESSORIES



BC-9100
Belt Clip



BTR-9100
Lithium Ion Battery



CLC-9100
Cigarette Lighter
Charger



CNR-9100
AC Adapter Charger



DIC-9100
Data Interface Cable



DTC-9100
Desktop Charger



DTH-9100
Desktop Holder



EM-425
Earphone
Microphone



HF-9100
Hands-Free Car Kit



LB-9100
Leather
Carrying Case



**User Changeable
Color Faceplates**
(actual colors may vary)

Not Shown: TRC-9100 Travel Charger

PROTECT YOUR WARRANTY

Carefully read the Limited Warranty for your cellular phone, giving special consideration to paragraph seven.

“Warranty does not apply to... any damage that has resulted from the connection to, or use of, any accessories not expressly approved by Audiovox”.

Some companies are marketing look-alike accessories that are not compatible for use with your Audiovox product and may damage the unit or cause it to malfunction.

If service is required on your unit, and it is determined that a non-Audiovox accessory has created the problem, your Warranty will not apply.

In addition, if the unit has sustained irreversible damage by reason of a non-compatible accessory, the Warranty will also be voided.

To protect your Warranty, always use compatible accessories that are approved by Audiovox and that cannot damage or interfere with the proper functioning of your cellular phone.



AUDIOVOX COMMUNICATIONS CORP.

555 Wireless Blvd., Hauppauge, New York 11788, 800-229-1235
16808 Marquardt Avenue, Cerritos, California 90701, 562-802-5100

Audiovox Canada
5155 Spectrum Way, Unit #5, Mississauga, Ontario
Canada L4W 5A1, 905-712-9299

Audiovox Pacific Pty Ltd
110 Rocky Point Road, Kogarah, NSW 2217, Australia,
02-9587-0000

Audiovox New Zealand Pty Ltd
Unit B, 6 Henderson Place, Auckland, 6496345720

Audiovox Singapore Pte Ltd
268 Orchard Road, #07-07, Singapore, 238856, 65-733-5902

<http://www.audiovox.com>

Free Manuals Download Website

<http://myh66.com>

<http://usermanuals.us>

<http://www.somanuals.com>

<http://www.4manuals.cc>

<http://www.manual-lib.com>

<http://www.404manual.com>

<http://www.luxmanual.com>

<http://aubethermostatmanual.com>

Golf course search by state

<http://golfingnear.com>

Email search by domain

<http://emailbydomain.com>

Auto manuals search

<http://auto.somanuals.com>

TV manuals search

<http://tv.somanuals.com>