



Division of Audiovox Corporation
185 Oser Ave., Hauppauge, NY 11788

PRINTED IN TAIWAN 5-95

TABLE OF CONTENTS

SYSTEM CONFIGURATION	5	Anti-fraud Security Feature	
WRIST STRAP ATTACHMENT	6	To Place a Call with a Number in the Memory	
BATTERY INSTALLATION AND		Speed Dialing	
RECHARGING	7	Last Three Number Redial	
To Attach the Battery Pack		Programmable Emergency Call (NAM Option)	
To Detach the Battery Pack		One Touch Emergency Call	
To Recharge Battery		To Mute a Phone Conversation	
PRECAUTIONS	9	VOICE MAIL DIALING	28
GENERAL SPECIFICATIONS	10	To Store Numbers	
FEATURES AND OPTIONS	11	To Place a Call	
FUNCTIONS	12	CALL RESTRICTION (NAM OPTION)	29
BASIC OPERATION	14	To Set Call Restricted Mode	
Turning the Unit On/Off		END-TO-END SIGNALING	30
• Antenna Position		Touch Tone™ from Memory	
• Receiving Signal Strength Indicator		Link Dialing	
• Battery Level Indicator		• To Link Number/To Store Linked Numbers	
To Store a Number in Memory		in Memory	
To Recall a Number from Memory		• To Place Linked Numbers	
To Review the Prefix		SCRATCH-PAD DIALING	32
Display Own Telephone Number		SCRATCH-PAD DIALING	
Repertory Memory Scroll		WITHOUT KEYING TONES	33
Automatic Storing into a Vacant Memory		CALL TIME DISPLAY	33
Address		To Display the Talk Time of the Last Call	
Secret Memory		To Display the Outgoing Call Timer Only	
• To Store the Secret Number		To Display the Cumulative Talk Time	
• To Confirm the Secret Number		To Clear the Timer	
To Lock the Unit		One Minute Beep (NAM Option)	
Automatic Lock		SID MANAGEMENT (NAM OPTION)	34
To Unlock the Unit		A/B SYSTEM SELECTION	35
Keypad Lock		MULTIPLE CITY REGISTRATION	36
Backlighting On/Off Control		LAST RESCAN SID INDICATOR	36
Volume Control		RADIO FREQUENCY (RF)	
• Earpiece		CHANNEL INDICATOR	37
• Alert Tone		AUTOMATIC CALLS IN ABSENCE	
MEMORY NAME TAG	20	INDICATOR	37
To Enter Names using Alpha (Letters)		FUNCTION MENU	38
To Store Name with Phone Number		SERIAL DATA MODE	40
To Recall from Memory with Name		FUNCTION ALL RESET	40
ALPHA SEARCH	22	IMPORTANT SAFETY INFORMATION	41
PLACING TELEPHONE CALLS	23	WARNING	41
To Place a Call		ACCESSORY CATALOG	44
If the Call Fails to Go Through			
Automatic Redial (NAM Option)			
Terminating a Call			
To Receive Calls			
Any Digit Key Answering			
Alert Tone Selection			
Silent Alert			
Automatic Answering			

Touch Tone™ is a registered trade mark of AT & T.

SYSTEM CONFIGURATION

MVX-850 Personal Cellular Data Communicator

Audiovox introduces the "Minivox MVX-850" the most technologically advanced Handheld Portable Cellular Telephone in the world. This Personal Cellular Data Communicator is only 100cc's in total volume, making it the smallest handheld telephone in the world. Weighing in at a mere 5.4 oz., the MVX-850, is also one of the lightest cellular telephones available today!

Utilizing the latest in microelectronics and battery technology, the MVX-850 delivers 65 minutes of talk time and 11 hours of standby time. The MVX-850 provides the most advanced features in one very compact unit to meet all your personal and business requirements like one touch emergency dialing and constant battery life and signal strength indicators.

The MVX-850 features a new LED call indicator, a key pad lock, one touch emergency dialing, a one touch voice mail access key and a large, easy to read, 30 character liquid-crystal display. The MVX-850 will also allow you the capability to send data or a facsimile via an optional PCMCIA card modem.

Optional accessories include: a 100 minute talk time, extended life nickel metal hydride battery, a 200 minute high capacity nickel metal hydride battery, a rapid charger, a cigarette lighter charger, and a handsfree car kit with provisions for external antenna and power booster. A travel charger and battery eliminator are also available.

And of course, your new Minivox MVX-850 comes with something only an Audiovox phone can provide. The proven reliability that has made Audiovox one of the worlds leading suppliers of cellular communications equipment.

System configuration and the equipment list are as shown below.

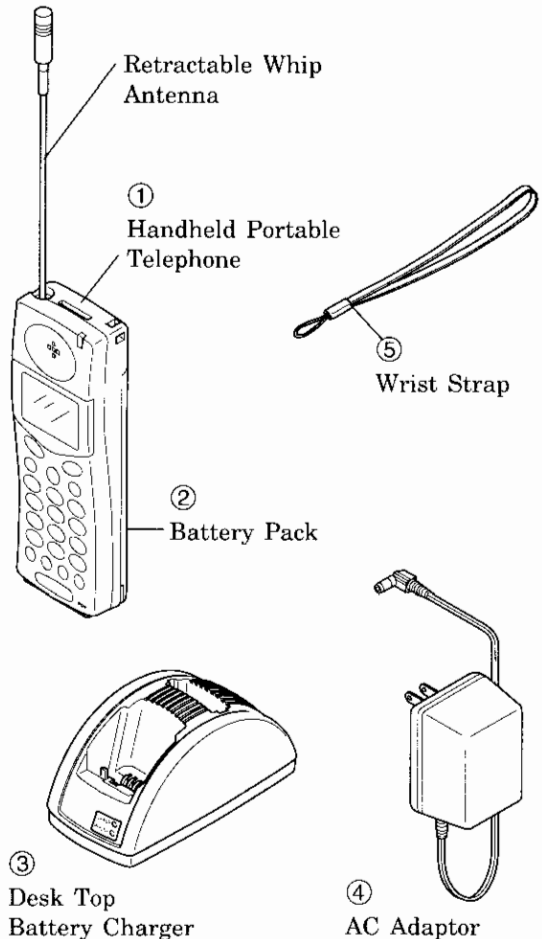

List of Equipment

No.	Name of the Equipment
①	Handheld Portable Telephone
②	Battery Pack
③	Desk Top Battery Charger (DTC-800)
④	AC Adaptor (CNR-800)
⑤	Wrist Strap (WS-700)

WRIST STRAP ATTACHMENT

Attach the wrist strap to the unit through the strap hole as shown below ①.

Then put the long loop through the smaller loop as shown below ②.

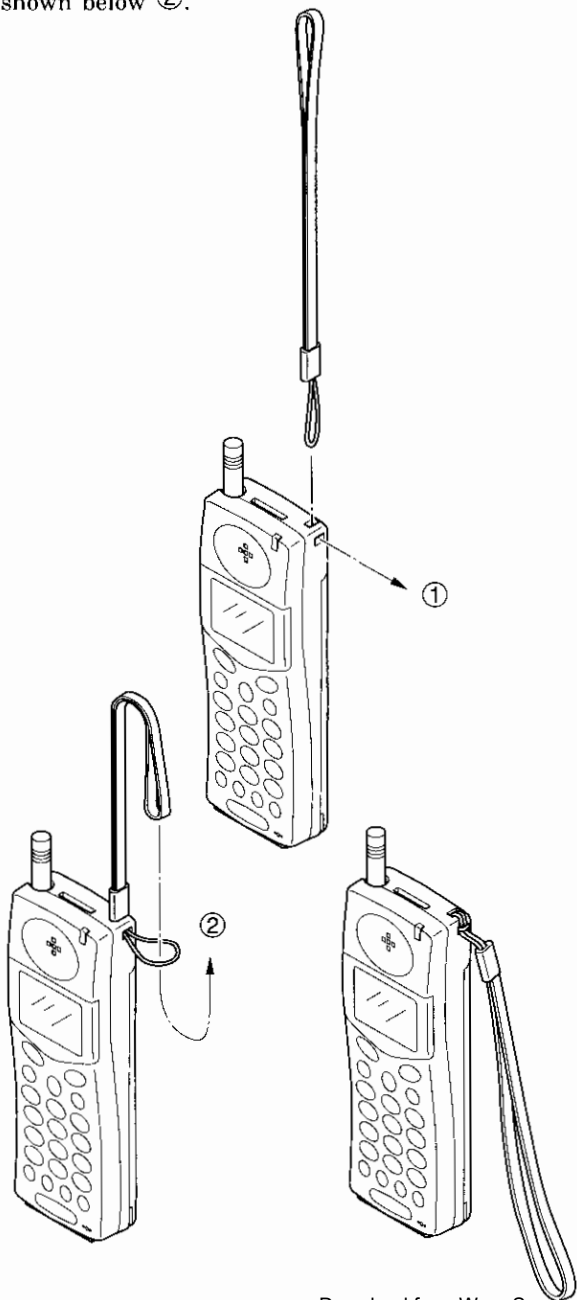

BATTERY INSTALLATION AND RECHARGING

The Portable Telephone contains a detachable Battery Pack (BTR-800). A fully charged Battery Pack offers 65 minutes Talk Time or 11 hours standby.

It is recommended to carry one fully charged spare Battery Pack for longer operation.

(Additional Battery Packs may be purchased at your Cellular Telephone Dealer.)

To Attach the Battery Pack

- ① Insert the hook at the end of the Battery Pack into the slot at the end of the unit.
- ② Press the Battery Pack down to lock the Battery Pack onto the unit.

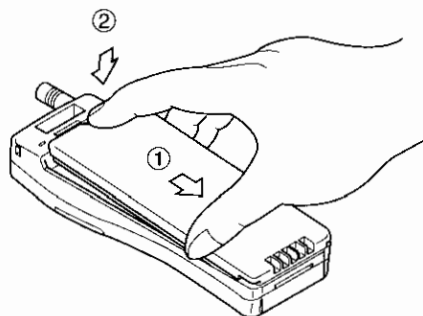

To Detach the Battery Pack

- ① Press the Release Latch as shown below.
- ② Lift up to remove the Battery Pack from the unit gently.

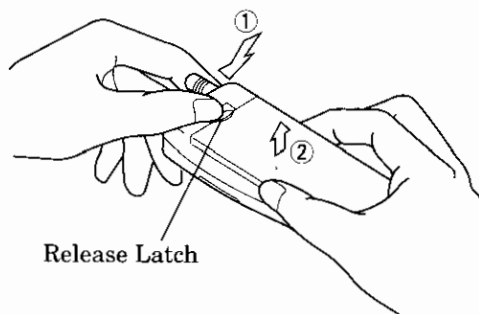

To Recharge Battery

The Desk Top Battery Charger (DTC-800) can recharge spare Battery and the Battery connected to the Portable Telephone at the same time. Moreover, the Battery Charger can recharge an optional Extended Life Battery (BTE-800) and a High Capacity Battery (BTX-800). DC voltage is supplied by the separate AC Adaptor. It takes approximately eight hours for full charge.

1. Two LEDs (Light Emitting Diode) on the Desk Top Battery Charger light green when DC voltage is supplied from the AC Adaptor.
2. The Battery charging starts when the Portable Phone and/or a spare Battery are/is placed into the Battery Charger, the LED(s) light(s) red.
3. When the charging is finished, the LED(s) return(s) a flash green.

Note: (1) Environmental temperature for full battery recharging with 8 hours: 0 ~ +35°C.

(2) We recommend you to turn off the power of the telephone to secure complete recharging of the battery.

(3) The Battery Charger and the Battery Pack will get warm during the charging cycle. This is normal.

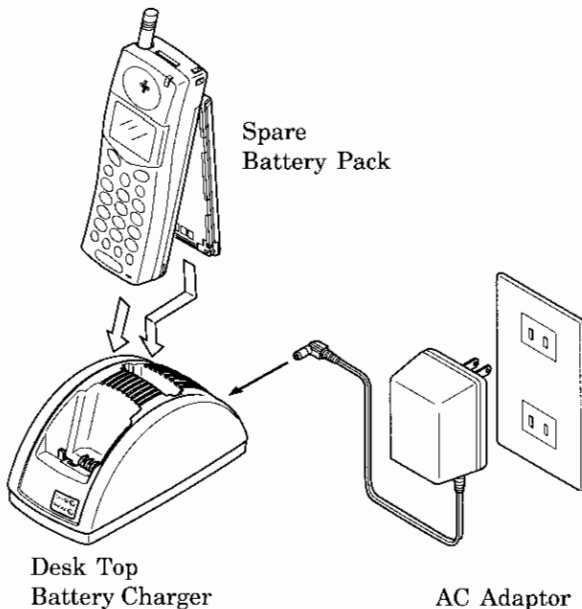

PRECAUTIONS

Your Handheld Portable Telephone is a high quality piece of equipment. Before operating the equipment, please take the following precautions.

1. Don't use this equipment in an extreme environment where high temperature or high humidity exists.
2. Don't abuse the equipment. Avoid striking, shaking or shocking. When not using the unit, lay down the unit to avoid possible damage due to instability.
3. Don't expose this equipment to rain or spilled beverages.
4. Recharge the battery fully before your first use of the unit.
5. When the battery becomes discharged, two beep tones will be heard every 10 seconds, and the display will show **Battery Discharged**. In such a case, replace the battery with a fully charged one, and recharge the discharged battery.
6. To ensure long battery life, operate the unit until **Battery Discharged** is displayed, before recharging the battery. Remove Battery Pack from the unit when it is not expected to be used for a long period.
Recharging at least once every month is recommended when not being used.
7. Don't charge the Battery in a place exposed to direct sunlight.
8. The Battery charging and charging timer will become inactive in case of lower or higher environmental temperature. (However, the LED remains at red.)

When the temperature returns to normal, the charging will be automatically resumed. In this case, it will take longer than 8 hours for the LED(s) to flash green.



Ni-MH

The product that you have purchased contains a rechargeable Battery. The Battery is recyclable. At the end of its useful life, under various state and local laws, it may be illegal to dispose of this Battery into the municipal waste stream. Check with your local solid waste officials for details in your area for recycling options or proper disposal.

GENERAL SPECIFICATIONS

(Subject to change without notice)

Frequency Range : 824 to 849 MHz, Transmit
869 to 894 MHz, Receive

Number of RF Channels : 832, Full Duplex

Channel Spacing : 30 KHz

Duplex Spacing : 45 MHz

Frequency Stability : ± 2.5 PPM

RF Output Power : 0.6W ERP With Power
Control

Receiver Sensitivity : -116 dBm (12 dB SINAD)

Modulation/Demodulation : Voice PM (With Comander)
Data FM

Operating Temperature : -20°C to $+60^{\circ}\text{C}$

Supply Voltage : 4.8 V

(NiMH Battery 1.2 V x 4,
550 mAH)

Current Drain : In Use;

Approx. 470 mA

Standby;

Approx. 50 mA

Operating Time : Talk;

Approx. 65 min.

(at full power output)

Standby;

Approx. 11 hours

Size : Approx.

23 (H) x 44 (W) x 128 (D) mm

0.90 (H) x 1.7 (W) x 5.0 (D) inch

Weight : Approx. 153 gr (5.4 oz)

FEATURES AND OPTIONS

- Push Button Dialing
- Backlit Keypad and Display with On/Off Control
- Incoming Call Indicator
- Large Size Dot-matrix LCD Display
 - Status/Function Indicator
 - 20 Digits Dial Number
 - Receiving Signal Strength Indicator
- Battery Level Indicator
- (Electronic) Volume Control
- Pre-set Dialing up to 32 Digits
- Extended Readability (Prefix Review)
- Last Digit Clear
- Digit Display Clear
- Programmable Emergency Call in locked or restricted modes
- One Touch Emergency Call
- Repertory Dialing: 32/80-Digit 100 Memories
- Speed Dialing
- Repertory Memory Scroll
- Automatic Storing into a Vacant Memory Address
- Secret Memory
- Memory Name Tag
- Alpha Search
- Linked Preset Dialing from Memory
- Voice Mail Dialing
- Any Digit Key Answering
- Automatic Answering
- Last Three Number Redial
- Automatic Redial (NAM Option)
- Mute or Hold
- Scratch-pad Dialing (with/without Keying Tones)
- End-to-End Signaling
- Touch Tone™ from Memory
- Continuous DTMF from Keypad
- Call Restrictions (NAM Option)
- Alert Tone Selection
- Silent Alert with Alert Beep Tone
- Call Time Display (Four Functions)
- Automatic Calls in Absence Indicator
- One Minute Beep (NAM Option)
- Display Own Telephone Number
- Multiple A/B System Selection
- SID Management (NAM Option)
- Multiple City Registration
- Last Rescan SID Indicator
- RF Channel Indicator
- Anti-fraud Security Feature
- Electronic Lock
- Automatic Lock
- Keypad Lock
- Function Menu
- Function All Reset

FUNCTIONS

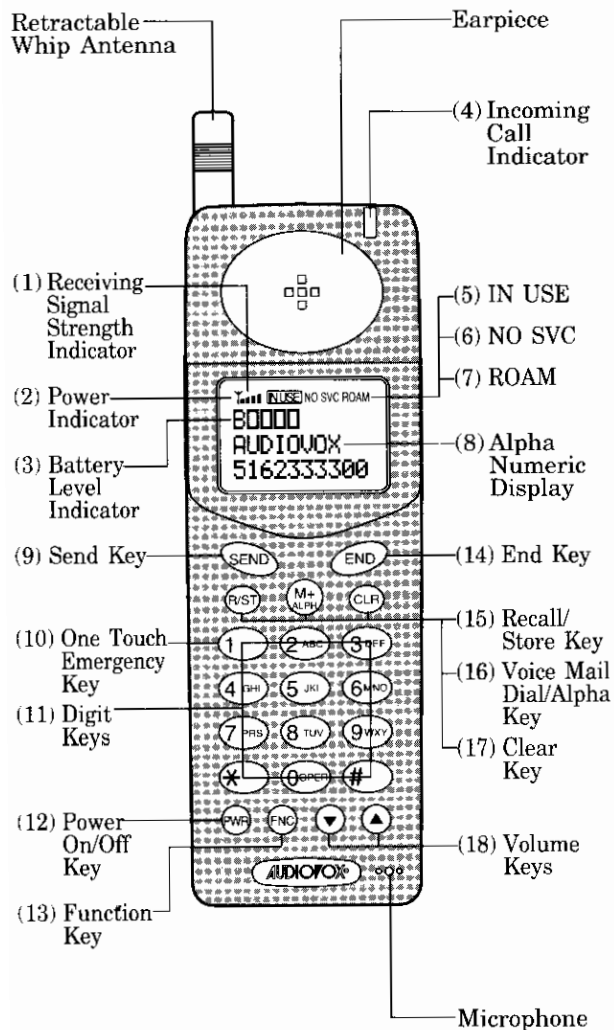

- (1) **RECEIVING SIGNAL STRENGTH INDICATOR:**
The number of shaded blocks indicates the Receiving Signal Strength.
- (2) **[Y]** is used as a POWER ON indicator which lights when the unit is turned on.
- (3) **B [] [] [] []** is used as a battery level indicator.
- (4) **INCOMING CALL INDICATOR:**
Flashing LED alerts you of an incoming call.
- (5) **[IN USE]** indicator lights when a call is in progress.
- (6) **[NO SVC]** (no service) indicator lights when the unit is in a non-coverage area.
- (7) **[ROAM]** indicator lights when the unit is out of the home area.
- (8) **30-CHARACTER FUNCTIONAL ALPHANUMERIC DISPLAY:**
First 10 characters indicate a battery level, current function and status conditions. The remaining 20 characters show the name and the last 10 digits of the dialed number.
- (9) **[SEND]** (send key) is used for placing or receiving a call.
- (10) **[1]** One Touch Emergency key.
- (11) **DIGIT KEYS** to enter a phone number.
- (12) **[PWR]** (power on/off key) is used to turn on/off the unit.
- (13) **[FNC]** (function key) shifts the digit keys to the functional keys.
- (14) **[END]** (end key) terminates a call.
- (15) **[RST]** (recall/store key)
 - To recall phone numbers from repertory memory, press **[RST]**.
 - To store phone numbers in repertory memory, press **[FNC] [RST]**.
- (16) **[M+]** (voice mail/alpha key)
 - To access the linked speed dialing capability, press **[M+]**.
 - To enter alphabetical characters, press **[FNC] [M+]**.
- (17) **[CLR]** (clear key) clears the digit(s) from the display.
- (18) **[VOLUME]** or **[VOLUME]** (volume key)
 - To control earpiece audio level, press **[VOLUME]** or **[VOLUME]**.
 - To control alert tone level, press **[FNC] [VOLUME]** or **[VOLUME]**.

BASIC OPERATION

Turning the Unit On/Off

Press **PWR** for about one second to turn on the unit. The indicator **Y** will light (all indicators will light momentarily: display will show the programmed name or your phone number, Incoming Call Indicator will light, and a tone will be heard). Press **PWR** again for about one second to turn off the unit.

• Antenna Position

Your portable cellular telephone has been equipped with a dual position antenna system.

This dual position antenna has been especially designed to allow your phone to receive calls while the antenna is down. However, for optimum performance and signal strength or while operating in poor signal areas, it is recommended that the antenna be fully extended.





Note: The antenna can be used in its fully extended or fully retracted position only.

• Receiving Signal Strength Indicator ■■■■

The number of shaded blocks indicates the Signal Strength in your area. Four blocks show the maximum level. The display will vary as you move with the unit. If the signal is not strong enough to place a call, the **NO SVC** indicator will appear on the readout.

• Battery Level Indicator

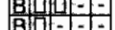
You can always monitor the current battery voltage level with the constant battery level indicator. The number of blocks indicates the battery conditions as follows:

	-	Full charge
	-	Normal phone call
	-	Short phone call
	-	Recharge battery

To Store a Number in Memory

1. Press **CLP**, then enter the phone number.
2. Press **FNC** **RST**, then enter the memory address (01 through 99).

Example: Press **FNC** **RST** **1** **5**, the displayed number will be stored into memory address 15.

To Recall a Number from Memory

Press **RST**, then enter the memory address (01 through 99).

Example: Press **RST** **1** **5**, the number stored in memory address 15 will be displayed on the readout.

To Review the Prefix

(Number longer than 10 digits)

After pressing **RST**, hold down the second digit of the memory address.

Display Own Telephone Number

You can see your system ID number and your own phone number on the readout. Press **RST** **#**.

Repertory Memory Scroll

This feature is useful in finding a certain phone number by scrolling the repertory memory from the designated memory address.

1. Press **RST**, then enter the memory address (01 through 99).

Note: Only memory address number is displayed, if no phone number is stored in memory address.

2. Press **▲** or **▼**.

▲ : Scroll upward (with roll back to 01)

▼ : Scroll downward (with roll up to 99)

Memory address and the last 10 digits of the stored number will be displayed on the readout as follows.

Example:

B	0	0	0	-	-	-	-	(3	1)
A	B	C	D	-	-	-	-	-	-	-	-
1	2	3	4	5	6	7	8	9	0		

Note: In this scroll feature, any vacant memory address(es) will be skipped.

To Lock the Unit

Press **FNG**, then key **1** (LOCK).

LOCK will appear on the readout. The unit will remain locked until unlocked, even if the power is turned off.

Automatic Lock

If you request the feature of Automatic Lock, so that your unit will automatically go into the locked condition when the power of the unit is turned "off". When **PWR** is turned "on", the unlock code is required to operate the unit.

1. Press **FNG** **7** **4**.

Auto Lock will appear on the readout.

The current mode will flash.

2. Press **1**, and Automatic Lock is activated.
3. Press **3**, and Automatic Lock is deactivated.

To Unlock the Unit

Enter the three-digit unlock code. The **LOCK** indicator will go out when the three-digit code is the same as the code registered in the NAM.

Keypad Lock

This feature makes the keypad temporarily inactive to prevent unintentional key operations while carrying the phone with the power on.

1. Press **FNG** **2**, and Keypad Lock mode is activated.
2. The **KeypadLock** will appear on the readout.
3. Press **FNG** **2**, and Keypad Lock mode is deactivated.

Note: The following functions are available when this feature is on.

- (1) To answer incoming call by **SEND** key.
- (2) Emergency Call (Except for OneTouch Emergency Call).
- (3) Silent Mode (Alert Tone Selection OFF Mode).

The following functions are not available when this feature is on.

- (1) Automatic Answering.
- (2) Any Key Answering.
- (3) OneTouch Emergency Call.
- (4) To turn off the unit by **PWR** key.

Backlighting On/Off Control

LCD display and the keypad are backlit automatically after the Power-On. If needed, backlighting can be turned off by pressing **FNG** **7** **3**.

Backlight will appear on the readout. The current mode will flash. Press **1**, and Backlight is activated.

Press **3**, and Backlight is deactivated.

Even if the unit is in the backlighting "Off" mode, the backlighting will be turned on again automatically for 10 seconds when any key operation is conducted or a call is received.

Volume Control

The audio level of the earpiece and the alert tone can be adjusted by the Volume Control Key.

▲ : To increase the sound level.

▼ : To decrease the sound level.

• Earpiece:

Keep pressing ▲ or ▼ until you get the desired sound level.

Sound level will be displayed on the readout digitally during the level adjustment and the sample tone will indicate the sound level when you are not engaged in a telephone conversation. The display format is as follows.

H.	S	Volume				-	Function	
		■	■	■	■	-	Current Volume	
				▲	or	▼	-	Key Operation

• Alert Tone:

Press **FNG**, ▲ or ▼.

Then adjust the alert tone level in the same manner as above. Your telephone will ring at the new level. In this case, the display format is as follows.

A	L	T	Volume				-	Function	
			■	■	■	■	-	Current Volume	
					▲	or	▼	-	Key Operation

MEMORY NAME TAG

This feature permits you to tag an identifying name (in up to 10 characters) to each phone number in the memory address. The name will be displayed each time you recall a number from memory address.

To Enter Names using Alpha (Letters)

1. Press **FNC** **M+M**. **Alpha** will appear on the readout to indicate the Alpha Mode is active.
2. Press digit keys repeatedly until the character you need appears. The following table shows which character is assigned with each digit key.

Key	ASSIGNED ALPHA CHARACTERS				
1	(Blank)	.	-	1	
2 (ABC)	A	B	C	2	
3 (DEF)	D	E	F	3	
4 (GHI)	G	H	I	4	
5 (JKL)	J	K	L	5	
6 (MNO)	M	N	O	6	
7 (PRS)	P	Q	R	S	7
8 (TUV)	T	U	V	8	
9 (WXY)	W	X	Y	Z	9
0	0				
*	*				
#	#				

3. When the letter or number you want is shown on the display, press **M+M** to locate the second letter or number.
4. Go back to step 2, and repeat the same procedures until the complete character name is displayed.
5. When an entry error is made, press **CLR** momentarily to erase the last character. If you press **CLR** more than a second, all characters on the readout will be erased.
6. To exit Alpha Mode, press **FNC** **M+M**.

- Notes:
1. If the next letter or number is assigned on the other key (not same key), you can display the next letter or number without pressing **M+M**.
 2. You must enter the phone number first, then apply the name. Entering a number after applying the name will erase its name.

To Store Name with Phone Number

1. Enter the phone number.
2. Press **FNC** **M+M** to set Alpha Mode.
3. Enter the name you need. (Refer to "To Enter Names using Alpha".)
4. Press **FNC** **RST**, then enter the memory address (01 through 99), to store the number with the name into memory.

Note: If you enter the phone number after entering the name, the name will be erased.

Example: To store the phone number 1234567890 with the name JACK into memory address 01.

1. Enter the phone number;

1 2 3 4 5 6 7 8 9 0

2. Set Alpha Mode; **FNC** **M+M**

3. Enter the Name;

5 2 M 2 2 5 5
(J) (A) (C) (K)

4. Store the Number; **FNC** **RST** 0 1

To Recall from Memory with Name

Recalling from the repertory memory with name is identical to standard repertory recall. When the number is recalled, the display will show the Alpha Name Tag as well as the stored phone number.

ALPHA SEARCH

This feature permits you to find a phone number stored in the memory by the first character of the Alpha Name Tag. This search can retrieve all entries beginning with the assigned initial character.

1. Press **FNC** **MA** to set the Alpha Mode.
2. Enter the initial character, by which you need to search the phone number.
3. Press **FIRST** **▲**. The display will show the first entry whose Name Tag begins with the assigned initial character, and which is stored in the lowest memory address. Display shows Name Tag, Memory Address and Phone Number.
4. Press **▲** or **▼**.
 - ▲** : Scroll memory address upward.
 - ▼** : Scroll memory address downward.

Example:

Operation	Display
FNC MA	B 0 0 0 - A l p h a
5	B 0 0 0 - A l p h a J
FIRST ▲	B 0 0 0 - (0 1) J A C K 1 2 3 4 5 6 7 8 9 0
▲	B 0 0 0 - (0 5) J O H N 0 9 8 7 6 5 4 3 2 1
▲	B 0 0 0 - (1 5) J A M E S 2 1 0 9 8 7 6 5 4 3
▼	
▲	B 0 0 0 - (9 9) J I M 1 0 9 8 7 6 5 4 3 2
▲	B 0 0 0 - (0 1) J A C K 1 2 3 4 5 6 7 8 9 0
▼	B 0 0 0 - (9 9) J I M 1 0 9 8 7 6 5 4 3 2

PLACING TELEPHONE CALLS

To Place a Call

1. Enter the phone number. The last 20 digits of the dialed number are displayed on the readout. Note: After 60sec., display will return to the 10-digit display mode.
2. If a dialing error is made, press **CLR**, then enter the phone number again. Pressing **CLR** momentarily (less than approx. 0.5 sec.) clears only the last digit.
3. Press **SEND**. The **INUSE** indicator will light. When the called party answers, proceed with your conversation.

If the Call Fails to Go Through

1. If you hear the "reorder" signal, press **END**, then if there were no dialing errors, press **SEND** for redial. (Redialing with digit keys is not necessary.)
2. If the "intercept" signal is heard, press **END**, then redial the correct number.

Automatic Redial (NAM Option)

If the feature of Automatic Redial is selected, your unit will automatically make seven attempts to reach the cell site when the first try is not successful. The **INUSE** indicator will stay on, but the speaker will be muted for thirty seconds. This is done so that you do not hear the reorder signals out of the speaker. If you need to terminate the automatic redial, press **END**.

Terminating a Call

Press **END** and the **INUSE** indicator will go out.

To Receive Calls

When the telephone receives an incoming call, press **SEND** to answer the call. The **INUSE** indicator will light.

Any Digit Key Answering

This feature permits you to answer an incoming call by pressing any of the digit keys on the keypad.

Alert Tone Selection

This feature permits you to select a most suitable alert tone among four options.

1. Press **FNG** **7** **2** to enter into Alert Tone Selection Mode.
The current Alert Tone Pattern will appear.
2. Press **#** or ***** to scroll four options of Alert Tones, and press **RST** to determine the Tone.
3. Select "OFF" to Mute Alert Tone, and the unit enters into Silent Alert. If Silent Alert is activated when the unit is powered up, **S.ALT** will appear on the readout for 10 seconds.

Silent Alert

If an incoming call is received in this mode, **CALL** will flash on the display and the Incoming Call Indicator (LED) will flash without an obtrusive audible ring signal.

Single "beep" at the beginning of call will allow the user to know a phone call is being received.

Automatic Answering

With this feature, the incoming call will be automatically connected for operation after two alert tones, and the **IN USE** indicator will light on the readout.

Then the unit is ready for conversation.

1. Press **FNG** **7** **1**.
The **AutoAnswer** will appear on the readout. The current mode will flash.
2. Press **1**, and Automatic Answering is activated.
If the Automatic Answering is activated when the unit is powered up, **A.Ans** will appear on the readout for 10 seconds.
3. Press **3**, and Automatic Answering is deactivated.
4. This feature will not function if the unit is in the Lock, Keypad Lock and Silent Alert.

Anti-fraud Security Feature

Your new Audiovox Cellular telephone has been engineered with the latest technology to help protect from the fraudulent use of your cellular telephone number.

Cellular fraud most often occurs by cellular thieves using electronic devices that can read your unique cellular phone number and your phone's electronic serial number (E.S.N.). This information can then be programmed into another phone for fraudulent use.

Certain cellular systems provide for an ANTI-FRAUD security feature to help protect the unauthorized use of your cellular telephone number. This feature utilizes a special personal identification number (PIN).

Should your cellular carrier offer this enhanced service, your new phone may be programmed with a PIN chosen by you. For your protection, you cannot make any outgoing calls until you have established your PIN. To establish your PIN, please contact your cellular service provider for specific instructions.

To place a call using the PIN security feature

1. Enter the number you are calling by either dialing the number or recalling the number from a specific memory location.
2. Press the **SEND** key as your call is being processed the word **SEND PIN** will appear in the display.
3. Press the **SEND** key again, your call will then be placed.

To turn the ANTI-FRAUD feature On/Off.

1. Press **FNG** **9** **2**.
The **PIN** will appear on the readout. The current mode will flash.
2. Press **1**, and PIN mode is activated.
3. Press **3**, and PIN mode is deactivated.

To change the PIN.

1. Press **FNG** **9** **2**.
The **PIN** will appear on the readout.
2. Press **0**, and PIN number is changed.
3. Enter the three-digit security code. Old number will appear on the readout.
4. Enter the new PIN number.
5. Press **RST**.

To place a call with PIN entry feature in Voice Mail Dialing.

1. Press the **MEM** key for more than 0.5 seconds. The last 10 digits of the number in memory address 91 will appear in the display. As your call is being processed, **SEND PIN** will appear in the display.
2. Press the **MEM** key again, your call will then be sent digitally to the cell site. After you hear the signal from the Operating Office, press **MA** "Voice Mail Access" key again. The second number in memory address 92 is sent with DTMF tones. You will monitor the tones through the loudspeaker. The third through fifth number in memory address 93 though 95 can be accessed sequentially in the same manner as above.

To Place a Call with a Number in the Memory

1. Press **RST**, then enter the memory address (01 through 99). The last 10 digits of the number will appear on the readout. If the number is longer than 10 digits, hold down the second digit of the memory address (after pressing **RST**) to see the prefix.
Note: See "To Recall a Number from Memory" and "To Review the Prefix" for more details.
2. Press **SEND**. The **IN USE** indicator will light as the call is placed.

Speed Dialing

This feature permits you to place a call from the stored memory locations without using the recall **RST** key. Speed dialing is a quick method of placing calls from memory.

1. Enter the one or two digits of memory address (1 through 9 and 10 through 99).
2. Press **SEND**. The last 10 digits of the phone number will appear on the readout, and the **IN USE** indicator will light.

Last Three Number Redial

This feature permits you to redial any of the last three phone numbers you attempted to call.

Numbers will be stored in memory only if **SEND** key is pressed.

Note: If same telephone number is attempted more than once phone will only utilize one memory location.

1. Press **RST** ***** **#**. The last phone number is displayed on the readout.

Example:

B	0	0	0	-	-	(#1)
J	A	C	K	-	-	-
1	2	3	4	5	6	7
8	9	0	-	-	-	-

2. Press **▲** or **▼**, the scrolled number is displayed on the readout.
▲ : Scroll upward (with roll back to #1)
▼ : Scroll downward (with roll up to #3)
3. Press **SEND** to send a displayed number.
Note: To clear the stored number, press **CLR**, then **SEND** three times.

Programmable Emergency Call (NAM Option)

This feature permits you to place a call to 3 emergency numbers (maximum of 7 digits) even if your telephone has been set to the locked, keypad locked or restricted modes.

The three emergency numbers must be pre-programmed in the NAM.

Note: 911 is preset emergency number. (you may change this number if you wish.)

Operation in Lock Mode or Keypad Lock Mode

1. Enter the emergency call number (911);
9 **1** **1**
("911" does not indicate, but the **LOCK** or **KeypadLock** will appear on the readout.)
2. Press **SEND**, the **IN USE** indicator will light.
3. To terminate the call, press **END**. (The **IN USE** indicator will go out.)

Operation in Call Restriction Mode

The operation and display are the same as in the normal mode.

One Touch Emergency Call

This feature permits you to place a call to an emergency number by a single key stroke, even when the unit is in lock mode. You can deactivate this feature to prevent unintentional call by mistake.

1. Press key **1** for more than 2 seconds. The first emergency number that is pre-programmed in the NAM will be displayed, and **IN USE** indicator will light as a call is placed. The factory pre-set number is 911.
2. Press **FNC** **9** **1**.
The **1 touch Emergency** will appear on the readout.

3. Enter the three-digit security code.
The current mode will flash.
4. Press **1**, and One Touch Emergency Call is activated.
5. Press **3^{OFF}**, and One Touch Emergency Call is deactivated.
6. This feature will not function if the unit is in the Keypad Lock.

To Mute a Phone Conversation

1. Press **FNC** **3^{DEC}**. **Mute** will appear on the readout. The transmit audio will be muted and the receive audio will be heard from the receiver. The mute (or hold) feature will permit you to converse privately with a passenger during a call.
2. To return to normal conversation:
Press **FNC** **3^{UNM}** again.
3. Mute is reset when the call is terminated.

VOICE MAIL DIALING

This feature permits you to access, through telephone lines, a computer system and send DTMF number codes in sequence. Up to five numbers can be stored and are sequentially accessed with one touch of the "Voice Mail Access" key. The first number is sent in digital form to the cell site, then up to four other numbers are sent with DTMF signaling.

To Store Numbers

Store the numbers to be linked into the special memory address 91 through 95. Each number should be within 32 digits.

To Place a Call

Press **MMA** "Voice Mail Access" key for approx. 0.5sec. The first number in memory address 91 will appear on the readout and will be sent digitally to the cell site. After you hear the signal from the Operating Office, press **MMA** "Voice Mail Access" key again. The second number is memory address 92 will appear on the readout and is sent with DTMF tones. You will monitor the tones through the loudspeaker. The third through fifth number in memory address 93 through 95 can be accessed sequentially in the same manner as above.

CALL RESTRICTION (NAM OPTION)

This feature permits you to impose various kinds of restrictions on Outgoing Calls.

To Set Call Restricted Mode

1. Press **FNC** **9^{NOV}** **4^{UNM}**.
The **Restrict** will appear on the readout.
2. Enter the three-digit security code.
The current mode will flash.
You can change the current mode by pressing **#** or ***¹**.
: Scroll upward.
***¹** : Scroll downward.

11 digits : Only phone numbers having 11 digits or less are accepted. Operator assisted dialing is prohibited.

7 digits : Only phone numbers having 7 digits or less are accepted. Operator assisted dialing is prohibited.

Operator : Operator assisted dialing (0 Origination) is prohibited.

Recall 1-9: No phone calls can be placed except for repertory dialing from memory address 01 to 09. However, programmable emergency call will be available.

OFF : No restriction.

3. Press **RST**.

Note: (1) When in the "Recall 1-9" mode, number storage into the memory will not be permitted.

- (2) In the restriction mode, a short beep tone will be heard to inform you of the improper operation, and the word **Restricted** will be shown on the readout.

END-TO-END SIGNALING

This feature permits you to utilize additional phone services, such as accessing an alternate long distance network, signaling pager, or banking by phone etc.

For these services the signaling should be in DTMF (Touch Tone™). The following two features will make it easier to send in DTMF codes.

Note: When you use this feature with a secret number, the number must be previously stored in a memory address. (Refer to "To Store the Secret Number".)

Touch Tone™ from Memory

DTMF signaling by repertory dialing is available while engaged in a telephone conversation.

1. Press **(RST)**, then enter the repertory memory address (01 through 99).

The last 10 digits of the number will appear on the readout.

Note: However, if the memory address entered has been set as a secret memory, **Secret** will be displayed on the readout instead of the number.

2. Press **(SEND)**. Then DTMF signaling will be placed and the DTMF tone can be monitored through the speaker.

Note: Continuous DTMF from keypad can be manually dialed as well to access answering machines when engaged in a telephone call.

Link Dialing

This feature permits you to link a series of numbers to be sent in DTMF Signaling. The linked numbers can be programmed in Repertory Memory. The first set of numbers will be sent in Digital Signaling to the cell site, and the rest of the numbers will be sent in DTMF Signaling individually by pressing **(SEND)** key each time.

Notes:(1) The maximum length of each linked number is 32 digits including Linking Mark "=",

- (2) Total length of the whole linked numbers should be up to 80 digits.
- (3) The linked numbers of more than 32 digits can be stored only in the Repertory Memory 96 through 99.

Example: To access the alternate long distance service using a secret number, you should call your long distance service office first, and enter your ID number, then the phone number to be placed.

• To Link Number/To Store Linked Numbers in Memory

1. Recall the phone number of the long distance service office.
Press **(RST)**, then enter the memory address (01 through 99).

1	7	4	6	3	4	7	9	=
---	---	---	---	---	---	---	---	---

2. Press **(FNC)** **(*)**.
Linking Mark "=" will be added at the end of the number.

1	7	4	6	3	4	7	9	=
---	---	---	---	---	---	---	---	---

3. Enter the ID Number.
Press **(1)** **(2)** **(3)**.

									7
4	6	3	4	7	9	=	1	2	3

4. Press **(FNC)** **(*)**.

									7	4
6	3	4	7	9	=	1	2	3	=	

5. Enter the phone number.
Press **(1)** **(2)** **(3)** **(4)** **(5)** **(6)** **(7)** **(8)** **(9)** **(0)**.

6	3	4	7	9	=	1	2	3	=
1	2	3	4	5	6	7	8	9	0

6. Press **(FNC)** **(RST)** **(1)** **(5)**.

B	0	0	0	-	-	-	-	-	(15)
1	2	3	4	5	6	7	8	9	0

• To Place Linked Numbers

1. Press **(RST)** **(1)** **(5)**.

B	0	0	0	-	-	-	-	-	(15)
1	2	3	4	5	6	7	8	9	0

2. Press **(SEND)**. The **INUSE** indicator will light as the call is placed. 1st. Number will appear on the readout.

1	7	4	6	3	4	7	9	=
---	---	---	---	---	---	---	---	---

3. After you received an answer from the long distance service office, press **(SEND)** again. The DTMF signal will be placed and the DTMF tone of your ID number can be monitored through the speaker.
2nd. Number will appear on the readout.

									1	2	3	=
--	--	--	--	--	--	--	--	--	---	---	---	---

4. If your ID number is accepted, the long distance service office will answer again, so press **SEND**.

Then the long distance call will be placed and the DTMF tone can be monitored through the speaker.

3rd. Number will appear on the readout.

1234567890

Note: The number linked can also be stored in secret memory as stated in the "Secret Memory".

1. When a set of linked numbers which includes a secret number has been stored in memory address 01 through 99, enter the three-digit security code, press **FRST**, memory address (01 through 99), and then **SEND** to place the call. The first linked number will be called as shown in step 2 above.

If the secret number is not included in the linked number, you need not enter the three-digit security code in the above operation.

2. To complete the call, continue operations as shown in the steps 3 and 4.

SCRATCH-PAD DIALING

This feature permits you to enter a number to be redialed (or store a number in memory) while engaged in a conversation.

SCRATCH-PAD DIALING WITHOUT KEYING TONES

This feature permits you to activate scratch-pad memory without annoying key tones over the circuit.

1. Press **FNC** **4**. **Tone** will appear on the readout. The Microphone circuit will remain active, but the tones will not be heard.
2. Enter the phone number. If necessary, press **FNC** **FRST**, then enter the memory address.
3. To active the tones, press **FNC** **4** again.

CALL TIME DISPLAY

This feature automatically records the elapsed time per conversation. The talk time of the last call, cumulative outgoing call time and cumulative talk time can be displayed on the readout. The timers can also be cleared if necessary.

With beep tones you can be notified of the approximate talk time (NAM Option) in approximately 60 seconds increments.

To Display the Talk Time of the Last Call

1. Press **FNC** **6** **1**.
The talk time of the last call will be displayed on the readout for 10 seconds.
While in a conversation, the talk time of a call in progress will be displayed, and updated each second. The display format is as follows.
01m25 ... 1 min. and 25 sec.

To Display the Outgoing Call Timer Only

1. Press **FNC** **6** **2**.
The outgoing call time will be displayed on the readout for 10 seconds.
12m ...12 min.

To Display the Cumulative Talk Time

1. Press **FNC** **6** **3**.
The cumulative talk time will be displayed on the readout in minute format for 10 seconds.
18m ...18 min.

To Clear the Timer

1. Press **FNC** **6** **4**, then enter the three-digit security code.
The timers will be cleared, and the count for the cumulative talk time and the cumulative outgoing call time will start from zero.
Timer Cleared will be displayed on the readout for 10 seconds.

One Minute Beep (NAM Option)

During conversation, you can be notified of the approximate talk time by tones for the first five minutes. (a short monotone signal will sound every minute and a double beep tone will be heard after approximately 5 minutes.)

SID MANAGEMENT (NAM OPTION)

This feature enables you (by NAM option) to take advantage of a family of SID groups. This is a group of cellular systems in cities that your carrier owns or has special billing arrangements with. Your close family SID's (like brothers and sisters) will be billed at the same rate as your home billing and will be indicated as "Home" (i.e. both **NO SVC** and **ROAM** are off) on your display. More distant family SID's (like cousins) will be billed at a preferred rate. Your phone will display solid **ROAM** when using these groups of systems in their cities. When flashing **ROAM** is displayed, you are using a SID system that is not included in the NAM assigned groups.

If your display indicates flashing **NO SVC**, you will need to change your A/B switch selection or, please refer to Multiple City Registration to change phone registration to enable you to make a call.

If in question as to what SID (system identification) you are using, push **FNC** **8** **2** to display the current SID.

A/B SYSTEM SELECTION

This feature permits you to select the system you need to use. The system that you are registered with is the preferred system, and your home system.

When you turn the unit on, the unit remembers the last position of the A/B system selected, and will start to scan the radio frequency channels of that selection.

1. Press **FNC** **8** **1**.
The **A/B Switch** will appear on the readout. The current mode will appear.
2. You can change the current mode by pressing **#** or *****.
 - #** : Scroll upward
 - *** : Scroll downward
 - **Standard Mode**
The unit will scan the preferred system channels. If unable to find an acceptable preferred channel, the unit switches to scan the non-preferred channels.
 - **Home Only Mode**
You can place or receive calls only within your home area.
 - **Preferred System Only Mode**
The unit will scan the preferred system only and prevents switching over to the non-preferred system.
 - **Non-preferred System Only Mode**
The unit will scan the non-preferred system only.
3. Press **FST**.
The **Selected** will appear on the readout.

MULTIPLE CITY REGISTRATION

Some cellular users find it beneficial to register their phone in multiple cities, rather than rely on "roam". The multiple city registration feature permits you to reprogram from the telephone unit, the different phone numbers for the cities in which you are registered. Each programmed phone number will be designated as your home system.

Press **FNC** **8** **3**, and enter the new system ID number (5 digits) followed by the corresponding phone number (10 digits). Please include your area code. You must register your unit with the carrier in order to get both the system ID number and your phone number.

Press **RST**. Your new phone number will be displayed on the readout.

- Note: (1) System ID number and phone number can not be programmed during a call.
 (2) Calls are placed or received using only the programmed phone number, in use at the time of call.

LAST RESCAN SID INDICATOR

This feature permits you to recall the last system identification accessed by your phone.

Press **FNC** **8** **2**.

The last rescan SID is displayed on the readout for 10sec. The display format is as follows:

F	8	2
R	e	s	c	a	n	S	I	D	.
.	0	0	0	2
.

If the **NO SVC** indicator is on, the display will show as follows:

F	8	2
R	e	s	c	a	n	S	I	D	.
.
.

RADIO FREQUENCY (RF) CHANNEL INDICATOR

If necessary, you can see the RF channel status in which your unit is operating.

1. Press **FNC** **8** **4**.

The RF channel number, RSSI, SAT color code, and transmitting power level will be displayed on the readout. The display format is as follows:

F	8	4
R	F	.	.	C	1	2	3	.	.
R	1	8	7	S	0	.	P	2	.
.

C123....	RF channel number
R187....	RSSI value
S0....	SAT color code
P2....	Transmitting power level

2. The display will remain on the readout until you manually reset it by pressing key **CLR**.

AUTOMATIC CALLS IN ABSENCE INDICATOR

This feature indicates the number of unanswered incoming calls. If incoming calls are unanswered, the Incoming Call Indicator lights intermittently and the unit will indicate the following.

Called XX

XX is the number of calls (01 to 99) missed. Depressing any key (other than the Power Key) will clear the number of calls indicated in Display and the Incoming Call Indicator will no longer light intermittently. However, the number of calls will remain if the unit is turned off.

FUNCTION MENU

This feature permits you the following functions.

1. To review the key operation.
2. Set or change the function status.
3. To confirm the current function status (The current mode will flash).

Press **[FNC]** for about one second.

Scroll the menu up or down, using the **[▲]** or **[▼]** key respectively.

The display information will appear as follows.

Example:

F71
AutoAnswer
1:ON 3:OFF

 → Key Sequence
 → Function
 → Current Status/Setting

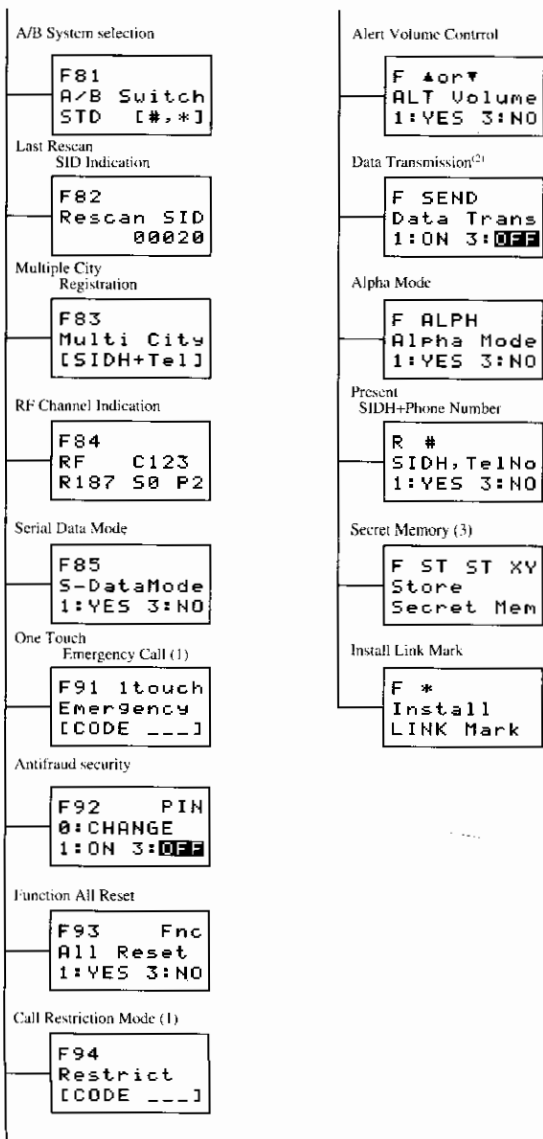
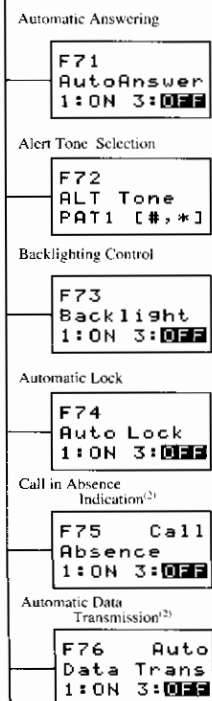
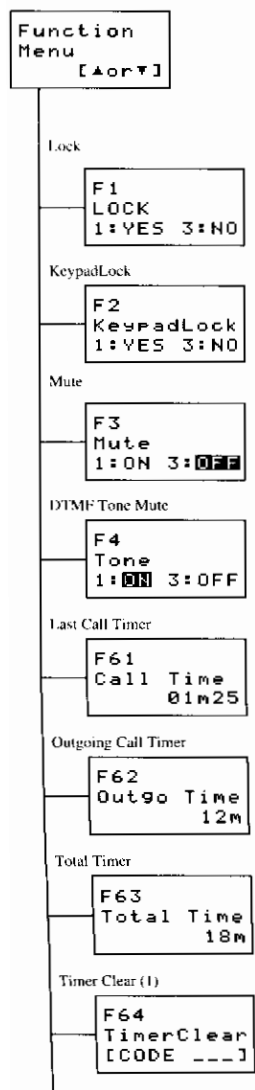

- Note: (1) ___ = Three-digit Security Code
 (2) These features are available only when the unit is connected with a Car Kit (option).
 (3) XY = Repertory Memory Address. (01 through 99)

SERIAL DATA MODE

When the phone is placed in SERIAL DATA MODE, the **S-Data Mode** is displayed and the keypad becomes non-functional (except for the power on/off key). This mode can be activated by pressing **FN** **8** **5**.

Press **1**, and SERIAL DATA MODE is activated. Press **3**, and SERIAL DATA MODE is deactivated.

While in this mode, an automated interface device (optional) can be connected to the handset. This will allow a laptop computer or fax machine to be connected for data transmission as well as provide the capability of connecting "phone line" based equipment (standard phone, answering machine, TDD devices for the hearing impaired, etc.) to the handset.

To deactivate this feature press **PNR** key to turn the power off.

IMPORTANT SAFETY INFORMATION

Please read and follow these cautions carefully. TURN OFF your unit in an explosive atmosphere (near a fuel pump, blasting area, etc.).

DO NOT dial when your unit is moving in states where this action is illegal (this is not a prudent practice, even where it is legal).

DO NOT permit untrained personnel to operate the unit.

DO NOT use unauthorized accessories.

DO NOT disassemble the phone or its accessories; If service or repair is required, return unit to an authorized Audiovox cellular service center. If unit is disassembled, the risk of electric shock or fire may result.

DO NOT open the battery case. If the battery is accidentally broken, avoid skin contact with the internal chemical contents. If there is skin contact, wash the affected area immediately and seek medical advice.

FUNCTION ALL RESET

This feature permits you to initialize the User-Programmable functions.

Press **FN** **9** **3** to enter Function All Reset Mode, and enter your three digit security code. If the correct security code was entered, the following functions will be reset to the initial setting.

Functions	Initial Setting	
DTMF Tone	ON	
Automatic Answering	OFF	
Call in Absence (Safety Timer)	OFF	
Auto DATA Transmission	OFF	
Backlighting Control	Portable Use	OFF
	With Car Kit	ON
A/B System Selection	STD	
Automatic Lock	OFF	
Call Restriction Mode	OFF	
OneTouch Emergency Call	ON	
PIN	OFF	
Alert Tone Selection	PAT1	

WARNING

The following offences can be punished by fine, imprisonment, or both:

- Using obscene, indecent, or profane language.
- Using the unit to give off false distress calls.
- Wiretapping or otherwise intercepting a telephone call, unless that person has first obtained the consent of the parties participating in the call.
- Making anonymous calls to annoy, harass, or molest other people.
- Charging to an account without authorization to avoid payment for service.
- Refusing to yield a party line when informed that it is needed for an emergency call (It is also unlawful to take over a party line by stating falsely that it is needed for an emergency).

36 MONTH LIMITED WARRANTY

AUDIOVOX CORPORATION (the Company), warrants to the original retail purchaser of this Audiovox Handheld Portable Cellular Telephone, that should this product or any part thereof (except the items listed below), under normal use and conditions, be proven defective in material or workmanship within the first thirty-six (36) month period from the date of purchase, such defect(s) will be repaired or replaced (with new or rebuilt parts) at the Company's option, without charge for parts or labor directly related to the defect(s).

The keypad and display are similarly warranted for twelve (12) months from date of purchase.

The accessories consisting of the antenna and rechargeable battery pack, desk top battery charger, wrist strap are similarly warranted for only ninety (90) days from original purchase.

This Warranty does not apply to batteries, fuses, or costs incurred for testing or checking, or to any product or part hereof which has suffered through alteration, serial number defacement, improper installation, excessive temperature or humidity, environmental conditions, mishandling, misuse, neglect or accident. This Warranty is not assignable or transferable.

To obtain repairs or replacement within the terms of this Warranty, the product should be delivered with proof of warranty coverage, specification of defect(s), transportation prepaid, to the Company at the address shown below. For TRAVELERS WARRANTY SERVICE.

Call toll free to (800) 229-1235 (in N.Y. State, (516) 233-3410) for reference to an Authorized Warranty Station in your area.

THE EXTENT OF THE COMPANY'S LIABILITY UNDER THIS WARRANTY IS LIMITED TO THE REPAIR OR REPLACEMENT PROVIDED ABOVE AND, IN NO EVENT, SHALL THE COMPANY'S LIABILITY EXCEED THE PURCHASE PRICE PAID BY PURCHASER FOR THE PRODUCT.

The Company disclaims liability for geographic coverage, inadequate signal to antenna, communications range or operation of the Cellular System as a whole.

ANY IMPLIED WARRANTIES, INCLUDING ANY IMPLIED WARRANTY OF MERCHANTABILITY SHALL BE LIMITED TO THE DURATION OF THIS WRITTEN WARRANTY. ANY ACTION FOR BREACH OF ANY WARRANTY HEREUNDER INCLUDING ANY IMPLIED WARRANTY OF MERCHANTABILITY MUST BE BROUGHT WITHIN A PERIOD OF 48 MONTHS FROM DATE OF ORIGINAL PURCHASE. IN NO CASE SHALL THE COMPANY BE LIABLE FOR ANY CONSEQUENTIAL OR INCIDENTAL DAMAGES FOR BREACH OF THIS OR ANY OTHER WARRANTY, EXPRESS OR IMPLIED, WHATSOEVER.

No person or representative is authorized to assume for the Company any liability other than expressed herein in connection with the sale of this product.

Some states do not allow limitations on how long an implied warranty lasts or the exclusion or limitation of incidental or consequential damage so the above limitation or exclusions may not apply to you. This Warranty gives you specific legal rights, and you may also have other rights which vary from state to state.

IN U.S.A.:

185 Oser Avenue, Hauppauge,
New York 11788
(516) 233-3300

IN CANADA:

#101-405 Britania Road East,
Mississauga, Ontario, Canada L4Z3E6
(905) 712-9299

ACCESSORY CATALOG



DTC-800
Desk Top Charger

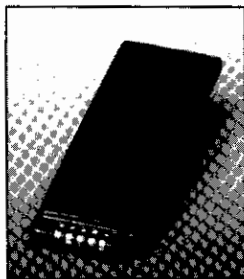

BTE-800
Extended Life Battery
(Nickel Metal Hydride)



HF-800
Hands-Free/RJ-11
Car Adapter Kit
(For MVX-800/850
Series)

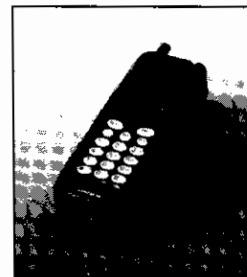

LB-800
Leather Carrying Case
(For MVX-800/850
Series)

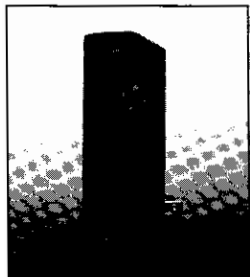

TRC-800
Travel Charger

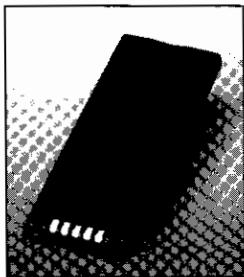

BTR-800
Standard Life Battery
(Nickel Metal Hydride)

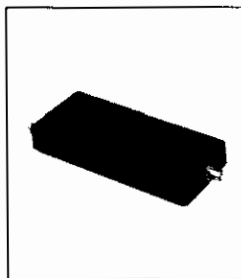

PBK-800
3 Watt Power Booster
(For use with HF-800)

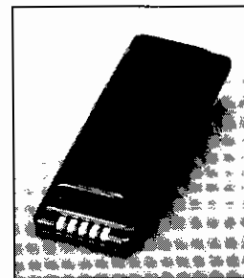

BTX-800
High Capacity Battery
(Nickel Metal Hydride)

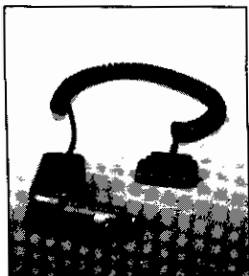

CLC-800
Cigarette Lighter
Charger

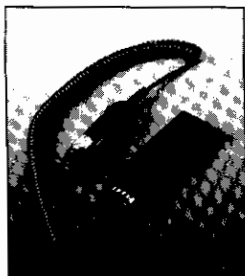

CLA-800
Battery Eliminator

RC-800 (not shown)
Rapid Charger
(For use with BTE-800/BTR-800 or BTX-800)

STI80 (not shown)
Standard Telephone Interface

PROTECT YOUR WARRANTY

Read your Warranty carefully, with the special consideration to paragraph seven of the Limited Warranty for your unit.

“Warranty does not apply to...or to any product or part thereof which has suffered through alteration... mishandling, misuse, neglect, or accident”.

Many companies are making look-alike accessories and in some cases, promoting that their product is equal to or better than the Audiovox product. Be careful. Some of these products may not be compatible for use with your Audiovox product and may damage the unit or cause it to malfunction. If service is required on your unit, and it is determined that a non-Audiovox accessory has created the problem with your unit, the Warranty will not apply. In addition, if the unit has already suffered irreversible damage by reason of a non-compatible accessory, the Warranty will be voided. To protect your Warranty, use only compatible accessories which cannot damage or interfere with the functioning of your Audiovox product.



Free Manuals Download Website

<http://myh66.com>

<http://usermanuals.us>

<http://www.somanuals.com>

<http://www.4manuals.cc>

<http://www.manual-lib.com>

<http://www.404manual.com>

<http://www.luxmanual.com>

<http://aubethermostatmanual.com>

Golf course search by state

<http://golfingnear.com>

Email search by domain

<http://emailbydomain.com>

Auto manuals search

<http://auto.somanuals.com>

TV manuals search

<http://tv.somanuals.com>