

AUDIOVOX
Communications Corp.
185 OSER AVE., HAUPPAUGE, NY 11788

OPERATING INSTRUCTIONS



**HANDHELD PORTABLE CELLULAR TELEPHONE
COMPLETE WITH CHARGER AND BATTERY**

MVX501

MVX501 HANDHELD CELLULAR TELEPHONE

Congratulations. By choosing the MVX501, you have joined the millions of satisfied customers who are enjoying the benefits and quality performance that only an Audiovox Cellular Telephone can provide.

Your Audiovox Portable Cellular Telephone has been designed to the highest standards of quality and manufacturing excellence to fulfill both your personal and business requirements. Fully charged standard Ni-Cad battery provides approximately 80 minutes of continuous talk time or approximately 12 hours of standby time.

The Audiovox MVX501 is packed with advanced features like Programmable One Touch Emergency Dialing, Anti-Fraud Security Features, Automatic Call Retry, a Signal Strength Indicator and Battery Level Indication.

Optional Accessories include; an Extended Life Nickel Metal Hydride Battery, a Slim Profile Nickel Metal Hydride Battery, a Hands free Mobile Kit with provisions for external antenna and a 3 watt RF Power Booster. A Desk Top Charger, Cigarette Lighter Charger, Battery Eliminator and a Leather Carrying Case are also available.

And of course, your new Audiovox MVX501 comes with something only an Audiovox phone can provide. The proven reliability that has made Audiovox one of the world's leading suppliers of cellular communications equipment.

The following pages describe your phone's functions and will help you make the most efficient use of this wonderful communications tool.

Following codes can be obtained through your authorized Audiovox dealer.

- a. 3-digit Initial Lock (Unlock) Code
- b. 3-digit Initial Call Restriction Code
- c. 2-digit Initial Call Counter Code
- d. 2-digit Initial Call Timer Code

Keep these codes in a safe place!

TABLE OF CONTENTS

INTRODUCTION	3
Safety Information for Wireless Handheld Phones	3
Features	7
Key/Display Names and Functions	8
Wrist Strap (Optional) Attachment	10
BATTERY OPERATION	10
Battery Insertion/Removal	10
Battery Charging	11
Battery Level Indication	12
Low Battery Warning	12
BASIC OPERATION	13
Turning your Phone ON and OFF	13
Backlighting	13
Antenna Position	13
Display Own Telephone Number	13
Display Own System ID	13
Placing Calls	13
Call-in Progress Protection	14
Receiving Calls	14
Call in Absence Indication	14
Redialing Functions	14
Last Three Numbers Dialed	14
Automatic Redial (Programmable Option)	15
MIC Mute During Conversation	15
Volume Adjustment	15
Earpiece Volume	15
Alert Volume	15
Keypad Tone Volume	15
ENHANCED OPERATION	16
Locking/Unlocking your Phone	16
Locking your Phone	16
Changing the Unlock Code	16
Automatic Lock (Programmable Option)	17
Keypad Disable Function in Handsfree Mode (Programmable Option)	17
Storing in the Memory	18
Manual Storage	18
Automatic Storage	18
Storage After Vacant Memory Location Search	19
Editing the Telephone Numbers	20
Memory Search	20
Recalling Numbers from Memory	20
Memory Dialing	20
Dialing after Telephone Number Search	21
Speed Dialing	21

Programmable One Touch Emergency Call	22
Placing One Touch Emergency Call	22
One Touch Emergency Call ON/OFF	22
Programming a New Emergency Number	22
Scratch Pad Memory	23
Storing Numbers in the Scratch Pad Memory	23
Dialing Numbers in the Scratch Pad Memory	23
Emergency and Priority Dialing	23
Storing the Emergency and Priority Number	23
Dialing the Emergency and Priority Number	23

EXTENDED FEATURES AND FUNCTIONS 24

Call Restriction	24
To Activate Call Restriction	24
To Change the Call Restriction Code	24
Keypad (DTMF) Tones	25
Keypad (DTMF) Tones Duration Selection	25
Keypad (DTMF) Tones Mute during conversation	25
Sending DTMF Tones During a Call	25
Timer and Counter Functions	25
Elapsed Time Display	25
Outgoing Call Timer	26
Cumulative Call Timer	26
Temporary Accumulated Call Counter	26
Outgoing Call Counter	27
Accumulated Call Counter	27
To Change the Call Timer/Call Counter Codes	27
Call Time Warning Tone	28
SID Management (Programmable Option)	28
A/B System Selection	28
Multiple City Registration	29
Current SID, Channel and RSSI Level Display	30
ESN (Electronic Serial Number) Display	30
Anti Fraud Security Feature (PIN Feature)	30
Enhanced Feature Operation	31
Audiovox Accessory Catalog	36

GENERAL SPECIFICATIONS 40

TABLE OF KEY OPERATION 41

12 MONTH LIMITED WARRANTY 44

INDEX

INTRODUCTION

First introduced in 1984, the handheld portable cellular telephone is one of the most exciting and innovative electronic products ever developed. With it you can stay in contact with your office, your home, emergency services, and others.

SAFETY INFORMATION FOR WIRELESS HANDHELD PHONES

READ THIS INFORMATION BEFORE USING YOUR HANDHELD PORTABLE CELLULAR TELEPHONE

EXPOSURE TO RADIO FREQUENCY SIGNALS

Your wireless handheld portable telephone is a low power radio transmitter and receiver. When it is ON, it receives and also sends out radio frequency (RF) signals.

In August, 1996, the Federal Communications Commission (FCC) adopted RF exposure guidelines with safety levels for hand-held wireless phones. Those guidelines are consistent with the safety standards previously set by both U.S. and international standards bodies:

ANSI C95.1 (1992)*

NCRP Report 86 (1986)*

ICNIRP (1996)*

- American National Standards Institute; National Council on Radiation Protection and Measurements; International Commission on Non-Ionizing Radiation Protection

Those standards were based on comprehensive and periodic evaluations of the relevant scientific literature. For example, over 120 scientists, engineers, and physicians from universities, government health agencies, and industry reviewed the available body of research to develop the ANSI Standard (C95.1).

The design of your phone complies with the FCC guidelines (and those standards).

ANTENNA CARE

Use only the supplied or an approved replacement antenna. Unauthorized antennas, modifications, or attachments could damage the phone and may violate FCC regulations.

PHONE OPERATION

NORMAL POSITION: Hold the phone as you would any other telephone with the antenna pointed up and over your shoulder.

TIPS ON EFFICIENT OPERATION : For your phone to operate most efficiently:

- Extend your antenna fully.
- Do not touch the antenna unnecessarily when the phone is in use. Contact with the antenna affects call quality and may cause the phone to operate at a higher power level than otherwise needed.

DRIVING

Check the laws and regulations on the use of wireless telephones in the areas where you drive. Always obey them. Also, if using your phone while driving, please:

- Give full attention to driving - - driving safely is your first responsibility.
- Use hands-free operation, if available.
- Pull off the road and park before making or answering a call if driving conditions so require.

ELECTRONIC DEVICES

Most modern electronic equipment is shielded from RF signals. However, certain electronic equipment may not be shielded against the RF signals from your wireless phone.

PACEMAKERS

The Health Industry Manufacturers Association recommends that a minimum separation of six (6") inches be maintained between a handheld wireless phone and a pacemaker to avoid potential interference with the pacemaker. These recommendations are consistent with the independent research by and recommendations of Wireless Technology Research.

Persons with pacemakers:

- Should ALWAYS keep the phone more than six inches from their pacemaker when the phone is turned ON.
- Should not carry the phone in a breast pocket.
- Should use the ear opposite the pacemaker to minimize the potential for interference.
- If you have any reason to suspect that interference is taking place, turn your phone OFF immediately.

HEARING AIDS

Some digital wireless phones may interfere with some hearing aids. In the events of such interference, you may want to consult your service provider or call the customer service line to discuss alternatives.

OTHER MEDICAL DEVICES

If you use any other personal medical device, consult the manufacturer of your device to determine if they are adequately shielded from external RF energy. Your physician may be able to assist you in obtaining this information.

Turn your phone OFF in health care facilities when any regulations posted in these areas instruct you to do so. Hospitals or health care facilities may be using equipment that could be sensitive to external RF energy.

VEHICLES

RF signals may affect improperly installed or inadequately shielded electronic systems in motor vehicles. Check with the manufacturer or its representative regarding your vehicle. You should also consult the manufacturer of any equipment that has been added to your vehicle.

POSTED FACILITIES

Turn your phone OFF in any facility where posted notices so require.

AIRCRAFT

FCC regulations prohibit using your phone while in the air. Switch OFF your phone before boarding an aircraft.

BLASTING AREAS

To avoid interfering with blasting operations, turn your phone OFF when in a "blasting area" or in areas posted: "**Turn off two-way radio**". Obey all signs and instructions.

POTENTIALLY EXPLOSIVE ATMOSPHERES

Turn your phone OFF when in any area with a potentially explosive atmosphere and obey all signs and instructions. Sparks in such areas could cause an explosion or fire resulting in bodily injury or even death.

Areas with a potentially explosive atmosphere are often but not always clearly marked. They include fueling areas such as gasoline stations; below deck on boats; fuel or chemical

transfer or storage facilities; vehicles using liquefied petroleum gas (such as propane or butane); areas where the air contains chemicals or particles, such as grain, dust or metal powders; and any other area where you would normally be advised to turn off your vehicle engine.

FOR VEHICLES EQUIPPED WITH AN AIR BAG

An air bag inflates with great force. **DO NOT** place objects, including both installed or portable wireless equipment, in the area over the air bag or in the air bag deployment area. If in-vehicle wireless equipment is improperly installed and the air bag inflates, serious injury could result.

FEATURES

- SID management (programmable option)
- Multiple city registration
- Easy to read LCD display with status indicators
- Back-lit keypad and LCD display
- Microphone mute control
- Priority/emergency calling with automatic retry
- 9 number speed dialing
- Automatic redial (programmable option)
- 25 memory locations
- 3 location scratch pad, with automatic scroll
- Vacant memory location search
- Automatic entry into vacant memory location
- Phone number search
- Programmable one touch emergency call
- Last 3 number dialed memory
- Call in progress protection
- Call time warning tone
- DTMF tone dialing from memory
- DTMF keypad mute
- DTMF extended tone dialing
- A/B system selection
- Current SID, RF channel and RSSI level display
- Automatic self diagnostics
- Electronic serial number display (own)
- Telephone number display (own)
- System ID display (own)
- 6 function call timer
- Anti-Fraud PIN Entry
- Automatic Lock (programmable option)
- Keypad Disable in handsfree mode (programmable option)
- Battery level indication

This cellular telephone is also capable of supporting the following optional network services.

- 1) Caller ID
- 2) Voice Mail Notification
- 3) Short Messaging Service

Note: Your cellular service provider may use different terminology when referring to the enhanced features listed above. Please check with your cellular service provider for an explanation and availability of these enhanced features.

KEY/DISPLAY NAMES AND FUNCTIONS

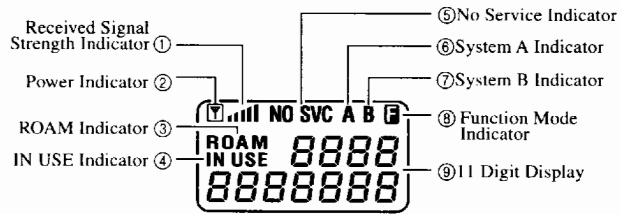

- ① Received Signal Strength Indicator constantly displays the signal strength represented by the number of bars.
 - ② lights when your phone is powered up. flashes when your battery is charged.
 - ③ **ROAM** lights when receiving services other than a registered home system.
 - ④ **IN USE** lights when a call is in progress.
 - ⑤ **NO SVC** lights when your phone is out of cellular service.
 - ⑥ **A** lights when the system A (non-wireline) is selected.
 - ⑦ **B** lights when the system B (wireline) is selected.
- Note: A B** lights when standard mode is selected.

- ⑧ lights when **FNC** is pressed to select extended functions, etc.
- ⑨ 11-digit display shows the telephone number dialed, etc.
- ⑩ **SEND** initiates and answers a call.
- ⑪ Up/Down keys and adjusts the alert, earpiece and keypad tones. and are also used to select ON/OFF setting and scroll.
- ⑫ **1** (Programmable One Touch Emergency Key) places a call to the programmed emergency number by a single key stroke.
- ⑬ Digit keys enter telephone numbers, etc.
- ⑭ **END** terminates a call.
- ⑮ **PWR** (Power) turns your phone on and off.
- ⑯ **CLR** (Clear) clears the digit(s) from the display.
- ⑰ **R/S** (Recall/Store) recalls telephone numbers from the memory. Also used to store telephone numbers in the memory.
- ⑱ **FNC** (Function) is used with digit keys to allow operation of extended functions, etc.

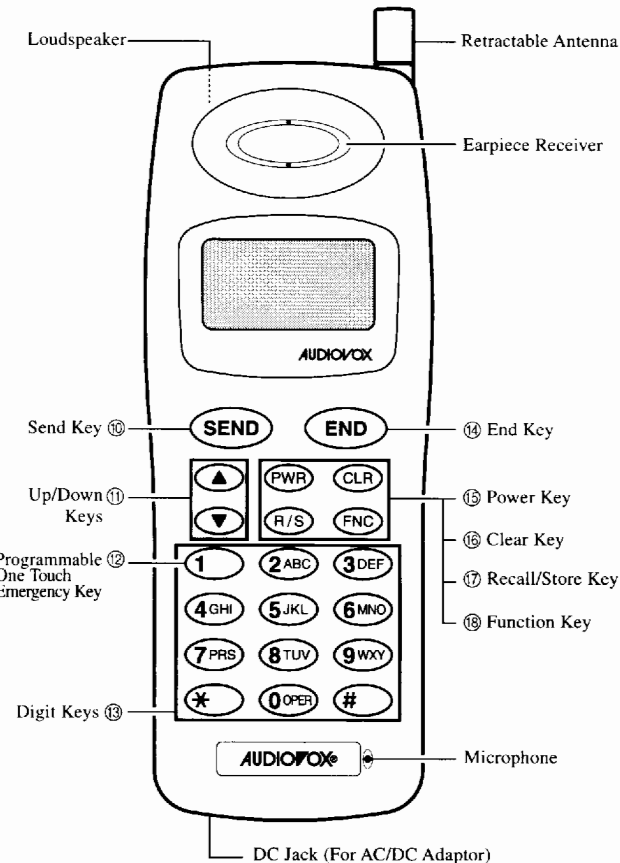

WRIST STRAP (OPTIONAL) ATTACHMENT

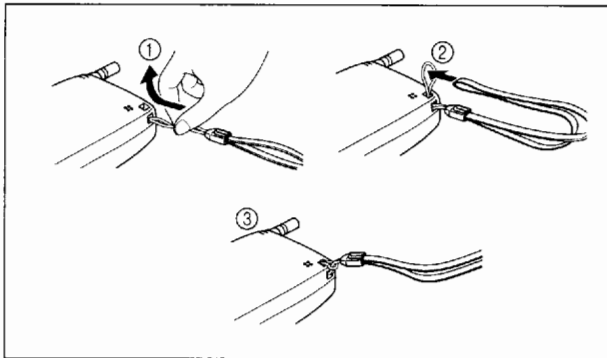

BATTERY OPERATION

Be sure that your battery is fully charged before using your phone for the first time. Your phone will not operate without a charged battery.

BATTERY INSERTION/REMOVAL

Battery Insertion

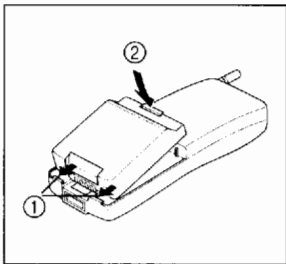

Battery Removal

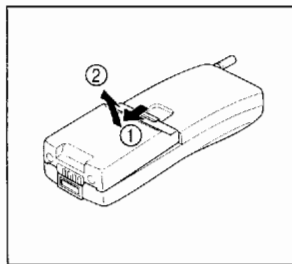

BATTERY CHARGING

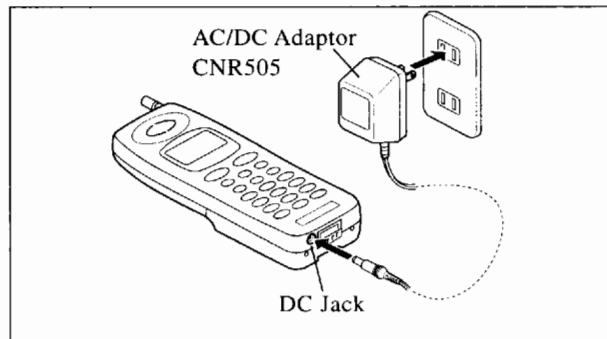

When your battery is charged, "BATT CHARGE" will be displayed. The Power Indicator flashes during charging.

- When "FULL CHARGED" is displayed, battery charging is completed.

Notes:

- **The standard battery BTR405 and the optional BTM405 will be fully charged in about 2 hours. The optional BTE405 will be fully charged in about 3 hours. However, actual charging time varies with battery conditions.**

- **To place or receive calls during charging, press and hold **(PWR)** to turn your phone on. After calls, press and hold **(PWR)** again to turn your phone off.**

CAUTIONS:

- Use only the supplied AC/DC Adaptor CNR505. Using other AC/DC Adaptors can damage the battery and/or the handset.
- Do not discard the battery into fire.
- Do not "short out" the battery (direct connection of the + and - terminals on the battery).
- Do not use any batteries or chargers other than those specifically designed for use with this phone.
- Charge the battery indoors with the ambient temperature between 41°F and 104°F (5°C and 40°C).
- Do not charge the battery in direct sunlight or in high humidity places like a bathroom.

- Do not recharge or “top-off” the battery pack by charging for short periods of time to avoid shortening the battery life. It is recommended to charge the battery after the battery is discharged completely.
- The product that you have purchased contains a rechargeable Battery. The Battery is recyclable. At the end of its useful life, under various state and local laws, it may be illegal to dispose of this Battery into the municipal waste stream. Check with your local solid waste officials for details in your area for recycling options or proper disposal.



Power Management Talk & Stand-By Times

Battery	Talk-Time	Stand-By Time	Weight
800 mAH NICAD BTR405	80 Minutes	12 Hours	7.7 oz.
1200mAH NiMH BTE405	120 Minutes	20 Hours	8.1 oz.
800 mAH NiMH BTM405	80 Minutes	12 Hours	7.7 oz.

Please note all times are approximate.

BATTERY LEVEL INDICATION

To display your battery level, press **(FNC)** **(*)** **(7 PRS)**. To clear the display, press **(CLR)**.

Note that the battery level indication may be affected by variables such as temperature, battery age, and charging conditions.

Talk & Stand-by times can vary and are dependent upon the coverage of the network and how you use your phone.

LOW BATTERY WARNING

When “**L O - b A T T**” flashes every second and an alarm tone sounds, there are only a few minutes left for call processing. If usage continues, “**L O - b A T T**” flashes more frequently. A few moments later, your call is terminated and your phone is automatically turned off.

BASIC OPERATION

TURNING YOUR PHONE ON AND OFF

Press and hold **(PWR)** to turn on your phone. Your own telephone number will be momentarily displayed.

Note: When “NO SVC” (No Service) is displayed, you cannot place or receive calls as the “Cellular System” is not available.

To turn off your phone, press and hold **(PWR)** again.

Backlighting

When you press any key, the backlighting for display and keypad turns on to provide easier operation of your phone. It will go out 8 seconds after the last key press.

Antenna Position

You can receive calls while the antenna is down. However, for optimum performance and signal strength or while operating in poor signal areas, please extend your antenna fully.

Note: The antenna can be used in its fully extended or fully retracted position only.

Display Own Telephone Number

Press **(FNC)**, **(#)**, **(1)**.

To clear the display, press **(CLR)**.

Display Own System ID

Press **(FNC)**, **(#)**, **(3DEF)**.

To clear the display, press **(CLR)**.

PLACING CALLS

- Enter the telephone number.
- Press **(SEND)**.
The **IN USE** indicator will light.
- When you finish talking, press **(END)**.

Example: To call 123-4567

1. Enter **1** **2ABC** **3DEF** **4GHI** **5JKL** **6MNO** **7PRS**.
2. Press **SEND**.
Talk with the other party.
3. To terminate the call, press **END**.

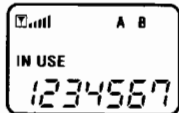

To Correct Entered Digits:

- Press **CLR** to erase the last digit entered.
- Press and hold **CLR** to erase the whole number.

To View Whole Number (Hidden Digits):

Although you can enter up to 32 digits, the display can show the last 11 digits only. To view the whole number, press **FNC** *** 8TUV**. When the whole number is displayed, **F** indicator goes off. If **F** indicator does not go off, press **8TUV** again.

Call-in Progress Protection

Even if **PWR** is pressed during conversation, your call is not interrupted.

RECEIVING CALLS

1. When an incoming call is attempted, an alert tone will sound and "CALL" will flash repeatedly.
2. Press any key except **PWR**, **END**, **▲**, and **▼**.
The **IN USE** will light and you can talk with the other party.
3. To terminate your call, press **END**.

Call in Absence Indication

If calls go unanswered, "CALL" and the number of unanswered calls will be displayed.

To clear the display, press **CLR**.

REDIALING FUNCTIONS

Last Three Numbers Dialed

You can display and redial any of the last three telephone numbers you tried to call.

1. Select one of the telephone numbers out of three.
 - Press **R/S**, **#**, **0OPR** to display the most recent number.

- Press **R/S**, **#**, **1** to display the second most recent number.
 - Press **R/S**, **#**, **2ABC** to display the third most recent number.
2. Press **SEND** for redialing.

Note: If "READY" is displayed and you wish to redial the last number dialed, simply press **SEND.**

Automatic Redial (Programmable Option)

If Automatic Redial is selected, your phone will automatically continue redialing in 20 seconds if the attempt to reach the cell site is not successful. The **IN USE** indicator will stay on, but the earpiece speaker will be muted.

Note: Automatic Redial will initiate only on a "Cellular System" busy signal but not on a "Line" busy signal.

MIC MUTE DURING CONVERSATION

To Mute the Microphone:

During conversation, press **FNC**, **2ABC**.

To Release Mute:

During conversation, press **FNC**, **2ABC** again.

Note: The mute will be automatically released when the call is terminated.

VOLUME ADJUSTMENT

Your phone has 7-level volume controls each for the Earpiece volume, the alert level and the keypad tone level.

Earpiece Volume

During conversation, press **▲** or **▼** to raise or lower the loudness of the other party's voice.

While not in use, press **FNC**, *** 9WXY**, **0OPR** to display "VOL CLR". Press **▲** or **▼** to adjust the earpiece Volume.

Alert Volume

During ringing, press **▲** or **▼** to raise or lower the alert volume level.

While not in use, press **FNC**, *** 9WXY**, **1** to display "ALERT". Press **▲** or **▼** to adjust the Alert Volume.

Keypad Tone Volume

In standby mode, press **▲** or **▼** to raise or lower the keypad tone volume level.

ENHANCED OPERATION

LOCKING/UNLOCKING YOUR PHONE

You can restrict outgoing calls except for the Programmable One Touch Emergency Call, Emergency (911, 000, 119), and the number stored in the emergency/priority dialing area. Your phone will receive calls normally even if it is locked.

Locking your Phone

1. Press **FNC**, **5JKL**.
2. Enter the 3-digit Unlock code.

Notes:

- Please contact your authorized Audiovox dealer to check the initial Unlock code.
- If your phone is locked, “LOC d” will be displayed when your phone is powered up.

To Unlock your Phone:

While “LOC d” is displayed, enter the 3-digit Unlock code.

Changing the Unlock Code

1. Press **FNC**, **#**, **5JKL**, **1**.
“UL P _ _ _” will be displayed.
2. Enter the current 3-digit Unlock code.

Note: Please contact your authorized Audiovox dealer to check the initial Unlock code.

“UL d” will be displayed.

3. Enter a new 3-digit Unlock code except 911, 000, and 119.
4. Press **R/S**.

CAUTION: Keep the record of new code in a safe place!

AUTOMATIC LOCK (Programmable Option)

You can automatically lock your phone by programmable option each time your phone is turned on.

The display shows “LOC d” when your phone is turned on. Even in automatic lock mode, your phone will receive calls normally.

To Unlock your Phone:

Enter the 3-digit Unlock code.

KEYPAD DISABLE FUNCTION IN HANDSFREE MODE (Programmable Option)

This function prevents accidental or unintentional use of the keypad in handsfree mode.

When this function is activated by Programmable option, no key operations in handsfree mode are possible. The display shows “PAD d ISABLE” each time your phone is turned on.

Note: Even in keypad disable mode, your phone will receive calls normally.

To Temporarily Release Keypad Disable Mode:

Press and hold ***** and **#** simultaneously.
“PAD d ISABLE” will disappear.

To Return to Keypad Disable Mode:

Press and hold ***** and **#** simultaneously again.
“PAD d ISABLE” will be displayed.

Notes:

- When handsfree curly cord is disconnected from your phone, key operations become possible and “PAD d ISABLE” disappears.

- When both automatic lock and keypad disable modes are selected by Programmable option and your phone is disconnected from the curly cord, your phone goes into the locked mode automatically.

- When both automatic lock and keypad disable modes are selected by Programmable option and your phone is connected to the handsfree kit with curly cord, the display shows “PAD d ISABLE” upon powering up.

STORING IN THE MEMORY

You can store telephone numbers in the 25 memory locations. For each memory location, you can store a telephone number of up to 32 digits.

Manual Storage

Telephone numbers can be stored manually into the memory locations 01 to 25.

1. Press (CLR), then enter the telephone number.
2. Press (FNC), (R/S). Entered phone number will flash.
3. Enter a 2-digit location number (01-25). The stored telephone number will be displayed.
4. Press (CLR).

Note: If the selected memory location number is already used, the previous information will be overwritten.

Example: To store telephone No. 123-4567 in memory location No. 11

1. Press (CLR), then enter (1) (2ABC) (3DEF) (4GHI) (5JKL) (6MNO) (7PRS).
2. Press (FNC) (R/S).
3. Enter (1) (1) while the telephone number is flashing.
4. Press (CLR) to clear the display.

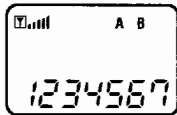

Automatic Storage

You can automatically store telephone numbers in vacant memory locations.

1. Press (CLR), then enter the telephone number.
2. Press (FNC), (R/S), (R/S).
The telephone number is automatically stored in the first available vacant memory location.
The stored location will be displayed momentarily.
3. Press (CLR).

Note: If there is no available location, "FULL" will be displayed momentarily. In this case, choose a memory location that you wish to overwrite with the new information.

Example: To automatically store telephone No. 345-6789 in vacant memory

1. Press (CLR), then enter (3DEF) (4GHI) (5JKL) (6MNO) (7PRS) (8TUV) (9WXY).
2. Press (FNC) (R/S) (R/S).

The telephone number will be automatically stored in the vacant memory location 12, for example.

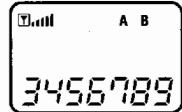

3. Press (CLR).

Storage After Vacant Memory Location Search

You can search for unused memory locations for which telephone numbers can be stored.

1. Press (CLR), then enter the telephone number.
2. Press (FNC), (R/S).
3. Press (▲) or (▼) to search for the desired vacant memory location.
4. Press (R/S) to store in that memory location.
5. Press (CLR).

Example: To store telephone No. 456-7890 in a vacant memory location

1. Press (CLR), then enter (4GHI) (5JKL) (6MNO) (7PRS) (8TUV) (9WXY) (0OPQ).
2. Press (FNC) (R/S).
3. Press (▲) or (▼) to search for vacant memory location.
4. Press (R/S).
5. Press (CLR).

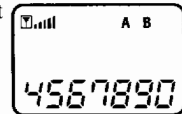

Notes: • To exit the Vacant Memory Location Search function, press (END).

• If there is no available location, "FULL" will be displayed momentarily. In this case, choose a memory location that you wish to overwrite with new information.

EDITING THE TELEPHONE NUMBERS

To Change the Telephone Number of Location No. XX (01-25):

1. Press **(CLR)**, then enter a new telephone number.
2. Press **(FNC)**, **(R/S)**. The entered telephone number will flash.
3. Enter 2-digit location number to store the new number.

To Delete the Telephone Number of Location No. XX (1-25):

1. Press **(FNC)**, **(R/S)**. "READY" will flash.
2. Press Memory Location Number where you wish to delete memorized telephone number.

Note: To check the Memory Location Number where you wish to delete the number, use Memory Search.

MEMORY SEARCH

When you wish to search the memory information:

1. Press **(R/S)**.
2. Press **(▲)** or **(▼)** to scroll up/down memory information.

Note: Holding **(▲) or **(▼)** automatically scrolls up/down memory information.**

RECALLING NUMBERS FROM MEMORY

Memory Dialing

Telephone numbers can be recalled and dialed from one of any 25 different memory locations.

1. Press **(R/S)**.
2. Enter the 1 or 2 digit location number (1-25).
The telephone number will be displayed.
3. Press **(SEND)** to initiate dialing.

Note: If nothing is stored in a particular memory location, "EMPTY" will be displayed momentarily. In this case, check the memory location with Memory Search.

Example: To place a call using memory location No. 11

1. Press **(R/S)**.
2. Enter **(1)** **(1)**.
3. Press **(SEND)**.

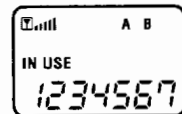

Dialing after Telephone Number Search

You can scan, recall and dial numbers stored in memory locations 1 through 25.

1. Press **(R/S)**.
2. Press **(▲)** or **(▼)** to scroll up or down the memory locations.
3. If your desired telephone number is displayed, press **(SEND)** to initiate dialing.

Note: To exit the search mode, press **(END) at any time.**

Speed Dialing

You can place a call from the stored memory locations 1 to 9 using the keys **(1)** to **(9wv)**.

1. Press one of keys **(1)** to **(9wv)**.
2. Press **(SEND)** to initiate dialing.

PROGRAMMABLE ONE TOUCH EMERGENCY CALL

You can place an emergency call with **(1)** key alone, even when your phone is in lock and/or call restriction mode. 911 is the preset emergency number. You can reprogram this number with another number (up to 7 digits) if you wish. Also, you can deactivate this feature to avoid an unintentional call by mistake.

Placing One Touch Emergency Call

1. Press and hold **(1)** for 2 seconds.

The pre-programmed emergency number will be displayed, and the **IN USE** indicator will light as the call is placed.

One Touch Emergency Call ON/OFF

1. Press **(FNC)**, **(*)**, **(4GH)**.
2. Enter the 3-digit Unlock code.
3. Press **(▲)** to select "ON", or **(▼)** to select "OFF".
4. Press **(R/S)** to store.
5. Press **(CLR)** to clear the display.

Programming a New Emergency Number

1. Press **(FNC)**, **(*)**, **(4GH)**.
2. Enter the 3-digit Unlock code.
3. Enter a new emergency number (Max. 7 digits).
4. Press **(R/S)** to store.
5. Press **(CLR)** to clear the display.

SCRATCH PAD MEMORY

As a sort of numerical note pad, you can enter up to 3 entries in special memory locations (memory locations 26 to 28) of up to 32 digits each. Also, you can place a call from the scratch pad memory. The 4th entry scrolls the scratch pad memory and the number entered first is erased.

Note: Contents of the scratch pad memory will not be cleared even if your phone is turned off.

Storing Numbers in the Scratch Pad Memory

1. Press **(CLR)** and enter a number you wish to store (up to 32 digits).
2. Press **(FNC)**, **(1)**.

Dialing Numbers in the Scratch Pad Memory

1. Press **(R/S)**.
2. Enter one of the location numbers (26 to 28).
Example: Enter **(2ABC)** **(6MNC)** to recall the last number entered.
3. Press **(SEND)** to initiate dialing.

EMERGENCY AND PRIORITY DIALING

You can store a single telephone number up to 32 digits for emergency or priority purpose. The memory location 29 is reserved for this purpose.

Storing the Emergency and Priority Number

1. Press **(CLR)**, then enter the telephone number.
2. Press **(FNC)**, **(R/S)**.
3. Enter **(2ABC)**, **(9WXY)** while the telephone number is flashing.
4. Press **(CLR)** to clear the display.

Dialing the Emergency and Priority Number

1. Press **(R/S)**, **(2ABC)**, **(9WXY)**.
2. Press **(SEND)**.

Note: The emergency and priority number will automatically be redialed up to 3 times at 50 second intervals or until a connection is made.

During redialing sequence, "Pr 10r" will be displayed indicating that this feature is in operation.

EXTENDED FEATURES AND FUNCTIONS

CALL RESTRICTION

In the call restriction mode, only specific keys are effective to prevent unauthorized operation of your phone. Only the following keys are operative to place a call.

1) Any combination of numbers 1 and 2 for a call:

- (R/S) + (1, 2, 11, 12, 21, 22) + (SEND)

2) Emergency Calls:

- (R/S) + 2 + 9 + (SEND)
- 9 + 1 + 1 + (SEND)
- 0 + 0 + 0 + (SEND)
- 1 + 1 + 9 + (SEND)

3) One Touch Emergency Call:

- Holding (1) for 2 seconds.

Note: You can receive a call even if your phone is in the call restriction mode.

To Activate Call Restriction

1. Press (FNC), (*), (5JKL).
2. Enter the 3-digit Call Restriction code.

Note: Please contact your authorized Audiovox dealer to check the initial Call Restriction code.

“LR” will be displayed to indicate that call restriction is in effect.

Note: The call restriction is effective until it is deactivated. When your phone is powered up, “LR” will be displayed. (“LOC” will be displayed if your phone is locked.)

To Exit Call Restriction Mode:

While “LR” is displayed, enter the 3-digit Call Restriction code.

To Change the Call Restriction Code

1. Press (FNC), (#), (5JKL), (2ABC).
“LR P _ _ _” will be displayed.
2. Enter the current 3-digit Call Restriction code.
“LR n” will be displayed.
3. Enter a new 3-digit Call Restriction code except 911, 000, and 119.
4. Press (R/S).

CAUTION: Keep the record of new code in a safe place!

Note: If you enter a wrong code in step 2, your phone returns to standby mode.

KEYPAD (DTMF) TONES

Dual Tone Multi-Frequency (DTMF), or “Keypad Tone” signals can be transmitted during a call by entering digits on the keypad or recalling numbers from the memory. By sending the DTMF signals, you can access special services such as voice mail and answering machines that require long duration tone.

Keypad (DTMF) Tones Duration Selection

To toggle the Long Tone and Short Tone for the time duration of DTMF tones, press (FNC), (#), (8TUV).

Keypad (DTMF) Tones Mute during conversation

To mute the keypad (DTMF) tone, press (FNC), (3DEF) during conversation.

To enable the keypad (DTMF) tones, press (FNC), (3DEF) again during conversation.

Sending DTMF Tones During a Call

From the Keypad:

1. During a call, press any key on the keypad.

From the Memory:

1. During a call, press (R/S), (*).
2. Enter a 2-digit memory location (01-28).

TIMER AND COUNTER FUNCTIONS

Elapsed Time Display

You can display the elapsed time of the call or last call while not in use.

1. Press (FNC), (*), (3DEF), (0OPER).
“LR XX-xx” will be displayed. (XX: Minutes, xx: Seconds)
2. Press (CLR) to exit this mode.

Note: The time count will automatically reset to 00:00 after 99 minutes and 59 seconds.

Outgoing Call Timer

You can display your outgoing call time.

1. Press (FNC), (*), (3DEF), (1).
2. Enter the 2-digit Call Timer code.

Note: Please contact your authorized Audiovox dealer to check the initial Call Timer code.

“0 - R XXXX - xx” will be displayed. (XXXX: Hours, xx: Minutes)

To exit this mode, press (CLR).

To reset the Outgoing Call Timer to 0000:00, press (*), (CLR).

Note: The timer will automatically reset to 0000:00 after 9,999 hours and 59 minutes.

Cumulative Call Timer

You can display a running total of on-air usage.

1. Press (FNC), (*), (3DEF), (2ABC).
2. Enter the 2-digit Call Timer code.

Note: Please contact your authorized Audiovox dealer to check the initial Call Timer code.

“C - R XXXX - xx” will be displayed. (XXXX: Hours, xx: Minutes)

To exit this mode, press (CLR).

To reset the Cumulative Call Timer to 0000:00, press (*), (CLR).

Note: The timer will automatically reset to 0000:00 after 9,999 hours and 59 minutes have been accumulated.

Temporary Accumulated Call Counter

You can display the temporary accumulated number of calls.

1. Press (FNC), (*), (2ABC), (0OPR).

“C R L L XXXX” will be displayed. (XXXX: Number of calls)

To exit this mode, press (CLR).

To reset the total number to 0000, press (*), (CLR).

Note: The call counter will automatically reset to 0 after 9,999 calls.

Outgoing Call Counter

You can check the accumulated number of outgoing calls.

1. Press (FNC), (*), (2ABC), (1).
2. Enter the 2-digit Call Counter code.

Note: Please contact your authorized Audiovox dealer to check the initial Call Counter code.

“0 - C XXXX” will be displayed. (XXXX: Number of outgoing calls)

To exit this mode, press (CLR).

To reset the Outgoing Call Counter to 0000, press (*), (CLR).

Note: The call counter will automatically reset to 0 after 9,999 calls.

Accumulated Call Counter

You can check the accumulated number of calls.

1. Press (FNC), (*), (2ABC), (2ABC).
2. Enter the 2-digit Call Counter code.

Note: Please contact your authorized Audiovox dealer to check the initial Call Counter code.

“C - C XXXX” will be displayed. (XXXX: Number of calls)

To exit this mode, press (CLR).

To reset the Accumulated Call Counter to 0000, press (*), (CLR).

Note: The call counter will automatically reset to 0 after 9,999th call has been made.

To Change the Call Timer/Call Counter Codes

- In case of Call Timer code change, press (FNC), (#), (5JKL), (4GH).

“R R P _ _” will be displayed.

- In case of Call Counter code change, press (FNC), (#), (5JKL), (3DEF).

“C R L P _ _” will be displayed.

2. Enter the current code.

Note: Please contact your authorized Audiovox dealer to check the initial code.

“R R R” or “C R L R” will be displayed.

3. Enter a new 2-digit code.

4. Press (R/S).

CAUTION: Keep the record of new codes in a safe place!

Call Time Warning Tone

You can turn the Call Time Warning Tone on and off. When it is set to on, a single warning tone will be heard every 1 minute and a double warning tone will be heard every 5 minutes during a call.

To Turn the Warning Tone ON:

1. Press **(FNC)**, **(*)**, **(1)** while not in use.
“**bEEP on**” will be displayed.
2. Press **(CLR)** to clear the display.

To Turn the Warning Tone OFF:

1. Press **(FNC)**, **(*)**, **(1)** again while not in use. On/off toggles and “**bEEP OFF**” will be displayed.
2. Press **(CLR)** to clear the display.

SID MANAGEMENT (Programmable Option)

You can take advantage of a family of SID (System Identification) groups by this Programmable option. This is a group of cellular systems in cities that your carrier owns or has special billing arrangements with. Your close family SID's will be billed at the same rate as your home billing. (Both **NO SVC** and **ROAM** are off.) More distant family SID's will be billed at a preferred rate. Your phone will display solid **ROAM**. When flashing **ROAM** is displayed, you are using a SID system that is not included in the groups assigned at the time of programming.

If your display indicates **NO SVC**, you will need to change your A/B system selection or, please refer to Multiple City Registration to change phone registration to enable you to make a call.

A/B SYSTEM SELECTION

You can select the system you need to use. The system that you are registered with is the preferred system and your home system.

To select Standard Mode, press **(FNC)** **(6MNO)** **(0PES)**.

To select System A Only Mode, press **(FNC)** **(6MNO)** **(1)**.

To select System B Only Mode, press **(FNC)** **(6MNO)** **(2ABC)**.

To select Home Mode, press **(FNC)** **(6MNO)** **(3DEF)**.

To select Family First Mode, press **(FNC)** **(6MNO)** **(4GHI)**.

To check the current system selection, press **(FNC)** **(6MNO)** **(5JKL)**.

To clear the display, press **(CLR)**.

Note: When you turn your phone on, your phone will start to scan the system of the last power-off.

Standard Mode:

Your phone will scan the preferred system channels. If unable to find an acceptable preferred channel, your phone switches to scan the non-preferred system channels. “**A B**” will light in the display.

System A Only Mode:

Your phone will scan the system A only. “**A**” will light in the display.

System B Only Mode:

Your phone will scan the system B only. “**B**” will light in the display.

Home Mode:

Your phone will scan preferred system and Brother/Sister system channels.

You can place or receive calls only within your Home area.

Family Mode:

Your phone will scan both systems A and B regardless of Brother/Sister or Cousin system channels.

MULTIPLE CITY REGISTRATION

You can reprogram the different phone numbers for the cities in which you are registered. Each programmed phone number will be designated as your home system.

Note: You must register your phone with the carrier to get the system ID number and your phone number.

To Program the Phone Number:

1. Press **(CLR)**, then enter the new system ID number (5 digits).
2. Enter corresponding phone number including your area code (10 digits).
3. Press **(FNC)**, **(#)**, **(#)**.
4. Enter the 3-digit Unlock code.

After programming the new number, your phone automatically wakes up again and displays the new phone number.

Note: Calls are placed or received using the programmed phone number only.

CURRENT SID, CHANNEL AND RSSI LEVEL DISPLAY

To see your Current SID (System Identification), press **(FNC)** **(*)** **(D)** **(OFF)**. To clear the display, press **(CLR)**.

To see your Current Channel and RSSI (Received Signal Strength Indication) level, press **(FNC)** **(*)** **(6)** **(MC)**. To clear the display, press **(CLR)**.

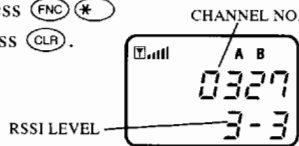

ESN (Electronic Serial Number) Display

Press **(FNC)**, **(#)**, **(2)** **(ABC)** to display your ESN.

To clear the display, press **(CLR)**.

ANTI FRAUD SECURITY FEATURE (PIN Feature)

If your cellular carrier offers Personal Identification Number (PIN) service, your new phone must be programmed with your PIN. For your protection, you cannot make any outgoing calls until establishing your PIN. Please contact your cellular service provider for specific instructions.

To Place a Call Using the PIN service:

1. Enter the telephone number.
2. Press **(SEND)**.
“P on” will flash in the display.
3. Press **(SEND)** again. Your call will then be placed.

To Enter the PIN and Turn the PIN Feature ON or OFF:

1. Press **(FNC)**, **(#)**, **(*)**.
2. Enter the 3-digit Unlock code.

Note: Please contact your authorized Audiovox dealer to check the initial Unlock code.

3. Enter your PIN (up to 6 digits).
4. Press **(▲)** or **(▼)** to turn the PIN feature on or off.
5. Press **(R/S)**.
6. To exit the mode, press **(CLR)**.

ENHANCED FEATURE OPERATION

The feature operation on the following pages pertains to “Enhanced Features” that may be offered by your cellular service provider. Before you can use these features, you must subscribe to them through your home cellular service provider.

Note: These optional network services may not be available in all areas.

Message Display On/Off Mode Selection

Message Display OFF mode is preset at the factory.

1. To toggle Message Display ON/OFF mode, press **(FNC)** **(7)** **(PNS)** **(1)**.
2. Then enter 3 digit Lock code. “MS on ModE” or “MS of ModE” will be displayed.
3. To clear the display, press **(CLR)**.

Message Display at Message receiving

When Message Display Mode is Off and a message is received, the number of unread messages and “MSG” or “u-MR L” will be displayed. To view the message, enter Message Review Mode by pressing **(R/S)** **(R/S)** (Hold the second **(R/S)** for 2 seconds).

When Message Display Mode is On and a message is received, “MSG” or “u-MR L” will flash in the display. To view the message, press any key except **(PWR)** and **(END)**.

Message Display Upon Power Up

When Message Display Mode is Off and there are unread messages in the memory, there will not be anything indicated in the display.

When Message Display Mode is On and there are unread messages in the memory, the display will indicate the number of stored messages and the number of unread messages. For example, if the display indicates “MS 10-03,” “10” indicates the number of stored messages and “03” indicates the number of unread messages.

Common Incoming Memory Stack

Your phone has a memory stack of 20 messages for the Message Services. Each message consists of up to 32 digits or 32 characters.

When your phone receives more than 20 messages, the message marked with “-” will be deleted from memory first.

When your phone has no memory marked with “-”, the oldest message will be deleted so that the latest 20 messages remain in the memory stack.

Note: When a particular message is marked with “-”, the message will not be deleted by this operation.

Message Review

1. Press (R/S) (R/S) to enter Message Review Mode.
(Hold the second (R/S) for 2 seconds)
2. “MS 10-03” will be displayed, for example.
In this case, “10” indicates the number of stored messages and “03” indicates the number of unreviewed messages.

Note: When your phone has no messages, “no MSGS” will be displayed. To clear the display, press (CLR).

3. For specific key operations for message service, please use the following key operations:
 - a. To search and display unreviewed messages, press (R/S).
 - b. To show the message from the latest memory, press (V).
 - c. To show the message from the oldest memory, press (A).
 - d. To hold the message in memory, press (*).
“-” will be displayed. Maximum 10 messages can be held in the memory.
 - e. To prioritize deletion of a specific message, press the (#) key while message is displayed. When your phone attempts to store over 20 messages, the message with the “-” mark will be deleted first.
 - f. To delete the displayed message from memory, press (CLR) (CLR).
 - g. To delete all the messages from memory, press (CLR) (CLR) (Hold the first (CLR) for 2 seconds).
 - h. To store the displayed message except Short Messages and Voice Mail into a phone number memory, press (FNC) (R/S) and enter one of memory locations of 01 to 25.
 - i. To originate a call to the displayed number except Short Message, press (SEND).
 - j. To exit Message Review Mode, press (END).

Notes: • After a message has been reviewed, “-” will be displayed.

• When all the messages have been reviewed by (R/S) operation, “ALL REVIEWED” will be displayed momentarily.

Example (After entering Message Review Mode)

- 1) Press (R/S) to display unreviewed message only.

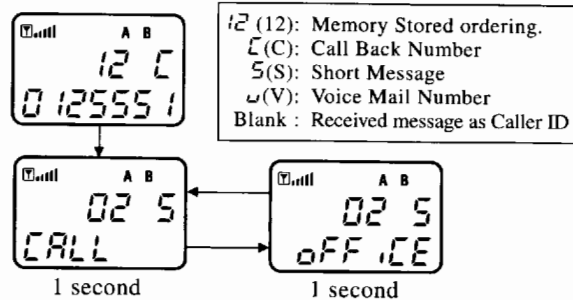

- 2) Press (V)/(A) to display messages in order.

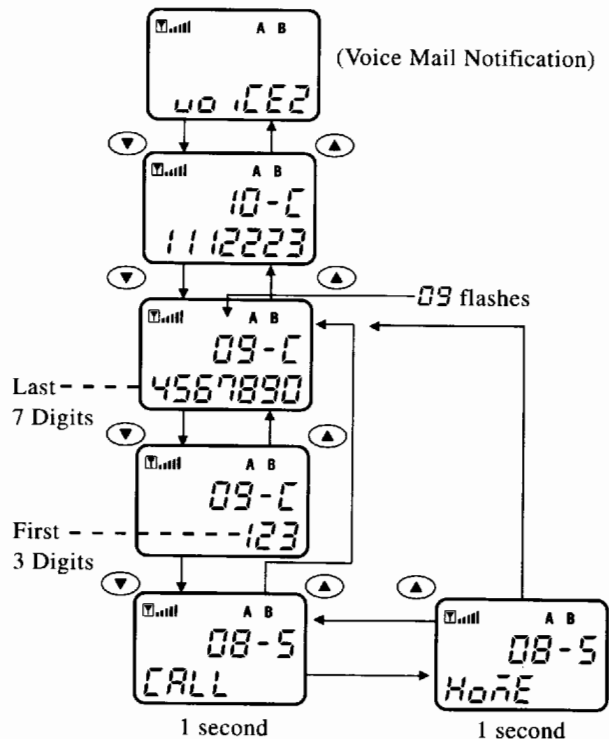

Deleting a Message Individually

1. Press **(CLR)** momentarily. "CLR" will flash in the display.
2. If you do not wish to delete the message, press **(END)**. Or to execute the deletion of the message, press **(CLR)**. "CLEARED" will be displayed momentarily.

Deleting all the Messages

1. Press and hold **(CLR)** for 2 seconds. "ALL CLR" will flash in the display.
2. If you do not wish to delete all the messages, press **(END)**. Or to execute the deletion of all the messages, press **(CLR)**. "ALL CLEARED" will be displayed momentarily.

Storing a Digit Message of Call Back Number and Caller ID into Phone Number Memory

1. Press **(FNC)** **(R/S)**.
2. Then enter XY. (XY is a memory number of 01 to 25.) Or to automatically store a digit message at an unused memory location, press **(FNC)** **(R/S)** **(R/S)**. The stored memory number will be displayed for one second.

Notes: • Only digit messages can be stored.

- UNA (Number not available) and RES (Number Restricted) or Short Message will not be stored.

Caller ID

When your phone receives a call, the caller's phone number will flash in the display. If you are in a conversation and another call is attempted, the caller's phone number will be displayed in Call Waiting. The caller's phone number will be stored in the memory.

To answer the call, press any key except **(PWR)** and **(END)**.

If you do not answer the call, the number of unanswered call will be displayed and the caller's phone number will be stored in the memory.

Voice Mail Access Number

In the following cases, you can place a call to your Voice Mail Access number in Memory number 30 by pressing **(SEND)** only.

- At Voice Mail Notification
- At Short Message "SMS" display during Message Review mode

Note: It is required to store your Voice Mail Access number in Memory number 30 in advance by usual memory storing operation.

Message Beep Alert

Your phone will beep when receiving Message services:

- Short Message..... Repeat of single Beep
- Voice Mail Number/
Voice Mail Notification..... Repeat of two Beeps
- Call Back Number.....Repeat of three Beeps
- Flash with InfoRepeat of three Beeps

Note: When Message Display Mode is Off, the above Beep Alert will not be repeated.

Message Beep Alert Tone Level Control

You can adjust Beep Alert tone level to seven levels while not in use.

1. Press **(FNC)** **(*)** **(9)** **(3)** **(DEF)**.

The current Beep Alert Tone will be heard and the level will be displayed.

2. Press **(▲)** or **(▼)** according to your desired tone level.
3. To clear the display, press **(CLR)**.

Message Beep On/Off Selection

Message Beep ON mode is preset at the factory.

1. To toggle Message Beep On/Off mode, press **(FNC)** **(7)** **(FMS)** **(2)** **(ABC)**. "MS BEEP OF" or "MS BEEP ON" will be displayed.
2. To clear the display, press **(CLR)**.

When Message Beep Alert Mode is Off, Message Beep Alert will not sound even if your phone receives Message services.

When Message Beep Alert Mode is Off, "MS BEEP OF" will be displayed upon power up. To clear the display, press **(CLR)**.

AUDIOVOX ACCESSORY CATALOG MVX-501/505/506/507



BTR-405
Standard Life NiCad Battery
(800 mAh) (standard with
MVX-501/505/506)



BTE-405
Extended Life NiMH
Battery (1200 mAh)
(standard with MVX-507)

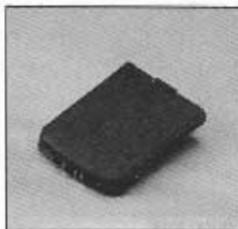

BTM-405
Slim NiMH Battery
(800 mAh) (option)



DTC-405
Desk Top Charger
(option)



HF-505
Hands Free Mobile Kit
(option)



CLA-505
Cigarette Lighter Adapter
(option)



RC-505
Rapid Charger
(standard with MVX-507)



CHF-505
Cigarette Lighter Hands
Free (option)



CLP-505
Cigarette Lighter
Charger (option)



LB-405
Leather Carrying Case
(option)



PBK-405
3 Watt RF Power
Booster (must be used
with HF-505) (option)

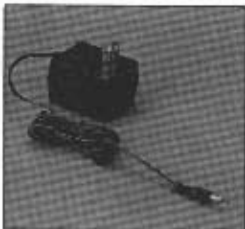

CNR-505
AC Rapid Charger (stan-
dard with MVX-501/505/
506)



PCP501
Personalized Colored Plastics

Available Colors:

- Dark Blue PCP501DB
- Forest Green PCP501FG
- Yellow PCP501Y
- Ruby Red PCP501RR
- Wood Grain PCP501WG

WS-700
Wrist Strap (Not shown)

These accessories are available at your local AUDIOVOX Dealer. For more information call 1-800-1CELE.



PROTECT YOUR WARRANTY

Read your Warranty carefully, with the special consideration to paragraph seven of the Limited Warranty for your unit.

"Warranty does not apply to...or to any product or part thereof which has suffered through alteration... mishandling, misuse, neglect, or accident".

Many companies are making look-alike accessories and in some cases, promoting that their product is equal to or better than the Audiovox product. Be careful. Some of these products may not be compatible for use with your Audiovox product and may damage the unit or cause it to malfunction. If service is required on your unit, and it is determined that a non-Audiovox accessory has created the problem with your unit, the Warranty will not apply. In addition, if the unit has already suffered irreversible damage by reason of a non-compatible accessory, the Warranty will be voided. To protect your Warranty, use only compatible accessories which cannot damage or interfere with the functioning of your Audiovox product.



AUDIOVOX COMMUNICATIONS CORP.

185 Oser Avenue, Hauppauge, New York 11788, 516-233-3300
16808 Marquardt Avenue, Cerritos, California 90701, 562-802-5100
Audiovox Canada
405 Britannia Rd. East, Ste 101, Mississauga, Ontario, Canada
L4Z3E6, 905-712-9299
Audiovox Pacific Pty Ltd
110 Rocky Point Road, Kogarah, NSW 2217, Australia, 02-9587-0011
Audiovox New Zealand Pty Ltd
Unit B, 6 Henderson Place, Auckland, 6496345720
Audiovox Singapore Pte Ltd
268 Orchard Road, #07-07, Singapore, 238856, 65-733-5902
<http://www.audiovox.com>

©1997 Audiovox Corporation

GENERAL SPECIFICATIONS

Frequency Range:

Transmit: 824.040 to 848.970 MHz

Receive: 869.040 to 893.970 MHz

Number of RF Channels: 832 Channels, Full Duplex

Channel Spacing: 30 KHz

Duplex Spacing: 45 MHz

Frequency Stability: ±2.5 PPM

Operating Temperature:

Main Unit: -22°F to +140°F (-30°C to +60°C)

Battery: +5°F to +122°F (-15°C to +50°C)

Battery Charging

Temperature: +41°F to +104°F (5°C to +40°C)

Supply Voltage: 4.8 V – DC

RF Power Output: 0.6 W

Dimensions: 6.3" × 2.3" × 0.9"
(159 mm × 60 mm × 24 mm)

Weight:

with Standard Ni-Cad Battery: Approx. 7.7 oz. (218 g)

with Slim profile Ni-MH Battery: Approx. 7.7 oz. (218 g)

with Extended life Ni-MH Battery: Approx. 8.1 oz. (231 g)

Talk Time:

with Standard Ni-Cad Battery: Approx. 80 Minutes

with Slim profile Ni-MH Battery: Approx. 80 Minutes

with Extended life Ni-MH Battery: Approx. 120 Minutes

Stand-by Time:

with Standard Ni-Cad Battery: Approx. 12 Hours

with Slim profile Ni-MH Battery: Approx. 12 Hours

with Extended life Ni-MH Battery: Approx. 20 Hours

* Subject to change without notice.

TABLE OF KEY OPERATION

Key operation	Function
(PWR)	Holding (PWR) turns your phone on and off.
Phone No. + (FNC) + (1)	Stores to Scratch Pad Memory.
(FNC) + (2ABC) (During conversation)	Switches the Mute mode on and off.
(FNC) + (3DEF) (During conversation)	Turns the DTMF tone on and off.
(FNC) + (5JKL) + 3 Digit Code	Locks your phone electronically.
(FNC) + (6MNO) + (0OPR)	Switches to the Standard scan mode.
(FNC) + (6MNO) + (1)	Switches to the System A Only mode.
(FNC) + (6MNO) + (2ABC)	Switches to the System B Only mode.
(FNC) + (6MNO) + (3DEF)	Switches to the Home mode.
(FNC) + (6MNO) + (4GHI)	Switches to the Family First mode.
(FNC) + (6MNO) + (5JKL)	Displays current scan mode.
(FNC) + (*) + (0OPR)	Displays your current SID.
(FNC) + (*) + (1)	Turns the Call Time Warning Tone on and off.
(FNC) + (*) + (2ABC) + (0OPR)	Displays the temporarily accumulated number of calls.
(FNC) + (*) + (2ABC) + (1) +2 Digit Code	Displays the number of outgoing calls.
(FNC) + (*) + (2ABC) + (2ABC) +2 Digit Code	Displays the accumulated number of calls.
(FNC) + (*) + (3DEF) + (0OPR)	Displays the time of current or last call.
(FNC) + (*) + (3DEF) + (1) +2 Digit Code	Displays the time of outgoing calls.
(FNC) + (*) + (3DEF) + (2ABC) +2 Digit Code	Displays the cumulative call time.

Key operation	Function
$\text{FNC} + * + 4\text{GH} + 3\text{ Digit Code} + \text{New Emergency No.} + \blacktriangle / \blacktriangledown + \text{R/S}$	Changes Emergency Number and turns the One Touch Emergency call mode on and off.
$\text{FNC} + * + 5\text{JKL} + 3\text{ Digit Code}$	Activates the Call Restriction mode.
$\text{FNC} + * + 6\text{MNO}$	Displays the current Channel and the RSSI Level.
$\text{FNC} + * + 7\text{PRS}$	Displays the Battery Level.
$\text{FNC} + * + 8\text{TUV}$	Displays the preceding digits.
$\text{FNC} + * + 9\text{WXY} + 0\text{OPR} + \blacktriangle / \blacktriangledown$	Adjusts the earpiece volume level.
$\text{FNC} + * + 9\text{WXY} + 1 + \blacktriangle / \blacktriangledown$	Adjusts the alert sound output volume level.
$\text{FNC} + * + 9\text{WXY} + 2\text{ABC} + \blacktriangle / \blacktriangledown$	Adjusts the tone volume level.
$\text{FNC} + \# + 1$	Displays own telephone number.
$\text{FNC} + \# + 2\text{ABC}$	Displays the Electronic Serial Number (ESN).
$\text{FNC} + \# + 3\text{DEF}$	Displays the Home System ID (SIDH).
$\text{FNC} + \# + 5\text{JKL} + 1$	Changes the Unlock Code.
$\text{FNC} + \# + 5\text{JKL} + 2\text{ABC}$	Changes the Call Restriction Access Code.
$\text{FNC} + \# + 5\text{JKL} + 3\text{DEF}$	Changes the Call Counter Access Code.
$\text{FNC} + \# + 5\text{JKL} + 4\text{GH}$	Changes the Air Timer Access Code.
$\text{FNC} + \# + 8\text{TUV}$	Changes the Keypad (DTMF) Tone Duration
$\text{FNC} + \# + * + 3\text{ Digit Code} + \text{PIN} + \blacktriangle / \blacktriangledown + \text{R/S}$	Enters PIN and turns PIN feature on and off
$\text{CLR} + 5\text{ Digit New SID} + 10\text{ Digit Phone No.} + \text{FNC} + \# + \# + 3\text{ Digit Code}$	Multiple City Registration (Changes the phone number and SIDH)

Key operation	Function
CLR	Clears the last digit. If held in, erases the entire number from display.
$\text{CLR} + \text{END}$	Clears the entire number from display.
$\text{Phone No.} + \text{FNC} + \text{R/S} + \text{Memory Location No.}$	Stores the telephone number in the memory.
$\text{Phone No.} + \text{FNC} + \text{R/S} + \text{R/S}$	Searches the vacant memory and stores the telephone number automatically.
$\text{Phone No.} + \text{FNC} + \text{R/S} + \blacktriangle / \blacktriangledown$	Searches the vacant memory address to store.
$\text{R/S} + \# + 0\text{OPR} / 1 / 2\text{ABC}$	Displays the telephone number of three latest calls.
$\text{R/S} + \text{Memory Location No.}$	Recalls the telephone number from the memory.
$\text{R/S} + * + \text{Memory Location No.}$	Adds the DTMF tone to the recalled number.
$\text{R/S} + \blacktriangle / \blacktriangledown$	Recalls the telephone number in address order.
SEND	Receives the call when "CALL" is flashed in the display. Redials the last number dialed when "READY" is displayed.
$\text{Phone No.} + \text{SEND}$	Processes the call.
END	Terminates the call.

12 MONTH LIMITED WARRANTY

AUDIOVOX COMMUNICATIONS CORPORATION (the Company), warrants to the original retail purchaser of this Audiovox Cellular Telephone, that should this product or any part there of (except the items listed below), under normal use and conditions, be proven defective in material or workmanship within the first twelve (12) month period from the date of purchase, such defect(s) will be repaired or replaced (with new or rebuilt parts) at the Company's option, without charge for parts or labor directly related to the defect(s).

Accessories, if supplied, except rechargeable battery packs, are similarly warranted for 12 months. Battery packs are warranted from the date of purchase for 90 days. To obtain repairs or replacement within the terms of this Warranty, the product should be delivered with proof of warranty coverage, specification of defect(s), transportation prepaid, to the Company at the address shown below.

In the United States call toll free to (800) 229-1235 [in NY State and other areas, call (516) 233-3410]

This Warranty does not apply to fuses, or costs incurred for removal, reinstallation, testing, evaluation, or to any product or part there of which has suffered through alteration, serial number defacement, improper installation, excessive temperature or humidity, environmental conditions, mishandling, misuse, neglect or accident. This Warranty is not assignable or transferable. THE EXTENT OF THE COMPANY'S LIABILITY UNDER THIS WARRANTY IS LIMITED TO THE REPAIR OR REPLACEMENT PROVIDED ABOVE AND, IN NO EVENT, SHALL THE COMPANY'S LIABILITY EXCEED THE PURCHASE PRICE PAID BY PURCHASER FOR THE PRODUCT.

The Company disclaims liability

for geographic coverage, inadequate signal to antenna, communications range or operation of the Cellular System as a whole. ANY IMPLIED WARRANTIES, INCLUDING ANY IMPLIED WARRANTY OF MERCHANTABILITY SHALL BE LIMITED TO THE DURATION OF THIS WRITTEN WARRANTY, ANY ACTION FOR BREACH OF ANY WARRANTY HEREUNDER INCLUDING ANY IMPLIED WARRANTY OF MERCHANTABILITY MUST BE BROUGHT WITHIN A PERIOD OF 24 MONTHS FROM DATE OF ORIGINAL PURCHASE. IN NO CASE SHALL THE COMPANY BE LIABLE FOR ANY CONSEQUENTIAL OR INCIDENTAL DAMAGES FOR BREACH OF THIS OR ANY OTHER WARRANTY, EXPRESS OR IMPLIED, WHATSOEVER.

No person or representative is authorized to assume for the Company any liability other than expressed herein in connection with the sale of this product.

Some states do not allow limitations on how long an implied warranty lasts or the exclusion or limitation of incidental or consequential damage so the above limitation or exclusions may not apply to you. This Warranty gives you specific legal rights, and you may also have other rights which vary from state to state.

IN U.S.A.: AUDIOVOX COMMUNICATIONS CORPORATION

185 Oser Avenue, Hauppauge, New York 11788 (516) 233-3300

IN CANADA: AUDIOVOX CANADA, LTD.

405 Britannia Road East Suite 101 Mississauga, Ontario L4Z 3E6 (905) 712-9299 (800) 465-9672

INDEX

Accessory Catalog	36
Automatic Lock	17
Automatic Redial	15
Automatic Storage	18
Battery Operation	10
Call Counter Display	
Accumulated Call Counter	27
Outgoing Call Counter	27
Temporary Accumulated Call Counter	26
Call Restriction	24
Call Time Warning Tone	28
Call Timer Display	
Cumulative Call Timer	26
Elapsed Timer Display	25
Outgoing Call Timer	26
Caller ID	34
Emergency and Priority Dialing	23
ESN Display	30
Key/Display Names and Functions	8
Keypad Disable	17
Keypad Tones	25
Locking	16
Manual Storage	18
Memory Dialing	20
Memory Search	20
Message Review	32
Mic Mute	15
Multiple City Registration	29
One Touch Emergency Call	22
PIN Feature	30
Placing Calls	13
Receiving Calls	14
Redialing (Last three numbers dialed)	14
Scratch Pad Memory	23
Speed Dialing	21
System ID (Current System ID) Display	30
System ID (Own System ID) Display	13
System Selection	28
Table of Key Operation	41
Telephone Number (Own) Display	13
Unlocking	16
Volume Adjustment	15

Free Manuals Download Website

<http://myh66.com>

<http://usermanuals.us>

<http://www.somanuals.com>

<http://www.4manuals.cc>

<http://www.manual-lib.com>

<http://www.404manual.com>

<http://www.luxmanual.com>

<http://aubethermostatmanual.com>

Golf course search by state

<http://golfingnear.com>

Email search by domain

<http://emailbydomain.com>

Auto manuals search

<http://auto.somanuals.com>

TV manuals search

<http://tv.somanuals.com>