

MMDVT DVD PLAYER

Owner's Manual



RECORD YOUR MODEL NUMBER (Now, while you can see it)

The model and serial number of your new DVD player are located on the back of the DVD player cabinet.

For your future convenience, we suggest that you record these numbers here:

MODEL NO. _____

SERIAL NO. _____



For Customer Service
Visit Our Website At
www.audiovox.com
Product Information, Photos,
FAQ's, Owner's Manuals

© 2004 AEC 150 Marcus Blvd., Hauppauge, N.Y. 11788

1286972

MADE IN KOREA

Download from www.Somanuals.com. All Manuals Search And Download.

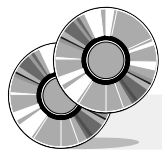

Important Information

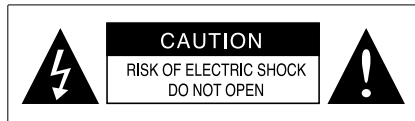

TO REDUCE THE RISK OF ELECTRIC SHOCK, DO NOT REMOVE THE COVER(OR BACK).THERE ARE NO USER-SERVICEABLE PARTS ARE INSIDE. REFER SERVICING TO QUALIFIED SERVICE PERSONNEL.



This symbol indicates "dangerous voltage" inside the product that presents a risk of electric shock or personal injury.



This symbol indicates important instructions accompanying the product.

CAUTION: DVD PLAYERS USE AN INVISIBLE LASER BEAM WHICH CAN CAUSE HAZARDOUS RADIATION EXPOSURE.

CAUTIONS

This product satisfies FCC regulations when shielded cables and connectors are used to connect the unit to other equipment. To prevent electromagnetic interference with electric appliances, such as radios and televisions, use shielded cables and connectors for connections.

FCC NOTE (for U.S.A):

This equipment has been tested and found to comply with the limits for a Class B digital device, pursuant to Part 15 of the FCC rules. These limits are designed to provide reasonable protection against harmful interference in a residential installation. This equipment generates, uses and can radiate radio frequency energy and, if not installed and used in accordance with the instructions, may cause harmful interference to radio or television reception, which can be determined by turning the equipment off and on, the user is encouraged to try to correct the interference by one or more of the following measures.

- Reorient or relocate the receiving antenna.
- Increase the separation between the equipment and receiver.
- Connect this equipment into an outlet on a circuit different from that to which the receiver is connected.
- Consult the dealer or an experienced radio/TV technician for help.

This class B digital apparatus meets all requirements of the Canadian Interference -- Causing Equipment Regulations.

CLASS 1 LASER PRODUCT
LUOKAN 1 LASER LAITE
KLASS 1 LASER APPARAT

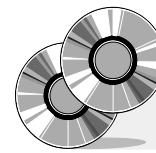

Important Safety Instructions

CAUTION: PLEASE READ AND OBSERVE ALL WARNINGS AND INSTRUCTIONS IN THIS OWNER'S MANUAL AND THOSE MARKED ON THE UNIT. RETAIN THIS BOOKLET FOR FUTURE REFERENCE.

This set has been designed and manufactured to assure personal safety. Improper use can result in electric shock or fire hazard. The safeguards incorporated in this unit will protect you if you observe the following procedures for installation, use and servicing.

This unit is fully transistorized and does not contain any parts that can be repaired by the user.

DO NOT REMOVE THE COVER, OR YOU MAY BE EXPOSED TO DANGEROUS VOLTAGE. REFER SERVICING TO QUALIFIED SERVICE PERSONNEL ONLY.

1. Read owner's manual

After unpacking this product, read the owner's manual carefully, and follow all of the operating instructions.

2. Power Sources

This product should be operated only from the type of power source indicated on the marking label. If you are not sure of the type of power supply in your home, consult your product dealer or local power company. For products intended to operate from battery power, or other sources, refer to the operating instructions. Connect the unit to a switched (ACC) line in your vehicle. There should be 12vdc with the key in the ACC or Run position.

3. Ventilation

Slots and openings in the cabinet are provided for ventilation and to ensure reliable operation of the product and to protect it from overheating. These openings must not be blocked or covered. The openings should never be blocked by placing the product on a bed, sofa, rug or other similar surface. This product should not be placed in a built-in installation such as a bookcase or rack unless proper ventilation is provided or the manufacturer's instructions have been adhered to. In summer, ventilate for 10 minutes before playing Disc. In winter, play Disc after igniting the car.

4. Heat

The product should be situated away from heat sources such as radiators, heat registers, stoves, or other products (including amplifiers) that produce heat.

5. Water and Moisture

Do not use this product near water-for example, near a bath tub, wash bowl, kitchen sink. or laundry tub; in a wet basement; or near a swimming pool and the like.

6. Cleaning

Unplug this product from the wall outlet before cleaning. Do not use liquid cleaners or aerosol cleaners. Use a damp cloth for cleaning.

7. Power-Cord Protection

Power-supply cords should be routed so that they are not likely to be walked on or pinched by items placed upon or against them.

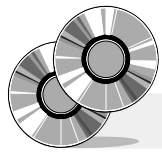

Important Safety Instructions

8. Object and Liquid Entry

Never push objects of any kind into this product through openings as they may touch dangerous voltage points or short-out parts that could result in a fire or electric shock. Never spill liquid of any kind on the product.

9. Attachments

Do not use attachments not recommended by the product manufacturer as they may cause hazards.

10. Accessories, Carts, and Stands

Do not place this product on an unstable cart, stand, tripod, bracket, or table. The product may fall, causing serious injury to a child or adult, and serious damage to the product. Use only with a cart, stand, tripod, bracket, or table recommended by the manufacturer, or sold with the product.

Any mounting of the product should follow the manufacturer's instructions, and should use a mounting accessory recommended by the manufacturer. A product and cart combination should be moved with care. Quick stops, excessive force, and uneven surfaces may cause the product and cart combination to overturn.



A product and

11. Burden

Do not place a heavy object on or step on the product. The object may fall, causing serious personal injury and serious damage to the product.

12. Connecting

When you connect the product to other equipment, turn off the power and unplug all of the equipment. Failure to do so may cause an electric shock and serious personal injury. Read the owner's manual of the other equipment carefully and follow the instructions when making any connections.

13. Sound Volume

Reduce the volume to the minimum level before you turn on the product. Otherwise, sudden high volume sound may cause hearing or speaker damage.

14. Sound Distortion

Do not allow the product to output distorted sound for a long time. It may cause speaker overheating and fire.

15. Laser Beam

Do not look into the opening of the disc tray or ventilation opening of the product to see the source of the laser beam. It may cause sight damage.

16. Disc

Do not use a cracked, deformed, or repaired disc. These discs are easily broken and may cause serious personal injury and product malfunction.

17. Damage Requiring Service

Disconnect all cables and refer servicing to qualified service personnel under the following conditions:

- When the power-supply cord or plug is damaged.
- If liquid has been spilled, or objects have fallen into the product.
- If the product has been exposed to rain or water.
- If the product does not operate normally by following the operating instructions. Adjust only those controls that are covered by the operating instructions as an improper adjustment of other controls may result in damage and will often require extensive work by a qualified technician to restore the product to its normal operation.
- If the product has been dropped or damaged in any way.
- When the product exhibits a distinct change in performance-this indicates a need for service.

18. Servicing

Do not attempt to service this product yourself as opening or removing covers may expose you to dangerous voltage or other hazards. Refer all servicing to qualified service personnel.

19. Replacement parts

When replacement parts are required, be sure the service technician has used replacement parts specified by the manufacturer or have the same characteristics as the original part. Unauthorized substitutions may result in fire, electric shock, or other hazards.

20. Safety Check

Upon completion of any service or repairs to this product, ask the service technician to perform safety checks to determine that the product is in proper operating condition.

21. Installation

Do not stand the player in the left and right direction on above of the angle +10 ~ -10 when playing in a car or at home.
(It may not operate.)

Important Safety Instructions

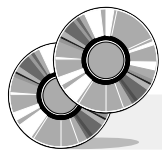

Information about Disc



DVD(Digital Versatile Disc) can record 135 minutes of video, 8 language tracks and maximum 32 languages sub-titles. You can enjoy cinema-like picture and crystal clear sound with MPEG-2 compression technology and dolby digital surround.



Both the DVD player and the discs are coded by region. These regional codes must be matched in order for the disc to be played. If the codes are not matched, the disc will not be played.

Discs you can play



Discs that cannot be played

- DVD PLAYER can not play LD, CD-G, CD-I, CD-ROM, DVD-ROM.
(When appears on screen, it indicates an invalid button press.)

Copy Protection

- Most DVD discs are encoded with macro vision to prevent disc copying.
- This product incorporates copyright protection technology that is protected by the methods of claims of certain U.S. patents and other intellectual property rights owned by Macrovision Corporation, and is intended for home and other limited viewing uses only unless authorized by Macrovision Corporation. Reverse engineering or disassembly is prohibited.
- This product is manufactured by technical co-operation with Dolby Laboratories this symbol and trademark are reserved for Dolby Laboratories.
© Dolby Laboratories Inc. All rights Reserved.

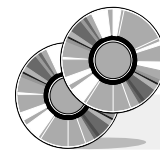

How to care and store disc

- Be careful in handling the disc, because a slight flaw in the disc might affect playback.

How to handle disc

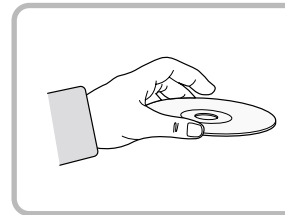

- You can pick up disc without difficulty if you press the center of supporting part when extracting disc from the case.
- Please refer to the left illustration, and do not touch the surface of the disc.
- Do not paste paper or adhesive tape on the disc.
- Be careful not to leave a fingerprint or stain on the disc.

Caution

- Be careful not to leave dirt or other substances on the disc.
- Do not play a cracked disc.

Disc Storage

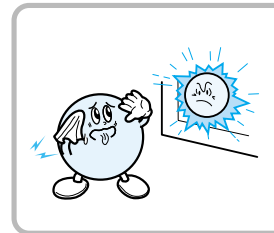

Do not keep under direct sunlight.

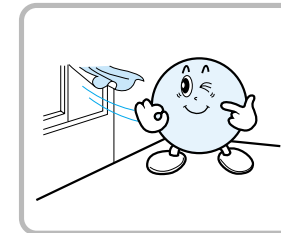

Keep in a cool ventilated area.

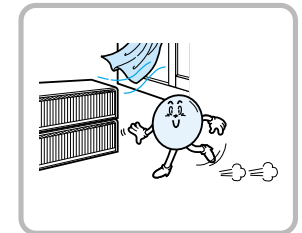

Store disc in its case.

Reference

- Sudden shift of the product from cold place to warm place might cause condensation on the optical lens causing malfunction. In this case, use after waiting 1~2 hours while power is applied to the unit.

How to clean the disc



- Clean the disc from inside to outside.

Reference

- Do not use thinner, benzen, commercial detergent, alcohol, electrostatic-preventing spray which might cause damage the disc.

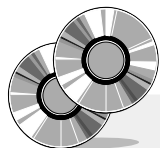

Contents

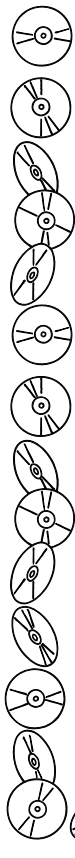

- Important Information** 2
- Important Safety Instructions** 3
- Information about Disc** 6
- How to care and store disc** 7
- Description** 10
 - Front Panel 10
 - VFD Display 11
 - Rear Panel 12
 - Important Safety Instruction When using DC IN jacks 13
 - Accessory 13
 - Remote controller button 14
 - Installing Batteries in the Remote controller 16
 - Using the Remote controller 16
 - Battery Handling Precaution 16
 - Remote controller handling precaution 16
- Connection** 17
 - Connecting to a TV/MONITOR 17
 - Connecting to a Dolby Digital Amp 18
 - Connecting TV antenna/TV cable 19
- Before playing Your DVD Disc** 20
- Playing a DVD disc(DVD/CD)** 21
- Playing a MP3 file** 22

- Disc Menu** 23
- Setting DVD** 24
 - Setting up Language 25
 - Setting up Video item 27
 - Setting up Audio item 29
 - Setting up the Parental Control 31
- Selecting Audio languages with the unit in play mode** 33
 - To select Audio Language 33
 - To select Subtitles Language 34
- Confirming Screen Display** 35
- Scanning Screen or Song** 37
- Slow/Divided motion** 38
- Repeating Playback** 39
- Enjoying magnified screen and Changing Camera Angles** 41
- Searching to the Desired Screen/Song** 43
- Playing a JPEG file** 45
- Setting TV** 46
- Specification** 48
- Is there something wrong with DVD player ?** 49

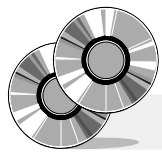

Description

Description

Front Panel

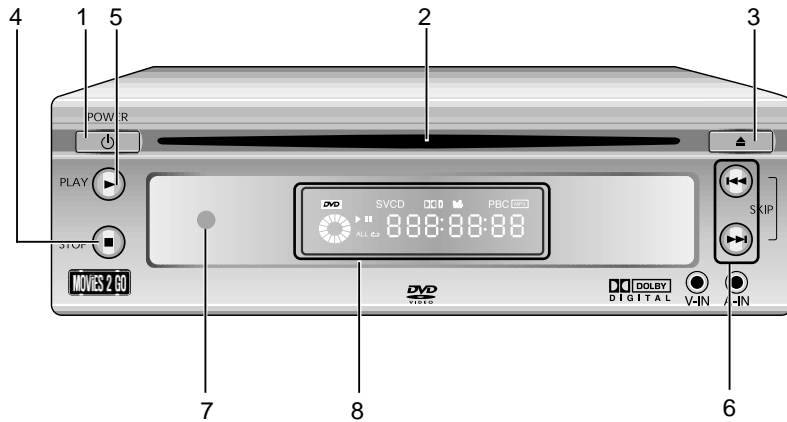

- ① **POWER** Turns the power on/off.
- ② **Disc slot** A Disc is inserted here.
- ③ **EJECT** A Disc is ejected by this button.
- ④ **STOP** Stop disc play
- ⑤ **PLAY** Begin disc play
- ⑥ **SKIP** Use to skip a chapter or track
- ⑦ **Remote Sensor** Receives signals from the remote control.
- ⑧ **Display Window** Displays information about the current state of the player and the disc.

VFD Display

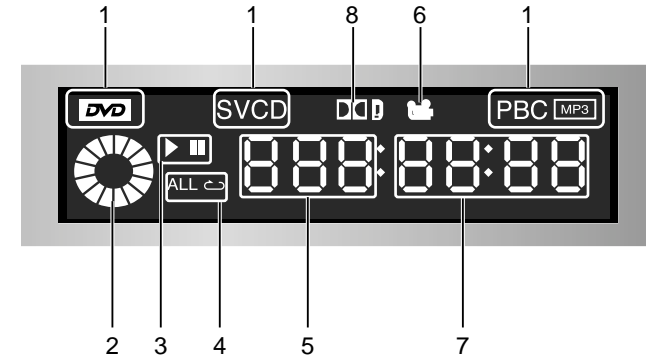

- ① **DVD/SVCD/VCD/CD/PBC/MP3** Indicates the type of the disc loaded in the disc tray.
- ② **Rotation** Rotates when the disc is spinning.
- ③ **Play/Pause** Indicates the current operation mode.
- ④ **Repeat/All** Indicates the current repeat play mode.
- ⑤ **Chapter/Track** Illuminates the chapter or track information of the disc playing.
- ⑥ **Angle** Indicates that the current disc being played can be viewed from multiple angles.
- ⑦ **Time** Indicates time information and displays information about operation.
- ⑧ **Dolby Digital** Indicates that the audio type of the disc under play is Dolby Digital.

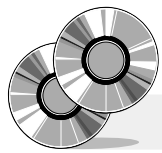

Description

Description

Rear Panel

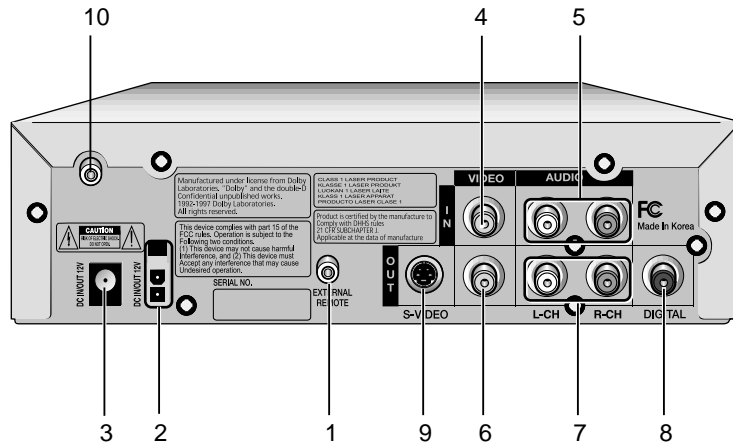

① EXTERNAL REMOTE CONNECTOR

Connect an external remote receiver(provided) to this jack.

② DC IN/OUT

Input/output from DC 12V power source.

③ DC IN/OUT

Input/output from DC 12V power source.

④ VIDEO INPUT

Connect a video cable to video output of auxiliary devices.

⑤ AUDIO INPUT

Connect a audio cable to audio output of auxiliary devices.

⑥ VIDEO OUT

Connect a video cable to this jack and to the Video Input jack on your TV or monitor.

⑦ AUDIO OUT

Connect the audio cables(left and right) from these jacks on your DVD player to the corresponding Audio Input jacks on your TV or monitor.

⑧ DIGITAL AUDIO OUT (Coaxial)

Use a coaxial cable(not provided) to connect your DVD player to a compatible Dolby Digital decoder.

⑨ S-VIDEO

Use the S-Video cable not provided to connect this jack to the S-Video jack on your an TV or monitor for a higher quality picture.

⑩ ANTENNA INPUT JACK

Connect TV Antenna to DVDplayer.

Important Safety Instruction When using DC IN jacks

1. When using this DVD player at home

Warning: Use the AC/DC Adapter (DC 12V, 2A) when playing the DVD player at home using an external power source.

2. When using this DVD player in the car

Connect to a 12vdc switched power source.

3. When connecting the DC power cable to power.

Warning: 1. Unplug the DVD player when you are not using it to prevent electric discharge.
2. Do not connect the DC power cable directly to the car battery directly.

Accessory

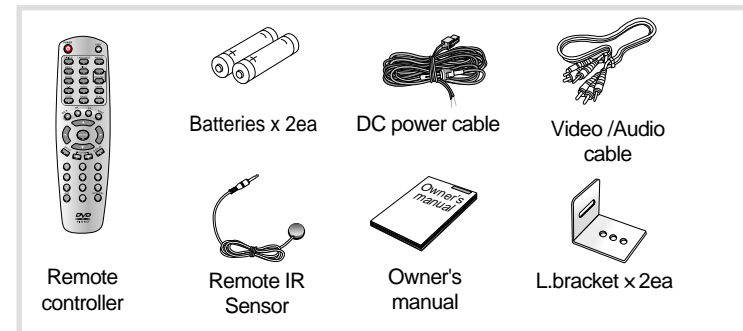

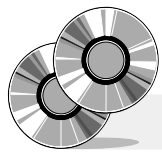

Description

Remote controller button

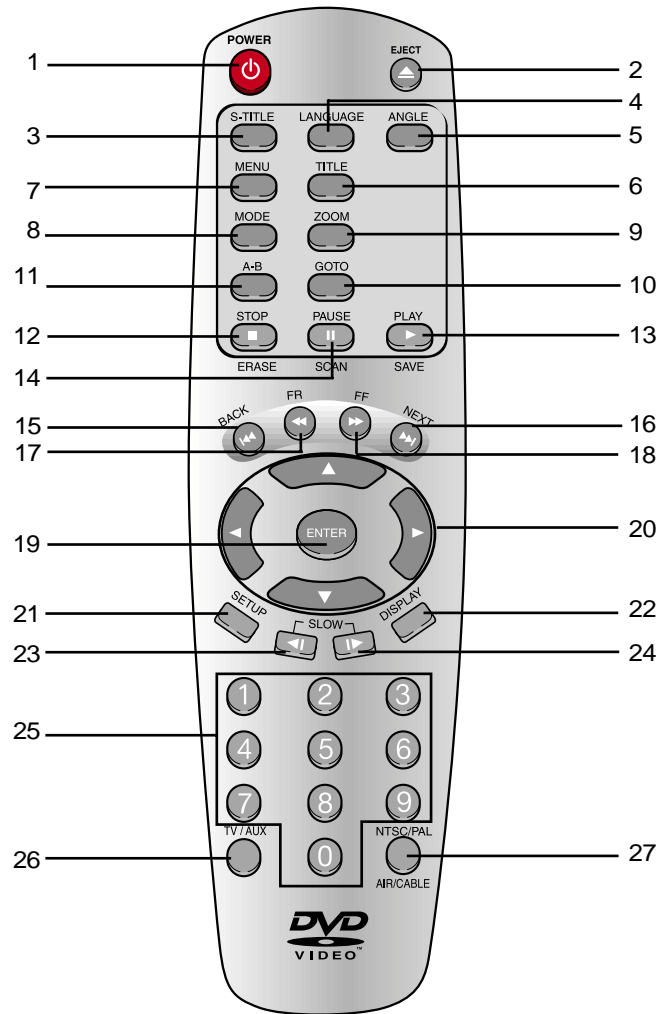

- 1. POWER**
Use to turn the DVD player on or off.
- 2. EJECT**
Use to insert or eject a disc.
- 3. S-TITLE**
Use this button to choose subtitle languages. (only when the disc supports various language subtitles).
- 4. LANGUAGE**
Use this button to choose language (only when the disc supports various language options).
- 5. ANGLE**
Use to access various camera angles on a disc (only when the disc supports multiple camera angles).
- 6. TITLE**
Displays the titles on the disc under play.
- 7. MENU**
Shows the root menu of the DVD under play. Show the menus of the disc under play and choose air channel or cable channel under TV mode.
- 8. MODE**
Use this button to choose playmode or repeat mode.
- 9. ZOOM**
Enlarges the picture.
- 10. GOTO**
Use to directly access the track or chapter of the DVD.
- 11. A - B**
Repeats the selected segment.
- 12. STOP, ERASE**
Stops disc play.
Erase TV channel under TV mode.
- 13. PLAY, SAVE**
Begin disc play.
Memory TV channel under TV mode.
- 14. PAUSE, SCAN**
Use this button to pause on a scene.
Auto Channel Scanning under TV mode.
- 15. BACK**
Move to the previous chapter(DVD) or track(CDDA, MP3).
- 16. NEXT**
Use to move to the next chapter(DVD) or track(VCD,CDDA, MP3).
- 17. FR**
Reverses through the disc form 2X to 20X faster.
- 18. FF**
Forward scan through the disc from 2X to 20X faster.
- 19. ENTER**
Use this button to confirm a selection.
- 20. ARROWS**
Use to move to the desired menu item.
Change channel under TV mode. (Up/Down)
Control adjust under TV mode. (Left/Right)
- 21. SETUP**
Use to set various functions according to individual preference.
- 22. DISPLAY**
Shows the time information about title, chapter, or track of the disc under play.
- 23. SLOW BACK**
Reverses through the disc from 1/2X to 1/7X faster.
- 24. SLOW FORWARD**
Forwards through the disc from 1/2X to 1/7X faster.
- 25. NUMERIC BUTTONS**
Use when selecting a password or direct access of chapters or tracks
- 26. TV / AUX**
Access the AV1 or AV2 inputs.
Change from DVD mode to TV mode.
(DVD→TV→AUX1(Rear input)→AUX2(Front input))
- 27. NTSC/PAL, AIR/CABLE**
Use to choose broadcasting methods (only when DVD player is not operating).

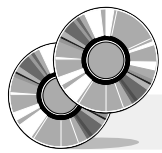

Description

Installing Batteries in the Remote Control

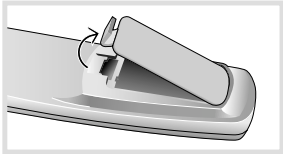

1. Press the tab and lift up the battery cover

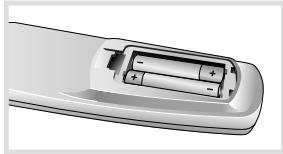

2. Insert new batteries and ensure that the polarity is correct when installing.

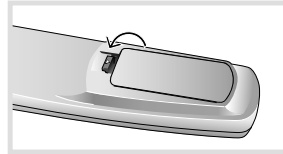

3. Slide and Close the battery cover.

Using the Remote Controller

The effective operating range of the remote control is 16 feet, and 30° left or right of the from the DVD/DIR receiver.

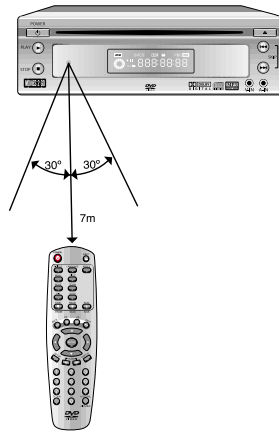

Battery Handling Precaution

- Incorrect use of the battery cause leakage or corrosion.
- Ensure that polarities are correct when inserting batteries.
- Do not expose to impose heat or fire. Do not disassemble or short-circuit the batteries.
- Ensure that exhausted batteries are not inserted into the remote control.
- Do not use different types of batteries together. Do not use old batteries together with new ones.
- If you don't use the remote controller for a long time, remove the batteries to avoid possible damage from battery corrosion.
- Replace the batteries with new ones if the remote controller does not operate or the operating distance comes to be short.

Remote control handling precautions

- Do not leave a remote control in a hot or damp place.
- Do not drop place a heavy object on the remote control.
- Do not disassemble remote control.
- Do not get wet.

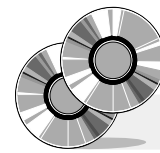

Connection

Connecting to a TV/Monitor

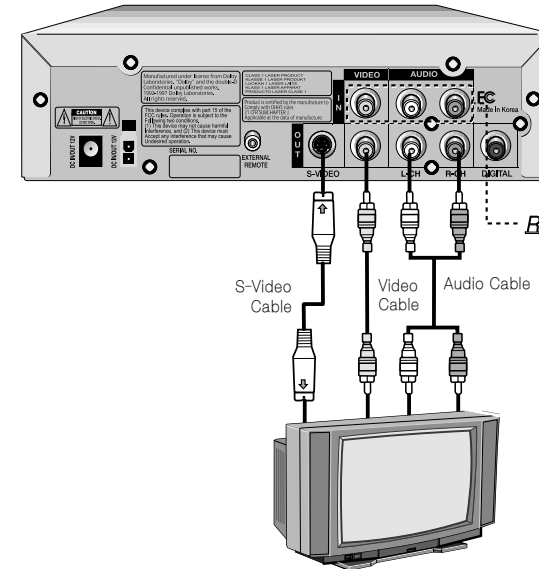

1. Connect the audio cables between the AUDIO OUT (L/R) jacks on the back of your DVD player and the corresponding Audio Input jacks on your TV/Monitor.
2. Connect the video cable between the VIDEO OUT jack on the back of your DVD player and the corresponding Video Input jack on your TV/Monitor. (If you have S-video jack on you TV/Monitor, connect this jack.)

Caution

- When you connect the DVD player to your TV/Monitor, be sure to turn off the power and unplug both units before making any connection.

- Connet the DVD player to your TV/Monitor directly.
- If you connect the DVD player to a VCR, the playback picture will be distorted because DVD video discs are copy protected.

Warning

- Do not set the Digital Audio Output of this DVD player to "PCM" unless you are connecting the Digital Audio jack of this DVD player to an AV decoder that has Dolby Digital decoding function.

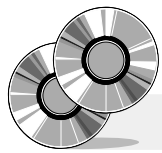

Before playing Your DVD Disc

When connecting to output componets, refer to "Connection" Chapter and output componets' manual,.
Turn on the power of the Amplifier, if it is connected.

First, turn on the power of TV, and press TV/Video button.

Press the **Power** button of DVD player



- "No disc" is displayed on the screen, following "Loading..."

- Reference**
- The player is automatically turned off, if "No disc" is on the screen for 8 minutes.
 - If ⏻ is on the screen when you pressed certain button, it means that this button is not used in this disc which is being played.

- Caution**
- Do not move DVD player when it is playing. This may cause damages to the disc.
 - Be sure to press  button to eject disc.
If you eject disc by force, disc may be damaged.
 - Do not insert any other object than disc in the slot.
 - Certain function may not operate or operate differently depending on the disc.
In this situation, refer to the contents of the disc case.

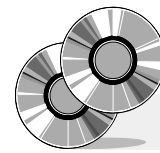



Playing a DVD disc(DVD/CD)









Insert the DVD disc

- Make sure that the disc's label is facing up.
- Sliding into the slot, the disc is automatically played

To stop Press the button  "(STOP)"

To stop temporarily Press the button  "(Pause)"

To resume again Press the button  "(PLAY)"

- Reference**
- The player memorizes the position you pressed the button  and if you press the button  the player resumes from the position you pressed the button  If you want to replay from the beginning, press the button  twice.
 - Press the button  to stop disc temporarily.
If you press the button  once again, it replays the disc one scene by one scene.
 - Refer to the page 34-35 to change language or subtitles while it is playing.
 - It may take several time in reading disc while it is playing, it is not a breakdown.
So wait for a while.

- Caution**
- Eject the disc when it stopped completely.
 - "No disc" is displayed on the screen, when you inserted disc upside down, damaged disc, and other unplayable disc.
 - "REGION ERROR" is displayed on the screen, when regionally unmatched disc is inserted.

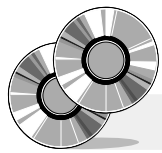



Playing a MP3 file



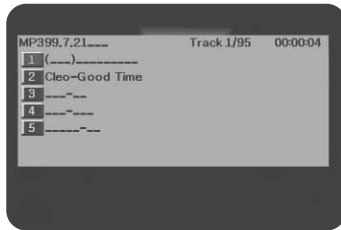

Insert the MP3 disc.

- Make sure that the disc's label is facing up.
- Sliding into the slot, the disc is automatically played





To stop Press the button  "(STOP)"

To stop temporarily Press the button  "(Pause)"

To resume again Press the button  "(PLAY)"

To replay a song you want

1. Press the button  after choosing a song (track) you want by using Arrow button. (▲▼◀▶) Then the selected song you selected will start automatically.
2. You can replay the song directly by entering the number of the song.
 - 14 tracks are displayed on the screen. If you want see more tracks, use the button ◀▶.
 - Press the button   to enjoy next or previous song.
 - You can enjoy song in another folder by using the button Menu.
3. The Button(FR/FF) moves to the Directory folder when it is pressed.

※ About MP3

- MP3 file must be formatted by ISO 9660 or JOLIET
- The file name of MP3 can not use particular letters.(\,/,*,!,",<,>|...)
- You can not record copy-protected MP3 file
- You may not play certain MP3 disc depending on the recording condition.

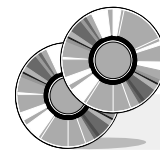

Disc Menu

You can select the following menu when the menu is recorded in discs.

To display recorded menu in disc DVD

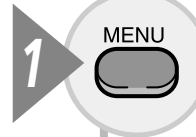

Press the **MENU** button

- The menu recorded in discs appears.
Menu appears differently depending on discs.
- ON/OFF of PBC function are selected repeatedly each time you press the button (Menu)
- CD does not have disc menu function.

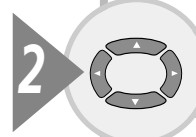

Press the ▲▼◀▶ buttons to move to item you want, and press the **ENTER** button.

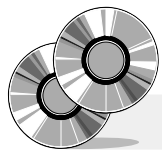

Setting DVD

The picture which you can set up various menu in advance appears after pressing the button(SETUP) with the unit in Stop mode. The information about the picture is as follows.

1 Press the **SETUP** button with the unit in Stop mode.

- following picture appears

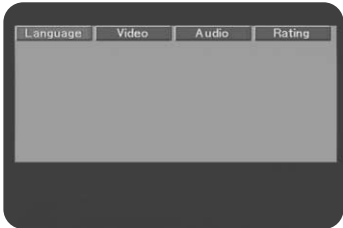

- **Setting up language**
You can set up text language, subtitles, Audio language, disc menu language, menu index, factory mode.
- **Setting up Screen**
You can set up the size of screen, broadcasting method.
- **Setting up Audio**
You can set up the digital/analogue out method and the volume of analogue audio out.
- **Setting up Parental Control**
You can set up the parental control level

Press the button ◀ ▶ to move each menu.
Press the button () to choose menu you want.

2 Press the ◀ ▶ buttons to move to menu you want and press the **ENTER** button.

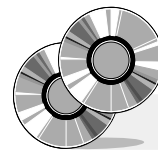

Setting DVD

Setting up Language

You can display OSD, subtitles or listen audio by language you want.

1 Press the **SETUP** button with the unit in Stop mode.



2 Press the ◀ ▶ buttons to move to Language Setting Menu and press the **ENTER** button.



- **OSD Menu** when selecting menu language of DVD player
- **Subtitle** when selecting subtitles.
when select "Auto", it is set up as the first recorded language.
- **Audio** when selecting language you listen from speakers.
- **DVD Menu** when selecting language of each menu recorded in disc.
- **Default** when resetting at the factory send-out condition.

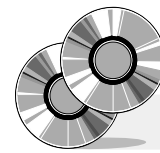

Setting up Video item

You can set up about screen as following.

3

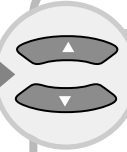

Press the ▲▼ buttons to move to Language Item and press the **ENTER** button.

- Languages you want to select appear.



4



Press the ▲▼ buttons to select Language and press the **ENTER** button.



Press the button  to exit from the SETUP screen.

Reference • The selected language does not appear in menu even if you followed above instruction, if selected language is not recorded in disc.

1



Press the **SETUP** button with the unit in Stop mode.



2



Press the ◀▶ buttons to choose Screen menu and press the **ENTER** button.



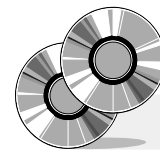

3



Press the ▲▼ buttons to set up item and press the **ENTER** button.

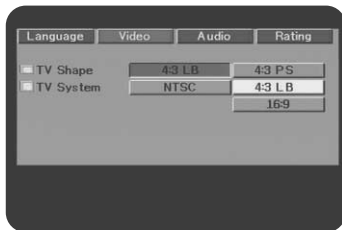

TV Shape

- 4 : 3 PS : You can watch 4:3 screen, but up and down side of screen is blackened.
- 4 : 3 LB : You can watch only the middle part of 4:3 movie.
- 16 : 9 : You can watch the screen at 16:9 ratio.

TV System

- NTSC : When connecting to TV with NTSC method.
- PAL : When connecting to TV with PAL method.
- Auto : Automatically selected depending on disc.

4



Press the ▲▼ buttons to item you want and press the **ENTER** button.

Press the button  to exit from the SETUP screen.

Setting up Audio item

You can set up as following depending on the connected Audio speaker.

1



Press the **SETUP** button with the unit in Stop mode.



2



Press the ◀▶ buttons to choose Audio Setting and press the **ENTER** button.



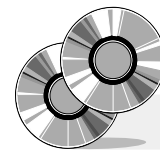

Setting DVD

3



Press the ▲▼◀▶ buttons to set up item and press the **ENTER** button.

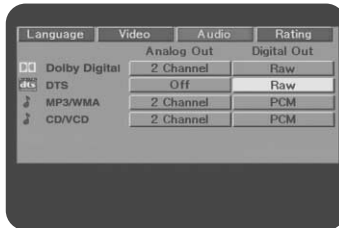

Dolby Digital Set up PCM of Digital out at "Raw" in the case of being connected to Dolby Digital Amplifier.

Press the button  to exit from the SETUP screen.

Setting up the Parental Control

This setting prohibits children from viewing inappropriate discs.
You can grade by 8 rating levels.
It works with DVD discs that have been assigned a rating.

1



Press the **SETUP** button with the unit in Stop mode.



2



Press the ◀▶ buttons to choose Parental Control and press the **ENTER** button.



3



Press the ▲▼ buttons to move to Password item.

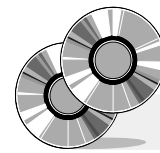

Selecting Audio languages with the unit in play mode.

4 **0 ~ 9** Enter pass word with **Numeric** buttons.

Memorize the password. In case you forget the password, this function is not working. Key icon on the screen does not open if not matched with password.

5 **▲ ▼** Press the **▲ ▼** buttons to move Parental Control Menu.

6 **ENTER** Press the **ENTER** button to select grade you want.

Parental Control rating changes each time you press Enter button
If you select Rating Level 6, Rating Level 7,8 does not replay.
The bigger the number is, the closer to adult the disc is.



To select Audio Language

1

LANGUAGE



Press the **LANGUAGE** button to change Audio Language(DVD).



- You can select various language Kor, Eng by pressing the LANGUAGE button (DVD), if disc has audio information.

Reference

- Audio Language index may differ depending on disc.
- One disc can record maximum 8 languages.
- Set up audio language in "SETTING DVD" chapter if you want a same language each time you replay DVD

Selecting Audio languages with the unit in play mode.

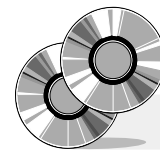

On Screen Display

Screen display may differ depending discs.

To select Subtitles Language

1

S-TITLE



Press the **S-TITLE** button to change subtitles.



- You can select various subtitles Kor, Eng, Jap- by pressing the S-TITLE button (DVD), if disc has subtitle information.
- Turn off subtitles by pressing the S-TITLE button, if you do not want subtitles.

- Reference**
- Subtitles indication may differ depending on disc.
 - One disc can record maximum 32 languages.
 - Set up subtitles in "SETTING DVD" chapter if you want a same subtitle language whenever you replay DVD

- Reference**
- Audio Languages/Subtitles may not operate depending on disc
 - This function does not operate with the unit in pause mode.
 - This function operates with the unit in play mode.

CD

1

DISPLAY



Press the **DISPLAY** button.

The first screen shows the elapsed time and total time of the present track.



2

DISPLAY



Press the **DISPLAY** button once more (CD).

This screen shows the elapsed time and total time of disc



Confirming Screen Display

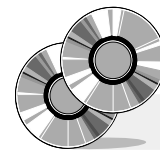

Scanning Screen or Song

DVD

1

DISPLAY



Press the **DISPLAY** button once more.

The screen shows all information about disc.



This screen appears right after loading when playing CD title. The total running time is displayed on screen when pressing the "Display" button. The present lapsing time is displayed when pressing the "Display" button.

● DVD

The elapsed time and total time of title is displayed.

The present track number, present track lapsing time, present track total running time are presented.

2

DISPLAY



The current title, chapter number angle status, audio track and subtitle selection.

3

DISPLAY



Press the **DISPLAY** button once more, Display indicator disappears.

1



Press the button (**BACK, NEXT**).



When you press the **BACK** button

- Moves to beginning of the present chapter/track.
- If you press once more, it moves to the previous chapter/track.



When you press the **NEXT** button

- Moves to the next chapter/track.

To Scan video or CD tracks (DVD/CD)

1



Press the button (**FR/FF**).

Play speed changes in the sequence of 2X, 4X, 8X, 20X.

- Press the **PLAY** button to play at normal speed.
- You can not listen sound at fast Playback.
- Fast playback does not operate with MP3's.

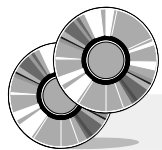

Slow/Divided motion

To playback Slow motion.



Press the **SLOW** button.

When you press the **SLOW** button

Play speed changes in the sequence of 1/2X, 1/4X, 1/6X, 1/7X each time pressing the SLOW button.

When you press the **SLOW** button

Reverse Play speed changes in the sequence of 1/2X, 1/4X, 1/6X, 1/7X each time pressing the SLOW button.

- Press the **PLAY** button to play at normal speed.
- You can not listen sound to audio at slow Playback speeds.
- Slow Playback does not operate while playing CD/MP3.

To Scan Each scene.

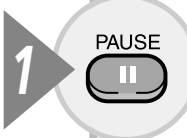

Press the **PAUSE** button with the unit in the Pause mode.

You can step frame by frame each time the **PAUSE** button is pressed.

- Press the **PLAY** button to play at normal speed.

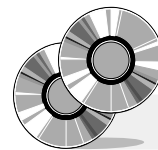

Repeating Playback

To repeat a chapter, title, or track (DVD/CD)

Use this button to repeat a chapter, title, or track

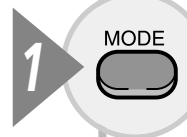

Press the **MODE** button.

Play mode Menu appears on the screen.

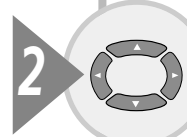

Press the **▲▼** buttons to highlight the Repeat option, and press the **ENTER** button.



- **DVD**
 - Off : When you do not want to repeat playback
 - Title : when you want to repeat the present title
 - Chapter : when you want to repeat the present chapter.
- **CD**
 - Off : When you do not want to repeat playback
 - Track : when you want to repeat the present track.
 - Disc : when you want to repeat the present disc.

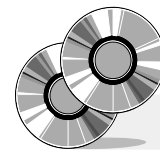

To repeat a particular section

1



Press the **A-B** button at the position from which you want to repeat.

Play mode Menu appears on the screen.



- Press the A-B button to set the starting point A and then press the A-B button once more to set the end point B. The selected segment (A-B) will be played repeatedly.
- To cancel the repeat operation. Press the A-B button again.



Enlarging the picture

You can enlarge the picture up to 3X the normal size.

1



Press the **ZOOM** button in Play or Pause mode.

- (🔍) is displayed on screen and the screen ratio is displayed on screen.
- Each press of the ZOOM button enlarges screen in the following sequence 4/3X - 3/2X - 2X - Off



2



You can move the enlarged picture the **▲▼◀▶** buttons.

Enjoying magnified screen and Changing Camera Angles

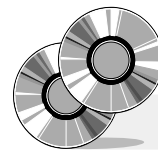

Searching to the Desired Chapter/Track/Time

Change Angle (DVD)

When a DVD contains multiple angles of a particular scene, you can select the Angle function.

1  Press the **ANGLE** button.

- The Angle icon() is present, and the maximum number of viewing angle's.

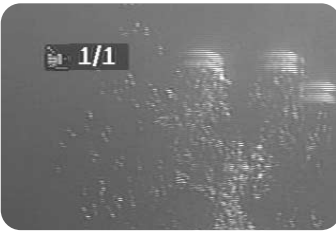

- Press the ANGLE button to, select the Camera Angle you want
- If the maximum number of screen is 1, the Camera Angle does not change.

You can find the desired time, title, chapter, track.

To scan by time (for example by 1 hour 5 minutes 15 seconds)

1  Press the **GOTO** button.

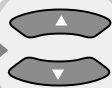

2  Press the **▲▼** buttons to the move to the time item.

3  Press the buttons '1, 0, 5, 1, 5' using the numeric buttons, and then press the **ENTER** button.



Searching to the Desired Screen/Song

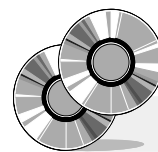

Playing a JPEG file

To scan by title, chapter

1

GOTO



Press the **GOTO** button.



2

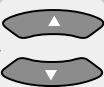

Press the **▲▼** buttons to move to title/chapter item.

3



Press the buttons '1, 3' using the numeric buttons, and then press the **ENTER** button.

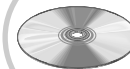

Insert the Disc.

- Make sure that the disc's label is facing up.
- Slide show begins from first picture automatically



1. You can enjoy a slide show by displaying 9 pictures at a time, by pressing the "Menu" button.
2. Choose the picture button you want by pressing the cursor buttons (▶, ◀, ▼, ▲)
3. You can move to the next/previous picture by using the NEXT/PREV button. You can also move to the picture directly by pressing the "Enter" button after pressing the numeric button.
4. The picture rotates 90, 180, 270 original when pressing the button
Slide show begins again as before if you press the play button
5. You can enjoy the 4/3X, 3/2X, 2X, 1/4X, 1/2X magnified/reduced picture by pressing the button "Zoom".

Reference

- Slide show can play 999 pictures.
- Slide show play at 10 seconds interval automatically.
- Slide show plays only JPG/JPEG files.
- The JPEG file name can not use some characters (\, /, :, *, !, ", <, >, | ...)
- Slide show may not play JPEG Disc's depending on the recording format.

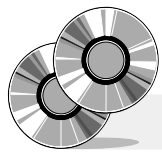



Setting TV

TV Channel : Air channel range 2~69ch
Cable channel range 01~125ch

Watching TV

1  Press the TV/ Aux button.



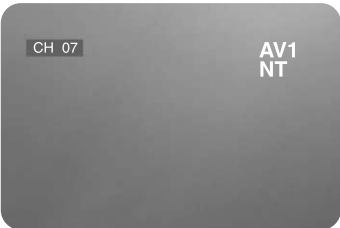

2  Press the Up/Down button or skip button on front of set to change channel.



3  Press the Left/Right button to adjust channel.

4 Press the Play button to enter the channel into memory. Press the stop button to erase the channel from memory.



5  Press the Pause button or hold the Play button on the front of set to enter channel into memory automatically.



- Channel adjustment
The function for adjusting channel, when channel reception is not good.

- Reference**
- Press the Aux button : DVD mode-----TV mode-----Aux mode
 - No control the button of set under Auto memory
 - Changing to DVD mode Automatically, when insert Disc under TV mode
 - Press the NTSC/PAL button to change from Air channel to cable channel.

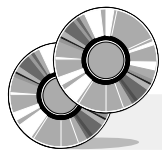

Specification

General	Power Requirements	DC 12V 2A
	Power Consumption	15W
Disc	Weight	1.33Kg, 2.93lbs
	Dimension	178(D) X 175(W) X 50(H) 7.00(D) X 6.88(W) X 1.9(H) inch
	Operating Temperature Range	0°C ~ +50°C, 32F ~ 122F
	Operating Humidity Range	30% ~ 80%
	Video Output	Composite Video :1.0 V p-p S-Video Luminance Signal : 1.0Vp-p(75 ohm)
Audio Output	2channel Left(1/L) Right (2/R) Output level : Analog Audio : 2.0 Vrms Digital Audio : 0.5V p-p	
	S/N Ratio	100dB
	Dynamic Range	90dB
	Total Harmonic Distortion.(THD)	0.05%

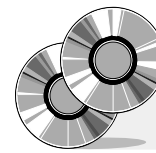

Is there something wrong with the DVD Player?

Contact the service center if same phenomenon appears, after taking following measures.

The picture is not seen on the screen while the disc is running, or the picture has poor quality and wavers.	<ul style="list-style-type: none"> • Ensure that TV is turned on. • Ensure that the power cord is plugged in completely. • Check if the disc is dirty or damaged. • Poorly manufactured discs may not operate.
The sound quality is poor.	<ul style="list-style-type: none"> • Check all connections.
Remote control does not work.	<ul style="list-style-type: none"> • Check if remote control is not pointed at the remote sensor of the DVD player or too far from the DVD player. There is an obstacle between the remote and the DVD player • Check if the batteries in the remote control are exhausted.
Video or Audio does not operate, or disc is ejected after 2 ~ 5 seconds.	<ul style="list-style-type: none"> • If the DVD player is moved from cold place to warm place moisture may condense in side causing poor operation. Do not use DVD player for about 1 ~ 2 hours. (After moisture evaporates, you can use the DVD player.)
The DVD player does not work.	<ul style="list-style-type: none"> • Check if a disc is inserted. • Check if the voltage is present. • Check if the disc is inserted label facing up. • Check if disc has matching regional code with DVD player.

Is there something wrong with the DVD player?

No sound	<ul style="list-style-type: none">• Playing the unit in slow or scan mode there is no sound.• Check if it is connected and it is set up properly.• Check if disc is inserted upside down? (Insert disc label facing up.)• Is disc damaged or dirty (Clean the disc.)
DVD player does not work as it is set up initially.	<ul style="list-style-type: none">• Initial settings up may operate differently depending on DVD disc.
The Dolby Digital 5.1 channel sound does not operate.	<ul style="list-style-type: none">• You can enjoy Dolby Digital 5.1 channel sound by connecting to a Dolby Digital decoder and playing a DVD disc recorded in Dolby Digital 5.1 CH.
Audio language and Subtitles which are chosen does not operate.	<ul style="list-style-type: none">• Audio language and Subtitles only operate in discs recorded with the desired language.
Camera Angles does not operate in disc play	<ul style="list-style-type: none">• You can change Angles on screen with discs recorded by with multiple camera angles "  " mark is present on the screen.

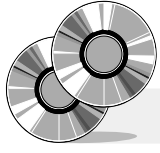

MEMO



12 MONTH LIMITED WARRANTY

Applies to AEC Mobile Video Products

AEC (the Company) warrants to the original retail purchaser of this product that should this product or any part thereof, under normal use and conditions, be proven defective in material or workmanship within 12 months from the date of original purchase, such defect(s) will be repaired or replaced with reconditioned product (at the Company's option) without charge for parts and repair labor.

To obtain repair or replacement within the terms of this Warranty, the product is to be delivered with proof of warranty coverage (e.g. dated bill of sale), specification of defect(s), transportation prepaid, to the Company at the address shown below.

This Warranty does not extend to the elimination of externally generated static or noise, to correction of antenna problems, to costs incurred for installation, removal or reinstallation of the product, or to damage to tapes, discs, speakers, accessories, or vehicle electrical systems. This Warranty does not apply to any product or part thereof which, in the opinion of the Company, has suffered or been damaged through alteration, improper installation, mishandling, misuse, neglect, accident, or by removal or defacement of the factory serial number/bar code label(s). THE EXTENT OF THE COMPANY'S LIABILITY UNDER THIS WARRANTY IS LIMITED TO THE REPAIR OR REPLACEMENT PROVIDED ABOVE AND, IN NO EVENT, SHALL THE COMPANY'S LIABILITY EXCEED THE PURCHASE PRICE PAID BY PURCHASER FOR THE PRODUCT.

This Warranty is in lieu of all other express warranties or liabilities. ANY IMPLIED WARRANTIES, INCLUDING ANY IMPLIED WARRANTY OF MERCHANTABILITY, SHALL BE LIMITED TO THE DURATION OF THIS WRITTEN WARRANTY. ANY ACTION FOR BREACH OF ANY WARRANTY HEREUNDER INCLUDING ANY IMPLIED WARRANTY OF MERCHANTABILITY MUST BE BROUGHT WITHIN A PERIOD OF 24 MONTHS FROM DATE OF ORIGINAL PURCHASE. IN NO CASE SHALL THE COMPANY BE LIABLE FOR ANY CONSEQUENTIAL OR INCIDENTAL DAMAGES FOR BREACH OF THIS OR ANY OTHER WARRANTY, EXPRESS OR IMPLIED, WHATSOEVER. No person or representative is authorized to assume for the Company any liability other than expressed herein in connection with the sale of this product.

Some states do not allow limitations on how long an implied warranty lasts or the exclusion or limitation of incidental or consequential damage so the above limitations or exclusions may not apply to you. This Warranty gives you specific legal rights and you may also have other rights which vary from state to state.

U.S.A. : AEC 150 MARCUS BLVD., HAUPPAUGE, NEW YORK 11788 1-800-645-4994

CANADA : CALL 1-800-645-4994 FOR LOCATION OF WARRANTY STATION SERVING YOUR AREA

128-6429D

Free Manuals Download Website

<http://myh66.com>

<http://usermanuals.us>

<http://www.somanuals.com>

<http://www.4manuals.cc>

<http://www.manual-lib.com>

<http://www.404manual.com>

<http://www.luxmanual.com>

<http://aubethermostatmanual.com>

Golf course search by state

<http://golfingnear.com>

Email search by domain

<http://emailbydomain.com>

Auto manuals search

<http://auto.somanuals.com>

TV manuals search

<http://tv.somanuals.com>