



AUDIOVOX
ELECTRONICS CORP.



Portable DVD/VCD/CD Player

Owner's Manual

PDVDNS



1-800-645-4994

Customer Service

Article Nr. 25070PD2000080

128-5944

IMPORTANT SAFETY CONSIDERATIONS - PLEASE READ FIRST

1. Read these instructions.
2. Keep these instructions.
3. Heed all warnings.
4. Follow all instructions.
5. Clean only with a damp cloth.
6. Do not block any of the ventilation openings. Install in accordance with the manufacturer's instructions.
7. Do not install near any heat sources such as radiators, heat registers, stoves, or other apparatus (including amplifiers) that produce heat.
8. Do not defeat the safety purpose of the polarized-type plug. A polarized plug has two blades with one wider than the other. The wide blade is provided for your safety. When the provided plug does not fit into your outlet, consult an electrician for replacement of the obsolete outlet.
9. Protect the power cord from being walked on or pinched particularly at plug, convenience receptacles, and the point where they exit from the DVD.
11. Only use attachments/accessories specified by the manufacturer.
12. Unplug this DVD during lightning storms or when unused for long periods of time.
13. Refer all servicing to qualified service personnel. Servicing is required when the DVD has been damaged in any way, such as power-supply cord or plug is damaged, liquid has been spilled or objects have fallen into the DVD, the DVD has been exposed to rain or moisture, does not operate normally, or has been dropped.

WARNING SYMBOLS IN THIS MANUAL

This user's manual employs four different symbols to indicate the different types of warning message:



indicates a warning or notice regarding product operation.



indicates to the presence of important operating and maintenance (servicing) instructions.



indicates of the presence of uninsulated dangerous voltage within the product's enclosure.



The double-square symbol indicates a classification of IEC 417 No.5172, to identify equipment meeting the safety requirements of DOUBLE INSULATION specified for Class II equipment. It can in no way be confused with the manufacturer's name or other identifications.

IMPORTANT SAFETY CONSIDERATIONS - PLEASE READ FIRST



LASER EMISSIONS WARNING

This product is fitted with a laser-emitting device. Make sure the device is shut down prior to opening player lid. Please follow the following precautions when operating. Failure to do so may result in fire, personal injury, or equipment damage.

1. Do not operate controls, make adjustments, or perform procedures other than as specified in the DVD drive installation guide.
2. Only an authorized service technician should effect repairs.
3. All DVD-equipped systems comply with appropriate safety standards, including IEC 825. The installed laser device complies with Class 1 government laser performance standards. This laser device does not emit hazardous light and is fully enclosed during user operation and maintenance.



OUTDOOR USE WARNING

To reduce the risk of fire or electric shock, do not expose this product to rain or moisture.



USING AN EXTERNAL POWER SOURCE

This product is sold with a power cord appropriate for accessing an external power source. Make sure to use only an appropriate external power source, as indicated on the electricity ratings label. If you are unsure regarding the type of power source in your area, consult an authorized service provider or the local power company. Refer to enclosed operating instructions for instructions regarding using batteries with this product.



BATTERY WARNING

The DVD player uses a NiMH battery pack as an optional item. If handled improperly, this battery pack poses a risk of fire or burns. Do not disassemble, crush, puncture, short external contacts, or dispose of the battery pack in fire or water. Do not attempt to open or service the battery pack. Replace only with a battery pack designed specifically for this product. Discard spent batteries in accordance with manufacturer's instructions.



ATTENTION

Il y a danger d'explosion s'il y a remplacement incorrect de la batterie. Remplacer uniquement avec une batterie du même type ou d'un type recommandé par le constructeur. Mettre au rebut les batteries usagées conformément aux instructions du fabricant.



LASER BEAM WARNING

CAUTION - Laser radiation when open and interlock defeated. DO NOT STARE INTO BEAM.



USE AN APPROVED POWER CORD

If a power cord was not included with your purchase or you have lost the power cord, you should purchase a power cord approved for use in your country and properly rated for product voltage and current requirements (refer to product electrical rating label). The power cord voltage and current rating should be greater than said ratings for the product. Furthermore, power cord wire must be a minimum 0.75mm²/18AWG with a recommended length between 5 and 6.5 feet (1.5 to 2 meters). Contact your authorized service provider regarding further questions about power cord selection and use.

CAUTIONS ON USING THIS PLAYER

Do not move the player during playback

During playback, the disc spins at high speed, so do not lift or move the player. Doing so may damage the disc.

When transporting the player

Be sure to remove the disc and close the lid when transporting the player.

Also slide the power switch to turn off the power, then unplug the power cord once "OFF" on the display window turns off and the power indicator (red) lights. Transporting the player with a disc loaded may result in damage.

Place of installation

Select a stable place near the TV or stereo system to which you are going to connect the player.

Do not place the player on top of a TV or color monitor. Install the player away from cassette decks or other devices, which are easily affected by magnetic forces.

Do not place objects on top of the player

Do not place any objects on top of the player.

Turn off the power when not using the player

Depending on the TV reception conditions, stripes may appear on the TV screen when the TV is turned on while the player's power is on. This is not a malfunction of the player or the TV. If this should happen, turn off the player's power. Noise may also be generated in the sound of a radio when the player's power is on.

Special note regarding use of player in vehicles

We strongly advise against using the player while driving.

Most countries and states have laws, which prohibit or severely restrict the use of the player in vehicles while driving.

Do not leave the player or the battery pack in places where

the temperature is extremely low or extremely high, such as inside the passenger cabin or trunk in midsummer. Doing so may warp the outer case or reduce the performance or quality of the battery pack.

When carrying on planes

Heed the airline company's rules.

When carrying in hospitals

Heed the hospital's rules.

"Dolby", "AC-3" and the double-D logo (DD) are trademarks of the Dolby Sound Laboratory (USA). Confidential unpublished works. ©1992-1997 Dolby Laboratories, Inc. All rights reserved. Manufactured under license from Dolby Laboratories.

DTS is a registered trademark of Digital Theater System (USA).

This product incorporates copyright protection technology that is protected by method claims of certain U.S. Patents and other intellectual property rights owned by Macrovision Corporation and other rights owners. Use of this copyright protection technology must be authorized by Macrovision Corporation, and is intended for home and other limited viewing uses only unless otherwise authorized by Macrovision Corporation. Reverse engineering or disassembly is prohibited.

It's forbidden by law to copy, broadcast, show, broadcast on cable, play in public, and rent copyrighted material without permission. DVD video discs are copy protected, and any recordings made from these discs will be distorted.

NOTE

Copy Guard Protection:

When the DVD player audio/video output is plugged into the A/V input jacks of a Video Cassette Recorder (VCR) using the audio/video cables, (red, white and yellow RCA jacks) poor picture quality may result (i.e. screen on TV getting brighter and dimmer) due to Macrovision copy guard protection contained on some DVD discs.

NOTE

When the DVD player is used with the battery as a power source, ensure that the battery has been charged for at least eight hours prior to connecting it to the DVD player. In certain situations connecting a low charged battery to the DVD player can result in a lock up of the DVD player Controls. If this occurs, unplug the battery from the DVD player and let the unit sit for 10 minutes before plugging into the AC Adapter or connecting a fully charged battery.



NTSC/PAL Viewing Area Standards

This player was configured to meet the broadcasting standard used in your country or area while in the factory. Under normal conditions, you need not adjust the PAL / NTSC setting. Most of Asia (excluding China) and the Americas use the NTSC broadcasting standard. Europe, Japan, and China / Hong Kong use the PAL broadcasting standard. If you use this product in an area using a standard different from your own, simply turn off the power, select the appropriate NTSC/PAL setting on the back of the player, then turn back on the power. Viewing disc programs on hook up TVs with different broadcasting standard will yield poor image quality.



[BLANK]

1

Thank You!

We appreciate your purchase of the portable DVD player. This product incorporates the latest digital audio / video (AV) technologies to give you the ultimate in listening and viewing pleasure. Before use, may we recommend you familiarize yourself with this user manual. The manual discusses player operation, the use of remote controller, system setup and player maintenance. If you are interested in a specific topic(s), please refer to the index on the next page. For quick start of using this player and gaining fundamental operating information about this player, you can refer to page 14 - Quick Starting Guide.

Table of Contents

1	Thank You!	10
2	Check Inventory	12
3	Quick Starting Guide	14
4	Player Functions	18
5	Player Controls	20
6	Remote Control Buttons	32
7	System Setup	46
8	Changing Settings During Play	58
9	Programmed Play	66
10	Connecting Audio / Video (AV) Peripherals	68
11	Setting the Password and Rating	74
12	Rechargeable Battery Installation and Use	78
13	User Precautions and Simple Maintenance	82
14	Specifications	85

2

Check Inventory

Before using this player, please make sure that you received all the following items, in good order, with your purchase. Some of the following items may not come standard with your player or be offered for optional purchase. Please contact your authorized retailer service regarding any questions.

Standard Bundled Items

1. DVD Player - one
2. AC/DC Power Adapter -one
3. Digital Audio Signal Cable - one
4. AV Signal Cable - one
5. Power Cord - one
6. Wireless Remote Control - one
7. AAA Batteries for Remote Control - two
8. Owner Manual - one

9. Car Power Jack Adapter

10. S-Video Signal Cable - one

11. Stereo Earphones

Optional Items

1. Carrying Bag

2. Rechargeable NiMH battery

3

Quick Starting Guide

! If you plan to power this DVD player using batteries, please first refer to page 78 of this manual.



1. Connecting to an External Power Source

Connect the power cord (provided with the player) to the side input plug and to a wall outlet. The use of any other power supply device may result in unstable voltage or power spikes that could damage the player. Do not use the provided power cord with any other device. The transformer on the end of the power cord will feel slightly warm during player operation or when plugged into a socket. When player is not in use, always unplug the transformer from the power source.





2. Plug in the AV signal wires

Plug the AV signal wires into the 3 AV output connectors located on the left-side panel. The red and white output plugs are configured such that the former provides right speaker audio, while the latter provides right speaker audio. The yellow plug provides video output.



3. Plug AV signal wires into peripheral equipment

Next, plug the other end of AV signal wires into your preferred peripheral equipment. More often than not, this will be a television set. Most TVs have input jacks for AV signal wires. As with output plugs, please make sure same colored wires connect to same colored jacks. Please refer to the instruction manual to determine how to set your TV to receive AV signal input from an external source.

To Next Page



4. Opening the Lid

Press the **EJECT** (▲) button to open the player's lid. Avoid pressing the **EJECT** button during play. During normal player operation, be sure press **STOP** before opening the lid.



While the lid is open, do not under any circumstances look directly at the laser reader mechanism to avoid accidental damage to your eyes.



5. Inserting a DVD Disc

Align the center of the DVD disc with the center hole of the DVD player. Press gently down on the DVD to snap the disc into place. Close the CD player cover. Make sure that the laser-emitting device is never bumped or contaminated by dust, etc. Try to keep the CD player cover closed as much as possible to seal internal components from outside contamination.

To Next Page



6. Slide the Side Power Switch On

At the left side of the unit, position the POWER slide switch to the ON/OFF position. This switch is spring-loaded and will return to the center position after it is released. Positioning the slide switch once again in the same direction will turn power OFF.



7. Press the ► (Play) Button

You are now ready to sit back and enjoy a great DVD experience. To stop play at any time, press the ■ (stop) button. Sliding the power button to ON/OFF will then shut down the power supply. Finally, return the protective cover to the closed position. In most cases, the DVD already inserted into the player will begin playing automatically when power is turned on. If you insert a DVD (and close the CD player cover) after turning on the power, the DVD should also begin play automatically.



After pressing the **STOP** button, unless the power is also disabled, the loaded disc should continue spinning.

4

Player Functions

1 AV Signal Output

To ensure the slimmest, lightest design possible, your player does not come equipped with an on board monitor screen. To enjoy the fullest effects of your player, you will need to connect the included AV signal wires into a television, amplifier, tape deck, or other AV peripheral equipment. To enjoy audio, however, you need simply to connect up the standard 3.5mm earphones.

2 Multiple DVD Format Compatibility

The player can play the following formats - DVD, SVCD (Super VCD), VCD, and music CD. The player automatically recognizes the appropriate format so all you need do is put in the disc, sit back, and enjoy.

3 Digital Signal Output

The player can output in full digital, allowing full enjoyment from DVDs with surround sound or DTS when the player is connected into an amplifier with digital decoding capability. The result, 5.1 channel, theater sound, is on par with the best movie theaters.

4 Automatic Power Saving Design

On battery power, when your player power has been shut off for over 10 seconds. While the power used in this mode is minute, it is still sufficient to keep the player on active standby, ready start immediately upon power on. Please refer to page 28 for further information.

5 Player Controls (1)

5

Player Controls (1)



1 PLAY Button

Pressing the **PLAY** (▶) button will immediately play the disc installed in your player. This button is also available on the remote control. Refer to page 39 for relevant instructions.

2 PAUSE Button

Pressing the **PAUSE** (||) button will pause play. If a music CD is paused, the music will temporarily stop. If a video disc is played the screen will temporarily freeze. Pressing the **PLAY** (▶) button will restore the media to normal play. While paused, the disc will still rotate but, as there are no contact parts, you need not worry that an extended pause will cause damage to the disc as happens with conventional magnetic music tape. However, do remember that while in pause, the player is still drawing the same amount of power as in play mode. This button is also available on the remote control. Refer to page 39 for relevant instructions.

3 STOP Button

Press the **STOP** (■) button will stop play, although the disc will remain in motion. Pressing the **PLAY** (▶) button soon after pressing stop will cause the player to pick up at the place just left off (i.e., memory play). Pressing the ■ button twice in a row will cause play to cease and the memory play function to be erased. This button is also available on the remote control. Refer to page 39 for relevant instructions.

❗ As the disc continues to spin even after the ■ button is pressed, please mind power consumption if your player is running on batteries.

4 FAST FORWARD and REVERSE Buttons

In case of playing back DVD, VCD or SVCD, press the **FAST FORWARD** (▶▶) or **REVERSE** (◀◀) button once to forward or reverse the picture at twice the normal output speed. Press twice to forward / reverse at quadruple normal output speed and three times to forward / reverse at eight times normal output speed. There is no need to continually press

the button to continue this function.

Press the **PLAY** (▶) button to return the picture to normal output. During fast forward / reverse sound will be disabled and video will speed forward or backward to facilitate easy search. Refer to page 39 for relevant instructions.

❗ Pressing and holding the **FAST FORWARD** or **REVERSE** button for more than one second will force the player to jump to the next / previous track. In other words, these two keys can behave the key **NEXT** (▶▶|) and **PREV** (|◀◀) on the remote control. See page 42 for more details.

5 EJECT Button

Pressing the **EJECT** (▲) button will cause the player lid to open to permit disc change. Under normal conditions, the lid should remain closed until a disc change is needed. When the lid is open, play functions are disabled.

Player Controls (2)



1 MENU Button

The vast majority of DVDs are designed to permit users to choose from various chapters or sections. Pressing the **MENU** button will allow you access to the menu screen containing the choices of available chapters/sections on the DVD. Scroll around the menu using the ▲, ▼, ◀ and ▶ buttons (see 3 on

next page) to choose the desired selection), then press **ENTER** to confirm. Some DVDs come with several levels of selection options. Follow on-screen instructions and select the desired item. This button is also available on the remote control. Refer to page 37 for relevant instructions.

❗ Pressing the **MENU** button for over than one second, the system will bring up the “ON SCREEN DISPLAY” menu, and allow you to make many broadcasting choices, please refer to page 58 for more control details.

2 TITLE Button

While in play, the DVD player will operate in synch with the installed DVD or VCD. Pressing the **TITLE** button during play of some discs will result in the name of the title being displayed. However, on some others, pressing **TITLE** will cause the main menu or publisher’s name to be displayed. Regardless of the display, follow subsequent on-screen instructions regarding buttons to be pushed next. The **TITLE** button is also available on the remote control. Refer to page 36 for relevant instructions.

3 ENTER Button and Direction Buttons

The **ENTER** button has two functions, namely confirming selections within setup mode (please refer to page 46, System Setup) and confirming a title selection after pressing the **TITLE** button and scrolling through the choices (please refer to the next section). The **ENTER** button is also available on the remote control. Refer to page 38 for relevant instructions.

4 RETURN Button

After pressing **SETUP** and making relevant selections within this mode, press **RETURN** to return to the next highest level within the mode. The **RETURN** button is also available on the remote control. Refer to page 36 for relevant instructions.

Player Controls (3)



1 Disc Viewing Window

The disc currently in play is visible through this window.

2 Play Mode LCD Screen

You can review various player functions displayed on this screen including disc track number, repeat settings, power status, etc. Please refer to page 29 for detailed information on function displays.

3 Remote Infrared Receiver Window

This IR window receives infrared signals broadcast from the player remote control. When using your remote, make sure this window is free of obstacles.

Player Controls (4)

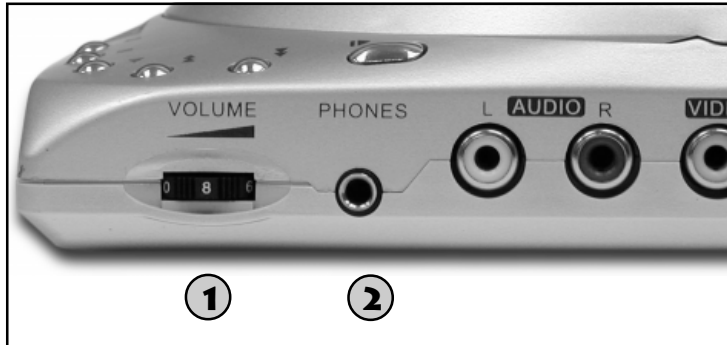

1 Volume Control Knob

This knob is used to control output volume to both the speaker and earphones.

Take care not to have the volume up too high while listening with earphones to protect your hearing and to prevent a distraction to concentration while concurrently performing other tasks. When audio is routed to other devices, the volume control no longer functions and volume adjustment must be assumed by a secondary device (such as amplifier).

2 Earphone Jack

The earphone jack on the player accepts any 3.5 mm standard earphone plug and delivers high quality stereo sound. You can choose any standard 3.5 mm stereo earphone which could easily be found on the market (or by attaching a 3.5 mm to 5 mm phone jack converter, you can enjoy even higher audio quality using a large, professional earphones.)

Player Controls (5)



1 AV Signal Output Connectors

This player's slim, lightweight profile does not permit an onboard monitor. When you want to view video output from your player, you will need to attach the standard RCA AV signal wires to a television, amplifier, tape deck, VCR, or other peripheral device.

The AV signal wire is included with your player. You may also use other standard RCA AV cables instead. Please note when installing the AV wires that the white, red, and yellow wires carry the left audio,

right audio, and video signal, respectively.

When audio output is fed through AV output wires, you may still listen to audio through your headphones.

NOTE

Copy Guard Protection:

When the DVD player audio/video output is plugged into the AV input jacks of a Video Cassette Recorder (VCR) using the audio/video cables, (red, white and yellow RCA jacks) poor picture quality may result (i.e. screen on TV getting brighter and dimmer) due to Macrovision copy guard protection contained on some DVD discs

2 S-VIDEO Output Connector

For higher quality video output, the player provides an S-Video output connector. Any device capable of accepting an S-Video signal can receive data through this port. Note that the S-Video port handles only the video signal. Audio channels must still be handled through the audio jacks.

Player Controls (6)



1 DC Power Jack

The player is supplied with an AC/DC adapter suited for home or long-period use. Plug one end into a power socket and the other into the DC IN power jack for immediate use.



CAUTION: The adapter supplied with the player must not be exchanged with an adapter supplied by a different maker due to the danger of unstable voltage supply and power surge.

2 Power Switch and System Lock

This switch turns the player on and off. Pushing the switch once to the left turns the player on. Pushing once again to the left turns power to the player off.

To avoid unintended control to the player, push the switch to the right (**HOLD** position) will lock the system. When the player is locked, pressing any key will take no effect to the player.

A note regarding the automatic power saving

Once the player has been stopped for over approximately five minutes, the system will enter “standby” mode and is prepared to respond immediately to a power up. In standby mode, power consumption is reduced to a minimum level to save power, the front LCD status window will read “**oFF**”. The player could be turned back on by pressing the “**POWER**” button on the remote control or by switching the **ON/OFF** button on the left side of the player.

In the case battery pack is used for operating the player and the standby mode is activated for 10 seconds, the system will then totally cut down the power consumption, the front LCD status window will now go out, showing no messages. The battery power is reserved.

 If you plan to suspend use of the player for a significant period of time, it is recommended that the power cord (or batteries) be removed to prevent unnecessary power drain.

Player Controls (7)

Play Mode LCD Screen

The Play Mode LCD Screen is located in the forward section of the player and is programmed to display several items of play data including chapter number, play time, repeat mode, battery status, charge mode, and so on.

When power to the player has been shut down, (please refer to page 27) this screen will display “**oFF**”.

When running on battery power and main power has been switched off for five minutes, the LCD screen will go fully blank. Please refer to page 28 for further information regarding automatic power saving features.



①

1 Disc Type

The player automatically detects the type of disc installed at any given time and will display such on the LCD screen - either DVD, VCD, or CD. If the player is currently in **Stop** mode, the disc type will flash.

5 Player Controls (7)

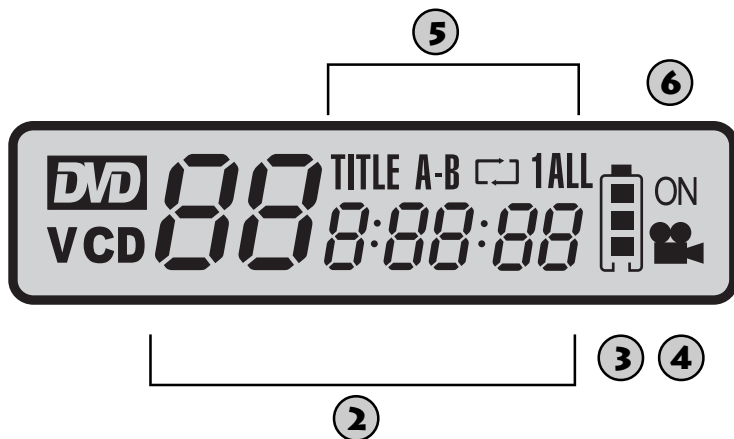

2 Chapter Number and Play Time

Regardless of the type of disc played, the chapter number and chapter time elapsed will be displayed (hours, minutes, seconds) in this area.

When play is paused, numbers in this area will flash.

3 Batteries Status

This symbol displays the level of reserves currently remaining in the installed battery. Please refer to

the chart below to determine reserve levels indicated by each display level.

Level.....	Reserve Power
3	Fully Charged
2	70%
1	30%
Flash	<10%

If the battery symbol is currently flashing, it indicates that battery reserves are at 10 percent or less. Recharging is recommended at this point. A battery kept at low reserves for an extended period of time is subject to damage and a shorter life span. During recharge, the battery symbol will flash all the way up until the battery is once again fully charged. Please refer to page 78 for a description of how to recharge as well as important information regarding battery usage and maintenance.

4 Angle Symbol

Some DVDs offer a selection of viewing angles for certain chapters. This symbol will light up to indicate that the current chapter has more than one angle from which to choose. Different angles can be chosen using the **ANGLE** button on the remote control (refer to page 44).

5 Repeat Mode Display

Once a repeat function has been chosen for a disc (please refer to page 35), the Repeat Mode Display will indicate which option has been selected (see below).

Display	Repeat Mode
TITLE	Title (DVD)
1	Current Chapter/Song
ALL	Entire Disc
A-B	Between Two Points

6 Virtual Surround Mode

Pressing the **Q SURROUND** key on the remote control will simulate the system's normal two channel sound output into a surrounded, spacial sound effect. When activated, an **"ON"** will be displayed in this area on the LCD screen.

You can fully enjoy the experience of three-dimensional sound effect with the earphone or external speakers. Please refer to page 43.

6

Remote Control Buttons

The remote control included with the player offers convenience as well as some special functions only accessible remotely. Therefore, please take care not to lose or damage your remote. Also, when you take your player out for a spin, don't forget to pack the remote as well!

To work the remote control, please make sure you are in front of the player, preferably not further than 22 feet (7 meters) away. Pickup is locked in within a sixty-degree radius. In small spaces, you may be able to bounce the signal off other objects effectively if a direct path is blocked.

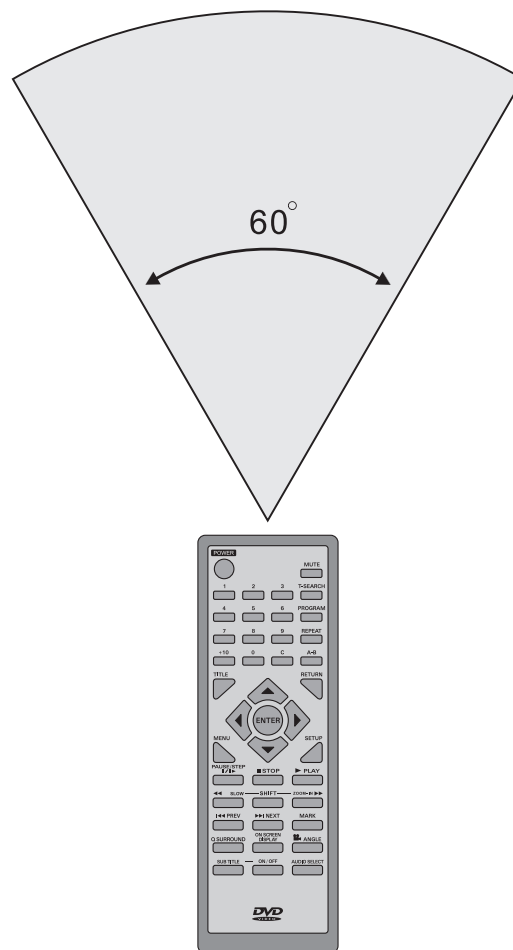

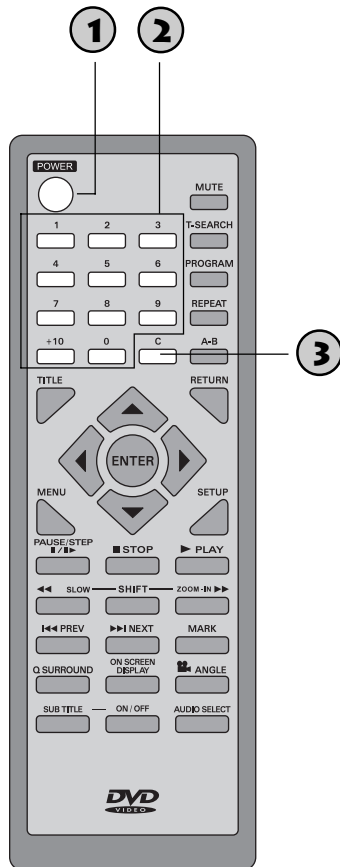

1 POWER Button

This switch turns the player on and off. When player power is off, it is in “standby” mode, awaiting instructions from the remote. Please refer page 28 for power saving tips.

2 Number Keys

Pressing the number keys will enter the pressed numbers into the player module. In most cases, such numbers are used to select disc chapters. For example, to select song number three on a disc, press **3**. Also, to select songs above the number 9, press **+10** and the appropriate number. To select, for example, number 46, press **+10** four times and then **3**.

When executing system setting commands, occasionally the entry of numbers is required. Examples include entry of a password number, setting language preferences, etc. Refer to page 42 for a more complete description of system setting operations.

3 C (Clear) Button

If you wish to get rid of the pop up menu, numbers entered in a pop up menu on the external TV screen, press the **C** button.

6 Remote Control Buttons

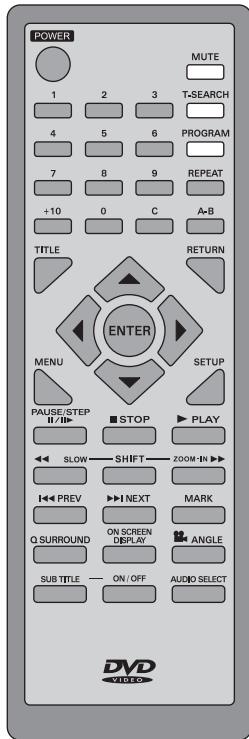

1 MUTE Key

Pressing the **MUTE** key will activate your player's mute function. While sound will cease on any played program, normal video images will continue to be broadcast. When the mute key is pressed, a **MUTE** message will appear in the upper right hand corner of the viewing monitor. To restore sound, press the **MUTE** button once again; an **UNMUTE** message will then appear on-screen.

2 T-SEARCH Key



The above icons will appear on the TV screen when you press the **T-SEARCH** key. This key is employed to execute a chapter search. Press the up or down (▲ or ▼) keys to change the number displayed next to the graphic to your desired chapter. Please note not all discs support the search capability.

3 PROGRAM Key

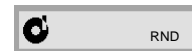

The above icon will appear on the TV screen when you press the **PROGRAM** key. This key is used to set the play order of various chapters (songs, segments) on an installed disc. This function is only available for VCD and CD discs. For playing back VCD, VCD's playback control (PBC) function must be OFF (refer to page 56). You can arrange and rearrange selections to your own preference by scrolling up and down using the ▲ or ▼ keys.

1. Random (RND): Songs / segments are played in a computer-selected random order.
2. Programmed (PRG): Songs / segments are played in a pre-set order. This order may be set by repeatedly entering chapter (song, segment) numbers. The LCD display on the player can be double-checked to make sure the proper numbers were received. Please refer to page 66 for further details regarding programming.

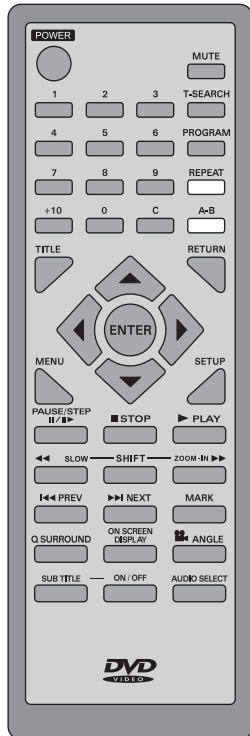

4 REPEAT Key



The above icon will appear on the TV screen when you press the **REPEAT** key. This key is used to set a repeat command. While the symbol is displayed, press the **▲** or **▼** key to select. You can choose between repeating a chapter (“C”, song / segment), the entire disc (“D”), and the track / title (“T”). In the event you do not wish to repeat, press the cancel (“C”) button.

5 A-B Key



The above icon will appear on the TV screen when you press the **A-B** key. This key is used to set play between two different points. Pressing the key once for the A value and once for the B will lock in the two values and permit continuous play between these two numbers. To cancel the two play repeat points, press the **A-B** button once again.

Important: If you are playing a DVD disc, the two points set will be automatically erased once the program crosses a Title divide or once the **MENU** key is pressed.

6 Remote Control Buttons

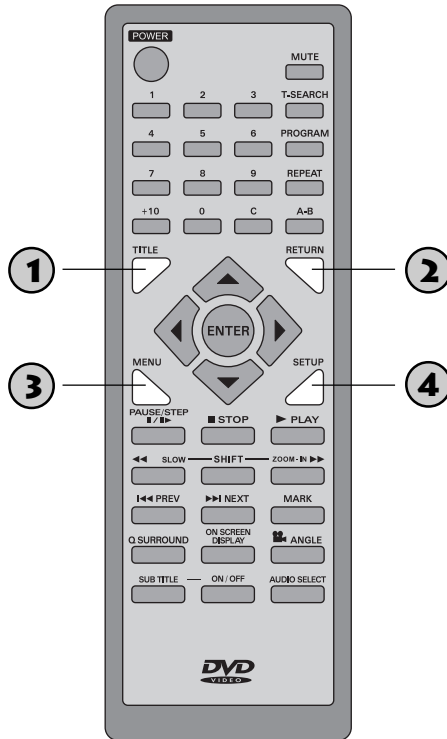

1 TITLE Key

Pressing the **TITLE** key brings up the DVD (and some SVCD) title screen. The majority of DVDs allow title selection and usually will permit selection at the next level down as well (e.g., chapters). Some DVDs also permit you to select language and sound preferences in this screen. Once in the title screen, use the scroll buttons to choose your preferences, then press **ENTER** to confirm choices and close out the screen. An equivalent button is also located on the player. Please refer to page 22 for corresponding buttons on the player.

2 RETURN Key

While programming settings, you will encounter many menu levels. Whether finished making your selection in a certain level or not, pressing on the **RETURN** key will take you to the level immediately above the current one. An equivalent button is also located on the player. Please refer to page 23 for corresponding buttons on the player.

3 MENU Key

Pressing on the **MENU** key will take you to the menu screen of a DVD. In this menu, based on different disc designs, you can choose titles / chapters and/or perform certain setting operations (e.g., language settings). Not all DVDs offer the same functions. What is available on any one disc depends upon the publisher. An equivalent button is also located on the player. Please refer to page 22 for corresponding buttons on the player.

4 SETUP Key

When the player is in stop mode, pressing the **SETUP** key will take you to the system setup menu. The setup menu permits access to a number of basic system variables. Please refer to page 46 for a more complete discussion of setup options.

6 Remote Control Buttons

1 Directional Keys

These four directional keys permit you to scroll through options in order to make selections. Please refer to page 46 for a more thorough discussion of scrolling operation.

These keys are also necessary to make program play selections once you are in the **MENU** screen of a DVD or VCD.

Furthermore, pressing the **ON SCREEN DISPLAY** button will display the options menu on the main monitor screen. Scroll through the menu to set your preferences.

Please refer to page 23 for corresponding buttons on the player.

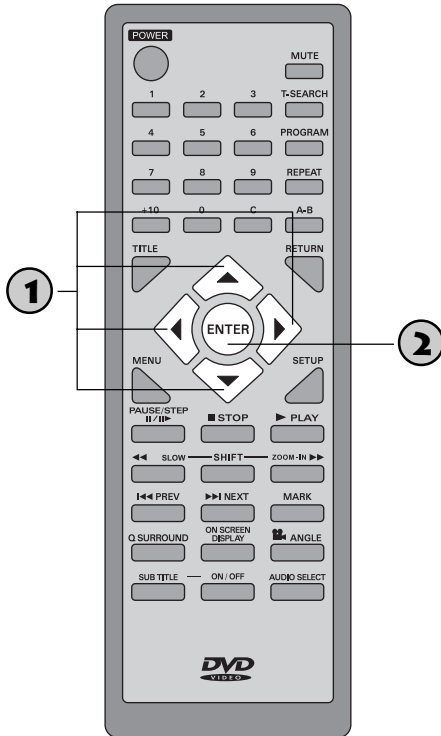

2 ENTER Key

Once you press the **SETUP** key, scrolled around \blacktriangle , \blacktriangledown , \blacktriangleleft , \blacktriangleright and made your selections, press **ENTER** to confirm choices. Please refer to page 23 for corresponding buttons on the player.

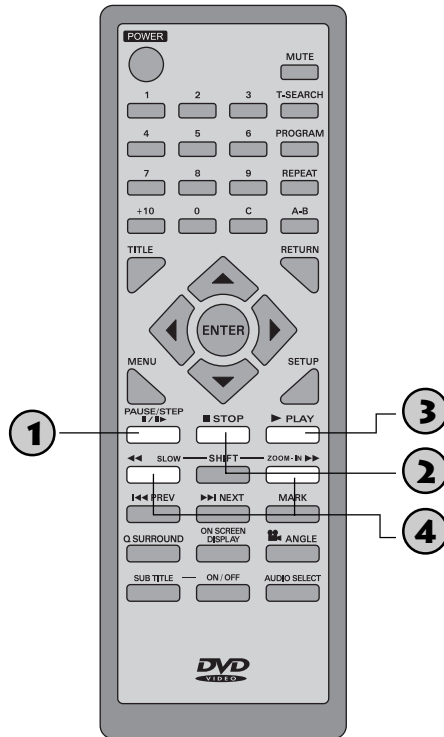

1 PAUSE/STEP Key

Pressing the **PAUSE/STEP** (|| / ||►) key will freeze play at its current position and sound will stop. If a video disc, the image will freeze on the screen. Pressing the pause key more than once will advance the image on screen frame by frame. Press the ► button to resume normal play. Please refer to page 29 for corresponding buttons on the player.

2 STOP Key

Pressing the **STOP** (■) key will cause play to cease immediately and returns to power-on welcome screen, although the disc will continue spinning at normal speed and draw the same amount of power. Please refer to page 21 for corresponding buttons on the player.

3 PLAY Key

Press the **PLAY** (►) key to play a disc. Please refer to page 20 for corresponding buttons on the player.

4 SEARCH Key

Press the ►► or ◀◀ to fast forward / reverse at twice normal speed through the program. Pressing these keys twice or three times will increase search speed to 4x and 8x, respectively. To restore speed to normal, press the **PLAY** key. Please refer to page 21 for corresponding buttons on the player.

6 Remote Control Buttons

Please note, you may use the SHIFT key in conjunction with these two buttons to provide additional feature functions. Please refer to the following sections for further instructions.

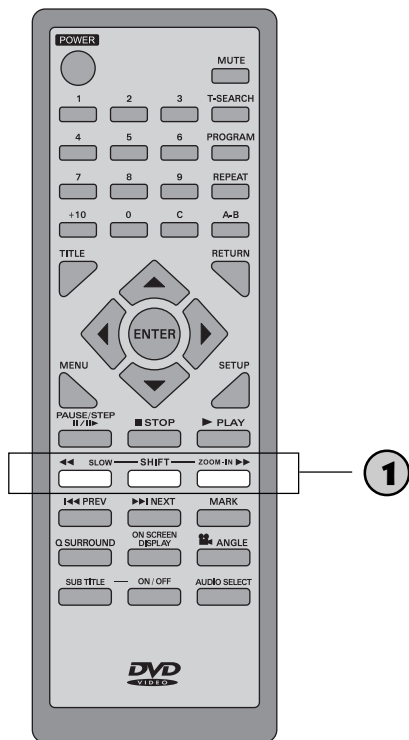

1 SHIFT Key

This key should be used in conjunction with either the ►► or ◀◀ keys.

SHIFT + ►► (Zoom-in)

After pressing the **SHIFT** key, press the ►► key once to switch the broadcast video image to 9x “Zoom” mode. At this time, a “ZOOM” message will appear at the upper right hand side of the screen. Selecting from 1 through 9 will display a full-screen image of one of the 9 screen sectors identified in the picture below. For example, pressing “1” will display sector one as shown below (upper right hand screen), while pressing “8” will display a close up of sector eight (lower middle screen).

The diagram on the next page shows the screen that will be displayed when the “1” key is pressed.

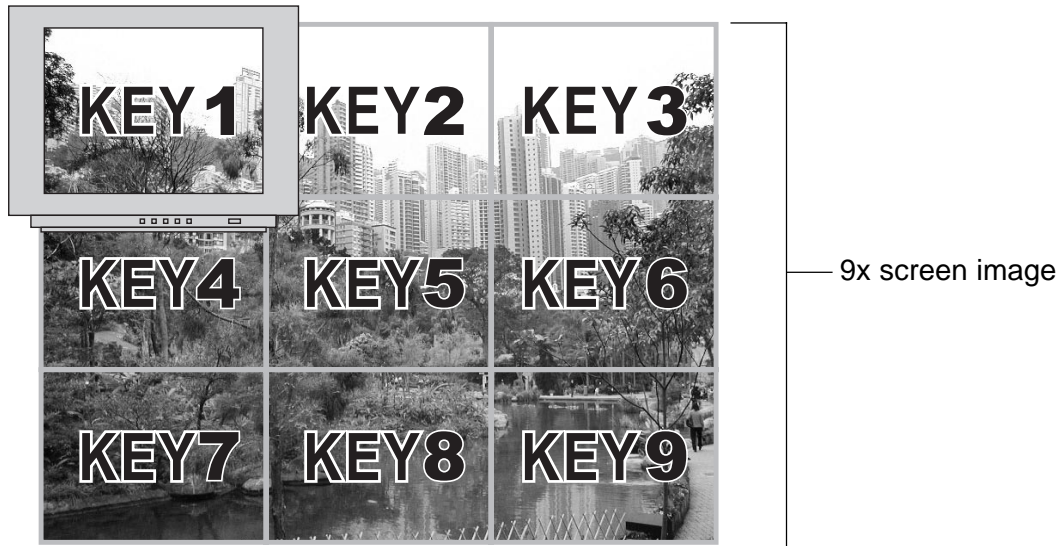

The default zoom screen is the center sector (number 5).

To cancel the zoom function, press the **SHIFT** key and then the ►► key.

SHIFT+ ◀◀ (Slow Motion)

Press the **SHIFT** key, then the ◀◀ key to switch the player into slow motion mode. Press once for 1/2 speed and twice for 1/4 speed play. This function is valid only for video discs and will not work with audio discs. In slow mode, the audio will be disabled.

To cancel slow play, press the **PLAY** key to resume normal speed play.

6 Remote Control Buttons

1 PREV / NEXT Key

Pressing the **PREV** (I◀◀) or **NEXT** (▶▶I) keys will cause a CD to skip to the song immediately after (or previous) the current. On a DVD or VCD, the player will skip to the immediately following (or preceding) chapter.

2 MARK Key



The above icon will appear on the TV screen when you press the **MARK** key. This command sets the start position for the memory function. While a disc is in play, press the **MARK** key to bring up the symbol above, then use the ◀ or ▶ keys to move the cursor over one of any of the five positions to the right of the symbol. Press **ENTER** to confirm.

The current play time will be recorded, up to a maximum of five positions. If you wish to skip forward to any one of the selected positions, again use the ◀ or ▶ to make your choice, then press **PLAY** or ▼ to begin playing the selection.

Position memory will be erased automatically when a disc is removed from the player.

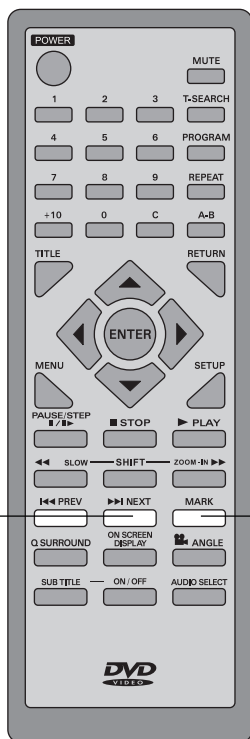

1 Q SURROUND Key

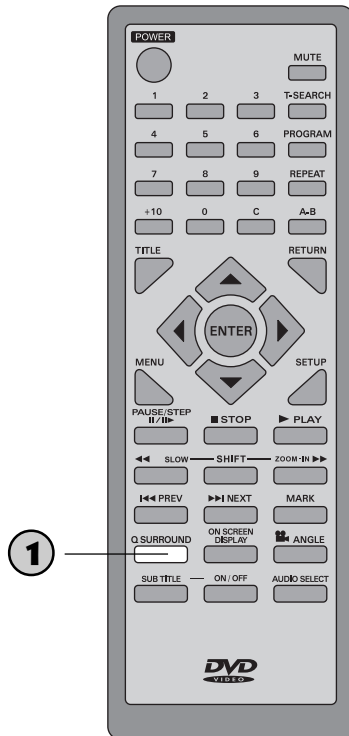

You can obtain a 3-dimensional, spacial sound effect by using the virtual surround simulator (Q Surround) employed in this player, when external speakers are connected to the player, you can enjoy full surround sound at home. The Q SURROUND function will take effect on DVDs, SVCDs and music CDs.

When the **Q SURROUND** key is pressed, a single-line message will shown on the external monitor indicates whether the Q SURROUND function is carried out. Continually press this key will toggle Q SURROUND effect on and off. You can also activate / deactivate the Q SURROUND function within the overhead icon when you pressed **AUDIO SELECT** or **ON SCREEN DISPLAY** keys. Please see corresponding sections for more control details.

* Please note the Q SURROUND function will not take effect on DTS encoded discs.

1 ON SCREEN DISPLAY Key

Clicking the **ON SCREEN DISPLAY** key will bring up the overhead control bar on the TV screen. This control bar allows you to perform many different setting functions. Pressing this key will not stop the play currently in progress so that you can immediately view the results of changed settings. Please refer to page 58 for more information regarding overhead control bar operations.

2 ANGLE Key

Some DVDs offer the option of viewing a scene / shot from several different angles. When this option is available on your DVD, pressing the ▲ or ▼ key will switch to the next available camera angle until the angle returns to default.

3 SUB TITLE ON / OFF Key

The above icon will appear on the TV screen when you press this key. Most DVDs have the option to view subtitled script. If a DVD offers this option, click on this key and scroll using ▲ or ▼ keys to select the language of choice (e.g., English, German). There is no “standard” set of language options with some DVDs offering only one. Please refer to DVD packaging to determine whether it offers subtitles and in which languages. You may find there are some films produced with subtitles already on-screen. Such films typically do not offer other

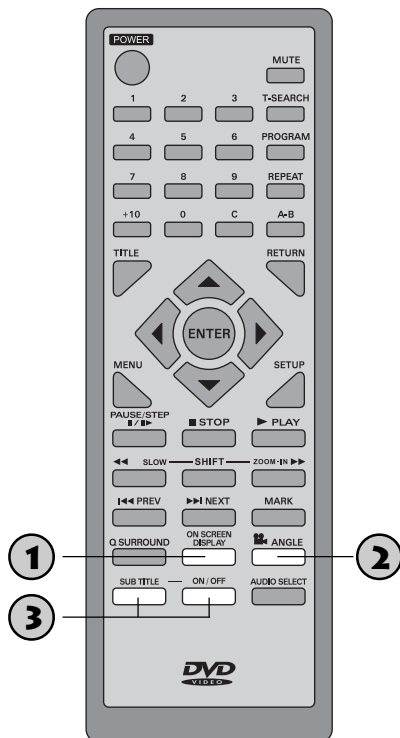

language subtitle options and the viewed subtitles cannot be removed from the screen. Pressing the **ON/OFF** key will enable or disable the subtitle display.

1 AUDIO SELECT Key

The **AUDIO SELECT** key is used to select the language in which the disc is broadcast, if different language options of the disc are available. This function is only available in DVD and VCD.

Once the **AUDIO SELECT** key is pressed, an overhead icon will appear on the remote TV screen, showing current language selection along with audio channel selection and Q SURROUND status. To change the language option, first use the ◀ and ▶ keys to move highlighted area to the audio display field, then use the ▲ and ▼ keys to change the value. Note the overhead control icon will change its shape when different discs were inserted, thus providing various controllible items. Please refer to page 58 for more information about the overhead control bar.

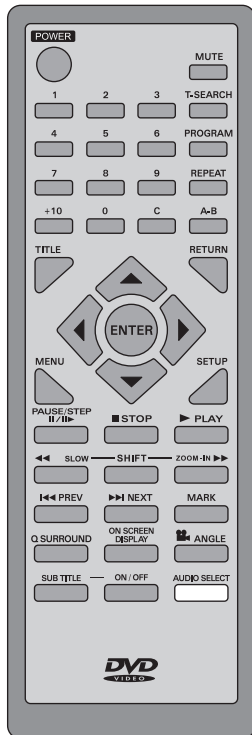

7

System Setup

When the player is stopped or no disc was inserted, press the **SETUP** key on the player or remote will bring up the System Setup menu. In the setup menu, many player function defaults could be defined, such as broadcast language, rating level, password and many others. The system setting can be seen on the TV connected to the player.

Once you have made changes to settings, the new variables will be saved and employed on all future DVD's played. However, some settings set in the Setup Menu could be temporarily overwritten during play by pressing the **ON SCREEN DISPLAY** key. Please see the next chapter for more information regarding temporary setting changes. If no setting changes are made within two minutes after the Setup key is pressed, the system will return automatically to the main screen.

ON SCREEN MENU / Language Select

The Setup Menu incorporates six sections, with the first allowing language selections. Use the up and down cursor keys to scroll through and select your preference. Once finished, press **ENTER** to confirm and go on to the next menu section.

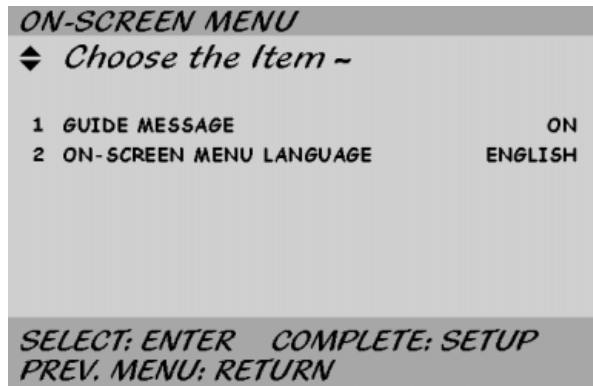
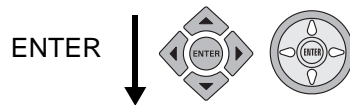
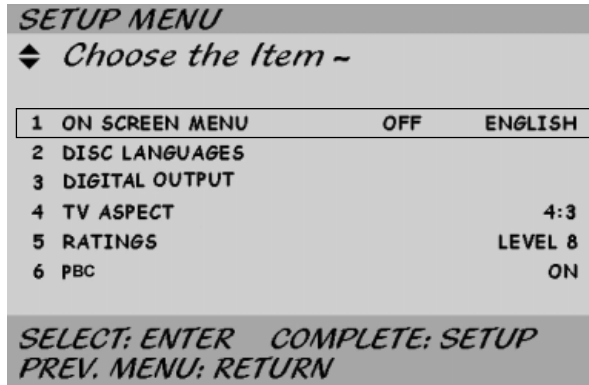

1 GUIDE MESSAGE: [ON / OFF]

Scroll ▲ or ▼ to the Guide Message option, press **ENTER** and select whether your preference is to have this option on or off. When finished press **RETURN** on the player or remote control to return to the immediately preceding menu level. Press **SETUP** to extricate yourself from the setup menu altogether.

ALL

2 (ON-SCREEN MENU LANGUAGE): [ENGLISH / CHINESE]

Scroll ▲ or ▼ to this option and press **ENTER**. This option allows you to change the language used to display information. Scroll to the display language of choice, then press **RETURN** to select and return to the immediately preceding menu level. Press **SETUP** to exit from the setup menu altogether. The following examples all show the screen in English display mode.

ALL

Select Disc Languages

The second of the six sections in the Setup Menu is entitled **DISC LANGUAGES**. Use the up or down cursor to scroll to this section and press **ENTER** to enter this screen.

DVD

1 AUDIO LANGUAGE:

Scroll up or down to the **AUDIO LANGUAGE** selection, then press **ENTER**. Selecting Français, English, or ORIGINAL will give that language priority when playing a disc with language options. Also, you may enter a language code to make that language the audio language default choice. Once set, please press **RETURN** to select and return to the immediately preceding menu level. Press **SETUP** to exit from the setup menu altogether.



If your selected audio language is not available for the disc currently played, the player will automatically provide audio in the disc's default language.

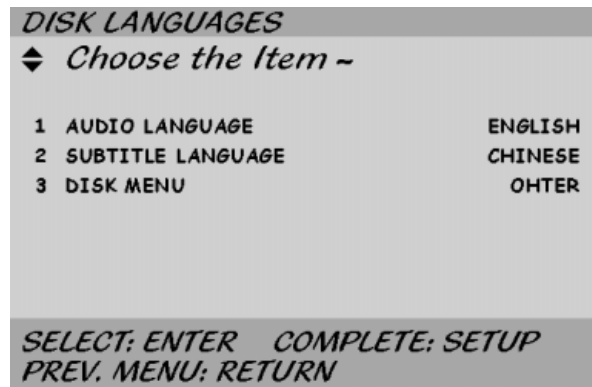
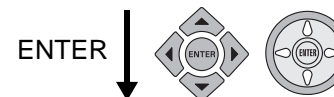
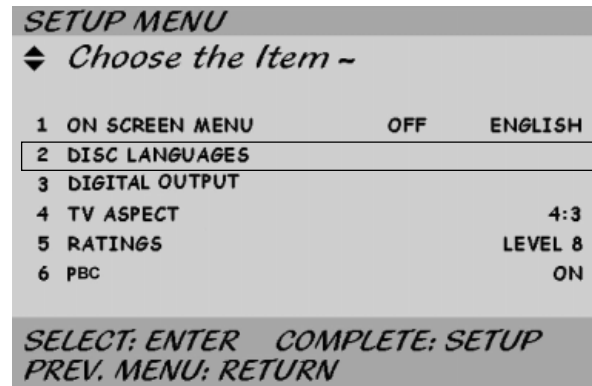

DVD

2 SUBTITLE LANGUAGE:

Scroll up or down to the Subtitle Language selection, then press **ENTER**. Selecting Français, English, or Auto will place subtitles in that language when playing a disc with that subtitled language. You can also enter a language code to make that language the subtitle language default choice. Once set, please press **RETURN** to select and return to the immediately preceding menu level. Press **SETUP** to exit from the setup menu altogether.



If your selected subtitle language is not available for the disc currently played, the player will automatically provide audio in the disc's default language.

ALL

3 DISK MENU:

Scroll up or down to the Disk Menu selection, then press **ENTER**. Selecting Français, English or Other will make DVD generated selections display in your language of choice. You may select Chinese, English, or another (by language code). Once set, please press **RETURN** to select and return to the immediately preceding menu level. Press **SETUP** to exit from the setup menu altogether.



If your selected disc menu language is not available for the disc currently played, the player will display automatically in the disc's default language.

Digital Output

The third of the six sections in the setup menu is entitled **DIGITAL OUTPUT**. Use the up or down cursor to scroll to this section and press **ENTER** to enter this screen.

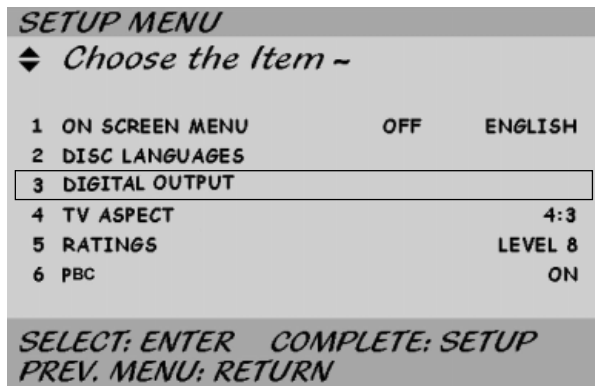

DIGITAL OUTPUT: [BITSTREAM / 2CH, 48KHz, 16BIT PCM]

Scroll up or down to the Disk Menu selection, then press **ENTER** to choose the digital output from the player. If you have an external Dolby AC-3 digital decoder, you can select **BITSTREAM**. This option supports 5.1 channel surround sound effects. If the **2CH, 48KHz, 16BIT PCM** option is selected, the player will just simply output digital signal. Once set, please press **RETURN** to select and return to the immediately preceding menu level. Press **SETUP** to extricate yourself from the setup menu altogether.



[BLANK]

TV Aspect

The fourth of the six sections in the setup menu is entitled **TV ASPECT**. Within this menu you have the option to select a 4:3 traditional screen format or 16:9 wide-screen format. The player uses 16:9 as default.

Use the up or down cursor to scroll to this section and press **ENTER** to enter this setup screen.

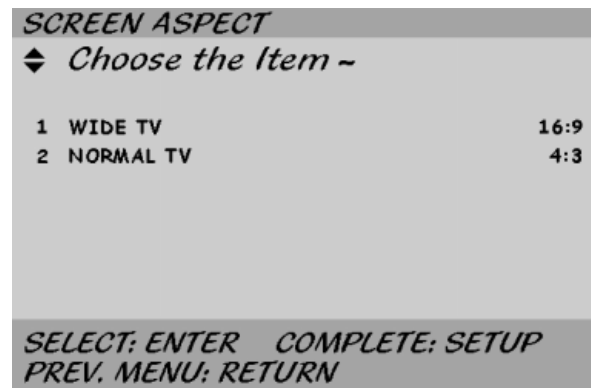
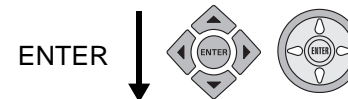
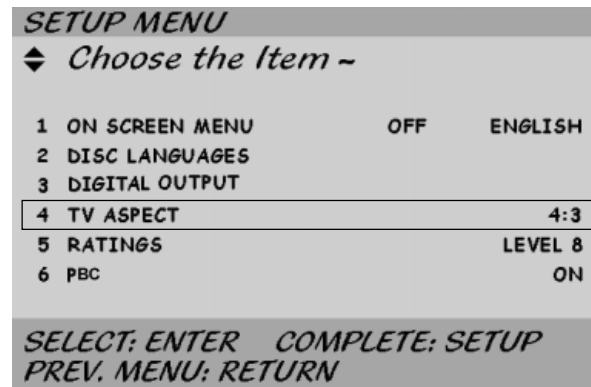

1 (WIDE TV - 16:9)

Scroll up or down to the Disk Menu selection, then press **ENTER** to choose the display screen format. The **WIDE TV 16:9** selection delivers a screen picture of a ratio 16 units wide and 9 units high. If you output to a television with a wide-screen format display, you should choose the 16:9 option. Once set, please press **RETURN** to select and return to the immediately preceding menu level. Press **SETUP** to exit from the setup menu altogether.

DVD**2 (NORMAL TV - 4:3): [LETTER BOX / PAN & SCAN]**

Scroll up or down to the Disk Menu selection, then press **ENTER** to choose the display screen format. Within the Normal TV selection you may choose **LETTER BOX** (full picture with black margins on top and bottom) or **PAN & SCAN** (picture cropped on left and right margins). If you output a 16:9 DVD program to a television with a traditional screen format display, you should choose one of the two Normal TV options. Once set, please press **RETURN** to select and return to the immediately preceding menu level. Press **SETUP** to exit from the setup menu altogether. Please see the box to the right for a graphic representation of picture display ratios.

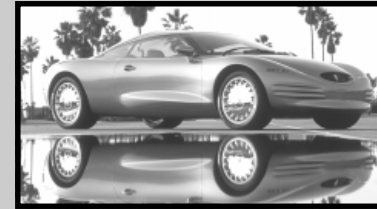
DVD

Viewing a 16:9 image on a 16:9 wide-screen format display.



Viewing a 16:9 image on a 4:3 traditional screen format display with the "LETTER BOX" option.



Viewing a 16:9 image on a 4:3 traditional screen format display with the "PAN & SCAN" option.

Ratings

The fifth of the six sections in the Setup Menu is entitled **RATINGS**. As some DVD program was not designed for all to view, a rating system was established to provide limited viewing standards.

A typical DVD rating system is incorporated with eight level of limitations, when a DVD is attempted to be played that is rated higher than the level set, the player will automatically halt play.

Use the up or down cursor to scroll to this section and press **ENTER** to enter this setup screen. There are a total of 8 choices. The higher the number value selected, the looser the rating restriction placed on DVDs permitted for viewing. Similarly, the lower the number, the stricter the criteria for viewing.

! Under normal conditions a password must be entered to change the rating value. When you enter the Rating menu and/or when you choose to change the current rating value, the player will return a password request. Please refer to page 56 regarding how to set and change a password.

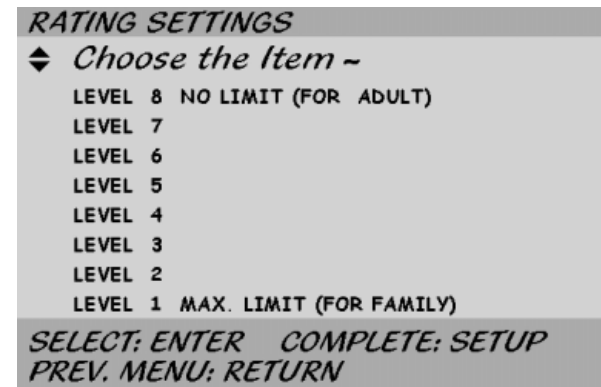
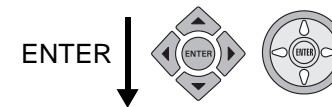
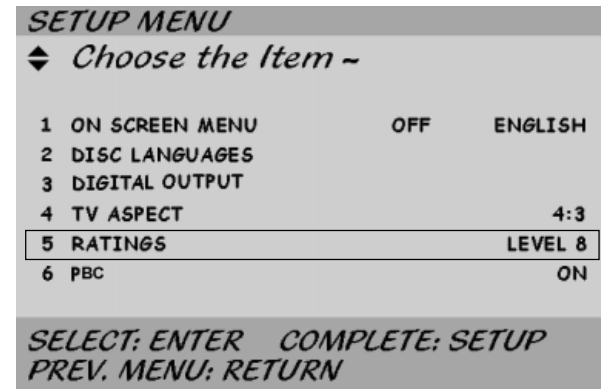

LEVEL 8 NO LIMIT (FOR ADULT)

Scroll up or down to this selection, then press **ENTER** to choose. In level 8, there is no any restrictions to the viewer and will permit viewing of DVDs of all ratings.

DVD

LEVEL 7-2

Selecting a value between 2 and 7 will permit the viewing of DVDs rated at or below the set value only.

DVD

LEVEL 1: Most Restrictive (suitable for viewing by all family members)

Selecting a value of 1 will only permit those DVDs rated as suitable for all ages to be played on your player.

DVD

! The rating of each DVD is encoded by the manufacturer and it is this code that is read by the player. Running System Setup to the player to set the default limitation level. When playing a DVD in which the level was set higher by the publisher than the default level you set to the player, the program will not be played.

Rating References

8	NC-17
7	NC-17
6	R
5	PG-13
4	PG-13
3	PG
2	G
1	G

VCD Playback Control

The last of the six sections in the Setup Menu is entitled **PBC** which stands for VCD Playback Control. This option could only be activated for VCD version 2.0 discs. Typically, VCD version 2.0 discs are formatted similarly to DVD discs when manufactured with a menu selection option. The standard format for VCD is to return to the main menu after each segment has finished playing. If you wish not to cut off at the end of each segment, you may turn the playback control **OFF**.

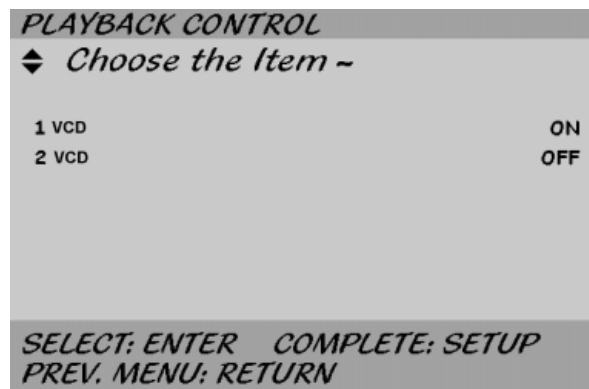
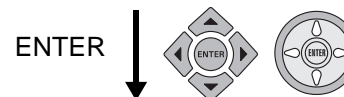
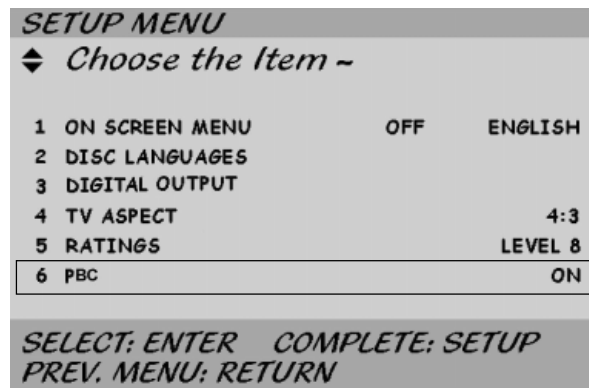

[B L A N K]



Changing Settings During Play (Part I - for DVD)

Different from system settings, you have the option of changing play / language settings for the current disc in play. Pressing the **ON SCREEN DISPLAY** button on the remote control will bring the title display menu up on screen. Using the directional keys on the remote will help you access a variety of playback control options.



1 Title Symbol

This field displays the current DVD title code. Press the ◀ or ▶ keys on the player or remote control to go to this field, then press ▲ or ▼ to make a selection. Press **ENTER** to confirm and go to another selection topic.

2 Chapter Symbol

This field displays the current DVD chapter code. Press the ◀ or ▶ keys on the player or remote control to go to this field, then press ▲ or ▼ to make a selection. Press **ENTER** to confirm and go to another selection topic.

3 Play Time Symbol

This field displays the play time of the current DVD program in the format [hours, minutes, seconds]. Press the ◀ or ▶ keys on the player or remote control to go to this field, then press ▲, ▼, or numbers on the remote keypad to make a selection. Press **ENTER** to confirm and go to another selection topic.

4 AUDIO Symbol

This field displays the current broadcast language code. Press the ◀ or ▶ keys on the player or remote control to go to this field, then press ▲ or ▼ to make a selection. Press **ENTER** to confirm and go to another selection topic. Note that if a particular DVD does not support the selected language, this function will not work.

8 Changing Setting During Play - DVD (Contd.)

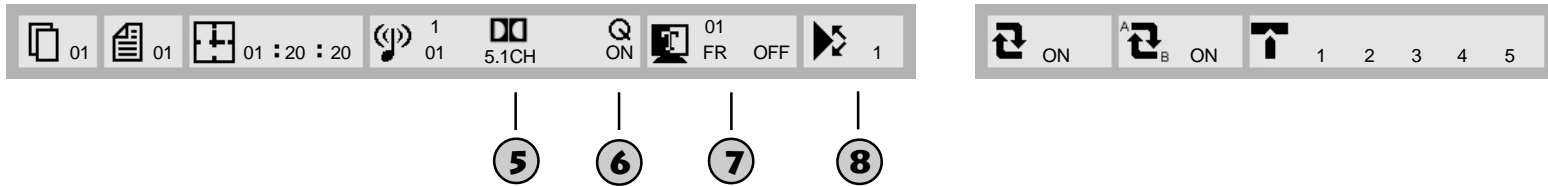

5 Sound Channel Symbol

This field displays the sound channel selection for the current DVD play. This field cannot be altered while DVD is playing.

6 Q SURROUND Symbol

This field displays whether Q Surround is currently enabled. Press the ◀ or ▶ keys on the player or remote control to go to this field, then press ▲ or ▼ to make a selection. Pressing the **Q SURROUND** key on your remote will achieve the same effect. Press **ENTER** to confirm and go to another selection topic.

7 SUBTITLE Symbol

This field displays the current subtitle language preference. Press the ◀ or ▶ keys on the player or remote control to go to this field, then press ▲ or ▼ to make a new selection for this play. Press **ENTER** to confirm and go to another selection topic. You may also elect to close out the subtitle.

8 ANGLE Symbol

This field displays the current angle selected. Press the ◀ or ▶ keys on the player or remote control to go to this field, then press ▲ or ▼ to make a selection. Press **ENTER** to confirm and go to another selection topic. This function is invalid for DVDs that do not offer the option of multiple angle shots.

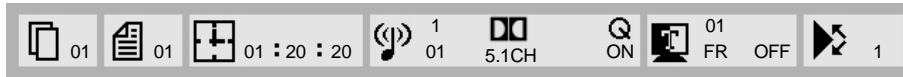

9

10

11

9 REPEAT Symbol

This field displays the current repeat preference for this DVD play. Press the ▲ or ▼ keys on the player or remote control to select Chapter Repeat (C); (OFF); Title (or Track) Repeat (T); Disc Repeat (D); or Cancel.

10 A-B REPEAT Symbol

Pressing this key on the remote at two separate times (points) during disc play will cause the disc to repeat play between the two selected points. Pressing the **A-B** key again will automatically reset the start and end points.

11 BOOKMARK Symbol

This key sets the memory function. Use the ◀ or ▶ keys to move the cursor over one of any of the five positions to the right of the symbol. Press **ENTER** to confirm. The current play time will be recorded, up to a maximum of five positions.

If you wish to skip forward to any one of the selected positions, again use the ◀ or ▶ to make your choice, then press **PLAY** or ▼ to begin playing the selection. Position memory will be erased automatically when a disc is removed from the player.

Changing Settings While in Play (Part II: for VCD)

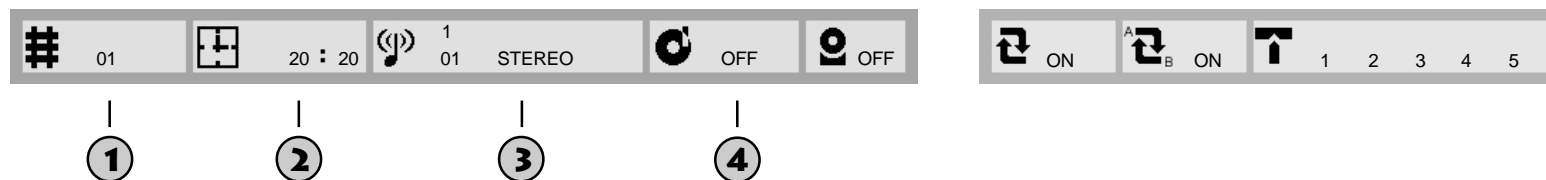

1 TRACK Symbol

This field displays the current play track. Press the ▲ or ▼ keys on the player or remote control to go to this field, then press ◀ or ▶ to make a selection. Press **ENTER** to confirm and go to another selection topic.

2 Play Time Symbol

This field displays the play time of the current VCD program in the format [hours, minutes, seconds].

3 AUDIO Symbol

Pressing the Audio key then cursoring ▲ or ▼ allows you to switch between two track output (stereo), left speaker only, and right speaker only sound.

4 PROGRAM Symbol

This field displays whether a programmed play has been set. Press the ▲ or ▼ keys to enable or disable programmed play. Please refer to page 66 for further information regarding programming.

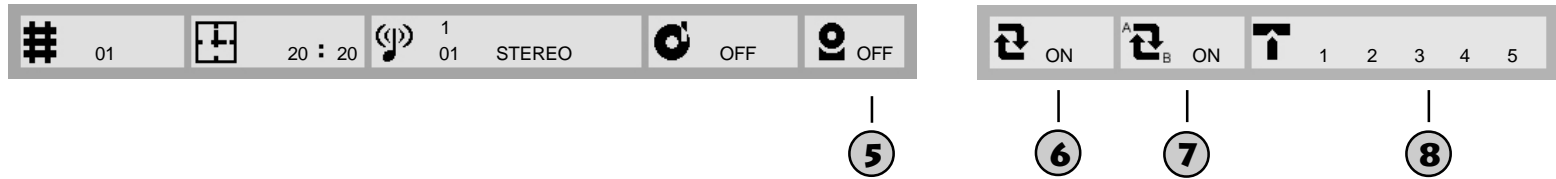

5 VCD Program Broadcast Control Symbol

This field displays whether the VCD PBC is enabled. Press the ▲ or ▼ keys to enable or disable this function. Please refer to page 56 for further information regarding Program Broadcast Control.

6 REPEAT Symbol

This field displays the current repeat preference for this VCD play. Press the ▲ or ▼ keys on the player or remote control to select between current track or full disc repeat.

7 A-B REPEAT Symbol

Pressing this key on the remote at two separate times (points) during disc play will cause the disc to repeat play between the two selected points. Pressing the ▲ or ▼ keys will allow you to close or edit this function.

8 BOOKMARK Symbol

This key enables the positional memory function. Please refer to page 61 for details regarding this function.

Changing Settings while in Play (Part III: for CD):

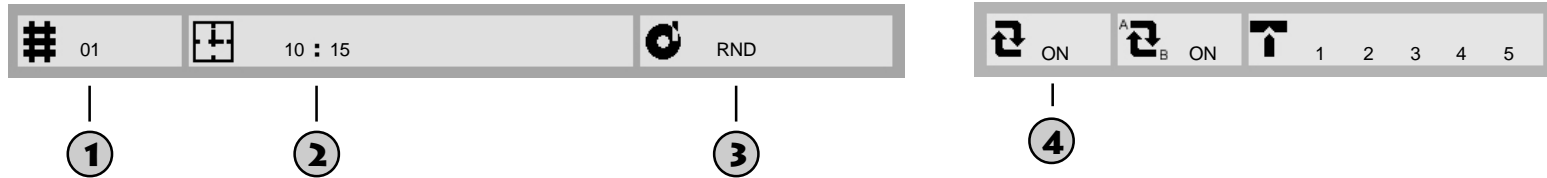

1 TRACK Symbol

This field displays the current play track. Press the ▲ or ▼ keys to skip to a desired track, then press **ENTER**.

2 Play Time Symbol

This field displays the play time of the current CD program in the format [minutes, seconds]. This field can not be altered.

3 PROGRAM Symbol

This field displays whether a programmed play has been set. Press the ▲ or ▼ keys to enable or disable programmed play. Please refer to page 66 for further information regarding programming.

4 REPEAT Symbol

This field displays the current repeat preference for this CD play. Press the ▲ or ▼ keys on the player or remote control to select between current chapter (song) or full disc repeat.

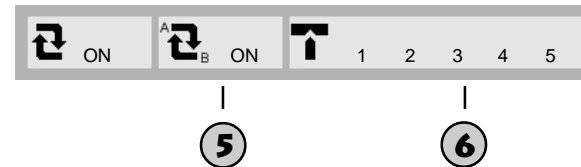

5

A-B REPEAT Symbol

Pressing this key on the remote at two separate times (points) during disc play will cause the disc to repeat play between the two selected points. Pressing the ▲ or ▼ keys will allow you to close or edit this function.

6

MARK Symbol

This key enables the positional memory function. Please refer to page 61 for details regarding this function.

9 Programmed Play

9

Programmed Play

The player permits programmed play for music CDs and VCDs. You have the option of programming up to 30 different song tracks to be played in the order you preference.

1. Place the CD or VCD into the player. While in play, or after pressing **STOP**, press the **ON SCREEN DISPLAY** key located on the remote control. The following screen should be displayed:



2. Press the ◀ or ▶ keys to place the cursor over the  field.
3. Under this field, press the ▲ or ▼ keys to scroll through the options, OFF, RND, and PRG located in the bottom right hand corner of the screen. Stop the cursor over PRG.
4. Pressing the **ENTER** key will call up the following screen:

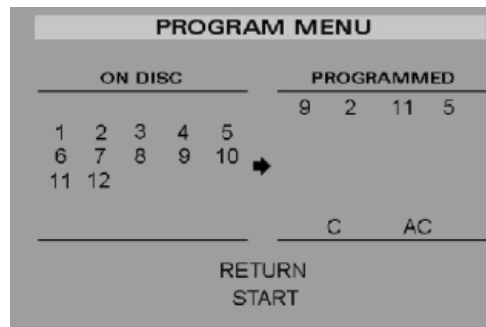

The left hand of the screen will display all available chapters (songs) on the current disc up to a maximum of 30. Scroll through these using the ◀ or ▶ keys and press the **ENTER** key once you have selected a desired song. The number of the selected song should then appear on the right side of the same screen. Repeat the process for a maximum of 30 choices.

5. Press the ▲ or ▼ keys until the cursor is over the word "START". Clicking on **ENTER** will begin playing songs in the order programmed.
6. If you wish to clear one selection from the program list, select that song and use the ▲ or ▼ keys on the right side of the screen to select "C" (clear) and press the **ENTER** key. This will clear the song from the play list and allow you to add a new one.
7. If you wish to clear the entire play list, follow the instructions above, but select "AC" and press the **ENTER** key.



In the event you wish to cancel programming actions during the programming process, use the ▲ or ▼ keys to select the "RETURN" field at the bottom of the screen. This will allow you to exit this screen and cancel unsaved changes.

When playing a programmed sequence, if the **STOP** key is pressed followed by **PLAY**, the player will start play from the position you just stopped and ignore the programmed sequence. However, the programmed play list is not erased, you can back to the programmed play by pressing the **PROGRAM** and **Play** keys, followed by the **START** key while the programming icon is shown on the screen.

If you wish to cancel a programmed play currently running, just press the **STOP** key then remove the disc, all program play data will automatically erased.

10

Connecting AV Peripherals

In keeping with its slim, light design, your player is not equipped with a monitor. To view or listen to a program, you will need to connect the included AV signal wires to the appropriate output plugs located along the left side of the player, then connect the other ends to input plugs on a television set or other AV device.

In the following sections are some recommended output configurations for your player.

Configuration I: AV Signal Output from AV Jack

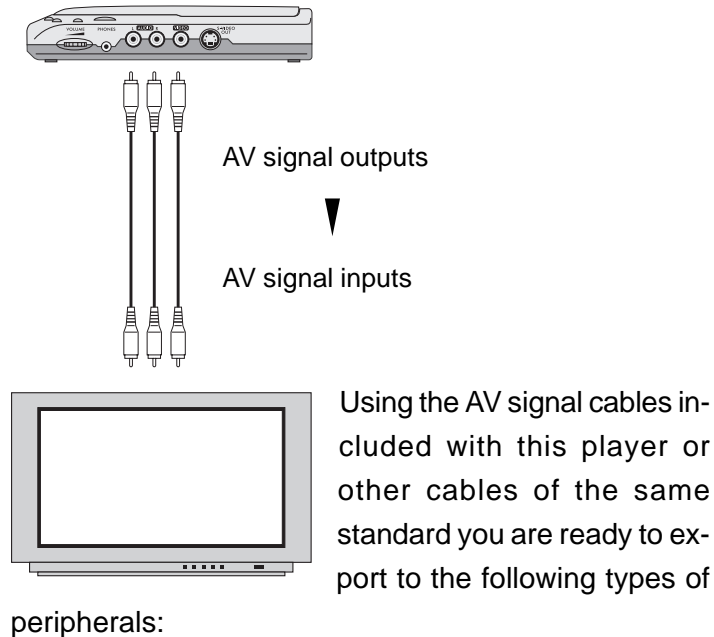

1. Television set with AV input jacks.
2. VCRs (Recording is not permitted)
3. 8mm and VHS-C video cameras (Recording is not permitted)
4. Overhead projectors

! Please note that AV signal cables are bundled in sets of three different colors. The white cable is intended to carry left speaker audio, the red cable right speaker audio, and the yellow cable image signal data. The three wires are not structurally different, but the colors are intended to aid in correct installation. Please make sure that each output is plugged into the correct peripheral input (e.g., yellow output plugs into yellow input, etc.). Also, most modern electronic equipment must be manually switched before input signals can be processed and displayed. Please refer to the relevant owners' manual to confirm how this switch should be accomplished.

NOTE

When the DVD player audio/video output is plugged into the A/V input jacks of a Video Cassette Recorder (VCR) using the audio/video cables, (red, white and yellow RCA jacks) poor picture quality may result (i.e. screen on TV getting brighter and dimmer) due to Macrovision copy guard protection contained on some DVD discs.

Configuration II: AV Signal Output from S-Video Port

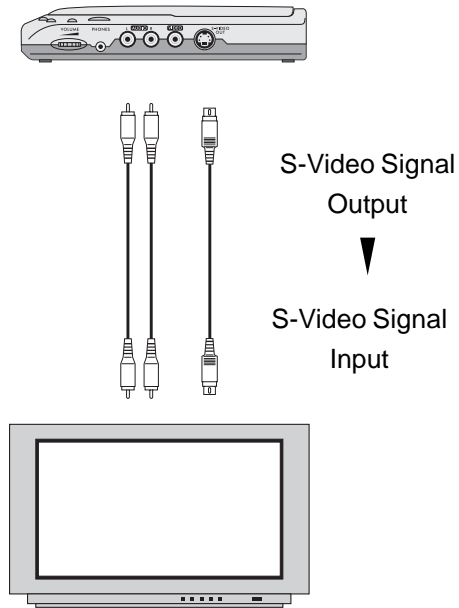

Certain AV equipment (e.g., high-end televisions and VCRs) include an S-Video input port. In this situation, you may use the included, or purchased, 4-pin S-Video signal cable in place of the yellow video cable. Using the S-Video cable should provide superior picture quality.

- ❗ The S-Video cable can be used instead of the yellow cable to output video data. However, while the S-Video is in use, the yellow cable will still output video data providing for dual outputs, if desired.
- ❗ The player must be using AC power (power cord), rather than DC power (batteries), to use the output S-Video feed.

Configuration III: Audio Signal Output from AV Jack

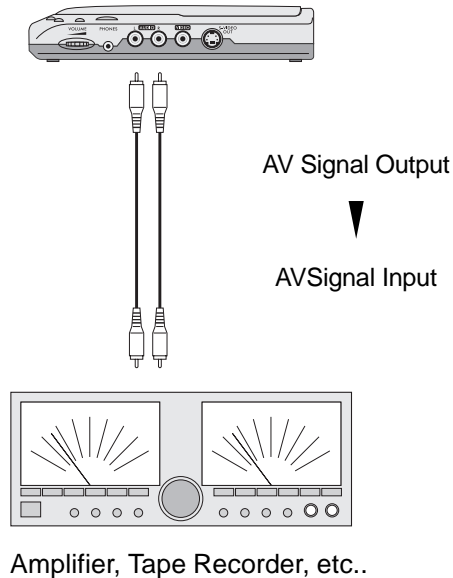

Using only the red and white AV signal cables, the DVD player can provide output signals, for recording or through play these dual track high-quality audio signals can interface to the following peripherals:

1. Amplifiers
2. Two-track and reel-to-reel tape recorders
3. Digital magnetic tape recorders (DATs)
4. Mini Disc player/recorders

The external audio equipment can be used to record or play the music from this player.



Audio output is delivered at stable amplitude and cannot be increased or decreased using the player volume control. Use the input level control on the equipment receiving the signal input to control sound volume. Most input jacks are of the 3.5 or 5 mm specification. When your peripheral is of the latter type, you should purchase an RCA-type adapter.

Configuration IV: Digital Audio Signal Output

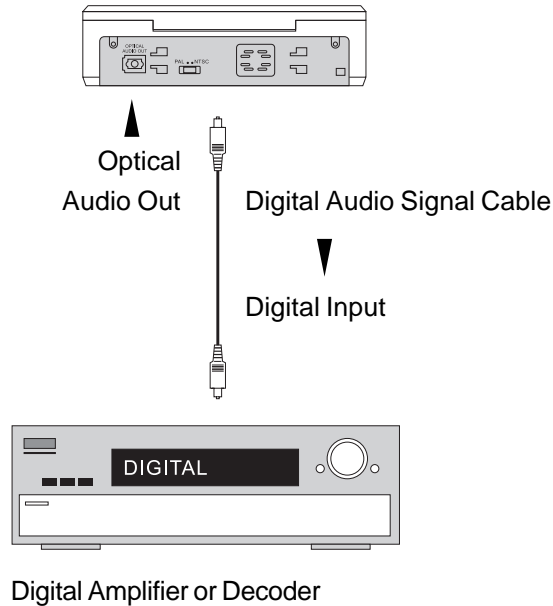

The audio portion of program discs can be output through the player's digital signal output port using the digital signal cable which is come with your player.

By digital audio signal transmission, you can obtain highest fidelity of music, please check whether your amplifier, digital signal decoder or other equipments you intend to connect has digital audio signal input port in order to use this feature.

Through digital audio transmission, your digital amplifier or decoder can accept and broadcast (1) Dolby AC-3 surround sound or (2) DTS (Digital Theater System) sound scheme encoded in the disc.

[BLANK]



Setting the Password and Rating

Most DVDs are rated by an 8-point grading level. The player will not permit a disc to be played if the disc is rated at a number higher than that set. A password must be entered in order to change the rating level currently set. Once the correct password has been entered you can change the rating level or disable this function.

Password protection is not set into the machine by the manufacturer. You are recommended to set the password soon after you purchase your player for convenience of use later. Remember that only by using a password can the view rating level be changed. Instruction on setting the password follows:

1. Turn player power on. If a disc is already installed in the player, it will automatically begin play. Please press the **STOP** (■) button.
2. Once the disc has stopped, press the **SETUP** button on the player or remote control. The menu screen should appear.

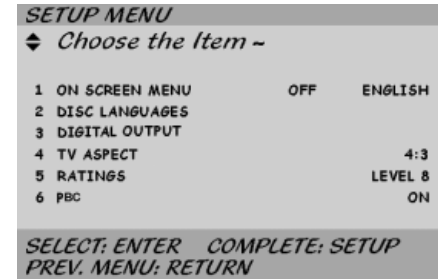

3. Press the ▲ or ▼ keys to move the cursor over the **RATINGS** field.
4. The cursor will initially be on Rating 8 (i.e., no viewing restriction). On rating 8 all DVDs can be viewed on the player, including those that may not be suitable for children and minors.

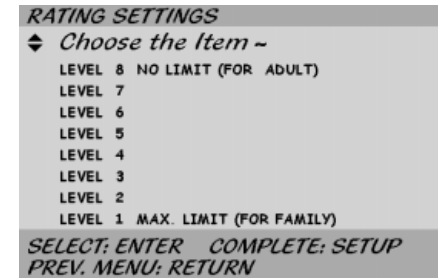

5. Press **ENTER** once more to switch to the password screen.

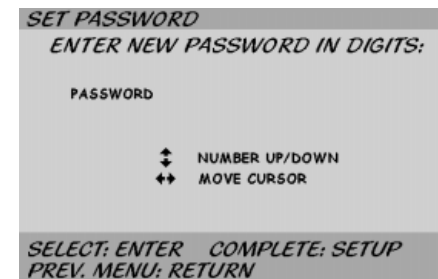

11 Setting the Password and Rating

6. Enter numbers directly on the remote keypad or move the ▲ or ▼ keys to select password numbers. Once entered, please do not forget this password.
7. Press **ENTER** to record your password into memory.

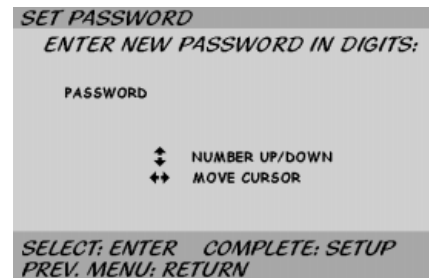

8. Press **ENTER** once again to return to the system select menu. Please note that, at this time, the view rating level is still at number 8.
9. Press **ENTER** to re-enter the rating level screen.
10. Use the ▲ or ▼ keys to select your preferred rating level.
11. Press **ENTER** to confirm. At this point a password dialog box will appear. Please enter your password.

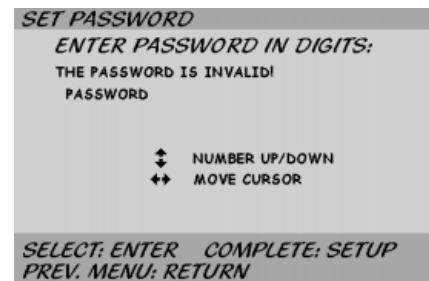

12. If the password is incorrect, the screen will return a password error message. In the Password Set screen are three fields, namely “REMOVE”, “CHANGE PASSWORD”, and “CHANGE RATING LEVEL”.

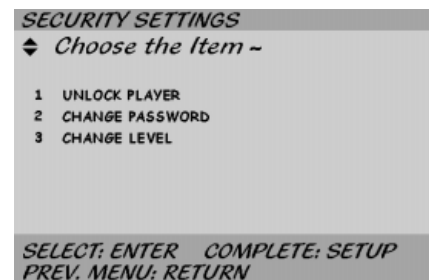

A. To enter the “REMOVE” field, press **ENTER** with the cursor over this field. The system will remove the password from its database and return a message that the player will no longer check for DVD rating levels. To re-instate the password function, please return to step 2 of this sequence.

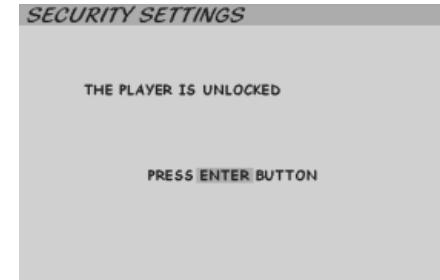

B. To enter the “CHANGE PASSWORD” field, press **ENTER** with the cursor over this field. The system will clear the present password from the memory and open a dialog box requesting a new password be entered.

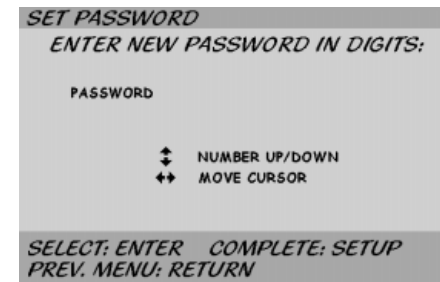

C. To enter the “CHANGE RATING LEVEL” menu, press **ENTER** over this field. Once in the menu, you can select a new rating level. Press **ENTER** again to confirm your choice.

After returning to the main selection menu, you may notice that the player rating level has already been updated. To change the rating level again, please return to step 10 of this procedure.

12

Rechargeable Battery Installation and Use

The player could utilize a set of long-life NiMH batteries for portable power supply. The NiMH battery pack is specially designed for your player, please consult your dealer for purchasing the battery pack. NiMH batteries feature high storage capacity and low level of degradation. The latter means the NiMH batteries doesn't have "Memory Effect" and thus can be recharged safely regardless of whether the battery is fully or only partially spent.

Please fully charge the battery prior to first use.

NOTE

When the DVD player is used with the battery as a power source, ensure that the battery has been charged for at

least eight hours prior to connecting it to the DVD player. In certain situations connecting a low charged battery to the DVD can result in software lock up.

If you plan to not use the battery for an extended period of time (say, one week or longer), we recommend that you first fully charge the battery and store it away properly. For longer periods of storage, please recharge the battery at least once every two months to maintain the battery in its best condition.

Please under no circumstances short out the battery, store the battery in a metal container, or leave the battery in a humid or damp environment. Ideally, store the battery in an airtight container with desiccant or other dehumidifying agent.

The NiMH battery may be recharged approximately 300 times. Each full recharge takes up to three-hours and one full charge can provide power the player for around 3 hours.

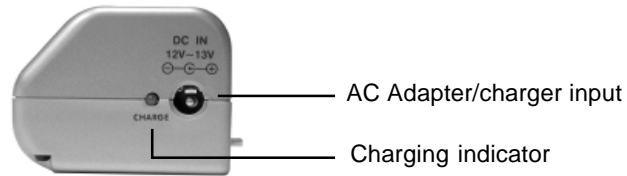

During recharge, the light next to the DC power input will light up red.

Once fully recharged, the light will turn green. At this point you may remove the wall plug and cease charging. During recharge, the batteries will become warm.

You can use the battery pack as the power source of the player while the battery is being charged. In this special situation, the charging time will be increased and please keep the set under room temperature under 77 °F.

Precautions related to Battery Recharge:

1. Once the battery has been fully spent, please immediately recharge the battery (regardless of whether you plan to use battery power again soon) in order to maximize battery life.
2. To charge the battery, please connect the power jack directly into the battery casing. Initially, a red light should light up. Once fully charged, this light will turn green and charging operations may cease (see the above picture).
3. An alternate way to charge your battery is to install the battery in your player and plug the player into a wall outlet. This way you will be able to recharge the battery while enjoying the player.

Please note that when the AC power supply jack is plugged directly into the player and not the battery pack, the battery pack is not being recharged.

Using and Maintaining your Rechargeable Batteries

1. Please make sure you always use only the AC transformer included with the player to recharge your batteries.
2. Recharge effectiveness will degrade when environmental temperatures drop below 50°F (10°C) or exceed 95°F (35°C).
3. Please remove battery from the player and store properly if the player is not to be used for an extended period of time. For periods of two months or more, please recharge the battery at least once every two months to avoid irreparable damage to the battery. If the battery left attached to the player for an extended period, please recharge the battery at least once every two weeks.
4. Avoid unnecessarily recharging fully charged batteries.

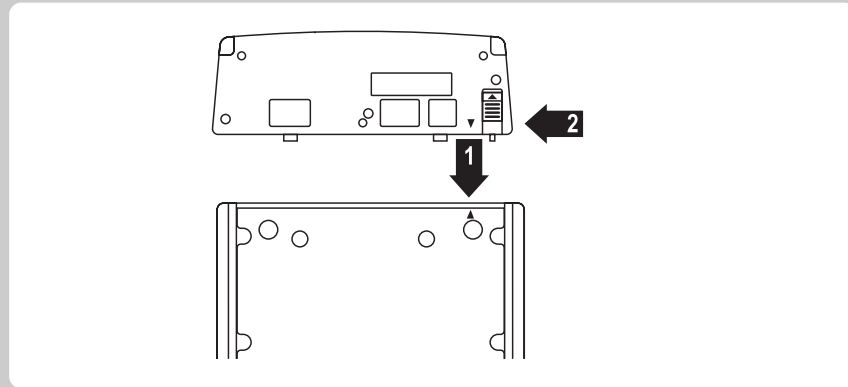

Installing the Battery Pack:

1. First, make sure the player is in “Stop” mode and that the AC power supply has been disconnected.
2. Close the player cover and flip the player over on its back side.
3. Align the battery pack with the player module’s rear edge. Please pay attention to the positioning arrows printed on both the battery pack and player.
4. Click the battery pack into position on the player module. Move the battery pack in the direction indicated by arrow (2) in the picture below. The pack is in the correct position when you hear a click sound.

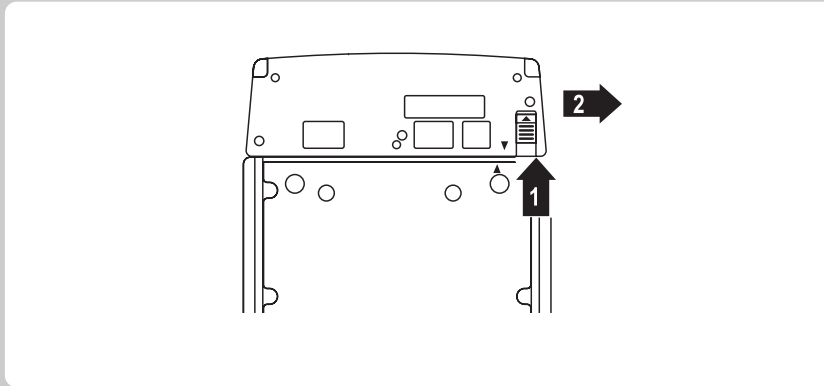

Removing the Battery Pack:

1. First, make sure the player is in “Stop” mode.
2. Flip the player over on its back side and press the set button in the direction indicated by arrow (1).
3. With the set button disabled, slide the battery pack out in the direction indicated by arrow (2).

13

User Precautions and Simple Maintenance

Your DVD player is an extremely precise AV broadcast system. Abiding by the following suggestions will help maintain your player in top working order and avoid safety problems.

! Storage

Please do not store your player in any of the following conditions (1) direct sunlight; (2) high temperature environment; (3) near any heat source. Similarly, please keep the player out of reach of small children.

! Vibration

The player compensates for slight jolts and vibrations during play. However, please do not expose the player to significant vibration during play. During play, the player's base will become warm and is nothing to be concerned about. However, please avoid using the player on a warm or hot surface (e.g., working amplifier, electric blanket, etc.).

! Condensation

Moving your player from a cold environment to a warm one will often result in moisture condensation. Under such conditions, wait at least one hour before using your player.

! Metal Contact Point

Keep the metal contact points on your player clear of dust, grime, and other contaminants. Remove contaminants with a clean cotton swab dabbed with a good electronics-safe solvent. Make sure that cotton bits do not become entangled or stuck on contact points.

! Scratches

Avoid storing your player alongside hard or sharp objects to avoid damaging player surfaces. If the player surface is soiled, use a soft rag and a small amount of mild solvent to wipe it clean. Do not use alcohol, because it will damage surface coatings.

! Signal and Power Cables

Do not place unnecessary strain or tension on signal or power cables. When unplugging cables, hold firmly by the base (and not the cable wire). When storing, do not bend cables too tightly.

! Power Surge

During electrical storms, remove the AC transformer from your wall socket to avoid electrical spikes that could damage sensitive electronics. In exceptionally dry conditions, you should gently touch the player with your bare finger prior to use to dissipate any built-up static electricity.

! Dust

Avoid using your player in windy / dusty conditions such as on the beach or outdoors during inclement weather.

! Laser Head

The laser reader head is an exceptionally fragile component and all contact should be avoided. There should be no need to clean the head, even with a laser head cleaner. There is the additional danger that filaments separated from such laser head cleaners can damage the head afterwards during high speed play operation.

13 User Precautions and Simple Maintenance

Self Repair

Again, the player is an exceptionally delicate instrument and should not be repaired or have parts changed except by authorized service personnel.

Remote Control Batteries

The player remote control operates on 2 Triple-A (AAA) batteries. Power consumption is exceptionally low and general-purpose batteries can be expected to last at least 6 months. Remove the batteries if the remote is not used for an extended period of time to prevent leaking and damage to the remote's internal circuitry. When installing new batteries, please make sure to select high-quality, non-leaking batteries.

AC Power Adapter

Please only use the AC power adapter included with your player. Do not use power transformers obtained elsewhere.

Recharging Battery



Do not disassemble the battery pack. Do not dispose of in fire. Dispose of in a proper manner and recycle where possible. Do not expose batteries to high temperatures. Do not permit battery contacts to touch metal surfaces and short. Avoid contact with all metal objects. For other battery maintenance and usage suggestions, please refer to page 78.

14

Specifications

Playing Discs:	DVD / SVCD / VCD / CD-DA
Dimension Inches (mm):	6.5 (165) (W) x 7.1 (181) (D) x 1.5 (38.5) (H)
Weight:	Approx. 1 Kg, without battery pack
Video Terminal:	Composite output RCA x 1, S video output mini DIN
Audio Terminal	
Analog out:	Two channel down mix output, headphone jack (mini type)
Digital out:	DTS / AC-3 / PCM optical output
DAC:	Audio 24 bit / 96KHz, video 10 bits
Power:	Universal AC to DC switching power adapter. DC 12V/3.8A AC to DC power adapter, approx. three hours
Remote Control:	Wireless remote control unit
DVD Function:	Multi story, multi angle, index mark, multi aspect, multi aspect, parental lock, multi audio stream choice, multi subtitle, subtitle on/off, frame advance play by step, slow motion playback (1/2, 1/4, 1/8), fast forward / back ward play (2x, 4x, 8x), 2x smooth playback



AUDIOVOX
ELECTRONICS CORP.

12 MONTH LIMITED WARRANTY

Applies to Audiovox Video Products

AUDIOVOX CORPORATION (the Company) warrants to the original retail purchaser of this product that should this product or any part thereof, under normal use and conditions, be proven defective in material or workmanship within 12 months from the date of original purchase, such defect(s) will be repaired or replaced with reconditioned product (at the Company's option) without charge for parts and repair labor.

To obtain repair or replacement within the terms of this Warranty, the product is to be delivered with proof of warranty coverage (e.g. dated bill of sale), specification of defect(s), transportation prepaid, to the Company at the address shown below.

This Warranty does not extend to the elimination of externally generated static or noise, to correction of antenna problems, to costs incurred for installation, removal or reinstallation of the product, or to damage to tapes, discs, speakers, accessories, or electrical systems.

This Warranty does not apply to any product or part thereof which, in the opinion of the Company, has suffered or been damaged through alteration, improper installation, mishandling, misuse, neglect, accident, or by removal or defacement of the factory serial number/bar code label(s). THE EXTENT OF THE COMPANY'S LIABILITY UNDER THIS WARRANTY IS LIMITED TO THE REPAIR OR REPLACEMENT PROVIDED ABOVE AND, IN NO EVENT, SHALL THE COMPANY'S LIABILITY EXCEED THE PURCHASE PRICE PAID BY PURCHASER FOR THE PRODUCT.

This Warranty is in lieu of all other express warranties or liabilities. ANY IMPLIED WARRANTIES, INCLUDING ANY IMPLIED WARRANTY OF MERCHANTABILITY, SHALL BE LIMITED TO THE DURATION OF THIS WRITTEN WARRANTY. ANY ACTION FOR BREACH OF ANY WARRANTY HEREUNDER INCLUDING ANY IMPLIED WARRANTY OF MERCHANTABILITY MUST BE BROUGHT WITHIN A PERIOD OF 30 MONTHS FROM DATE OF ORIGINAL PURCHASE. IN NO CASE SHALL THE COMPANY BE LIABLE FOR ANY CONSEQUENTIAL OR INCIDENTAL DAMAGES FOR BREACH OF THIS OR ANY OTHER WARRANTY, EXPRESS OR IMPLIED, WHATSOEVER. No person or representative is authorized to assume for the Company any liability other than expressed herein in connection with the sale of this product.

Some states do not allow limitations on how long an implied warranty lasts or the exclusion or limitation of incidental or consequential damage so the above limitations or exclusions may not apply to you. This Warranty gives you specific legal rights and you may also have other rights which vary from state to state.

U.S.A. : AUDIOVOX CORPORATION, 150 MARCUS BLVD., HAUPPAUGE, NEW YORK 11788 | 1-800-645-4994

CANADA : CALL 1-800-645-4994 FOR LOCATION OF WARRANTY STATION SERVING YOUR AREA

128-5918

Free Manuals Download Website

<http://myh66.com>

<http://usermanuals.us>

<http://www.somanuals.com>

<http://www.4manuals.cc>

<http://www.manual-lib.com>

<http://www.404manual.com>

<http://www.luxmanual.com>

<http://aubethermostatmanual.com>

Golf course search by state

<http://golfingnear.com>

Email search by domain

<http://emailbydomain.com>

Auto manuals search

<http://auto.somanuals.com>

TV manuals search

<http://tv.somanuals.com>