

---

# D2017

PORTABLE 10.2" LCD MONITOR AND DVD PLAYER

---



An LCD panel and/or video monitor may be installed in a motor vehicle and visible to the driver if the LCD panel or video monitor is used for vehicle information, system control, rear or side observation or navigation. If the LCD panel or video monitor is used for television reception, video or DVD play, the LCD panel or video monitor must be installed so that these features will only function when the vehicle is in “park” or when the vehicle’s parking brake is applied.

An LCD panel or video monitor used for television reception, video or DVD play that operates when the vehicle is in gear or when the parking brake is not applied must be installed to the rear of the driver’s seat where it will not be visible, directly or indirectly, to the operator of the motor vehicle.

**Notice:**

This Product incorporates copyright protection technology that is protected by method claims of certain U.S. Patents and other intellectual property rights owned by Macrovision Corporation and other rights owners. Use of this copyright protection technology must be authorized by Macrovision Corporation, and is intended for home and other limited viewing uses only unless otherwise authorized by Macrovision Corporation. Reverse engineering or disassembly is prohibited.

## Content

A. Introduction .....	4
B. Cautions and Warnings .....	4
C. Contents .....	6
D. Powering and Installation .....	6
E. Controls, Indicators and Connectors .....	7
F. Loading and Playing a Disc .....	8
G. Basic Operation.....	9
H. Menu .....	10
I. Display.....	10
J. Playing Audio CDS.....	13
K. Playing MP3 Discs .....	14
L. Viewing JPEG file .....	16
M. Connecting to Other Electronic Equipment.....	16
N. Setup .....	18
O. Specifications .....	21
P. Rechargeable Battery Installation and Use .....	21
Q. Troubleshooting .....	24

## **A. Introduction**

Thank you for choosing the D2017 portable DVD player. The main features include a 10.2" Wide Screen (16:9 Aspect Ratio) Liquid Crystal Display (LCD) monitor and a DVD player. The unit applies the latest state of the art electronics and is designed for use in vehicles, hotels, offices or your home. The unit is constructed to provide years of reliable, trouble-free service, and is compact so that you can take it with you anywhere and is designed for quick and easy installation. Please read the entire instruction manual supplied with this product prior to using. The documentation will assist you in using the system properly to obtain the best equipment performance. Please save this manual for later use.

## **B. Cautions and Warnings**

### **1. Placement**

To prevent fire or electric shock, do not expose this appliance to rain or moisture. Keep the unit away from strong magnets, heat sources, direct sunlight, excessive dust. If the unit is brought directly from a cold to a warm location, moisture may condense inside the unit. When the unit is moved from a cold to a warm location, wait about one hour before operating the unit, or remove the disc and leave the unit turned on until the moisture evaporates.

### **2. Installation**

Ensure that the D2017 portable DVD player is used in accordance with the instructions and illustrations provided in this manual.

### **3. Objects and Liquids**

Do not push objects of any kind into the unit through openings; do not spill or spray liquid of any kind on or in the system (this may result in a fire or electric shock). Do not place anything heavy on the unit. To ensure proper ventilation and proper

operation, never cover or block the slots and openings with a cloth or other material. It is hazardous to replace the battery incorrectly. Replace the battery only with the same or equivalent type. In order to protect the environment, please dispose the battery properly. Do not use the unit in temperatures higher than 95 degrees Fahrenheit or 35 degrees Celsius.

#### **4. *Disassembly***

Do not attempt to disassemble the unit. There is a risk of electric shock and/or exposure to Laser Radiation. Contact qualified service personnel if your system needs repair.

#### **5. *Cleaning Unit***

When cleaning, make sure the system is unplugged from the power source. Do not use liquid cleaners or aerosol cleaners. Use a cloth lightly dampened with water for cleaning the exterior of the system only.

#### **6. *Discs***

Do not use irregularly shaped discs such as heart or star-shaped discs as they may cause the unit to malfunction. Do not stick paper, tape or glue on the disc. Do not expose the disc to direct sunlight or heat sources. Do not touch the surface of disc. Handle the disc by its edge. Clean the disc by wiping the disc from the center out with a cleaning cloth. Remove the disc from the unit and store it in its case after playing. Some playback operations of discs may be intentionally fixed by software producers. Since this unit plays discs according to the disc contents the software producers designed, some playback features may not be available. Also refer to the instructions supplied with the discs.

## 7.Regional Coding

Both the DVD player and DVD discs are coded by region. These regional codes must match in order for the disc to play. If the codes don't match, the disc won't play. This unit's code is region 1. DVDs discs with other regional codes cannot be played in this unit

## C. Contents

1. 1 x 10.2" LCD Monitor & DVD Player Combo
2. 1 x Remote Control with battery (CR2025)
3. 1 x Audio/Video Adapter Cable
4. 1 x AC to DC Adapter
5. 1 x DC Power Adapter
6. 1 x Instruction Manual
7. 1 x Rechargeable Battery

## D. Powering and Installation

### 1. Powering the system indoors (Refer to Figure 1)

Plug one end of the AC to DC adapter into the DC input jack on the left side of the main unit, then plug the other end into the 110~240V AC power receptacle.

### 2. Powering the system in a car

Plug one end of the DC Power adapter into the DC input jack on the unit, then plug the other end into the vehicle power outlet.

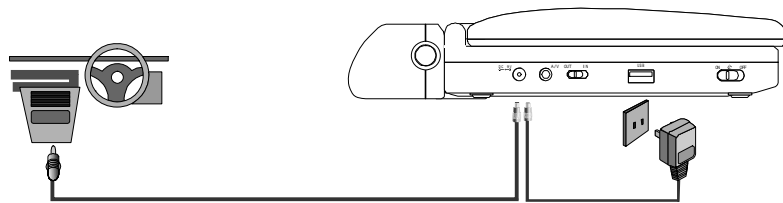
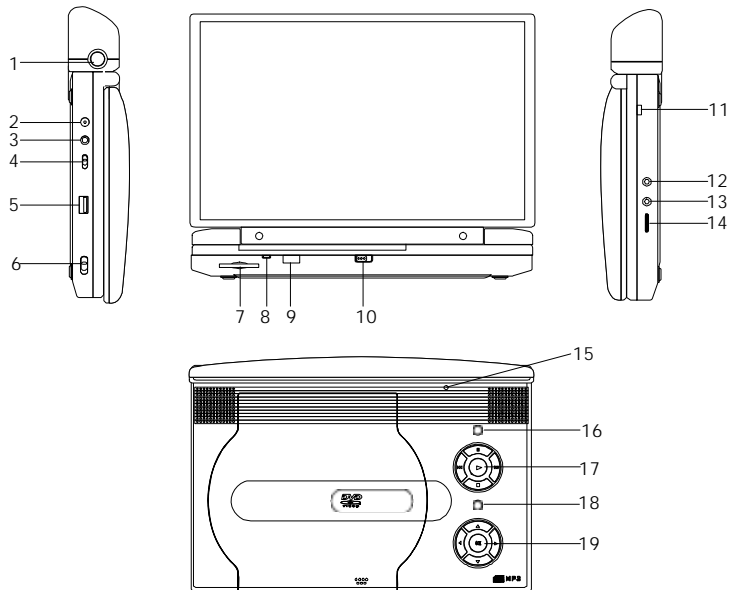

**Figure 1**

**Note:** Unplug the D2017 when not in use.

## E. Controls, Indicators and Connectors

### 1. Unit View (Refer to Figure 2)



**Figure 2**

- |                              |                                   |
|------------------------------|-----------------------------------|
| 1) Release Button of Battery | 10) Cover Open Switch             |
| 2) DC 9V Input Jack          | 11) Charge Indicator              |
| 3) AV Jack                   | 12) Headphone Jack 1*             |
| 4) AV In/Out SW              | 13) Headphone Jack 2              |
| 5) USB Port                  | 14) Volume Control                |
| 6) Power On/Ooff SW          | 15) LCD Panel shut off            |
| 7) SD/MMC/MS Slot            | 16) Wide Button                   |
| 8) Power LED                 | 17) Previous/Next/Pause/Stop/Play |
| 9) Remote Control Sensor     | 18) Menu Button                   |
|                              | 19) Up/Down/Left/Right/OK Button  |

\* Connecting to headphone jack number 1 will disable the internal speakers

## 2. Remote Control (Refer to Figure 3)

- 1) DVD/SD-USB Button
- 2) Display Button
- 3) Skip -Button
- 4) Menu Button
- 5) Left Button
- 6) Angle Button
- 7) Stop Button
- 8) Setup Button
- 9) Numeric Buttons
- 10) Brightness Decrease Button
- 11) Audio Button
- 12) Subtitle Button
- 13) Up Button
- 14) Skip+ Button
- 15) Enter Button
- 16) Right Button
- 17) Down Button
- 18) Play/Pause Button
- 19) Zoom Button
- 20) A-B Repeat Button
- 21) Brightness Increase Button
- 22) 1-All Repeat Button

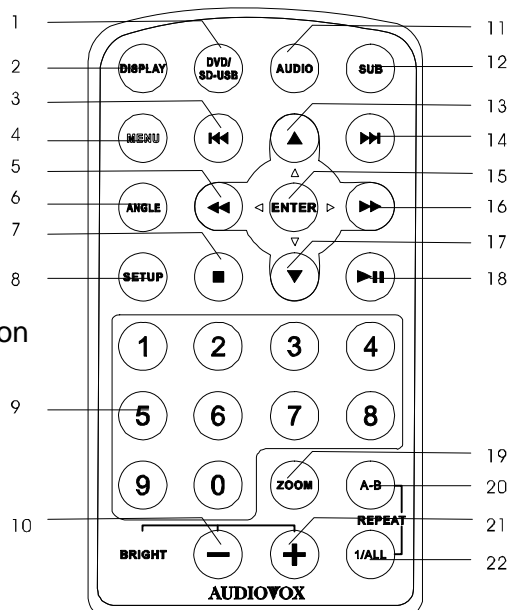

**Figure 3**

## F. Loading and Playing a Disc

- a. After connecting power to the unit, set the DVD player to ON using the power switch. The power indicator will light.
- b. Open the disc tray by sliding the OPEN switch in the direction of the arrow. Place a disc in the tray with label side facing up.
- c. Close the tray by pressing the area marked "PRESS". The unit will load the disc and start playing.
- d. Rotate VOLUME control to adjust the DVD player's volume and use the remote control BRIGHT button to adjust the LCD's brightness.
- e. To stop playing a disc, press STOP.



## **G. Basic Operation**

POWER	Turn the unit on/off
OPEN	Remove/load the disc
PLAY/PAUSE	Start Play/Execute item or setting Still Picture
STOP	(1 time) Stop and start at the present play-back point (2 times) Stop playback and start from beginning of disc
NEXT	Go to the next chapter, track or scene during play back
PREVIOUS	Go back to the previous chapter, track or scene during play back
FORWARD	Scan forward at 2, 4, 8, 16 or 32 times speed
REVERSE	Scan backward at 2, 4, 8, 16 or 32 times speed
LEFT/RIGHT/UP/DOWN	Used for Menu Navigation
ENTER	Execute item or confirm setting
NUMBERS	Select item or setting
MENU	Display the main menu of the disc
REPEAT	Repeat playing title, chapter, or track
A-B	Repeat a specific portion from point A to point B of the disc
DISPLAY	Display information (title, chapter, track, time, etc.).
SUBTITLE	Select the subtitle language or turn it on/off
AUDIO	Select the audio language
ZOOM	Enlarge an image to 2, 3, or 4 times the original size.
SETUP	Display the setup menu to select and set items and exit the setup menu.

## H. Menu

A DVD is divided into sections called titles and chapters. When you play a DVD's root menu of the disc will appear on the screen of your TV or Monitor. The contents of the menu vary from disc to disc. Press MENU during playback to display the menu. Some DVDs only allow you to select disc playback options using the DVD root menu.

## I. Display

### 1. PLAYING TIME AND REMAINING TIME

- a. During playback press the 'DISPLAY' button to display the current Title Number (1), the total Number of Titles (2), the current Chapter Number (3), the total Number of Chapters (4), and the elapsed playing time for the title (5).

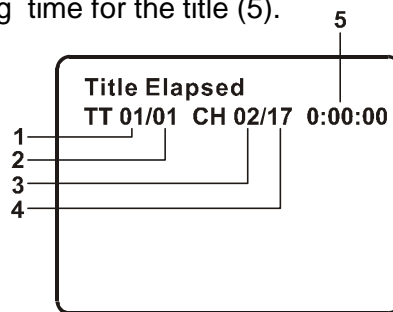

### Title, Chapter Number, and Time Screen Display

- b. Press 'DISPLAY' repeatedly to choose the options below in sequence.

Title Elapsed: The elapsed time of the title

Title Remain: The remaining time of the title

Chapter Elapsed: The elapsed time of the chapter

Chapter Remain: The remaining time of the chapter

Display Off: The DVD's time information is removed from the display.

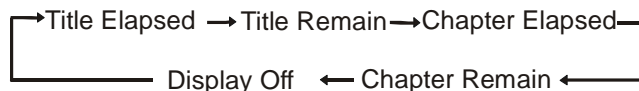

## 2. SUBTITLE

During disc playback press 'SUBTITLE' to select the subtitle language you desire\*, with the current Subtitle Language Number (1) and the total Number of Subtitle Languages (2) displayed. If there are multiple languages press 'SUBTITLE' again to select another subtitle language. To turn subtitles OFF, press the 'SUBTITLE' button until 'Subtitle Off' is displayed. The Subtitle display will disappear automatically if the 'SUBTITLE' button is not pressed again within 3 seconds.

\* Some DVDs only allow access to this function through the DVD menu

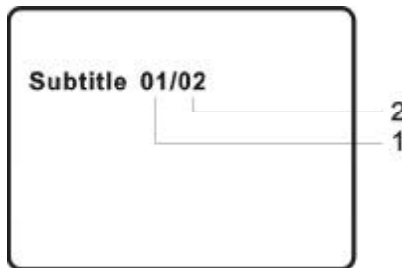

**Subtitle**

## 3. AUDIO

During playback press 'AUDIO' to select the audio language you desire\*, with the current Audio Channel Number (1) and the total number of Audio Channels (2) displayed. Press AUDIO again to select another audio language. The audio display will disappear automatically if the 'AUDIO' button is not pressed within for 3 seconds.

\* Some DVDs only allow access to this function through the DVD menu.

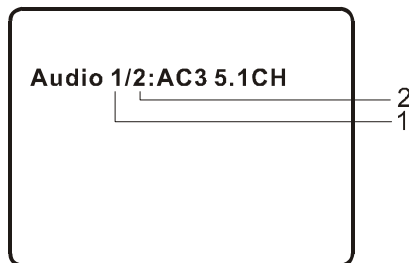

**Audio Language**

#### 4. ZOOM

During playback press 'ZOOM' multiple times to enlarge the picture by 2X, 3X or 4X.

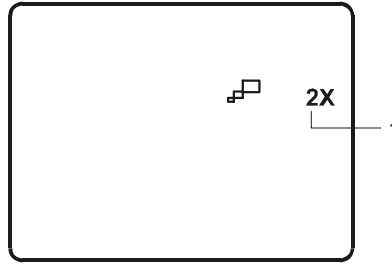

**Zoom**

#### 5. A-B REPEAT

- a. During playback press the 'A-B' button once to set the Starting Point A.
- b. Press 'A-B' a second time to set the Ending Point B. The player will repeatedly play the part between Point A and Point B.
- c. Press A-B a third time to cancel A-B repeat (REPEAT OFF) and resume normal playback.

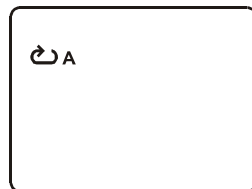

**A-B Repeat Starting Point**

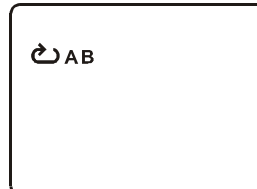

**A-B Repeat Ending Point**



**A-B Repeat Cancelled**

## 6. REPEAT

- a. During playback press 'REPEAT 1/ALL' repeatedly to cycle through the repeat modes.

Chapter: Repeat the current chapter  
Title: Repeat the current title  
All: Repeat all chapters and titles  
Repeat Off: Resume normal playback

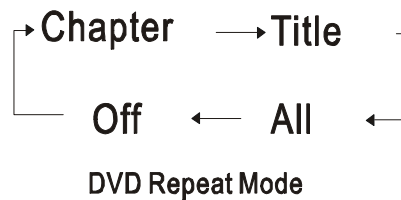

## J. Playing Audio CDS

When playing an audio CD press the DISPLAY button repeatedly on the remote to view time information. The options below appear on screen display in sequence to show you what information is available using this function.

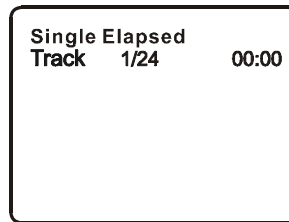

### Single Elapsed When Playing Audio CDs

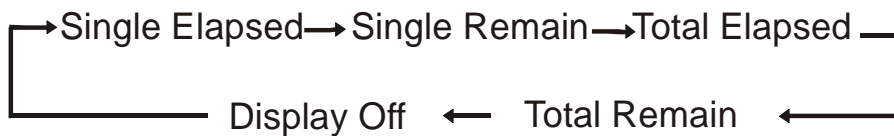

### CD Display Mode

Single Elapsed: The current track playing and the elapsed time of that track will be displayed on the screen.

Single Remain: The current track playing and the amount of time remaining.

- Total Elapsed: The current track playing and the total time that the CD has been playing.
- Total Remain: The current track playing and the amount of time remaining on the CD.
- Display Off: The CD time information is removed from the display.

### **USING THE 1/ALL REPEAT FEATURE**

The default mode for the 1/ALL REPEAT feature is OFF. Pressing 1/All REPEAT button consecutively changes the repeat options:

- *Track-* repeats the track that is playing.
- *All-* repeats the disc that is playing.
- *Repeat Off*

As you toggle through the options, the repeat option changes. The selected repeat option will play until turned off.

**NOTE:** The A-B Repeat feature functions in the same way for an audio CD as it does for a DVD disc.

### **K. Playing MP3 Discs**

MP3 is a format for storing digital audio. An audio CD-quality song is compressed into the MP3 format with very little loss of audio quality while taking up much less disc space. CD-R /RW discs that have been encoded in MP3 format are compatible with this system.

When an MP3 disc is inserted into the unit, the menu screen appears automatically. You can use the menu screen to select your desired folders and songs or the system plays the songs in the order they were burned onto the disc.

1. Press the ▲ or ▼ button to choose a folder from the folder list on the left side of the screen.
2. Press ENTER to select the highlighted folder. The songs available under the folder will be listed.
3. Use ▲ or ▼ button to choose a song from the list. Press ENTER to select and begin playback of the highlighted song.

4. Use the ►► ( NEXT ) button to move to the next song. Press the ◀◀ (PREVIOUS) button to move to the beginning of the previous song.

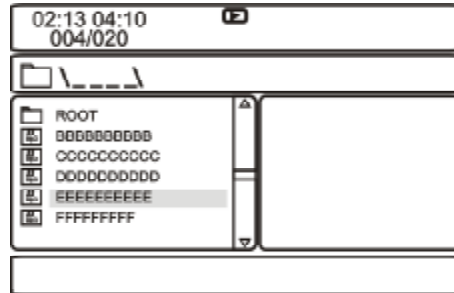

### USING THE 1/ALL REPEAT FEATURE

The default mode for the 1/ALL REPEAT feature is OFF. Pressing 1/ALL REPEAT consecutively changes the repeat options:

- Repeat One (repeat playback of a song)
- Repeat Folder (repeat playback of a specific folder)
- Repeat Off (normal playback)

As you toggle through the options, the repeat option changes. The selected repeat option will play until turned off.

**NOTE:** The A-B Repeat feature functions in the same way for an audio CD as it does for a DVD disc.

### NOTE:

- “” icon in front of a file name indicates that this is a folder, not an MP3 file.
- “MP3” icon in front of a file name indicates that this is a MP3 file.

**NOTE:** Due to the company’s policy of constant improvement and technical refinement, the company reserves the right to change or alter software.

## L. Viewing JPEG Files

- 1) Load the JPEG Disc into tray.
- 2) Select a JPEG file by pressing “UP/DOWN” button.
- 3) You can preview the JPEG file by pressing “PLAY” or “ENTER”.
- 4) Pressing the “Down” button will rotate the picture clockwise.
- 5) Pressing the “Up” button will access the main menu.

## M. Connecting to other Electronic Equipment

### 1. Connecting to a TV or another monitor ( Refer to Figure 4)

- a. Position the AV In/Out Switch to “Out” Position.
- b. Connect one end of the audio/video adapter cable’s black 1/8” plug into the unit’s AV jack. Using a standard A/V cable (not supplied), connect the other end to the AUDIO/VIDEO Input jacks on your TV or Monitor (white = left audio channel, red = right audio channel, yellow=video).

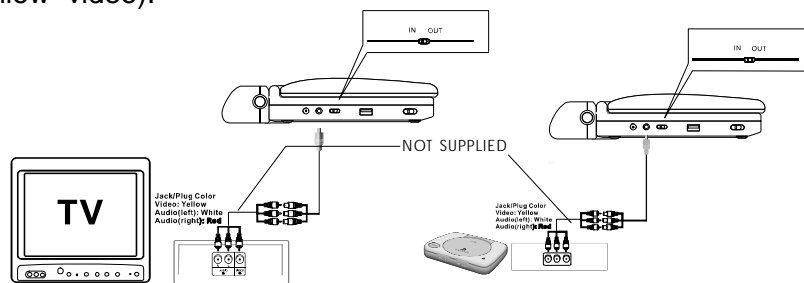

Figure 4

### 2. Connecting to a Game or Camcorder (Refer to Figure 4)

- a. Position the AV In/Out Switch to “In” Position.
- b. Connect one end of the audio/video cable’s black (1/8” plug into the unit’s AV jack using a standard A/V cable (not supplied), and connect the other end to the AUDIO/VIDEO output jacks on your Camcorder or game (white = left audio channel, red = right audio channel, yellow = video).

**Note:** Please do not connect an AV signal source to the AV jack when the unit is in “AV Out” Mode.



### 3. Headphones

Optional wired headphones may be used with the unit. Simply plug in the headset to either Headphone 1 jack or Headphone 2 jack on the right side of the DVD. ( Refer to Figure 5.)

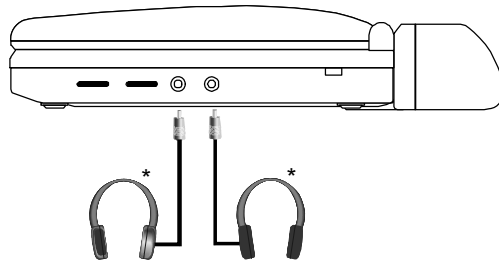

**Figure 5**

Plugging into Headphone jack 1 disables the internal speakers.

### 4. SD/MMC/MS Card and Thumb Drive/Digital Cameras

With no disc in the unit, insert either an SD card, Thumb Drive, or digital camera with JPEG or MP3 files into the appropriate input. Press the DVD/SD-USB button the appropriate position. Then you can:

- 1) Insert an SD Card into the SD Slot on the front of the unit.
- 2) Insert a Thumb Drive into the USB jack on the left side of the unit.
- 3) Connect the USB cable (not supplied) from a camera into the USB port on the left side of the unit.

## **N. Setup**

### **1. General Setup Page**

1) With no disc inside the player, press 'SETUP' to display the Main screen of the Setup Menu on the screen and "General Setup Page" appears. At the same time, " " is highlighted. Press 'SETUP' again to exit the Setup Menu.

2) Press the ▲ or ▼ buttons to select the other menus in general setup page.

3) With "TV Display" highlighted press the ENTER button.

4) Press ►► to enter the sub menu.

5) Press the ▲ or ▼ button to select the desired option in the sub menu and press the ENTER to confirm your selection.

6) Repeat steps 3-5 for other menus.

Note: Press ◀◀ to return the previous menu.

#### **a) TV Display**

\* Normal/PS: When the player outputs signal to a normal TV, a normal picture is shown on the full screen.

\* Normal/LB: When the player outputs signal to a normal TV, a normal picture is shown on the screen with a black strip at both the top and bottom of the screen.

\* Wide: When the player outputs signal to a wide screen TV, a wide picture is shown on the full screen.

#### **b) Angle Mark**

\*On: Allows access to the angle feature if contained on the DVD.

\*Off: The unit will not display the angle mark feature.

**NOTE:** Not all discs contain above features. The above features are disc dependent.

#### **b) Screen Saver**

\*On: Enables screen saver

\*Off: Disables screen saver

**\*NOTE:** The DVD player will enter the Screen Saver mode after approximately three minutes if the same image remains on the screen.

### c) Last Memory

\*On: The unit will return to the last position on the disc.

\*Off: The unit will not return to the last position on the disc.

**Note:** The Last position memory function will only work when the disc tray is OPEN.

## 2.Video Quality Setup

1) In Setup menu, Press the ◀◀ or ▶▶ button to select "Video Quality Setup" and  is highlighted. Press ENTER to enter the video quality setup page.

2) Press the ▲ or ▼ button to select the other options in the video quality setup page.

3) "Brightness" is highlighted.

4) Press ▶▶ to enter the sub menu.

5) Press the ◀◀ or ▶▶ button repeatedly to adjust the selected option and press ENTER to confirm your selection.

6) Repeat steps 3-5 for other menus.

**NOTE:** Press ◀◀ to return the previous menu.

a) Brightness

b) Contrast

c) Saturation

d) Hue

## 3. Password

In the Setup menu, Press the ◀◀ or ▶▶ button to select "Password Setup Page" and  is highlighted. Press ENTER to enter the password page.

Press ENTER twice to enter the Password Change Page. Input the Old Password or the Default Password, the New Password, and Confirmed the New Password. Press ENTER to confirm the change.

**NOTE:** The default password is 3308.

## 4. Preference Page

1) In Setup menu, Press the ◀◀ or ▶▶ button to select "Preference Page" and  is highlighted. Press ENTER to enter the preference page.

2) Press the ▲ or ▼ button to select the other options in the preference page.

3) Press the ENTER button, "Audio" is highlighted.

- 4) Press ►► to enter the sub menu.
  - 5) Press the ▲ or ▼ button to select the desired option and press ENTER to confirm your selection.
  - 6) Repeat steps 3-5 for other menus.
- Note: Press ◀◀ to return the previous menu.

**a) Audio**

**b) Subtitle**

**c) Disc Menu**

**Note:** Language and subtitle selection is only available for discs that are recorded in the above listed languages. If the selected language is not available, the player will play and display on the screen the original recorded language contained in the disc.

**d) Parental**

Select 'Parental' using the ▲ and ▼ button, then press ►► to enter the submenu.

Select the parental level you desire using ▲ and ▼ the button for discs with lock-out function or multiple rating levels. These are listed from the lowest level (1KID SAFE) to the highest level (8 ADULT). Press ENTER and input 4 digit password, then press ENTER again to confirm the parental level setting.

**NOTE:** The level of 8 Adult is the factory default.

**e) Default**

Select 'Default' using the ▲ and ▼ button, then press ►► to enter the submenu. Press ENTER to make all of the settings return to the factory set mode.

**NOTE:** The parental setting and the password setting are not affected by the default reset function.

**NOTE:** The Default Password is **3308**. This password is always effective even after you have selected your own password and changed it. To avoid the possibility of others using the default password to set the parental level and change the password, you can record this default password in another area and delete it from this manual. Some discs can be limited depending on the age of users while some discs cannot.

## O. Specifications

Compatible DISC: DVD/CD/MP3  
Signal system: NTSC  
Panel size: 10.2 inch  
Frequency response: 20 Hz to 20 kHz  
Video output: 1 Vp-p/75 Ohm, unbalanced  
Audio output: 1.4V<sub>rms</sub>/10kOhm  
Audio S/N: Better than 60 dB  
Dynamic range : Better than 85 dB  
Laser: Semiconductor Laser, Wave Length: 650 nm/795 nm  
Power source: DC 9-12V  
Power consumption: 12 W  
Operating temperature: 41~95°F (5~35°C)  
Weight : 2.23 lbs (1.013 kg)  
Dimensions (W x D x H): 9.48 X 6.37 X1.57inches  
241 x 162 x 40mm  
Battery Type: Li-polymer

*Design and Specifications are subject to change for product improvement without notice*

## P. Rechargeable Battery Installation and Use

The player utilizes a set of long-life Li-polymer batteries for a provide portability. Li-polymer batteries feature high storage capacity and low level of degradation. This means the Li-polymer batteries do not have “Memory Effect” and thus can be recharged safely regardless of whether the battery is fully or only partially discharged. Please fully charge the battery prior to first use.

**NOTE:** When the DVD player is used with the battery as a power source, ensure that the battery has been charged for at least eight hours prior to connecting it to the DVD player.

If you plan not to use the battery for an extended period of time (one week or longer), we recommend that you first fully charge the battery and store it away properly. For longer periods of storage, please recharge the battery at least once every two months to maintain the

battery in optimum condition. Do not short the battery terminals, store the battery in a metal container, or leave the battery in a humid or damp environment. Ideally, store the battery in an airtight container with desiccant or other dehumidifying agent. Each full recharge takes approximately five-hours and one full charge can provide power to the player for about 2.5 hours.

During recharge, the red indicator will stay on. Once fully recharged, the Charge indicator LED on the right side of the unit will turn off. At this point you may remove the wall plug and stop charging.

**Precautions related to Battery Recharge:**

1. Once the battery is fully discharged, immediately recharge (regardless of whether you plan to use battery or not) in order to maximize battery life.
2. Recharge efficiency will degrade when environmental temperatures drop below 50°F (10°C) or exceed 95°F (35°C).
3. Please remove battery from the player and store it properly if the player is not to be used for long time. During this period, please recharge the battery at least once two months to avoid irreparable damage to the battery.

**Using your Rechargeable Batteries**

1. Please make sure you always use **only** the AC adapter included with the player to recharge your batteries. The DC Power Adapter cannot be used to recharge the batteries.
2. Set the Power switch to the OFF position.
3. Plug one end of the AC-to-DC adapter into the DC 9-12V jack on the left side of the unit.
4. The red charge indicator light on the right side of the unit will illuminate.
5. When charging is complete, the charge indicator light will turn off.

**Note:** when charging for the 1st time, allow the unit to charge for at least 8 hours. The unit can only be charged with the AC adapter; it will not charge with the vehicle power adapter.

### Installing the Battery Pack:

1. First, make sure the player is in “Power Off” mode and that the AC power supply has been disconnected.
2. Flip down the monitor.
3. Push the battery towards the rear of the player until it locks into position. The lock position is indicated by a click. The unit will fit snugly to the player.



**Figure 6. Installing the Battery**

### Removing the Battery Pack:

1. First, make sure the player is in “Power Off” mode.
2. Press the release button on the side of battery.
3. Pull the battery away from the rear of the unit.



**Figure 7. Removing the Battery**

## Q. Troubleshooting

PROBLEM	SOLUTION
No sound or distorted sound	<ul style="list-style-type: none"> <li>• Make sure your DVD is connected properly. Make sure all cables are securely inserted into the appropriate jacks.</li> </ul>
Can't advance through a movie	<ul style="list-style-type: none"> <li>• You can't advance through the opening credits and warning information that appears at the beginning of movies because the disc is programmed to prohibit that action.</li> </ul>
The icon (⊗) appears on screen	<p>The feature or action cannot be completed at this time because:</p> <ol style="list-style-type: none"> <li>1. The disc's software restricts it.</li> <li>2. The disc's software doesn't support the feature (e.g., angles)</li> <li>3. The feature is not available at the moment.</li> <li>4. You've requested a title or chapter number that is out of range.</li> </ol>
Picture is distorted	<ul style="list-style-type: none"> <li>• The disc might be damaged. Try another disc.</li> <li>• It is normal for some distortion to appear during forward or reverse scan.</li> </ul>
No forward or reverse scan	<ul style="list-style-type: none"> <li>• Some discs have sections that prohibit rapid scanning or title and chapter skip.</li> <li>• If you try to skip through the warning information and credits at the beginning of a movie, you won't be able to. This part of the movie is often programmed to prohibit skipping through it.</li> </ul>



## Troubleshooting (Cont)

PROBLEM	SOLUTION
IR sensor inoperative	<ul style="list-style-type: none"><li>• Verify that the batteries in the remote are fresh.</li><li>• Verify that the remote sensor eye is not obstructed.</li><li>• Verify that the infrared transmitter is affixed over the sensor eye of the component to be controlled.</li></ul>
Disc won't play	<ul style="list-style-type: none"><li>• Insert a disc with the label side facing up.</li><li>• Check the type of disc you put into disc tray. This DVD only plays digital video discs, audio CDs and MP3s.</li></ul>
Play starts, but then stops immediately	<ul style="list-style-type: none"><li>• Both the unit and the disc are coded by region. If the regional codes don't match, the disc can't be played. This DVD Player is Region Number 1.</li><li>• The disc is dirty. Clean it.</li><li>• Condensation has formed. Allow player to dry out.</li></ul>



## 90 DAY LIMITED WARRANTY

### Applies to Audiovox Video Products

AUDIOVOX ELECTRONICS CORP. (the Company) warrants to the original retail purchaser of this product that should this product or any part thereof, under normal use and conditions, be proven defective in material or workmanship within 90 days from the date of original purchase, such defect(s) will be repaired or replaced with reconditioned product (at the Company's option) without charge for parts and repair labor. A game controller, if supplied, is similarly warranted for ninety (90) days.

To obtain repair or replacement within the terms of this Warranty, the product is to be delivered with proof of warranty coverage (e.g. dated bill of sale), specification of defect(s), transportation prepaid, to the Company at the address shown below.

This Warranty does not extend to the elimination of externally generated static or noise, to correction of antenna problems, to costs incurred for installation, removal or reinstallation of the product, or to damage to digital memory/media devices, gaming devices, discs, speakers, accessories, or electrical systems.

This Warranty does not apply to any product or part thereof which, in the opinion of the Company, has suffered or been damaged through alteration, improper installation, mishandling, misuse, neglect, accident, or by removal or defacement of the factory serial number/bar code label(s). THE EXTENT OF THE COMPANY'S LIABILITY UNDER THIS WARRANTY IS LIMITED TO THE REPAIR OR REPLACEMENT PROVIDED ABOVE AND, IN NO EVENT, SHALL THE COMPANY'S LIABILITY EXCEED THE PURCHASE PRICE PAID BY PURCHASER FOR THE PRODUCT.

This Warranty is in lieu of all other express warranties or liabilities. ANY IMPLIED WARRANTIES, INCLUDING ANY IMPLIED WARRANTY OF MERCHANTABILITY, SHALL BE LIMITED TO THE DURATION OF THIS WRITTEN WARRANTY. ANY ACTION FOR BREACH OF ANY WARRANTY HEREUNDER INCLUDING ANY IMPLIED WARRANTY OF MERCHANTABILITY MUST BE BROUGHT WITHIN A PERIOD OF 24 MONTHS FROM DATE OF ORIGINAL PURCHASE. IN NO CASE SHALL THE COMPANY BE LIABLE FOR ANY CONSEQUENTIAL OR INCIDENTAL DAMAGES FOR BREACH OF THIS OR ANY OTHER WARRANTY, EXPRESS OR IMPLIED, WHATSOEVER. No person or representative is authorized to assume for the Company any liability other than expressed herein in connection with the sale of this product.

Some states do not allow limitations on how long an implied warranty lasts or the exclusion or limitation of incidental or consequential damage so the above limitations or exclusions may not apply to you. This Warranty gives you specific legal rights and you may also have other rights which vary from state to state.

U.S.A. : AUDIOVOX ELECTRONICS CORPORATION, 150 MARCUS BLVD, HAUPPAUGE, NEW YORK 11788  
I 1-800-645-4994

CANADA : CALL 1-800-645-4994 FOR LOCATION OF WARRANTY STATION SERVING YOUR AREA

128-5556G

© 2007 Audiovox Electronics Corporation



---

© 2007 Audiovox Electronics Corporation

128-8029

## Free Manuals Download Website

<http://myh66.com>

<http://usermanuals.us>

<http://www.somanuals.com>

<http://www.4manuals.cc>

<http://www.manual-lib.com>

<http://www.404manual.com>

<http://www.luxmanual.com>

<http://aubethermostatmanual.com>

Golf course search by state

<http://golfingnear.com>

Email search by domain

<http://emailbydomain.com>

Auto manuals search

<http://auto.somanuals.com>

TV manuals search

<http://tv.somanuals.com>