

OWNER'S MANUAL

AUDIOVOX

DVD PLAYER with VIDEO CASSETTE RECORDER AXWD2003

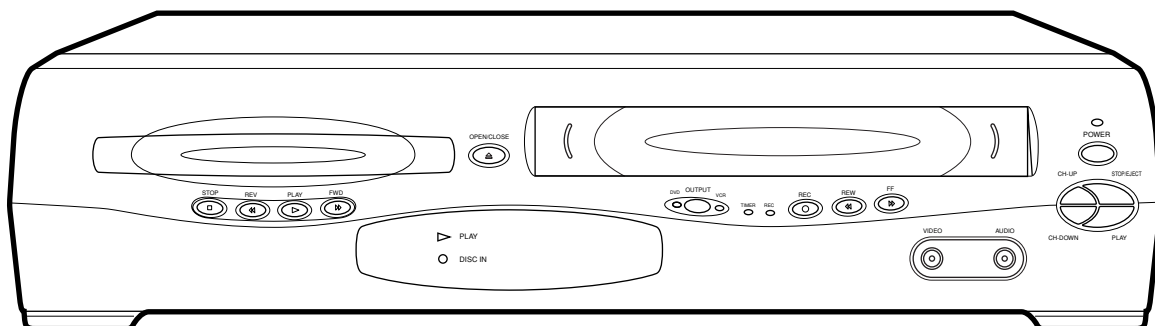

SERVICING

Should your DVD/VCR COMBINATION UNIT become inoperative, do not try to correct the problem by yourself. There are no user-serviceable parts inside. Turn off, unplug the power plug, and take the unit to our Authorized Service Center.

Please read before using this equipment.

WARNING:

TO REDUCE THE RISK OF FIRE OR ELECTRIC SHOCK, DO NOT EXPOSE THIS APPLIANCE TO RAIN OR MOISTURE.

**CAUTION**

RISK OF ELECTRIC SHOCK
DO NOT OPEN



The lightning flash with arrowhead symbol, within an equilateral triangle, is intended to alert the user to the presence of uninsulated “dangerous voltage” within the product’s enclosure that may be of sufficient magnitude to constitute a risk of electric shock to persons.



The exclamation point within an equilateral triangle is intended to alert the user to the presence of important operating and maintenance (servicing) instructions in the literature accompanying the appliance.

CAUTION:

TO REDUCE THE RISK OF ELECTRIC SHOCK, DO NOT REMOVE COVER (OR BACK). NO USER SERVICEABLE PARTS INSIDE. REFER SERVICING TO QUALIFIED SERVICE PERSONNEL.

LASER SAFETY

This unit employs a laser. Only a qualified service person should remove the cover or attempt to service this device, due to possible eye injury.

CAUTION: USE OF CONTROLS OR ADJUSTMENTS OR PERFORMANCE OF PROCEDURES OTHER THAN THOSE SPECIFIED HEREIN MAY RESULT IN HAZARDOUS RADIATION EXPOSURE.

CAUTION: VISIBLE AND INVISIBLE LASER RADIATION WHEN OPEN AND INTERLOCK DEFEATED. DO NOT STARE INTO BEAM.

LOCATION: INSIDE, NEAR THE DECK MECHANISM.

FCC WARNING- This equipment may generate or use radio frequency energy. Changes or modifications to this equipment may cause harmful interference unless the modifications are expressly approved in the instruction manual. The user could lose the authority to operate this equipment if an unauthorized change or modification is made.

RADIO-TV INTERFERENCE

This equipment has been tested and found to comply with the limits for a Class B digital device, pursuant to Part 15 of the FCC Rules. These limits are designed to provide reasonable protection against harmful interference in a residential installation. This equipment generates, uses, and can radiate radio frequency energy and, if not installed and used in accordance with the instructions, may cause harmful interference to radio communications. However, there is no guarantee that interference will not occur in a particular installation. If this equipment does cause harmful interference to radio or television reception, which can be determined by turning the equipment off and on, the user is encouraged to try to correct the interference by one or more of the following measures:

- 1) Reorient or relocate the receiving antenna.
- 2) Increase the separation between the equipment and receiver.
- 3) Connect the equipment into an outlet on a circuit different from that to which the receiver is connected.
- 4) Consult the dealer or an experienced radio/TV technician for help.

IMPORTANT SAFEGUARDS

1. Read Instructions - All the safety and operating instructions should be read before the appliance is operated.
2. Retain Instructions- The safety and operating instructions should be retained for future reference.
3. Heed Warnings - All warnings on the appliance and in the operating instructions should be adhered to.
4. Follow Instructions - All operating and use instructions should be followed.
5. Cleaning - Unplug this video product from the wall outlet before cleaning. Do not use liquid cleaners or aerosol cleaners. Use a damp cloth for cleaning. **EXCEPTION:** A product that is meant for uninterrupted service and, that for some specific reason, such as the possibility of the loss of an authorization code for a CATV converter, is not intended to be unplugged by the user for cleaning or any other purpose, may exclude the reference to unplugging the appliance in the cleaning description otherwise required in item 5.
6. Attachments - Do not use attachments not recommended by the video product manufacturer as they may cause hazards.
7. Water and Moisture- Do not use this video product near water, for example, near a bath tub, wash bowl, kitchen sink, or laundry tub, in a wet basement, or near a swimming pool, and the like.
8. Accessories - Do not place this video product on an unstable cart, stand, tripod, bracket, or table. The video product may fall, causing serious injury to a child or adult, and serious damage to the appliance. Use only with a cart, stand, tripod, bracket, or table recommended by the manufacturer, or sold with the video product. Any mounting of the appliance should follow the manufacturer's instructions and should use a mounting accessory recommended by the manufacturer. An appliance and cart combination should be moved with care. Quick stops, excessive force, and uneven surfaces may cause the appliance and cart combination to overturn.
9. Ventilation - Slots and openings in the cabinet are provided for ventilation and to ensure reliable operation of the video product and to protect it from overheating, and these openings must not be blocked or covered. The openings should never be blocked by placing the video product on a bed, sofa, rug, or other similar surface. This video product should not be placed in a built-in installation such as a bookcase or rack unless proper ventilation is provided or the manufacturer's instructions have been adhered to.
10. Power Sources - This video product should be operated only from the type of power source indicated on the marking label. If you are not sure of the type of power supply to your home, consult your appliance dealer or local power company. For products intended to operate from battery power, or other sources, refer to the operating instructions.
11. Grounding or Polarization - This video product is equipped with a polarized alternating-current line plug (a plug having one blade wider than the other). This plug will fit into the power outlet only one way. This is a safety feature. If you are unable to insert the plug fully into the outlet, try reversing the plug. If the plug should still fail to fit, contact your electrician to replace your obsolete outlet. Do not defeat the safety purpose of the polarized plug.
12. Power Cord Protection - Power supply cords should be routed so that they are not likely to be walked on or pinched by items placed upon or against them, paying particular attention to cords at plugs, convenience receptacles, and the point where they exit from the appliance.
13. Outdoor Antenna Grounding - If an outside antenna or cable system is connected to the video product, be sure the antenna or cable system is grounded so as to provide some protection against voltage surges and built-up static charges. Article 810 of the National Electrical Code, ANSI/NFPA No. 70, provides information with regard to proper ground-

ing of the mast and supporting structure, grounding of the lead-in wire to an antenna discharge unit, size of grounding conductors, location of antenna-discharge unit, connection to grounding electrodes, and requirements for the grounding electrode. (Fig. A)

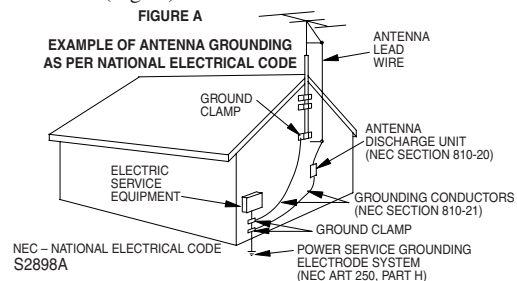

PORTABLE CART WARNING
(Symbol provided by RETAC)



14. Lightning - For added protection for this video product during a lightning storm, or when it is left unattended and unused for long periods of time, unplug it from the wall outlet and disconnect the antenna or cable system. This will prevent damage to the video product due to lightning and power-line surges.
15. Power Lines - An outside antenna system should not be located in the vicinity of overhead power lines or other electric light or power circuits, or where it can fall into such power lines or circuits. When installing an outside antenna system, extreme care should be taken to keep from touching such power lines or circuits as contact with them might be fatal.
16. Overloading - Do not overload wall outlets and extension cords as this can result in a risk of fire or electric shock.
17. Object and Liquid Entry - Never push objects of any kind into this video product through any openings as they may touch dangerous voltage points or short-out parts that could result in a fire or electric shock. Never spill liquid of any kind on the video product.
18. Servicing - Do not attempt to service this video product yourself as opening or removing covers may expose you to dangerous voltage or other hazards. Refer all servicing to qualified service personnel.
19. Damage Requiring Service - Unplug this video product from the wall outlet and refer servicing to qualified service personnel under the following conditions:
 - a. When the power-supply cord or plug is damaged.
 - b. If liquid has been spilled, or objects have fallen into the video product.
 - c. If the video product has been exposed to rain or water.
 - d. If the video product does not operate normally by following the operating instructions. Adjust only those controls that are covered by the operating instructions as an improper adjustment of other controls may result in damage and will often require extensive work by a qualified technician to restore the video product to its normal operation.
 - e. If the video product has been dropped or damaged in any way.
 - f. When the video product exhibits a distinct change in performance this indicates a need for service.
20. Replacement Parts - When replacement parts are required, be sure the service technician has used replacement parts specified by the manufacturer or have the same characteristics as the original part. Unauthorized substitutions may result in fire, electric shock or other hazards.
21. Safety Check - Upon completion of any service or repairs to this video product, ask the service technician to perform safety checks to determine that the video product is in proper operating condition.
22. Heat - This video product should be situated away from heat sources such as radiators, heat registers, stoves, or other products (including amplifiers) that produce heat.

A NOTE ABOUT RECYCLING

This product's packaging materials are recyclable and can be reused. Please dispose of all materials in accordance with your local recycling regulations.

Batteries should never be thrown away or incinerated but disposed of in accordance with your local regulations concerning chemical wastes.

The serial number of this product may be found on the back of the DVD/VCR COMBINATION UNIT. This serial number is unique to your machine. You should record the number and other vital information here and retain this book as a permanent record of your purchase to aid identification in case of theft. Serial numbers are not kept on file.



Date of Purchase	
Dealer Purchase from	
Dealer Address	
Dealer Phone No.	
Model No.	
Serial No.	

ABOUT COPYRIGHT

Unauthorized copying, broadcasting, public performance and lending of discs are prohibited.

This product incorporates copyright protection technology that is protected by method claims of certain U.S. patents and other intellectual property rights owned by Macrovision Corporation and other rights owners. Use of this copyright protection technology must be authorized by Macrovision Corporation, and is intended for home and other limited viewing uses only unless otherwise authorized by Macrovision Corporation. Reverse engineering or disassembly is prohibited.

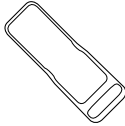
SUPPLIED ACCESSORIES

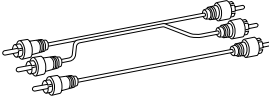
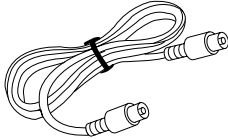
<p>Remote control</p>  <p>(NA209UD) or (NA259UD)</p>	<p>Two AA batteries</p> 	<p>A/V cables</p>  <p>(approx. 3 feet (100 cm) long) (WPZ0102TM015)</p>	<p>RF Cable</p>  <p>(WPZ0901TM002)</p>
---	---	--	---

SYMBOLS USED IN THIS MANUAL

The following symbols below appear in some headings and notes in this manual, with the following meanings

VCR

: Description refers to playback of video cassette tapes.

DVD-V

: Description refers to playback of DVD video discs.

CD

: Description refers to playback of audio CDs.

MP3

: Description refers to playback of MP3 discs.

QUICK

: Description refers to the items to be set in the QUICK mode.

TABLE OF CONTENTS

■ LASER SAFETY	2	■ PLAYING A DISC	22
■ IMPORTANT SAFEGUARDS	3	BASIC PLAYBACK	22
ABOUT COPYRIGHT	4	GENERAL FEATURES	22
SUPPLIED ACCESSORIES	4	PAUSE	22
SYMBOLS USED IN THIS MANUAL	4	DISC MENU	23
■ FEATURES	6	TITLE MENU	23
■ PRECAUTIONS	6	STEP BY STEP PLAYBACK	23
■ ABOUT THE DISCS	7	RESUME	23
PLAYABLE DISCS	7	FAST FORWARD / REVERSE SEARCH	23
DISC TYPES	7	SLOW FORWARD / SLOW REVERSE	23
■ OPERATING CONTROLS AND FUNCTIONS	8	ZOOM	24
LOADING THE BATTERIES	11	TRACK	24
■ VCR/DVD SWITCHING	12	TITLE / CHAPTER SEARCH	24
■ HOOKUPS	13	TIME SEARCH	24
CONNECTING TO A TV WITHOUT A/V TERMINALS	13	REPEAT	25
CONNECTING TO A TV WITH A/V TERMINALS	13	PROGRAM	25
CONNECTING TO A TV THAT HAS AN S-VIDEO INPUT JACK OR COMPONENT VIDEO IN JACKS	14	RANDOM PLAYBACK	26
CONNECTING TO A STEREO AMPLIFIER EQUIPPED WITH DIGITAL INPUT JACKS SUCH AS MD DECK OR DAT DECK	14	MP3 PLAYBACK	26
CONNECTING TO A RECEIVER WITH DOLBY DIGITAL DECODER	15	ON-SCREEN INFORMATION	26
CONNECTING TO AN ANALOG AUDIO SYSTEM	15	TRACK SELECTION	26
■ SETUP	16	RANDOM PLAYBACK	27
AUTOMATIC CHANNEL SET UP	16	PROGRAM	27
TO CHANGE THE ON-SCREEN LANGUAGE	17	AUDIO LANGUAGE	27
CLOCK SET UP	17	STEREO SOUND MODE	27
■ PLAYBACK FUNCTION	18	SUBTITLE LANGUAGE	27
NORMAL PLAYBACK	18	CAMERA ANGLE	27
AUTO REPEAT PLAYBACK	18	CHANGING THE ON-SCREEN DISPLAY	28
SEARCH FUNCTIONS	18	PARENTAL CONTROL	28
■ RECORDING FUNCTION	19	MARKER SETUP SCREEN	29
NORMAL RECORDING	19	■ DVD SETUP	29
OTR (One Touch Recording)	19	AUDIO SETTING	29
TIMER RECORDING	19	BLACK LEVEL SETTING	30
HINTS FOR TIMER RECORDING	20	VIRTUAL SURROUND	30
■ SPECIAL FEATURES	21	DISPLAY SETTING	30
COPYING A VIDEO TAPE	21	LANGUAGE SETTING	31
AUTO REWIND	21	■ TROUBLESHOOTING GUIDE	32
REAL TIME TAPE COUNTER	21	■ SPECIFICATIONS	34

INDICE

■ CONTROLES DEL FUNCIONAMIENTO Y SUS FUNCIONES	35
■ CAMBIO DE VCR/DVD	38
■ CONEXIONES	39
DVD/VCR A CONEXIÓN DE TV	39
CANAL DE SALIDA RF	39
CONECTANDO A UN TV	39
CONECTANDO A UN TV QUE TIENE TOMA DE ENTRADA DE S-VÍDEO o TOMAS DE ENTRADA DE VÍDEO COMPONENTE	39
CONECTANDO A UN AMPLIFICADOR EQUIPADO CON TOMAS DE ENTRADA DIGITAL, TALES COMO PLATINA MD O PLATINA DAT	39
CONECTANDO A UN DESCODIFICADOR DIGITAL DOLBY	39
CONECTANDO A UN AUDIO ANALÓGICO	39
■ PREPARACIÓN	39
PREPARACIÓN DE CANAL AUTOMÁTICA	39
PREPARACIÓN DE RELOJ	40
■ REPRODUCCIÓN DE UN DISCO	40
REPRODUCIENDO UN DVD, VIDEO O UN CD AUDIO	40

FEATURES

DVD Mode

- **Dolby Digital sound**

This DVD/VCR COMBINATION UNIT can output a Dolby Digital audio signal.

- **Still/fast/slow/step playback**
- **Random playback for audio CD and MP3**
- **Program playback for audio CD and MP3**
- **DVD menus in a desired language**
- **Screen saver/Auto power-off functions**

The screen saver program starts when there is no input from the player for five minutes in the stop mode. When the screen saver program is activated for 30 minutes, the power automatically turns off.

- **Subtitles in a desired language**
- **Selecting a camera angle**
- **Choices for audio language and sound mode**
- **Parental lock**
- **Automatic detection of discs**

This player automatically detects if the loaded disc is DVD, audio CD or MP3 on disc.

- **Playback an MP3 disc**
- **Direct Search**
- **On-screen display**

Information about the current operation can be displayed on the TV screen, allowing you to confirm the currently active functions (such as program playback), on the TV screen using the remote control.

- **Search**
Chapter search / Title search / Track search / Time search
- **Repeat**
Chapter / Title / Track / Group / All / A-B
- **Zoom**
- **Marker**
The part designated by user can be called back.
- **Resume Play**

- **Virtual Surround Sound**

- **Component Video Out Jacks**

Jacks located on the back of the DVD/VCR COMBINATION UNIT which are used to send high-quality video to a TV via Component Video In Jacks.

- **Bit rate indication**
- **DRC (Dynamic range control)**
You can control the range of sound volume.
- **Black Level Setting**

VCR Mode

Hardware specifications

- **Auto Head Cleaner**
- **Trilingual on-screen menu display selectable in English, French, or Spanish**
- **181 channel capability PLL frequency synthesizer tuner with direct station call**
(A cable converter box may be necessary to view scrambled cable channels.)

Automatic functions

- **Auto power on system**
Automatically turns the VCR on when you insert the cassette.
- **Digital Auto Tracking (DTR)**

Playback

- **Auto Repeat**
- **2 Step Picture Search Operation**
- **Index Search**
- **Time Search**

Recording

- **1 Year, 8 events (including Daily and Weekly Timer Recording)**
- **OTR (One Touch Recording)**

PRECAUTIONS

INSTALLATION LOCATION

For safety and optimum performance of your DVD/VCR COMBINATION UNIT:

- Install the DVD/VCR COMBINATION UNIT in a horizontal and stable position. Do not place anything directly on top of the DVD/VCR COMBINATION UNIT. Do not place the DVD/VCR COMBINATION UNIT directly on top of the TV.
- Shield it from direct sunlight and keep it away from sources of intense heat. Avoid dusty or humid places. Avoid places with insufficient ventilation for proper heat dissipation. Do not block the ventilation holes on the sides of the DVD/VCR COMBINATION UNIT. Avoid locations subject to strong vibration or strong magnetic fields.

AVOID THE HAZARDS OF ELECTRICAL SHOCK AND FIRE

- Do not handle the power cord with wet hands.
- Do not pull on the power cord when disconnecting it from AC wall outlet. Grasp it by the plug.
- If, by accident, water is spilled on your DVD/VCR COMBINATION UNIT, unplug the power cord immediately and take the unit to our Authorized Service Center for servicing.
- Do not put your fingers or objects into the DVD/VCR COMBINATION UNIT cassette holder.

MOISTURE CONDENSATION WARNING

Moisture condensation may occur inside the unit when it is moved from a cold place to a warm place, or after heating a cold room or under conditions of high humidity. Do not use the DVD/VCR COMBINATION UNIT at least for 2 hours until its inside is dry.

ABOUT THE DISCS

PLAYABLE DISCS

The following discs can be played back on this DVD/VCR COMBINATION UNIT.

- DVD video
- DVD-R/RW*
- DVD+R/RW*
- Audio CD
- CD-R/RW*
- MP3*

* Depending on the types or the writing method of the medium some discs can not be played.

- Some DVD-R/RW, DVD+R/RW, or CD-R/RW discs made on personal computers, or on DVD recorders may not be played back properly due to factors such as scratches, dirt or special properties of the disc.
- Discs made on personal computers may not be played back properly due to different environments or the settings of the application you use. We recommend always to use the standardized, properly formatted discs. (Please contact the sales agency for more detail).

This player conforms to the NTSC color system. You cannot play discs recorded in other color systems such as PAL or SECAM.

- Some discs include region codes as shown below.



- The number inside the symbol refers to a region of the world, and a disc encoded in a specific region format can only be played back on DVD/VCR COMBINATION UNIT with the same region code.

The following discs cannot be played back on this DVD/VCR COMBINATION UNIT.

- DVD with region codes other than 4 or ALL.
- DVD-ROM
- DVD-RAM (Never play back, otherwise malfunction may result.)
- CD-ROM
- VSD
- CDV (Only plays back the audio part.)
- CD-G (Only plays back the sound.)
- CD-I (Never play back, otherwise malfunction may result.)
- SACD
- Photo CD (Never play back, otherwise malfunction may result.)
- Video CD (Never play back, otherwise malfunction may result.)

Any other discs without compatibility indications.

DISC TYPES

[DVD]

Data on a DVD is divided into sections called "titles", and then into subsections called "chapters", each of which is given a title or chapter number. Playback conditions are preset on some DVD video discs, and these playback conditions take priority over user operations on this player. If a function you selected does not run as desired, refer to the manual accompanying the disc.

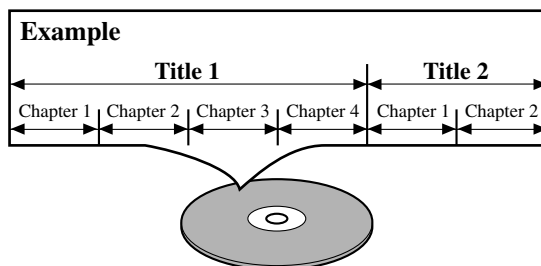

[AUDIO CD]

Data on an audio CD is divided into sections called "tracks", each of which is given a track number.

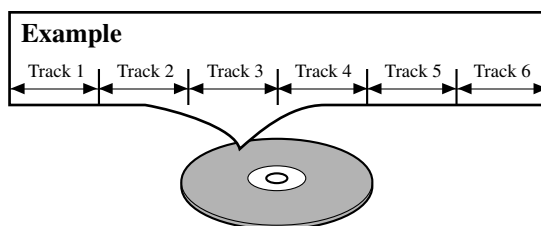

[MP3]

Data on an MP3 is divided into sections called "groups", and then into subsections called "tracks", each of which is given a group or track number.

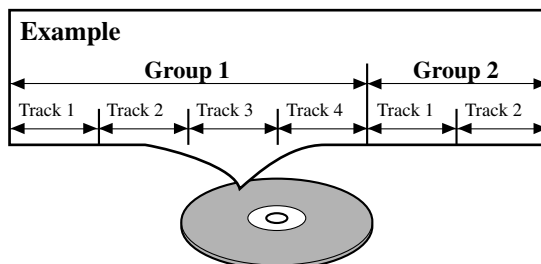

OPERATING CONTROLS AND FUNCTIONS

FRONT PANEL

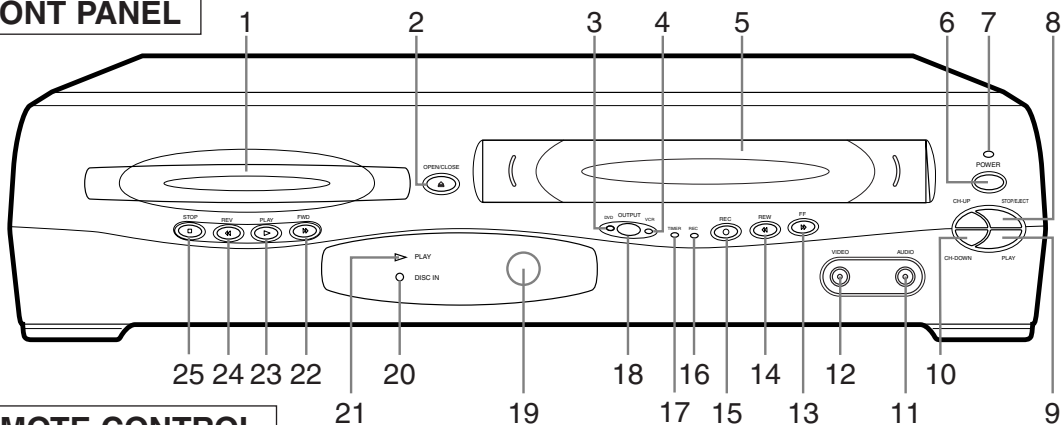

REMOTE CONTROL

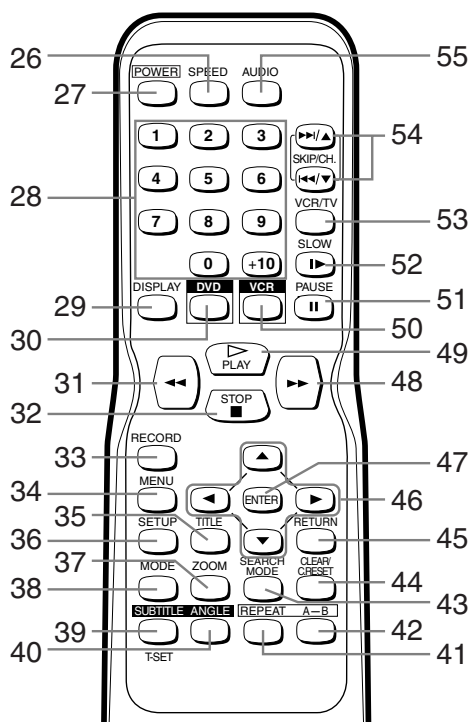

1. **Disc loading tray**
2. **OPEN/CLOSE Button [page 22]**
Press to insert discs into or remove them from the tray.
3. **DVD OUTPUT Light (Green) [page 12]**
This light appears when the DVD output mode is selected. You can only watch DVDs when the green DVD OUTPUT light is on. To make the green DVD OUTPUT light come on, press DVD on the remote control or OUTPUT on the front panel.
4. **VCR OUTPUT Light (Green) [page 12]**
This light appears when the VCR output mode is selected. You can only watch tapes when the green VCR OUTPUT light is on. To make the green VCR OUTPUT light come on, VCR on the remote control or OUTPUT on the front panel.
5. **CASSETTE COMPARTMENT**

6. **POWER Button [page 16]**
Press to turn the power on and off.
7. **POWER Light (red)**
Light appears when the power is on.
8. **STOP/EJECT Button (VCR) EJECT Button**
Press to remove the tape from the VCR.
STOP Button
Press to stop the tape motion.
9. **PLAY Button(VCR) [page 18]**
Press to begin playback.
10. **CH(ANNEL) Buttons [page 16]**
In VCR mode, press to change TV channels on the VCR; press to adjust the tracking during normal or slow motion playback; press to remove vertical jitter in a Still picture.
11. **AUDIO In Jack [page 21]**
Connect an audio cable coming from the audio out jack of a camcorder, another VCR, or an audio source here.
12. **VIDEO In Jack [page 21]**
Connect a video cable coming from the video out jack of a camcorder, another VCR, or a video source (laser disc player, camcorder, etc.) here.
13. **FF Button (VCR) [page 18]**
Press to rapidly advance the tape, or view the picture rapidly in forward during playback. (Forward Search).
14. **REW Button (VCR) [page 18]**
Press to rewind the tape, or to view the picture rapidly in reverse during the playback mode (Rewind Search).
15. **REC Button [page 19]**
Press once to start a recording. Press repeatedly to start a One-Touch Recording.
16. **REC Light [page 19]**
Light appears during recording.
17. **TIMER Light [page 19]**
Light appears when the DVD/VCR is in standby mode for a timer recording or during a One-Touch Recording. It flashes if T-SET is pressed for a timer recording, but there is no tape in the DVD/VCR. It flashes when all timer recordings or One-Touch Recordings are finished.

- 18. OUTPUT Button [page 12]**
Press to select DVD mode or VCR mode.
- You can switch the output mode either by pressing OUTPUT on the front panel, or by pressing DVD or VCR on the remote control. However, **if you press OUTPUT on the front panel first, you need to re-select the corresponding mode by pressing DVD or VCR on the remote control.**
- 19. Remote Sensor Window**
- 20. DISC IN Light (green)**
Light appears when a disc is in the DVD Player.
- 21. PLAY Light (green)**
Light appears during Disc playback.
- 22. FWD Button (DVD) [page 23]**
Press to fast forward the Disc. Press PAUSE, then press this button to begin slow motion playback. Press this button repeatedly to change the forward speed of slow motion.
Press to skip Chapters or Tracks.
- 23. PLAY Button (DVD) [page 22]**
Press to begin playback.
- 24. REV Button (DVD) [page 23]**
Press to view the DVD picture in fast reverse motion or to reverse playback of an Audio CD.
Press to skip Chapters or Tracks.
- 25. STOP Button (DVD) [page 22]**
Stops operation of the disc.
- 26. SPEED Button [page 19]**
Press to select the VCR's recording speed (SP or SLP)
- 27. POWER Button**
Press to turn the power on and off.
- 28. Number Buttons**
- **DVD mode [page 24]**
Press to select numbered items in a menu.
+10
Use this button to enter number 10 and above.
 - **VCR mode [page 16]**
Press to select TV channels on the VCR.
To select channels, enter channel numbers as a two-digit number for the quickest results. For example, to select channel 6, press 0 then 6.
- 29. DISPLAY Button**
- **DVD mode [page 28]**
Press to access or remove the display screen during DVD or Audio CD playback.
 - **VCR mode**
Press to access or remove the VCR's on-screen status display.
- 30. DVD Button [page 12]**
Press to select DVD mode for the remote control.
- You can switch the OUTPUT mode either by pressing OUTPUT on the front panel, or by pressing DVD or VCR on the remote control. However, **if you press OUTPUT on the front panel first, you need to re-select the corresponding mode by pressing DVD or VCR on the remote control.**
- 31. ◀◀ Button**
- **DVD mode [page 23]**
Press to view the DVD picture in fast reverse motion. Press PAUSE, then press this button to begin slow motion playback. Press this button repeatedly to change the reverse speed of slow motion.
 - **VCR mode [page 18]**
Press to rewind the tape, or to view the picture rapidly in reverse during the playback mode (Rewind Search).
- 32. STOP Button**
- **DVD mode**
Press to stop the disc motion.
 - **VCR mode**
Press to stop the tape motion.
- 33. RECORD Button [page 19]**
Press once to start a recording.
- 34. MENU Button**
- **DVD mode [page 23]**
Press to display the menu of the Disc.
 - **VCR mode [page 17]**
Press to access the VCR menu.
- 35. TITLE Button [page 23]**
- 36. SETUP Button [pages 28-31]**
Press to enter DVD player setup mode.
- 37. ZOOM Button [page 24]**
Enlarges part of a DVD-reproduced image.
- 38. MODE Button [pages 26,27,and 30]**
Activates program playback or random playback mode when playing CDs or MP3. Sets Black level and virtual surround.
- 39. SUBTITLE Button [page 27]**
Press to select the desired subtitle language.
- T-SET Button [page 19]**
Press to put the VCR into standby mode for a timer recording.
- 40. ANGLE Button [page 27]**
Press to change the camera angle to see the sequence being played back from a different angle.
- 41. REPEAT Button [page 25]**
Repeats playback of the current disc, title, chapter or track.
- 42. A-B REPEAT Button [page 25]**
Repeats playback of a selected section.
- 43. SEARCH MODE Button**
- **DVD mode [page 24]**
Press to access or remove the Search display, which allows you to go directly to a specific Title/Chapter/Track/Time.
 - **VCR mode [page 18]**
Press to perform a Time Search or an Index Search.
- 44. CLEAR/C.RESET Button**
- **DVD mode [pages 24,25]**
Press to reset the setting.
 - **VCR mode [page 16]**
Press to reset the counter. Press to exit from the MENU screen.
- 45. RETURN Button [page 30]**
- **DVD mode**
Returns to the previous operation.
- 46. Arrow Buttons**
- Use when making settings while watching the display on a TV screen.
- **DVD mode [pages 22-31]**
Moves the cursor and determines its position.
 - **VCR mode [page 16]**
- ▼/▲ Buttons**
Press to enter digits when setting program (For example: setting clock or timer program). Press to select the setting modes from the on screen menu.
- ▶ Button**
When setting program (For example: setting clock or timer program), press to determine your selection and proceed to the next step you want to input. Press to determine the setting modes from the on screen menu. Press to add or delete channel numbers during channel preset.

◀Button

Press to cancel a setting of timer program. Press to correct digits when setting program (For example: setting clock or timer program). Press to add or delete channel numbers during channel preset.

47. ENTER Button

● DVD mode [page 22]

Press to accept a setting.

48. ►► Button

● DVD mode [page 23]

Press to fast forward the Disc. Press PAUSE, then press this button to begin slow motion playback. Press this button repeatedly to change the forward speed of slow motion.

● VCR mode [page 18]

Press to rapidly advance the tape, or view the picture rapidly in forward during playback (Forward Search).

49. PLAY Button

● DVD mode

Press to begin playback.

● VCR mode

Press to begin playback.

50. VCR Button [page 12]

Press to select VCR mode for the remote control.

● You can switch the OUTPUT mode either by pressing OUTPUT on the front panel, or by pressing DVD or VCR on the remote control. However, **if you press OUTPUT on the front panel first, you need to re-select the corresponding mode by pressing DVD or VCR on the remote control.**

51. PAUSE Button

● DVD mode [page 22]

Press to pause Disc playback. Press repeatedly to advance the DVD picture step by step (or one frame at a time).

● VCR mode [page 18]

While recording, press to temporarily stop the recording (pause). Press a second time to resume normal recording. You can not pause a One-Touch Recording. Or, press during tape playback to freeze the picture. Press to advance the picture one frame at a time during still mode.

52. SLOW Button [page 18]

During tape playback, press to view the video tape in slow motion. Press again to resume normal playback. This button does not affect DVD playback.

53. VCR/TV Button [page 19]

Use to select VCR or TV position.

● VCR Position

To view playback, to monitor video recording or to watch TV using the VCR tuner.

● TV Position

To watch TV or to view one program while recording another.

54. SKIP/CH. Buttons

● DVD mode

Press to skip Chapters or Tracks.

● VCR mode

Press to change TV channels on the VCR.

55. AUDIO Button [page 27]

Press to select a desired audio language or sound mode.

Notes

- To use the remote control to operate the DVD/VCR COMBINATION UNIT and its features, press DVD on the remote control before pressing other DVD operation button. Verify that the green DVD OUTPUT Light is on.
- To use the remote control to operate the VCR and its features, press VCR on the remote control before pressing other VCR operation button. Verify that the green VCR OUTPUT Light is on.

REAR VIEW

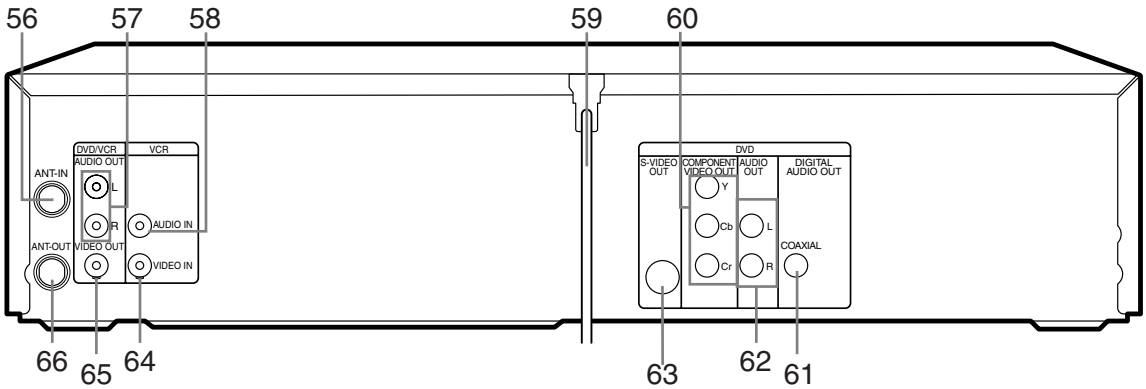

56. ANT-IN (Antenna In) Jack

Connect your antenna, Cable Box, or Satellite decoder box.

57. DVD/VCR AUDIO OUT Jacks

Connect the supplied audio cables here and to the Audio In jacks of a television or other audio equipment.

58. AUDIO IN Jack

Connect an audio cable coming from the audio out jack of a camcorder, another VCR, or an audio source here.

59. AC Power Cord

Connect to a standard AC outlet to supply power to the DVD/VCR COMBINATION UNIT.

DVD Playback only

60. COMPONENT VIDEO OUT Jacks

Connect optional component video cables here and to the component Video In jacks of a television.

61. COAXIAL Jack

Connect an optional coaxial digital audio cable here and to the Coaxial Digital Audio In jack of a decoder or audio receiver.

62. DVD ANALOG AUDIO OUT Jacks

Connect the supplied audio cables here and to the Audio In jacks of a television or other audio equipment (DVD only).

63. S-VIDEO OUT Jack

Connect an optional S-Video cable here and to the S-Video In jack of a television. (DVD only).

64. VIDEO IN Jack

Connect a cable coming from the video out jack of a camcorder, another VCR, or an audio-visual source (laser disc player, video disc player, etc.) here.

65. DVD/VCR VIDEO OUT Jack

Connect the yellow video cable (supplied) here and to the TV's Video In jack.

66. ANT-OUT (Antenna Out) Jack

Use the supplied RF coaxial cable to connect this jack to the ANTENNA IN Jack on your TV.

Notes

- The S-VIDEO OUT jack, COAXIAL jack, and COMPONENT VIDEO OUT jack are only useful in DVD mode.

Caution: Do not touch the inner pins of the jacks on the rear panel. Electrostatic discharge may cause permanent damage to the player.

LOADING THE BATTERIES

1. Open the battery compartment cover.
2. Insert two AA batteries (supplied), with each one oriented correctly.
3. Close the cover.

Notes

- Do not mix alkaline and manganese batteries.
- Do not mix old and new batteries.

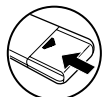
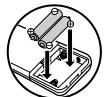

VCR/DVD SWITCHING

Because this product is a combination of a VCR and DVD player, you must first select which component you wish to operate with the OUTPUT BUTTON.

VCR MODE

Press VCR on the remote control.
(Verify that the VCR OUTPUT Light is lit.)

DVD MODE

Press DVD on the remote control.
(Verify that the DVD OUTPUT Light is lit.)

Notes

- Pressing only OUTPUT on the front panel does not switch the mode of the remote control. You always need to select the correct mode on the remote control too.

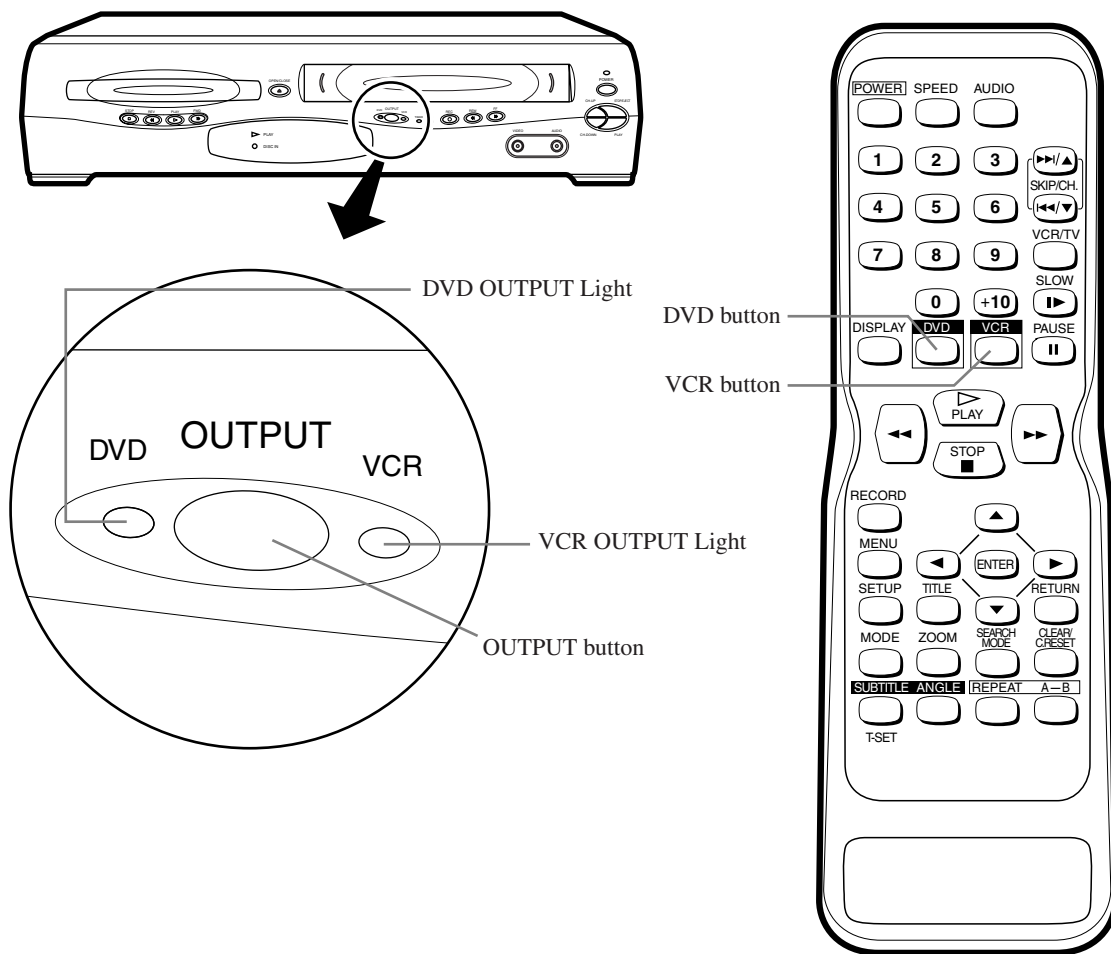

HOOKUPS

CAUTION:

- Be sure to turn off the DVD/VCR COMBINATION UNIT and equipment to be connected.
- Read through the operation manual for the equipment to be connected.
- Be sure that the colors of the jacks and plugs match up when using VIDEO/AUDIO cables.
- Be sure to keep the DVD/VCR COMBINATION UNIT connection cables separate from the TV antenna cable when you install the DVD/VCR COMBINATION UNIT, because it may cause electrical interference when you are watching television programs.

CONNECTING TO A TV WITHOUT A/V TERMINALS

1. Disconnect the AC power cord of the TV from the AC outlet.
2. Disconnect the antenna or cable from the TV.
3. Connect the antenna or cable to the ANT-IN jack of the DVD/VCR COMBINATION UNIT.
4. Connect the DVD/VCR COMBINATION UNIT to the TV using the RF cable.
5. Plug the AC power cords of the DVD/VCR COMBINATION UNIT and TV into the AC outlets.

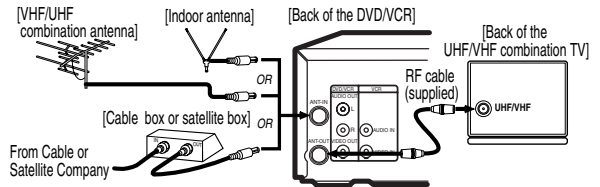

RF OUTPUT CHANNEL for DVD/VCR

1. Connect the DVD/VCR COMBINATION UNIT to a TV using RF cable (see above steps).
2. Select channel 3 on your TV.
3. Press PLAY.
 - If noise appears, change the RF output channel of the DVD/VCR COMBINATION UNIT to channel 4 by pressing PLAY on the VCR for 3 seconds during playback.
 - There is case that the RF output channel does not change by situation (For example, when you adjust tracking using CHANNEL(UP/DOWN)). In this case, stop the playback, and start the playback again. After that, press PLAY on the VCR for 3 seconds.
 - If there is a power failure or the DVD/VCR COMBINATION UNIT is unplugged for more than 30 seconds, the RF output channel setting will return to CH3.

Note to CATV system installer

This reminder is provided to call the CATV system installer's attention to Article 820-40 of the NEC that provides guidelines for proper grounding and, in particular, specifies that the cable ground should be connected to the grounding system of the building, as close to the point of cable entry as practical.

CONNECTING TO A TV WITH A/V TERMINALS

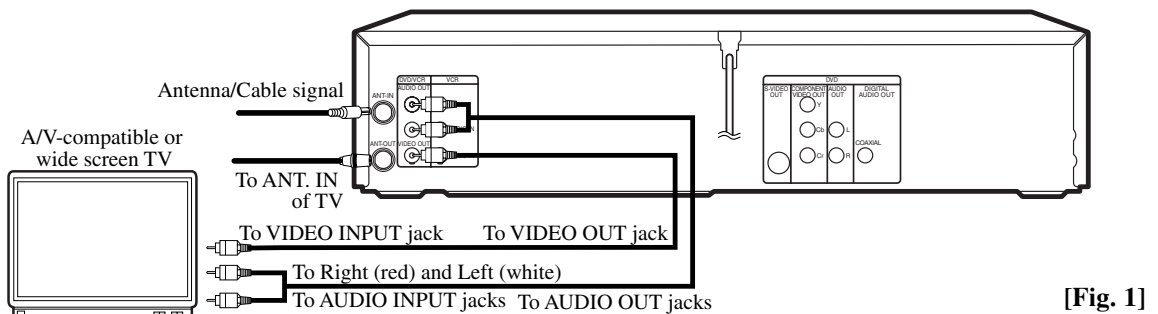

[Fig. 1]

Notes

- Connect the DVD/VCR COMBINATION UNIT directly to a TV. If the A/V cables are connected into a VCR, pictures may be distorted due to the copy protection system.

CONNECTING TO A TV THAT HAS AN S-VIDEO INPUT JACK OR COMPONENT VIDEO IN JACKS

FOR TVs WITH S-VIDEO INPUT JACK

Use an S-Video cable (commercially available) in place of the yellow video cable to enjoy higher quality pictures.

The S-Video connection only supplies video (picture) in the DVD mode of the DVD/VCR COMBINATION UNIT. Therefore, in order to use the VCR features or view TV channels on the DVD/VCR COMBINATION UNIT, you still need to either connect the RF cable between the ANT-OUT jack of the DVD/VCR COMBINATION UNIT and the TV's Antenna In jack, or connect the yellow video cable as described earlier (Fig. 1). To connect the supplied RF cable, see page 13.

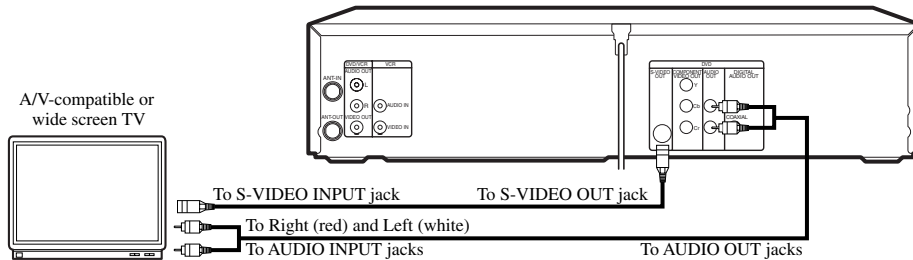

[Fig. 2]

FOR TVs WITH COMPONENT VIDEO IN JACKS

Use a component video cable (commercially available) in place of the yellow DVD/VCR video cable and S-VIDEO cable to enjoy higher quality pictures.

The component video connection only supplies video (picture) in the DVD mode of the DVD/VCR COMBINATION UNIT. Therefore, in order to use the VCR features or view TV channels at the DVD/VCR COMBINATION UNIT, you still need to either connect the RF coaxial cable between the ANT-OUT jack of the DVD/VCR COMBINATION UNIT and the TV's Antenna In jack, or connect the yellow VCR video cable as described earlier (Fig. 1). To connect the supplied RF cable, see page 13.

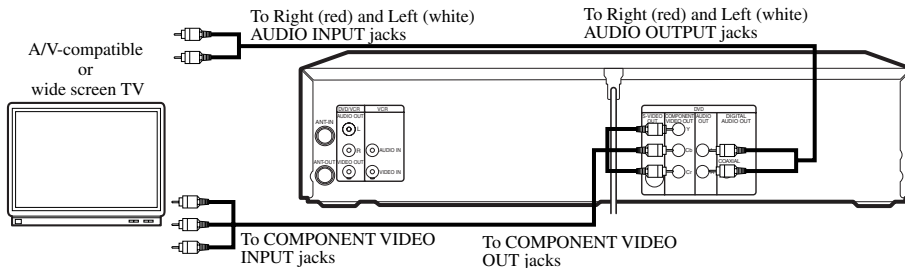

[Fig. 3]

CONNECTING TO A STEREO AMPLIFIER EQUIPPED WITH DIGITAL INPUT JACKS SUCH AS MD DECK OR DAT DECK

Use an audio coaxial digital cable (commercially available) for the audio connections.

Connecting to an amplifier equipped with digital input jacks such as MD Deck or DAT Deck.

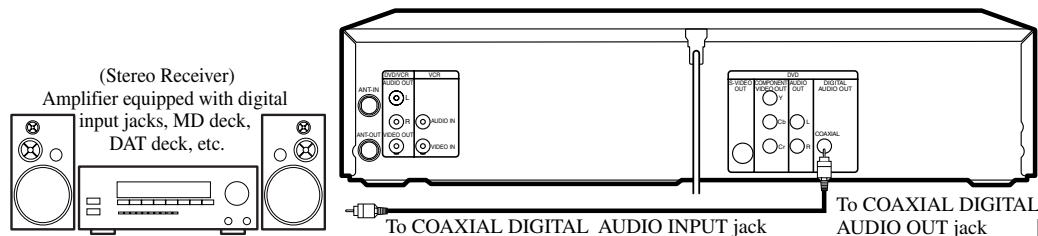

[Fig. 4]

Notes

- The audio source on a disc in the 5.1 channel Dolby Digital surround format cannot be recorded as digital sound by an MD or DAT deck.
- Set DOLBY DIGITAL to OFF for audio output in the setup mode. Playing a DVD disc using incorrect settings may generate noise distortion, and may also damage the speakers. (See page 29 to set DOLBY DIGITAL to ON)

CONNECTING TO A RECEIVER WITH DOLBY DIGITAL DECODER

If using this DVD/VCR COMBINATION UNIT to play a DVD disc in 5.1 channel Dolby Digital surround, the DVD/VCR COMBINATION UNIT outputs a Dolby Digital data stream from its COAXIAL DIGITAL AUDIO OUT jack. By hooking the DVD/VCR COMBINATION UNIT up to a Dolby Digital receiver, you can enjoy a more convincing, realistic ambience with powerful and high-quality surround sound as heard in movie theaters. Use an audio coaxial digital cable (commercially available) for the audio connections.

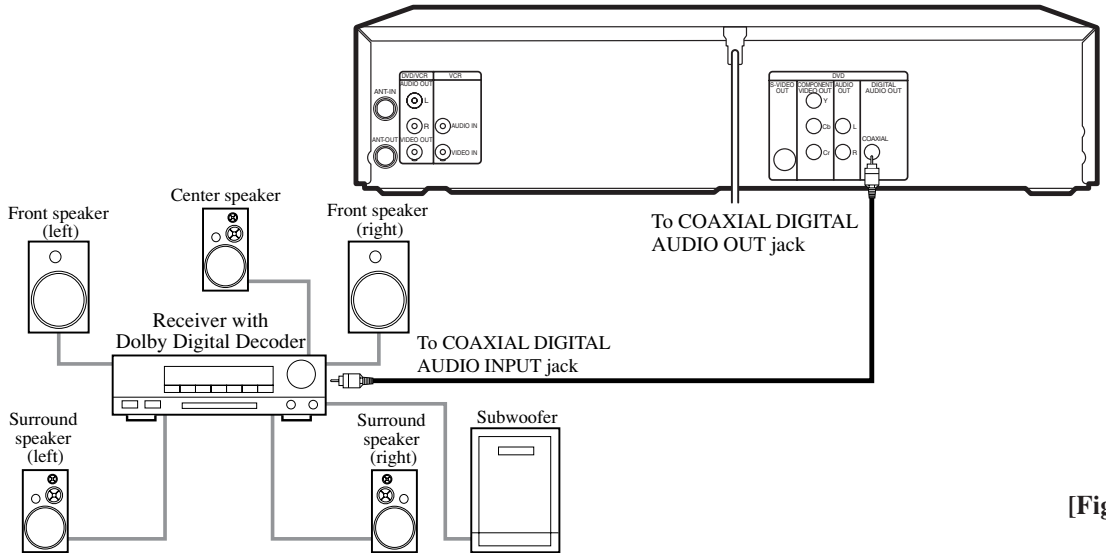

[Fig. 5]

- If the output is Dolby Digital audio, connect to a Dolby Digital decoder, and set DOLBY DIGITAL to ON for audio output in the setup mode.
- Unless connected to a Dolby Digital receiver, set DOLBY DIGITAL to OFF for audio output in the setup mode. Playing a DVD using incorrect settings may generate noise distortion, and may also damage the speakers.

Manufactured under license from Dolby Laboratories. “Dolby” and the double-D symbol are trademarks of Dolby Laboratories.

CONNECTING TO AN ANALOG AUDIO SYSTEM

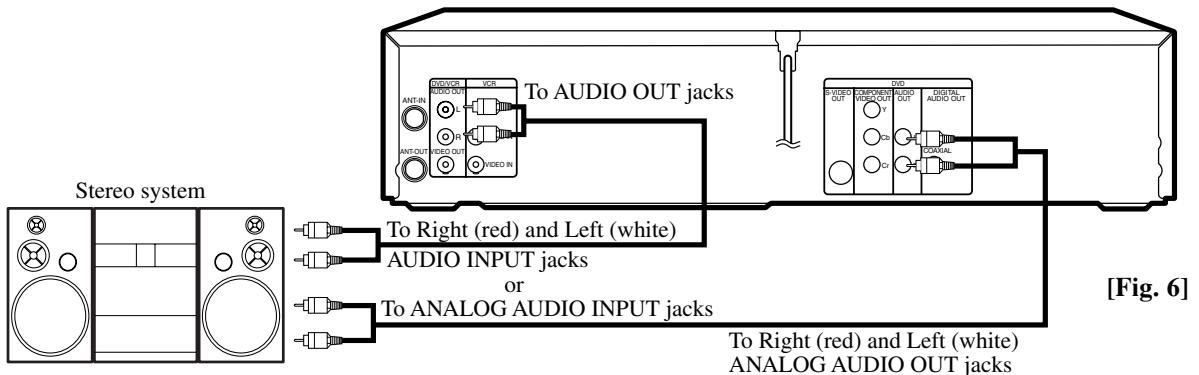

[Fig. 6]

Notes

- Be sure to turn off the power to all components in the system before connecting another component.
- Refer to the Owner's Manuals for stereo systems and any other components to be connected to the DVD/VCR COMBINATION UNIT.

AUTOMATIC CHANNEL SET UP

VCR

You can automatically program the tuner to scan only the channels you receive in your area.

- Channel memory programming is NOT needed when you connect the VCR to a cable box or a satellite box as in "CONNECTING TO A TV WITHOUT A/V TERMINALS" on page 13. In this case, select channel 3 on your TV. Then, the channel you want to record or view may be selected at the cable box or satellite box.
- If noise appears, change the RF output channel of the VCR to channel 4 by pressing PLAY for 3 seconds during playback. Then select the same channel (CH4) on your TV.
- Follow the steps below once. Repeat only if there is a power failure or if the VCR is unplugged for more than 30 seconds. (In these cases, the programmed channels are erased.)
- You must follow the steps below before attempting to play or record a video tape. If you want to play or record a video tape BEFORE programming the tuner, you can cancel it by pressing CLEAR/C.RESET.

1 You need to connect the antenna or cable to the VCR first. Then, connect the DVD /VCR power plug to a standard AC outlet.

2 Turn on the TV and set the TV to channel 3.

- If noise appears, change the RF output channel of the VCR to channel 4 by pressing PLAY for 3 seconds during playback. Then select the same channel (CH4) on your TV. (See "RF OUTPUT CHANNEL" on page 13 for the detail.)

3 Turn on the VCR by pressing POWER. the POWER light will come on.

4 Select the On Screen Language ("ENGLISH", "FRANCAIS" or "ESPAÑOL") by pressing ▲ or ▼. Then, press ►.

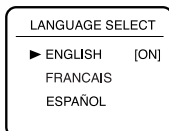

5 Begin channel preset by pressing ► once. The tuner scans and memorizes all active channels in your area.

- The VCR distinguishes between standard TV channels and cable channels.

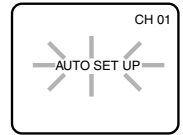

6 After scanning, the tuner stops on the lowest memorized channel. The TV screen returns to TV mode.

- If "AUTO SET UP" appears on the TV screen again, check the cable connections. Press ► once again and the VCR will begin preset again.

TO SELECT A DESIRED CHANNEL

You can select the desired channel by using CHANNEL (UP/DOWN) or by directly pressing Number on the remote control.

Note for using the Number:

- When selecting cable channels which are higher than 99, enter channel numbers as a three-digit number. (For example: 117, press 1,1,7)
- You must precede single-digit channel numbers with a zero (For example: 02, 03, 04 and so on).

TO PRESET THE CHANNELS AGAIN

1 Press MENU until the main menu appears. (If you have already set the clock, you only have to press it once. If not, you have to press it twice).

2 Select "CHANNEL SET UP" by pressing ▲ or ▼. Then, press ►.

3 Select "TV" or "CATV" by pressing ▲ or ▼. Then, press ►.

- After scanning, the tuner stops on the lowest memorized channel.

TO ADD/DELETE CHANNELS

When scanning, some channels may be skipped due to a weak signal. In such cases, you can add the channels to the VCR memory manually.

- 1 Press **MENU** until the main menu appears. (If you have already set the clock, you only have to press it once. If not you have to press it twice).

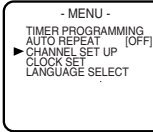

- 2 Select "**CHANNEL SET UP**" by pressing **▲** or **▼**. Then, press **▶**.
- 3 Select "**MANUAL SET UP**" by pressing **▲** or **▼**. Then, press **▶**.
- 4 Enter the desired channel number by pressing **▲** or **▼**.
- 5 Add or Delete it from memory by pressing **▶** or **◀** so that "**ADD**" or "**DELETE**" flashes on the TV screen accordingly.
- 6 Exit the Preset mode by pressing **CLEAR/C.RESET**.

TO CHANGE THE ON-SCREEN LANGUAGE

VCR

- 1 Press **MENU** twice to call up the main menu. (If you have already set the clock, you only have to press it once).
 - 2 Select "**LANGUAGE SELECT**" by pressing **▲** or **▼**. Then, press **▶**.
 - 3 Select "**ENGLISH**", "**FRANCAIS**" or "**ESPAÑOL**" by pressing **▲** or **▼**. Then, press **CLEAR/C.RESET**.
- If you accidentally select Spanish or French and need English: Press **MENU** and choose **SELEC. IDIOMA**, or **SELECTION LANGUE**. Press **▶**, and select **ENGLISH** by pressing **▲** or **▼**. Finally, press **CLEAR/C.RESET**.

CLOCK SET UP

VCR

- 1 Select main menu by pressing **MENU**.

- If the clock is not set, the **CLOCK SET** menu appears first. In this case, follow step [3].

- 2 Select "**CLOCK SET**" by pressing **▲** or **▼**. Then, press **▶**.
- 3 Set the clock.

1) Set the month

Press **▲** or **▼** repeatedly. Then, press **▶**.

2) Set the day

Press **▲** or **▼** repeatedly. Then, press **▶**.

3) Set the year

Press **▲** or **▼** repeatedly. Then, press **▶**. The day of the week will appear automatically.

4) Set the hour

Press **▲** or **▼** repeatedly. Then, press **▶**.

5) Set the minute

Press **▲** or **▼** repeatedly. Then, press **▶**.

6) Set AM or PM

Press **▲** or **▼** repeatedly.

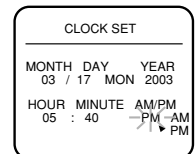

- To go back one step, press **◀**.

- 4 Start the clock by pressing **CLEAR/C.RESET** or **▶**.

PLAYBACK FUNCTION

NORMAL PLAYBACK

VCR

1 Insert a prerecorded tape. The VCR will turn on.

- If the safety tab has been removed, the VCR will start playback automatically.

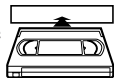

2 Turn on the TV and set the TV to channel 3.

- If noise appears, change the RF output channel of the VCR to channel 4 by pressing PLAY for 3 seconds during playback. Then select the same channel (CH4) on your TV. (See "RF OUTPUT CHANNEL" on page 13 for the detail.)

3 Begin playback by pressing PLAY.

- Tracking adjustment will be done automatically (Digital Tracking function) when you start playback. To adjust the tracking manually, press SKIP/CH. on the remote or CHANNEL (UP/DOWN) on the VCR.
- When a tape has reached the end, the VCR will rewind the tape to the beginning, and eject the tape.

4 To stop playback, press STOP.

- If no corresponding symbols appear on the display when you press buttons such as PLAY, RECORD, ►► or ◀◀, that means no cassette tape is in the VCR. Please insert a tape.

Counter Reset

- You can reset the counter by pressing CLEAR/C.RESET on the remote control twice.

STILL/SLOW

You can freeze the picture on TV screen by pressing PAUSE during playback.

- You can advance the picture one frame at a time by pressing PAUSE during the Still mode.
- You cannot manually adjust the tracking of a still picture. However, if the picture begins to vibrate vertically during the still mode, you can stabilize the picture by pressing CHANNEL (UP/DOWN).
- If the picture is distorted or rolling vertically, adjust the vertical hold control on your TV, if so equipped.
- You can watch in the slow motion by pressing SLOW during playback or the still mode.
- If a noise bar appears on the TV screen, you can reduce it by pressing CHANNEL (UP/DOWN).
- After the VCR has been in Still/Slow mode for 5 minutes, it will stop automatically to protect the tape and the video head from damage.
- To return to playback, press PLAY.

AUTO REPEAT PLAYBACK

VCR

This feature allows you to play a tape over and over.

1 Select main menu by pressing MENU.

2 Select "AUTO REPEAT" by pressing ▲ or ▼.

3 Begin auto repeat playback by pressing ► so that ON appears next to "AUTO REPEAT".

- If the on-screen menu still remains, CLEAR/C.RESET to exit the menu.
- To cancel the Auto repeat mode, press ► at step [3] so that OFF appears next to "AUTO REPEAT".

SEARCH FUNCTIONS

VCR

PICTURE SEARCH

If you want to skip or repeat a scene during playback, press ►► or ◀◀.

- Press it again and the VCR will now search at super high speed. (in the LP/SLP modes only).

INDEX SEARCH

An index mark will be assigned at the beginning of each recording you made. You may skip to a specific marked point by following the steps below.

1 Press SEARCH MODE so that the Index Search menu appears.

2 Enter the number of recordings you wish to skip by pressing ▲ or ▼ within 30 seconds.

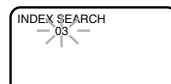

3 Press ► or ◀ to start index search.

- If you want to go in the forward direction, press ►.
- If you want to go in the reverse direction, press ◀.
- If you want to stop search function, press STOP.
- After index search, the VCR will play the tape automatically.

TIME SEARCH

This feature allows you to go to a specific point on a tape by entering the exact amount of time you wish to skip in order to reach the point.

1 Press SEARCH MODE 2 times so that the Time Search menu appears.

2 Enter your desired time to skip by pressing ▲ or ▼ within 30 seconds.

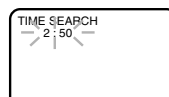

3 Press ► or ◀ to start time search.

- If you want to go in the forward direction, press ►.
- If you want to go in the reverse direction, press ◀.
- If you want to stop search function, press STOP.
- After time search, the VCR will play the tape automatically.

RECORDING FUNCTION

VCR

It may be UNLAWFUL to record copyrighted material without the consent of the copyright owner.

Accidental Erasure Prevention

To prevent accidental recording on a recorded cassette, remove its record safety tab. To record on it later, cover the hole with cellophane tape.



Before recording, make sure:

- The desired channel is selected by pressing Number on the remote control or CHANNEL (▲/▼). (If you connected the VCR to a cable box or satellite box as in "CONNECTING TO A TV WITHOUT A/V TERMINALS" on page 13, select channel 3 on your TV, and select the specific INPUT channel assigned by your cable box or your satellite box on the DVD/VCR COMBINATION UNIT. Then, select the channel you want to record with the cable box or the satellite box. In this case, you can ONLY record and view the SAME channel.)
- If noise appears, change the RF output channel of the VCR to channel 4 by pressing PLAY for 3 seconds during playback. Then select the same channel (CH4) on your TV.
- If noise appears, change the RF output channel of the VCR to channel 4 by pressing PLAY for 3 seconds during playback. Then select the same channel (CH4) on your TV.
- There is a tape with a safety tab in the VCR.
- The desired recording speed is selected in SP (standard play) or SLP (super long play) mode by pressing SPEED on the remote control.

Tape Speed	Recording/Playback Time		
	Type of tape	T60	T120
SP mode	1 hour	2 hours	2-2/3 hours
SLP mode	3 hours	6 hours	8 hours

Note

- You can not copy a DVD to a videotape.

NORMAL RECORDING

VCR

- 1 Begin the recording by pressing RECORD. The REC Light comes on.

- To temporarily stop recording or to resume it, press PAUSE. After the VCR has been in Pause mode for 5 minutes, it will stop automatically to protect the tape and the video head from damage.

- 2 Press STOP when the recording is completed.

Note

- When you wish to watch another program while recording, select desired channel on your TV. If noise appears press VCR/TV.
- This is not possible when using a cable box or satellite box.

OTR (One Touch Recording)

VCR

This feature allows you to set the recording length simply by pressing REC on the VCR.

- 1 Press REC to begin OTR. The TIMER light comes on. Change the recording length by pressing REC repeatedly.

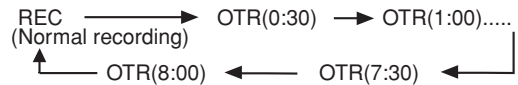

- If a tape ends during OTR, the VCR will stop, eject the tape, and switch to the DVD mode automatically as the TIMER REC light blinks. (If the DVD power is off, the VCR will become STANDBY status).
- When OTR is finished, the VCR turns off automatically. To use the VCR again, press T-SET on the remote, or STOP/EJECT on the DVD/VCR COMBINATION UNIT.

TIMER RECORDING

VCR

You may set the VCR to start recording while you are away. You can set eight programs to record on specific days, daily or weekly within 1 year period.

If you have not yet set the clock, "CLOCK SET" appears. If so, follow the steps [3] and [4] in "CLOCK SET UP" section on page 17. Then, set the timer recording.

- 1 Insert a tape with its safety tab into the DVD/VCR COMBINATION UNIT.
- 2 Select main menu by pressing MENU.

- 3 Select "TIMER PROGRAMMING" by pressing ▲ or ▼. Then, press ►. The set up screen is displayed.



- 4 Set the timer.

- To go back one step, press ◀.

1) Set the program number (1-8)

Program number which is not set up flashes. Press ▲ or ▼ repeatedly for the desired program number. Then, press ►.

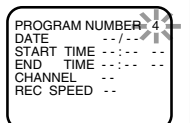

2) Set the frequency of the recording

For once: Press ▲ or ▼ to point to "ONCE".

For daily (Monday-Friday): Press ▲ or ▼ to point to "DAILY".

For weekly: Press ▲ or ▼ to point to "WEEKLY". Then, press ►.

```
PROGRAM NUMBER 4
▶ ONCE
  DAILY
  WEEKLY
```

3) Set the date

First, press ▲ or ▼ for the month.

Then, press ►. Next, press ▲ or ▼ for the day. Then, press ►.

```
ONE TIME PROGRAM
PROGRAM NUMBER 4
DATE 05/12 MON
START TIME 07:30 PM
END TIME 08:30 PM
CHANNEL 11
REC SPEED SP
```

4) Set the start time

First, press ▲ or ▼ for the hour.

Then, press ►. Next, press ▲ or ▼

for the minute. Then, press ►. And

then, press ▲ or ▼ for AM or PM. Then, press ►.

```
ONE TIME PROGRAM
PROGRAM NUMBER 4
DATE 05/12 MON
START TIME 07:30 PM
END TIME 08:30 PM
CHANNEL 11
REC SPEED SP
```

5) Set the end time

Follow the instructions of "Set the start time" to set the end time.

```
ONE TIME PROGRAM
PROGRAM NUMBER 4
DATE 05/12 MON
START TIME 07:30 PM
END TIME 08:30 PM
CHANNEL 11
REC SPEED SP
```

6) Set the channel number

Press ▲ or ▼ repeatedly for the desired channel number. Then, press ►.

If you connected the DVD/VCR COMBINATION UNIT to a cable box or satellite box as in "DVD/VCR TO TV CONNECTION" on page 13, select the DVD/VCR to channel 3 or 4 the same channel as RF output channel of the DVD/VCR. Then, select the channel you want to record with the cable box or satellite box.

Leave the cable box or satellite box on for timer recording.

```
ONE TIME PROGRAM
PROGRAM NUMBER 4
DATE 05/12 MON
START TIME 07:30 PM
END TIME 08:30 PM
CHANNEL 11
REC SPEED SP
```

7) Set the tape speed

Press ▲ or ▼ repeatedly for the desired tape speed. Then, press ►.

```
ONE TIME PROGRAM
PROGRAM NUMBER 4
DATE 05/12 MON
START TIME 07:30 PM
END TIME 08:30 PM
CHANNEL 11
REC SPEED SP
SLP
```

5 To set another program, repeat step [4]. To exit, press CLEAR/C.RESET.

6 Press T-SET to set the timer.

- The TIMER light on the DVD/VCR COMBINATION UNIT comes on. **TIMER RECORDING WILL NOT BE ACTIVATED UNLESS YOU PRESS T-SET.**

HINTS FOR TIMER RECORDING

VCR

- If there is a power failure or the VCR is unplugged for more than 30 seconds, the clock setting and all timer settings will be lost.

- If a tape ends during TIMER RECORDING, the VCR will stop, eject the tape, and switch to the DVD mode automatically as the TIMER light blinks. (If the DVD power is off, the VCR will become STANDBY status).
- If a tape is not in the VCR or does not have a safety tab, the TIMER light flashes and timer recording will not operate. Please insert a recordable tape.
- When all timer recordings are finished, the TIMER light will flash. To use the VCR again as usual, press T-SET to disable the flashing TIMER light, then press VCR/TV to select the VCR position. Select either VCR or DVD mode, then continue with the other features as described in this manual.
- When timer recordings are set, the TIMER light will come on. To use the VCR as usual until the time for the recording, press T-SET so that TIMER light disappears. Press VCR/TV to choose the VCR position. Select either VCR or DVD mode, then continue with the other features as described in this manual.

If you want to use the DVD player during a VCR timer recording or while the TIMER light is on or flashes.

- You can use the DVD player while the TIMER light is on or flashes, or during a timer recording. Press POWER to turn on the DVD. Press DVD on the remote control to choose DVD mode, then continue with the other DVD features as described in this manual. You don't have to set the TIMER off to use the DVD only.

TO STOP AN AUTOMATIC TIMER PROGRAM ALREADY STARTED

Press STOP/EJECT on the DVD /VCR COMBINATION UNIT.

TO CHECK, CORRECT, OR CANCEL AN AUTOMATIC TIMER PROGRAM

1 Press T-SET.

- If the DVD output mode is selected, you have to switch it to the VCR mode by pressing the VCR on the remote control or the OUTPUT on the VCR.

2 Select main menu by pressing MENU.

3 Select "TIMER PROGRAMMING" by pressing ▲ or ▼. Then, press ►.

4 Select the program number you want to check by pressing ▲ or ▼.

- The details of the selected program appears on the TV screen.
- Go to the digit you want to change by pressing ► or ◀. Then, enter correct numbers by pressing ▲ or ▼.
- You may cancel the entire program by pressing ◀ while the program number flashes.

5 Press CLEAR/C.RESET to exit.

6 Press T-SET to return to timer stand-by mode.

SPECIAL FEATURES

COPYING A VIDEO TAPE

VCR

You can make copies of video tapes made by friends or relatives for your enjoyment.

You can not copy a DVD to a videotape.

Warning:

Unauthorized recordings of copyrighted video tapes may be an infringement of copyright laws.

Connect the recording VCR (this unit), the playing VCR (another source) and your TV using the following diagram.

- You can use the AUDIO/VIDEO input jacks on the front panel of the DVD/VCR instead of using the jacks on the back.

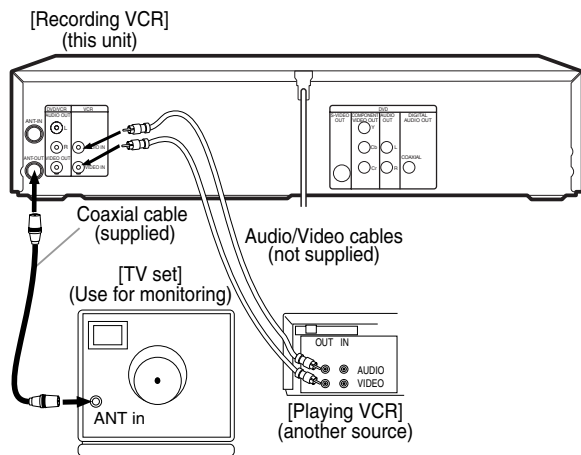

1 Insert a pre-recorded tape into the playing VCR.

2 Insert a tape with a safety tab into the recording VCR.

3 Press **SPEED** on the recording VCR to select the desired recording speed (SP/SLP).

4 Select the "L1" or "L2" position on the recording VCR.

- When you use the A/V input jacks on the back of the DVD/VCR, select "L1" position by pressing [0], [0], [1] on the remote control or the CHANNEL (UP/DOWN).
- When you use the A/V input jacks on the front of the DVD/VCR, select "L2" position by pressing [0], [0], [2] on the remote control or the CHANNEL (UP/DOWN).

5 Press **REC** on the recording VCR.

6 Begin playback of the tape in the playing VCR.

- For best results during dubbing, use the VCR's front panel controls whenever possible. The remote control might affect the playing VCR's operation.
- Always use video-quality shielded cables with RCA-type connectors. Standard audio cables are not recommended.
- You can use a video disc player, satellite receiver, or other audio/video component with A/V outputs in place of the playing VCR.

TO MONITOR THE RECORDING

1 Turn on the TV and set the TV to channel 3.

- If noise appears, change the RF output channel of the VCR to channel 4 by pressing **PLAY** for 3 seconds during playback. Then select the same channel (CH4) on your TV. (See "RF OUTPUT CHANNEL" on page 13 for the detail).

2 Press **VCR/TV** on the recording VCR.

AUTO REWIND

When a tape reaches the end during recording, playback, or fast-forward, the tape will automatically rewind to the beginning. After rewinding finishes, the VCR will eject the tape and switch itself off.

- The VCR will not rewind the tape automatically during timer recording or One Touch Recording.

REAL TIME TAPE COUNTER

- This shows the elapsed recording or playback time in hours, minutes, and seconds. (The displayed time will not change during blank portions of the tape.)
- The indication will appear when the tape is rewound further than "0:00:00" on the tape counter.

PLAYING A DISC

BASIC PLAYBACK

DVD-V CD

Getting started

- Turn on the power of the TV, amplifier and any other components which are connected to the DVD.
- Make sure the TV and audio receiver (commercially available) are set to the correct channel.
- Select DVD mode by pressing DVD on the remote control or output on the front panel.

1 Press POWER.

2 Press OPEN/CLOSE to open disc loading tray.

3 Place the chosen disc in the tray, with the label facing up.

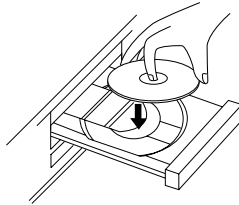

4 Press PLAY.

- The tray will close automatically, and playback will then start from the first chapter or track of the disc. If the playback does not start automatically, press PLAY.
- When you playback the DVD which a title menu is recorded, it may appear on the screen. In this case, refer to “TITLE MENU” on page 23.

5 Press STOP twice to stop playback.

Notes

- A “prohibited icon” may appear at the top-right on the TV screen during operation, warning that a prohibited operation has been encountered by the DVD or the disc.
- With DVDs that use titles for playback program signals, playback may start from the second title, or it may skip these titles.
- During the playback of a two layered disc, pictures may stop for a moment. This happens when the 1st layer switches to the 2nd layer. This is not a malfunction.

GENERAL FEATURES

DVD may contain menus to navigate the disc and access special features. Press the appropriate Number buttons or use Arrow (▼/▲/◀/▶) to highlight your selection in the DVD main menu and press ENTER to confirm.

Note

- Unless stated, all operations described are based on remote control use. Some operations can be carried out using the menu bar on the TV screen.

PAUSE

DVD-V CD

1 During playback, press PAUSE.

- Playback will pause and sound will be muted.

2 To continue playback, press PLAY.

DISC MENU

DVD-V

- 1 Press MENU.
 - The DVD main menu will appear.
- 2 If the feature is not available,  symbol may appear on the TV screen.
- 3 If disc menu is available on the disc, audio language, subtitle options, chapters for the title and other options will appear for selection.
- 4 Press Arrow (▼/▲/◀/▶) to select an item, and ENTER to confirm selection.

TITLE MENU

DVD-V

- 1 Press TITLE.
 - The title menu will appear.
- 2 If the feature is not available,  symbol may appear on the TV screen.
- 3 Press Arrow (▼/▲/◀/▶) to select an item, and ENTER to confirm selection.

CALLING UP A MENU SCREEN DURING PLAYBACK

For DVD-Vs

- Press MENU to call up the DVD menu.
- Press TITLE to call up the title menu.

Note

- Contents of menus and corresponding menu operations may vary between discs. Refer to the manual accompanying the disc for details.

STEP BY STEP PLAYBACK

DVD-V

- 1 During playback, press PAUSE.
 - Playback will pause and sound will be muted.
- 2 The disc goes forward by one frame each time PAUSE is pressed.
- 3 To exit step by step playback, press PLAY.

RESUME

DVD-V

CD

- 1 During playback, press STOP.
 - Resume message will appear on the TV screen.
- 2 Press PLAY, playback will resume from the point at which playback was stopped.
 - To cancel resume, press STOP twice.

FAST FORWARD/REVERSE SEARCH

DVD-V

CD

MP3

- 1 During playback, press ►► or ◀◀ repeatedly to select the required forward or reverse speed: x2, x8, x50, x100.
 - For audio CDs, the speed is fixed at x16.
 - For MP3, the speed is fixed at x8.
- 2 To return to normal playback, press PLAY .

SLOW FORWARD / SLOW REVERSE

DVD-V

- 1 During playback, press PAUSE.
- 2 Press ►► or ◀◀.
- 3 Press ►► or ◀◀ repeatedly to select the required speed: 1/16, 1/8, 1/2 of the normal playback.
- 4 To return to normal playback, press PLAY.

ZOOM

DVD-V

The Zoom function allows you to enlarge the video image and to pan through the enlarged image.

1 Press ZOOM during playback.

- Playback will continue.

2 Press ZOOM repeatedly to select the required zoom factor: x2, x4 or OFF.

3 Use the Arrow (▲/▼/◀/▶) to move the zoomed picture across the screen.

4 To exit zoom mode, press ZOOM to OFF.

Notes

- Zooming function does not work while disc menu is shown.
- x4 zoom is not available on some discs.

TRACK

CD

There are three ways to begin playback on an Audio CD at a specific Track.

Using the Number buttons

1 Press the Number buttons to enter the desired Track number.

- Playback will start at the selected track.
- For single digit tracks (1-9), press a single number (eg. track 3, press 3).
- To play track 26, press +10, 2, 6 on the Number buttons.

Using SEARCH MODE

1 Press SEARCH MODE.

- The track search display appears.

2 Within 30 seconds, select a desired track number using the Number buttons.

- For single digits press 0 first.
- Playback will start at the selected track.

Using SKIP ◀◀▶▶

During playback, press SKIP ▶▶ to move the next track. Press it repeatedly to skip subsequent tracks. Press SKIP ◀◀ to go back to beginning of the current track. Press it repeatedly to go to the previous tracks.

- If SKIP is pressed while the playback is paused, the playback will be paused again after skipping to the next track.

Note

- SKIP ◀◀ ▶▶ are not available when playback is stopped.

TITLE / CHAPTER SEARCH

DVD-V

1 Press SEARCH MODE once for the Chapter search, twice for the Title search during playback.

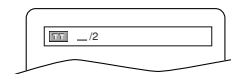

2 Enter the desired chapter/title number using the Number buttons.

- Playback will start at the selected Chapter or Title.
- Press CLEAR/C.RESET to erase the incorrect input.
- For single digits press 0 first.

TIME SEARCH

DVD-V

CD

1 During playback, press SEARCH MODE three times (CD: twice) to display the Time Search on the TV screen.

2 Within 30 seconds, enter a desired disc time using the Number buttons.

- Playback will start at the specified time.
- Press CLEAR/C.RESET to erase the incorrect input.

REPEAT

REPEAT are available only during playback.

REPEAT TITLE / CHAPTER

DVD-V

To activate the repeat function, press REPEAT during playback.

- The repeat mode changes as described below every time you press the button.



Notes

- Repeat Title/Chapter is not available with some scenes.
- The REPEAT setting will be cleared when moving to other title or chapter.

REPEAT TRACK

CD

To activate the repeat function, press REPEAT during playback.

- The repeat mode changes as described below every time you press the button.



Notes

- Track repeat setting will be cleared when moving to other track.
- Repeat playback does not function during A-B REPEAT playback.

A-B REPEAT

DVD-V CD

1 Press A-B REPEAT at your chosen starting point.

- A- appears briefly on the TV screen.

2 Press A-B REPEAT again at your chosen end point.

- A-B appears briefly on the TV screen, and the repeat sequence begins.

3 To exit the sequence, press REPEAT A-B.

Notes

- The A-B REPEAT section can only be set within the current title (for DVDs), or current track (for audio CDs).
- A-B REPEAT is not available with some scenes in DVD.
- To cancel the A point which was set, press CLEAR/C.RESET.
- A-B REPEAT playback does not function during title, chapter, track or all repeat playback.

PROGRAM

CD

You may determine the order in which tracks will play.

1 In stop mode, press MODE.

- The PROGRAM screen will appear.

2 Press **▲** or **▼** to select a track, then press ENTER.

- Press CLEAR/C.RESET to erase the most recently entered program.

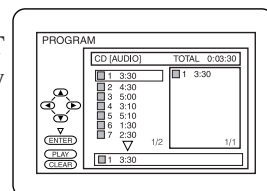

3 Press PLAY to play the programmed tracks.

Notes

- While the program is being played back, the STOP works as follows.
- Press STOP once and then PLAY again, playback will restart from the point where STOP was pressed. (Program continued)
- Press STOP twice and then PLAY again, playback will restart from the track in the usual way. (Program cleared)
- Up to 99 programs can be entered.
- If you like to repeat the current track in the program, press REPEAT repeatedly until TRACK appears during playback. If you like to repeat the entire program press REPEAT repeatedly until ALL appears during playback.

RANDOM PLAYBACK

CD

This shuffles the playing order of tracks instead of playback in the sequence.

1 In stop mode, press MODE twice.

- RANDOM screen appears.

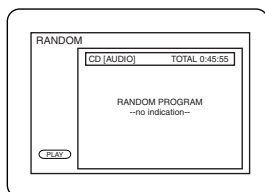

2 Press PLAY to start random playback.

Note

- If you like to repeat the current track in the random selection, press REPEAT repeatedly until TRACK appears during playback. If you like to repeat the entire random selection press REPEAT repeatedly until ALL appears during playback.

MP3 PLAYBACK

MP3

When a CD with MP3 files is inserted in the DVD/VCR, the MP3 menu will appear on the TV screen.

1 In stop mode, press Arrow (▲/▼) to select the desired group track.

- If a group is selected, press or ENTER to go on to the track selection screen. Press Arrow (▲/▼) to choose a track, then press or ENTER.
- If a track is selected, press or ENTER to start playing tracks. Starting from the one you've just chosen the subsequent tracks will be played.
- Choose FIRST PLAY to start playback from the beginning of the listed tracks.
- Press TITLE to return to the first item.

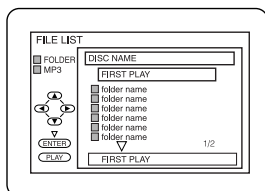

2 Press STOP to stop playback.

Notes

- Folders are known as Groups; files are known as Tracks.
 - MP3 files are accompanied by icon.
 - Maximum of 255 folders can be recognized.
 - Maximum of 256 files can be recognized.
 - Up to 8 hierarchies can be created.
- This player recommends the use of files recorded at the below specifications:
- Sampling frequency: 44.1kHz or 48kHz
 - Constant bit rate: 112kbps ~ 320kbps.

ON-SCREEN INFORMATION

MP3

You can check the MP3 files during playback.

1 Press DISPLAY.

- The name of the file currently in play will be displayed.

2 Press DISPLAY again to show the track number, the repeat status, and the playback status at the top of the screen.

- will be displayed when repeat play has been selected.

T - indicates Track repeat

G - indicates Group (folder) repeat

A - indicates Disc repeat

3 Press DISPLAY again to exit.

TRACK SELECTION

MP3

1 Press SEARCH MODE during playback.

- The FILE LIST will appear.

2 Select a desired track using Arrow (▲/▼/◀/▶).

- Press when you want to go to the next hierarchy.
- Press when you want to go back to the previous hierarchy.

3 Press PLAY to start playing.

Notes

- Press SEARCH MODE to exit.
- Some selections may take a while to be recognized.

RANDOM PLAYBACK

MP3

- 1 Press **MODE** twice while playback is stopped.
- 2 Press **PLAY** to play the tracks in random order.

PROGRAM

MP3

This feature allows you to program a mp3 disc to play in a desired sequence.

- 1 Press **MODE** during playback is stopped.
 - The PROGRAM screen will appear.
- 2 Press Arrow (▲/▼) to select a track, then press **ENTER**, to save it in a program.
 - Press **CLEAR/C.RESET** to erase the incorrect input.
- 3 Press **PLAY** to start programmed playback.

AUDIO LANGUAGE

DVD-V

The DVD/VCR allows you to select a language during DVD disc (if multi language available) playback.

- 1 Press **AUDIO** during playback.
- 2 Press **AUDIO** repeatedly to select your desired language.

STEREO SOUND MODE

CD

- 1 Press **AUDIO** repeatedly during playback to select between STEREO, L-CH or R-CH.
 - STEREO - both right and left channels are active (stereo)
 - L-CH - only left channel is active
 - R-CH - only right channel is active

Note

- If the Virtual Surround setting is 1 or 2, the sound mode will be fixed to STEREO, and can not be changed.

SUBTITLE LANGUAGE

DVD-V

The DVD allows you to select a language for subtitles during DVD disc (if available) playback.

- 1 Press **SUBTITLE** during playback.
- 2 Press **SUBTITLE** repeatedly to select your desired subtitle language.
 - The subtitle language will be displayed on the display bar at the top of the screen.
- 3 To turn off subtitles, press **SUBTITLE** repeatedly until **OFF** appears.

Notes

- Pressing **AUDIO** may not work on some DVDs with multiple audio languages (e.g. DVDs which allow audio language setting on the disc menu).
- Some discs allow audio language setting/subtitle language setting on the disc menu. (Operation varies between discs, so refer to the manual accompanying the disc.)
- If the desired language is not shown after pressing **SUBTITLE** several times, the disc does not have subtitles in that language.
- If you choose a Language that has a 3 letter language code, the code will be displayed every time you change the Subtitle language setting. If you choose any other languages, '---' will be displayed instead. (Refer to page 31.)

CAMERA ANGLE

DVD-V

Some DVD discs contain scenes which have been shot simultaneously from various angles. You can change the camera angle when the (📷) icon appears on the screen.

- 1 Press **ANGLE** during playback.
 - The selected angle will be displayed on the display bar at the top of the screen.
- 2 Press **ANGLE** repeatedly to select your desired angle.

CHANGING THE ON-SCREEN DISPLAY

DVD-V CD

You can check the information about the current disc by pressing DISPLAY on the remote control.

For DVD-Vs

1 Press DISPLAY during playback to show current Chapter.

- The elapsed and remaining playing time of the current chapter will be displayed.

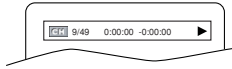

2 Press DISPLAY again to show current Title.

- The elapsed and remaining playing time of the current title will be displayed.

3 Press DISPLAY third time.

- The BIT RATE and the current repeat setting will be displayed.
- If you are playing a dual layered disc, the layer number will also be displayed (L0: Layer 0 is playing, L1: Layer 1 is playing).

4 Press DISPLAY the fourth time to remove the display.

For audio CDs

1 Press DISPLAY during playback, the current Track will be displayed on the TV screen.

- The elapsed and remaining playing time of the current track will be displayed.

2 Press DISPLAY again to show current Total Track.

- The elapsed and remaining playing time of the current total track will be displayed.

3 Press DISPLAY third time to remove the display.

PARENTAL CONTROL

DVD-V

Parental Control limits the disc viewing that exceed your settings. (with a password or playback will stop.) This feature allows you to prevent discs with alternative scenes from being played by your children.

PARENTAL LEVEL

Parental Level allows you to set the rating level of your DVD discs. Playback will stop if the disc's ratings exceed the level you set.

1 Press SETUP in STOP mode.

2 Press ► to select CUSTOM, then press ENTER.

3 Press Arrow (◀/▶) to select PARENTAL, then press ENTER.

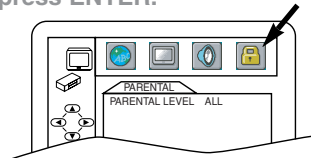

4 Enter your four-digit password then press ENTER.

5 Press Arrow (▲/▼) to select PARENTAL LEVEL, then press ENTER.

6 Press Arrow (▲/▼) to select the desired level.

7 Press SETUP to exit

Notes

- When doing this for the first time, enter any 4 digits. (except for 4737) That number will be used as the password. (in the event you forget the password, see below.)
- To change the password, press Arrow (▲/▼) to select CHANGE at step 5, then press ENTER. Enter the four-digit password, then press ENTER.
- With some DVDs, it may be difficult to find if they are compatible with parental lock. Be sure to check if the parental lock function operates in the way that you have set.
- Record the password in case you forget it.

IF YOU FORGET THE PASSWORD

1 Press 4, 7, 3, 7 at step 4. Then enter your new password.

- Password will be cleared and parental level will be set to ALL.

2 Proceed the above Steps 5-7 again.

CONTROL LEVELS

- **ALL**

All parental lock is cancelled.

- **Level 8**

DVD software of any grade (adult/general/children) can be played back.

- **Levels 7 to 2**

Only DVD software intended for general use and children can be played back.

- **Level 1**

Only DVD software intended for children can be played back, with those intended for adult and general use prohibited.

MARKER SETUP SCREEN

DVD-V CD

Use markers to memorise your favourite places on a disc.

1 Press **SEARCH MODE** twice (CD: three times) during playback.

- The display screen and Markers will appear on the TV screen.

2 Press **Arrow (◀/▶)** to select 1, 2, 3, 4, 5, 6, 7, 8, 9, or 10 and ensure that “- : - : - -” appears in the display.

3 When reaches the desired point, press **ENTER**.

- The Title or Track and elapsed playing time will appear in the TV screen.

4 To return to the Marker later, press **SEARCH MODE** four times (CD: three times) during playback and **Arrow (◀/▶)** to choose the desired marker, then press **ENTER**.

Notes

- Opening the disc tray or turning off the power or select AC at step 2 and press **ENTER** will erase all Markers.
- To clear a marker, using **Arrow (◀/▶)**, position the cursor on to the marker number to be cleared and press **CLEAR/C.RESET**.
- You can mark up to 10 points.

5 Press **SEARCH MODE** or **RETURN** to exit.

DVD SETUP

AUDIO SETTING

Choose the appropriate Audio settings for your equipment as it only affect during the playback of DVD discs.

1 Press **SETUP** in **STOP** mode.

2 Press **▶** to select **CUSTOM**, then press **ENTER**.

- **CUSTOM** mode will appear.

3 Press **Arrow (◀/▶)** to select **AUDIO**, then press **ENTER** to confirm.

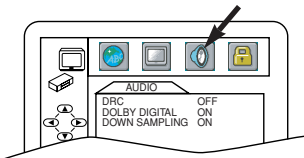

4 Press **Arrow (▲/▼)** to select the below items, then press **ENTER**.

DRC (Dynamic Range Control):

- To compress the range of soft to loud sounds.
- The default setting is **OFF**.

Dolby Digital: **QUICK**

Set to **On** when the unit is connected to a Dolby Digital Receiver.

(**ON**: Outputs a Dolby Digital Signal)

(**OFF**: Convert the Dolby Digital to PCM (2channel))

- The default setting is **ON**.

DOWN SAMPLING:

- Set to **ON** when outputting in 48 kHz.
- The default setting is **ON**.

When playing disc with copyright Protection

- If you select **OFF**, copyright protection will be activated and sound will be down sampled at 48kHz.

4 Press **SETUP** to exit.

BLACK LEVEL SETTING

DVD-V

Adjust the Black Level Settings to make the black parts of the picture brighter.

- 1 Press **MODE** during playback.

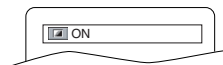

- 2 Press **ENTER** to switch ON/OFF.

ON: Makes the dark parts brighter.

OFF: Shows the original picture as recorded.

- 3 Press **MODE** twice or **RETURN** to exit.

VIRTUAL SURROUND

DVD-V CD MP3

You can enjoy stereophonic visual space on your existing stereo system.

- 1 Press **MODE** twice (CD/MP3: once) during playback.

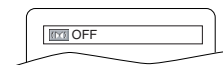

- 2 Press **ENTER** to set it 1 (Natural effect) or 2 (Emphasized effect) or OFF.

- 3 Press **MODE** or **RETURN** to exit.

Note (for CD play only)

- Virtual Surround will not be effective if the sound mode is set to something other than STEREO.

DISPLAY SETTING

DVD-V

You can change certain aspects of the DVD display screens, and on-screen messages.

- 1 Press **SETUP** in STOP mode.

- 2 Press **▶** to select **CUSTOM**, then press **ENTER**.

- **CUSTOM** mode will appear.

- 3 Press **Arrow (◀/▶)** to select **DISPLAY**, then press **ENTER** to confirm.

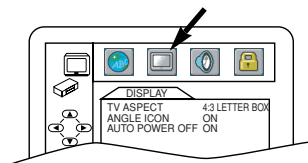

- 4 Press **Arrow (▲/▼)** to select the below items, then press **ENTER**.

TV ASPECT: **QUICK**

- Press **Arrow (▲/▼)** for an item selection, then press **ENTER**.
- Select 4:3 LETTER BOX for a black bars appears on top and bottom of the screen.
- Select 4:3 PAN & SCAN for a full height picture with both sides trimmed.
- Select 16:9 WIDE if a wide-screen TV is connected to the DVD/VCR.
- The default setting is 4:3 LETTER BOX.

ANGLE ICON:

- Press **ENTER** repeatedly to turn Angle icon ON or OFF.
- The default setting is ON.

AUTO POWER OFF:

- Press **ENTER** repeatedly to turn Auto Power off ON or OFF.
- The default setting is ON and it will turn the DVD/VCR to off automatically after 35 minutes of no use.

- 5 Press **SETUP** to exit.

Notes

- Be sure to press **SETUP**, or the setting will not work.

LANGUAGE SETTING

DVD-V

Language options are not available with some discs.

1 Press **SETUP** in **STOP** mode.

2 Press **▶** to select **CUSTOM**, then press **ENTER**.

• **CUSTOM** mode will appear.

3 Press Arrow (**◀/▶**) to select **LANGUAGE**, then press **ENTER** to confirm.

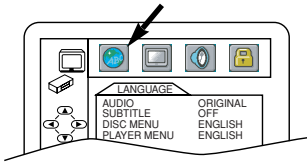

4 Press Arrow (**▲/▼**) to select the next items, then press **ENTER**.

• If you want to return to **LANGUAGE SETTING MENU**, press Arrow (**◀**).

AUDIO:

• Sets the audio language.

SUBTITLE:

• Sets the subtitle language.

DISC MENU:

• Sets the language for **DVD** menu.

PLAYER MENU: **QUICK**

• Sets the language for the On-screen display.

5 Press Arrow (**▲/▼**) to select a setting, then press **ENTER**.

• If **OTHER** is selected on the **AUDIO**, **SUBTITLE** or **DISC MENU** screen, press four-digit number to enter the code for the desired language. (Refer to the language code list below.)

• Only the languages supported by the disc can be selected.

6 Press **SETUP** to exit.

Note

• Language Setting for Audio and Subtitle is not available with some discs. Then use the Audio and the Subtitle button. Details are on page 27.

Language	Code	Language	Code	Language	Code	Language	Code
A-B		I-K		O-R		T	
Abkhazian	4748	Frisian	5271	Malay	5965	Somali	6561
Afar	4747	Galician	5358	Malayalam	5958	Spanish [SPA]	5165
Afrikaans	4752	Georgian	5747	Maltese	5966	Sundanese	6567
Albanian	6563	German [GER]	5051	Maori	5955	Swahili	6569
Amharic	4759	Greek [GRE]	5158	Marathi	5964	Swedish [SWE]	6568
Arabic	4764	Greenlandic	5758	Moldavian	5961		
Armenian	5471	Guarani	5360	Mongolian	5960	Tagalog	6658
Assamese	4765	Gujarati	5367	Nauru	6047	Tajik	6653
Aymara	4771	Hausa	5447	Nepali	6051	Tamil	6647
Azerbaijani	4772	Hebrew	5569	Norwegian [NOR]	6061	Tatar	6666
Bashkir	4847	Hindi	5455			Telugu	6651
Basque	5167	Hungarian [HUN]	5467	O-R		Thai	6654
Bengali; Bangla	4860			Oriya	6149	Tibetan	4861
Bhutani	5072	I-K		Oromo(Afan)	6159	Tigrinya	6655
Bihari	4854	Icelandic [ICE]	5565	Panjabi	6247	Tonga	6661
Bislama	4855	Indonesian	5560	Pashto; Pushto	6265	Tsonga	6665
Breton	4864	Interlingua	5547	Persian	5247	Turkish [TUR]	6664
Bulgarian	4853	Interlingue	5551	Polish	6258	Turkmen	6657
Burmese	5971	Inupiak	5557	Portuguese [POR]	6266	Twí	6669
Byelorussian	4851	Irish [IRI]	5347	Quechua	6367		
C-E		Italian [ITA]	5566	Rhaeto-Romance	6459	U-Z	
Cambodian	5759	Japanese [JPN]	5647	Romanian [RUM]	6461	Ukrainian	6757
Catalan	4947	Javanese	5669	Russian [RUS]	6467	Urdu	6764
Chinese [CHI]	7254	Kannada	5760	S		Uzbek	6772
Corsican	4961	Kashmiri	5765	Samoan	6559	Vietnamese	6855
Croatian	5464	Kazakh	5757	Sangho	6553	Volapuk	6861
Czech	4965	Kinyarwanda	6469	Sanskrit	6547	Welsh	4971
Danish [DAN]	5047	Kirghiz	5771	Scots Gaelic	5350	Wolof	6961
Dutch [DUT]	6058	Kirundi	6460	Serbian	6564	Xhosa	7054
English [ENG]	5160	Korean [KOR]	5761	Serbo-Croatian	6554	Yiddish	5655
Esperanto	5161	Kurdish	5767	Sesotho	6566	Yoruba	7161
Estonian	5166	L-N		Setswana	6660	Zulu	7267
F-H		Laothian	5861	Shona	6560		
Faroese	5261	Latin	5847	Sindhi	6550		
Fiji	5256	Latvian; Lettish	5868	Singhalese	6555		
Finnish [FIN]	5255	Lingala	5860	Siswat	6565		
French [FRE]	5264	Lithuanian	5866	Slovak	6557		
		Macedonian	5957	Slovenian	6558		
		Malagasy	5953				

If you choose a Language that has a 3 letter language code, the code will be displayed every time you change the Audio or Subtitle language setting on page 27. If you choose any other languages, '---' will be displayed instead. (3 letter language code is written in bracket.)

TROUBLESHOOTING GUIDE

If the DVD/VCR COMBINATION UNIT does not perform properly when operated as instructed in this Owner's Manual, check the player consulting the following checklist.

D V C R	PROBLEM	CORRECTIVE ACTION
D V C R	No power.	<ul style="list-style-type: none"> • Make sure the power plug is connected to an AC outlet. • Make sure the power is turned on.
	The player does not respond to the remote control.	<ul style="list-style-type: none"> • Check if the power plug is connected to an AC outlet. • Check the batteries in the remote control. • Aim the remote control directly at the remote sensor. If necessary, remove all the obstacles between the sensor and the remote. • You have to be within 23 feet of the player. • Check if the correct mode is selected. If not switch the mode by pressing DVD or VCR ,whichever you need, on the remote control. • Check if a cassette tape is in the VCR.
V C R	Timer recording is impossible.	<ul style="list-style-type: none"> • Make sure the timer recording is set correctly. • Make sure the power is off. • Make sure the VCR clock is set correctly.
	Cannot go into Record mode.	<ul style="list-style-type: none"> • Make sure the tape has a safety tab. If needed, cover the hole with cellophane tape. • Put he player in VCR mode. Press VCR on the remote control so that the green VCR OUTPUT light is lit.
	Playback picture is partially noisy	<ul style="list-style-type: none"> • Adjust tracking control for a better picture by pressing CHANNEL (UP/DOWN) on the DVD/VCR COMBINATION UNIT.
	Cannot view a tape but the audio is OK	<ul style="list-style-type: none"> • Head cleaning may be necessary. Refer to "AUTO HEAD CLEANING". • Make sure the VCR is not in the Menu mode.
	No, or poor, playback picture.	<ul style="list-style-type: none"> • Change the RF output channel to CH4. Then select the same channel on the TV. • Fine tune your TV.
	TV programs cannot be seen normally.	<ul style="list-style-type: none"> • Re-check the ANT. IN and ANT. OUT connections. See page 13. • Press VCR/TV. • Press VCR on the remote control to put it in the VCR mode. Check if the green VCR OUTPUT light is lit. Then, set it to the TV position by pressing VCR/TV.
	Video or color fades in and out when making a copy of a video tape.	<ul style="list-style-type: none"> • You cannot copy a copyrighted video tape. You are experiencing copy guard protection.
Cannot remove the tape.	<ul style="list-style-type: none"> • Check if the player is in the VCR mode. If not, press VCR on the remote control to switch the mode. 	
D V D	No picture.	<ul style="list-style-type: none"> • Connect the video cables firmly. • Insert a correct video disc that plays on this player. • Press DVD on the remote control. Check if the DVD OUTPUT Light is lit. Then try other DVD feature.
	Disc cannot be played.	<ul style="list-style-type: none"> • Insert the disc. • Clean the disc. • Place the disc correctly, with the label side up. • Cancel the parental lock or change the control level.
	No sound.	<ul style="list-style-type: none"> • Connect the audio cables firmly. • Turn the power of the audio component on. • Correct the audio output settings. • Correct the input settings on the audio component.
	No DTS audio is output.	<ul style="list-style-type: none"> • This player does not support DTS audio. This is not a malfunction.
	Distorted picture.	<ul style="list-style-type: none"> • Connect the player directly to the TV. • There are some cases where pictures may be slightly distorted, which are not a sign of a malfunction. • Although pictures may stop for a moment, this is not a malfunction.
	Audio or subtitle language does not match the set up	<ul style="list-style-type: none"> • The selected language is not available for audio or subtitles on the DVD. This is not a malfunction
	The camera angle cannot be changed	<ul style="list-style-type: none"> • The DVD does not contain sequences recorded from different camera angles. This is not a malfunction
	Audio or subtitle language cannot be changed	<ul style="list-style-type: none"> • The DVD does not contain audio source or subtitles in the selected language. This is not a malfunction.
	"Prohibited icon" appears on the screen, prohibiting an operation	<ul style="list-style-type: none"> • That operation is prohibited by the player or the disc. This is not a malfunction.

Notes

Some functions are not available in specific modes, but this is not a malfunction. Read the description in this Owner's Manual for details on correct operations.

- Playback from a desired track and random playback are not available during program playback.

MAINTENANCE

SERVICING

- Should your DVD/VCR COMBINATION UNIT become inoperative, do not try to correct the problem by yourself. There are no user-serviceable parts inside. Turn off, unplug the power plug, and take the unit to our Authorized Service Center.

CLEANING THE CABINET

- Use a soft cloth slightly moistened with a mild detergent solution. Do not use a solution containing alcohol, spirits, ammonia or abrasives.

CLEANING DISCS

- When a disc becomes dirty, clean it with a cleaning cloth. Wipe the disc from the center out. Do not wipe in a circular motion.
- Do not use solvents such as benzine, thinner, commercially available cleaners, detergent, abrasive cleaning agents or antistatic spray intended for analogue records.

CLEANING THE DISC LENS

- If the player still does not perform properly when it is operated while referring to the relevant sections and to “TROUBLESHOOTING GUIDE” in this Owner’s Manual, the laser optical pickup unit may be dirty. Consult your dealer or an Authorized Service Center for inspection and cleaning of the laser optical pickup unit.

DISC HANDLING

- Use discs which have the following logos on them. (Optical audio digital discs.)



- Handle the discs so that fingerprints and dust do not adhere to the surfaces of the discs.
- Always store the disc in its protective case when it is not used.

AUTO HEAD CLEANING

- Automatically cleans video heads as you insert or remove a cassette, so you can see a clear picture.
 - Playback picture may become blurred or interrupted while the TV program reception is clear. Dirt accumulated on the video heads after long periods of use, or the usage of rental or worn tapes can cause this problem. If a streaky or snowy picture appears during playback, the video heads in your DVD/VCR COMBINATION UNIT may need to be cleaned.
1. Please visit your local Audio/Video store and purchase a good quality VHS Video Head Cleaner.
 2. If a Video Head Cleaner does not solve the problem, consult our nearest Authorized Service Center.

NOTES:

- Remember to read the instructions included with the video head cleaner before use.
- Clean video heads only when problems occur.

Make your contribution to the environment!!!

- Used up batteries do not belong in the dust bin.
- You can dispose of them at a collection point for used up batteries or special waste. Contact your council for details.



SPECIFICATIONS

Product type:	DVD player with Video Cassette Recorder
Discs:	DVD video Audio CD Video Cassette tape
Converter output:	VHF Channel 3 or 4.
Power source:	127 V AC +/- 10%, 60 Hz +/- 0.5%
Power consumption:	24 W (standby: 7.0 W)
Operating temperature:	41°F (5°C) to 104°F (40°C)
Dimensions:	W 17-1/8" (435 mm) H 4" (99 mm) D 8-7/10" (218 mm)
Weight:	8.16 lbs (3.7 kg)

- **Designs and specifications are subject to change without notice.**
- **If there is a discrepancy between languages, the default language will be English.**

Free Manuals Download Website

<http://myh66.com>

<http://usermanuals.us>

<http://www.somanuals.com>

<http://www.4manuals.cc>

<http://www.manual-lib.com>

<http://www.404manual.com>

<http://www.luxmanual.com>

<http://aubethermostatmanual.com>

Golf course search by state

<http://golfingnear.com>

Email search by domain

<http://emailbydomain.com>

Auto manuals search

<http://auto.somanuals.com>

TV manuals search

<http://tv.somanuals.com>