

# **LCM0681TV**

## **Owner's Manual**

## **Important Notice**

It is unlawful in most jurisdictions for a person to drive a motor vehicle which is equipped with a television viewer or screen that is located in the motor vehicle at any point forward of the back of the driver's seat, or that is visible, directly or indirectly, to the driver while operating the vehicle. In the interest of safety, the LCM0681TV should never be installed where it will be visible, directly or indirectly, by the operator of the motor vehicle.

Please note that the state of Rhode Island forbids the installation of such a device in a motor vehicle.

## **Television Reception**

This entertainment system is designed primarily for viewing pre-recorded movies or playing video games. Television reception in a moving vehicle will be limited and in some areas will not be possible due to weak and variable signal strength. Television viewing in a stationary vehicle will result in an improvement, but may still be marginal due to strength. The quality of the picture will not be consistent with home TV reception. Reception may be affected by the weather and distance from the TV station. A weak signal may cause the picture to roll, be snowy, or cause some color loss.

Congratulations on your purchase of the Flexvision LCM0681TV drop down TV/Video monitor. The LCM0681TV has been designed to give you and your family many years of video entertainment in the mobile environment. Please read the directions that follow to familiarize yourself with the product and to ensure that you obtain the best results from your equipment. **Please note:** Installation options vary, see the individual owner's manuals for each component in your system to obtain a full understanding of each component's operation.

## **Safety Precaution**

For safety reasons, when changing video tapes it is recommended that the vehicle is not in motion, and that you do not allow children to unfasten seat belts to change tapes or make adjustments to the system. System adjustments can be accomplished using the remote control unit, while seat belts remain fastened. Enjoy your Flexvision entertainment system but remember- safety of all passengers remains the number one priority.

## **FEATURES**

- 6.8" TFT (Thin Film Transfer) Active Matrix LCD (Liquid Crystal Display) Monitor
- OSD (On Screen Display) for control of Picture Quality and Functions
- Full Function Remote Control
- Television Tuner
- Plug in RF Transmitter for wireless RF Headphones
- Remote Sensor eye
- Four Audio / Video Sources
- Headphone / Speaker Amplifier
- Two Headphone Jacks for Wired Headphones
- Built-In Dome lights
- Back-lit Controls for Low Light Operation

# FRONT PANEL FEATURE

## Figure 1

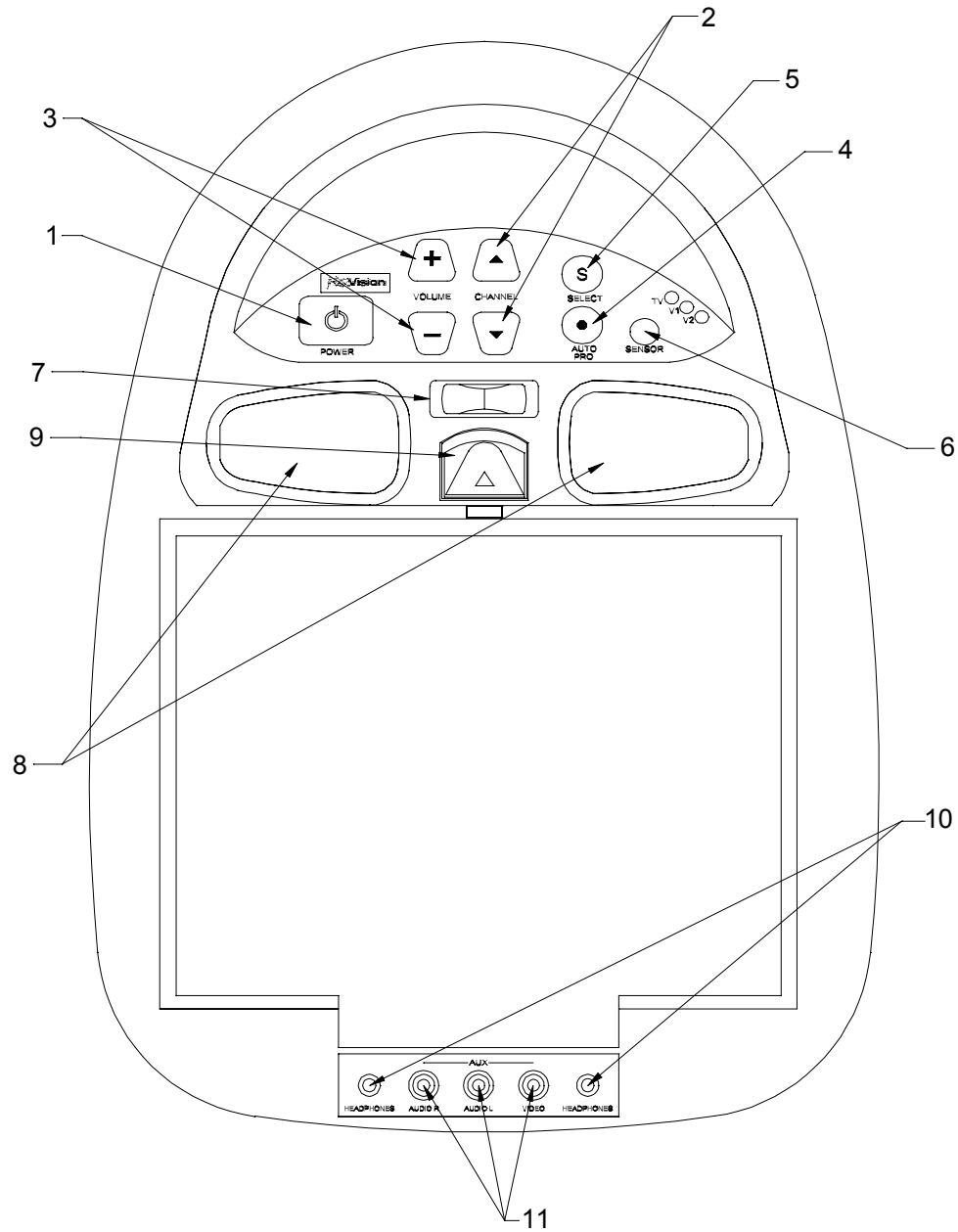

## FRONT PANEL FEATURES – See Figure 1

1. **Power Button-** (Bright red when system is ON, dim when system is OFF)
2. **Channel Up/Down-** Changes the TV channel
3. **Volume Up/Down-** Controls volume to headphone jacks and external speakers if connected.
4. **Auto Pro Switch-** Auto Program used to program local channels into TV memory. Press when vehicle is in a new location.
5. **Source Select-** Used to select one of the three A/V sources. The fourth source is plugged into the RCA jacks on the rear of the unit. V2 must be selected once something is plugged into the external jacks it over rides the previous source on V2.
6. **Sensor Eye-** Allows the remote control to operate the LCM0681TV's OSD system (On Screen Display), volume to wired headphone jacks (and optional external speakers), and for control of Video Cassette Player and other accessories.

### 7. Three Position Dome Light-

- Auto- Will automatically switch on the dome lights in conjunction with the vehicle's interior illumination. For the automatic position, shift the switch to the right.

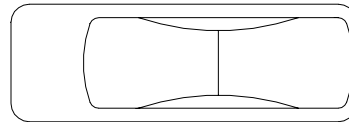

- OFF- The dome lights will be off in the middle position.

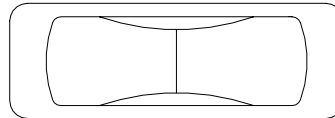

- ON- The switch must be in the left position for the dome lights to turn on.

## REMOTE CONTROL OPERATION

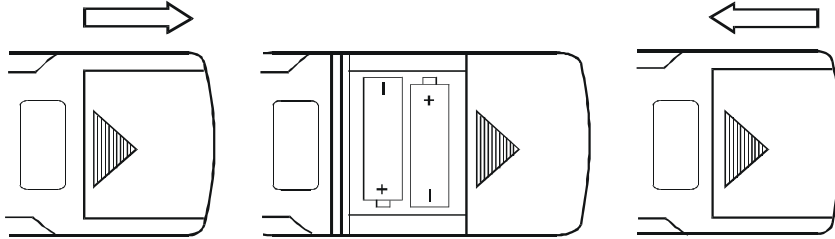

### BATTERY INSTALLATION

Before attempting to operate your Remote Control, install the batteries as described below.

- 1) Turn the remote control face down. Press down on the ridged area of the battery cover, and slide it off.
- 2) Install two “AAA” batteries as shown. Make sure that proper polarity (+ or -) is observed.
- 3) Slide the cover back until it clicks into position.

The remote control will operate the LCM0681TV, Flexvision Televisions and Video Cassette Players. It is not a universal remote control and will not control equipment from other manufacturers.

If a universal remote control is used with the LCM0681TV, choose the remote control encoding scheme for Action Televisions when programming the remote.

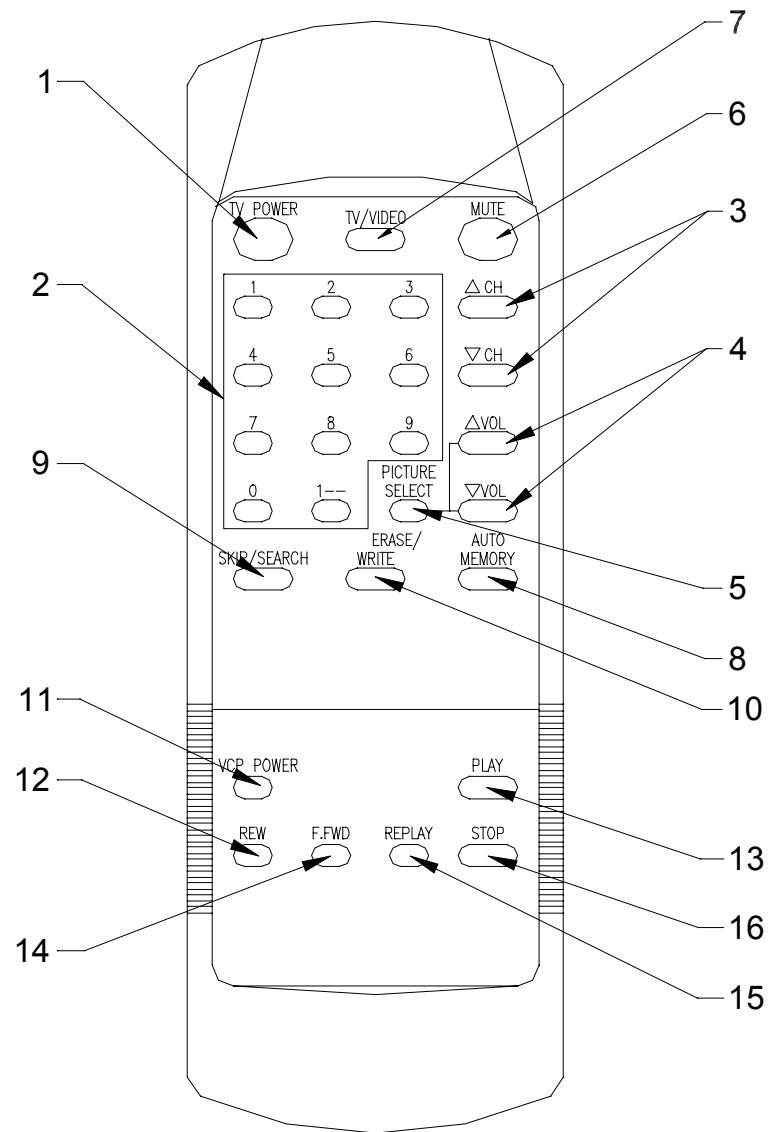

## Remote Controlled TV Functions

### 1. POWER ON/OFF

Press this button to turn the LCM0681TV on. The channel number or current video source will be displayed on screen, and the picture will appear in a few seconds. Press the button again to turn the LCM0681TV off.

### 2. DIRECT ACCESS (0-9) BUTTONS

Use these buttons to make a direct channel selection. The channel number chosen will be displayed on the screen for about 4 seconds. The direct access is carried out with 0-9 keys (0-99CH). The "1\_\_" key will not function as it is only used for cable channels above 99.

### 3. CHANNEL UP/DOWN BUTTONS

Use these buttons to advance to the next higher or lower channel. See also: SKIP/SEARCH BUTTON.

### 4. VOLUME UP/DOWN BUTTONS

Use these buttons to raise or lower the volume level of the headphone jacks or external speaker if installed. They are also used to make adjustments  
In picture select mode.

**Note:** These buttons will not affect the volume of wireless headphones or a wired RF modulator. When using these devices the volume must be adjusted with the headphone volume control or with your radio's volume control. (See page 11,

Headphones, or page 12, Wired FM Modulator).

### 5. PICTURE SELECT BUTTON

Each time this button is pressed, the screen picture adjustment display cycles through "adjustment bars" for CONTRAST, BRIGHTNESS, COLOR, and TINT. Once the desired adjustment bar is displayed, use the VOLUME UP/DOWN buttons to adjust the setting. The display will automatically turn off if no adjustments are made within 6seconds, or if any other button is depressed.

## **6. MUTE BUTTON**

Press this button to shut off the sound at the headphone stations. The screen will display the volume adjustment bar for 6 seconds, indicating that the sound has been turned off. Pressing the button again restores sound to the previously set level. The mute feature may also be released by pressing the VOLUME UP/DOWN buttons.

## **7. TV / VIDEO BUTTON**

Any video equipment connected to the AUDIO/VIDEO inputs can be used with the TV by pressing this button. Each time the button is pressed, the Audio/Video source will change in the following sequence VIDEO1, VIDEO2, and TV.

## **8. AUTO MEMORY BUTTON**

When the AUTO MEMORY BUTTON is depressed, all channels in TV mode are searched and tuned; all channels with video signals detected are automatically stored. Please refer to page 2 for more information on TV reception.

## **9. SKIP/SEARCH BUTTON**

This button selects between SKIP and SEARCH mode. In "SKIP mode" the TV only stops on channels that are programmed into memory when the CHANNEL UP/DOWN buttons are used. When the SKIP is turned off, the TV will only stop on all active channels.

## **10. ERASE/WRITE BUTTON**

When tuned to a channel press this button to store or erase the channel from memory. The stored channel numbers are displayed in "GREEN" on the screen, and the non-stored channels are in "RED". When skip mode is on, the LCM0681TV will tune to only the stored channels when using the CHANNEL UP/DOWN buttons.

## **REMOTE CONTROLLED VCP FUNCTIONS**

These features can only be used with an Audiovox Video Cassette Player, if this option was installed with your video package.



## 11. **POWER BUTTON**

This button is used to turn the VCP on and off.

## 12. **“REW” REWIND BUTTON**

If this button is pushed while the tape is stopped, the tape will rewind. If this button is pushed while the tape is playing, the VCP will go into rewind search mode. For more information consult the Audiovox VCP owner's manual.

## 13. **PLAY BUTTON**

Press this button to activate play mode while a tape is loaded into the VCP. This button may also be used to disengage search and pause modes. For more information, consult the VCP owner's manual.

## 14. **“FFWD” FAST FORWARD BUTTON**

If this button is pushed while the tape is stopped, tape will fast forward. If this button is pressed while the tape is playing, the VCP will go into fast forward search mode. For more information on the search feature of the VCP, consult the VCP owner's manual.

## 15. **REPLAY BUTTON**

Pressing this button will rewind the tape and immediately begin playback when the tape is fully rewound.

## 16. **STOP BUTTON**

Press this button to stop the tape.

## **CHANNEL TUNING SETUP**

In order to easily access all available channels, it may be necessary to perform channel auto-programming whenever the vehicle's geographic location has changed, i.e. city to city, weak signal area.

1. Press the AUTO MEMORY button on the remote control unit or the AUTO PROGRAM button on the flip down video unit. You will see the TV cycle through all it's channels. The built-in microprocessor will automatically note each channel that is actively broadcasting in your area.
2. (A) To tune only strong clear channels with the CHANNEL UP/DOWN buttons, press the SKIP/SEARCH button on the Remote Control Unit until "SKIP MODE ON" is displayed on the bottom of the screen. The TV will now tune only to strong active channels when the UP or DOWN buttons are used on the monitor or the remote control.

(B) To tune to weak or marginal channels with the CHANNEL UP/DOWN buttons, press the SKIP/SEARCH button on the Remote Control Unit until "SKIP MODE OFF" is displayed on the bottom of the screen. Tune to the desired channel using the CHANNEL UP/DOWN buttons or go directly to the channel by using the 0-9 buttons on the Remote Control.

3. To ERASE a channel, press the ERASE/WRITE button on the Remote Control Unit until "MANUAL MEMORY XX ERASE" is displayed on screen. To STORE a channel, press the button until the MANUAL MEMORY XX ADD is displayed on screen.

**Note:** Please refer to page 2 for more information on TV reception.

## **TURNING THE LCM0681TV ON OR OFF**

1. Sliding the screen release lock forward will unlock the LCD screen and it will drop down slightly. (Pivot the screen downward until a comfortable viewing angle is reached). After the unit has been turned on and displaying a picture, adjustment to the viewing angle can be made by pivoting the screen to optimize the picture quality. The internal friction detent will hold the screen in position while the system is in use.
2. Pressing the power button on the pod or remote will alternately turn the system on or off. When in use the internal back lighting will illuminate the controls.
3. Remember to turn the unit off and pivot the LCD to the locked position when not in use.

## OPERATION

### Overhead Dome Lights

The lights integrated into the LCM0681TV are controlled by a three position slide switch. Sliding the switch to the on position will turn the lights on. The off position will prevent the lights from turning on at all times, and the auto position will allow the lights to turn on and off with the vehicle's interior lighting. Do not leave the vehicle unattended with the dome light switch in the on position, as this could result in a discharged battery.

The switch is shown in the center position.

Light Switch

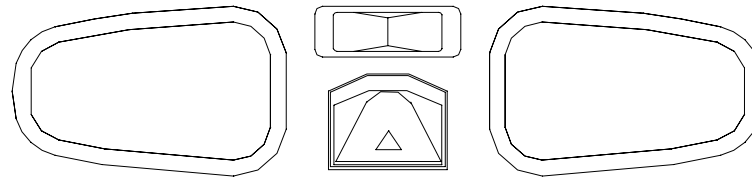

Screen Release

## Remote Sensor

The LCM0681TV incorporates an infrared sensor, which relays the signals from the remote control to allow the LCM0681TV and VCP to be controlled simply by pointing it's remote control at the remote sensor. This provides control of auxiliary equipment such as an Audiovox Video Cassette Player. The infrared sensor can relay signals from any manufacturer's remote control to it's respective component connected to the Video 1 and 2 inputs, such as a DVD player. In this case you must use the remote control supplied with the DVD player.

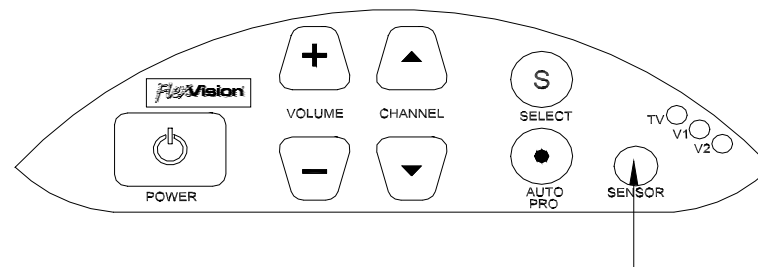

## External Auxiliary A/V Stereo Inputs (Aux Video 2)

These inputs are provided to facilitate the temporary connection of optional audio/video equipment, such as a camcorder or video game system. To play a source with these inputs, an RCA patch cord is required to connect the audio / video signals to their respective jacks. Mono audio sources will require the use of an RCA Y-cable (P/N 0892165) to connect to both right and left inputs, if patch cords are installed into the AUX inputs, the AUX INPUT 2 will be temporarily bypassed. Once the connections have been made, turn the LCM0681TV on and press the source button on the LCM0681TV or the TV / Video button on the remote control until "Video 2" is displayed on the screen. The unit will now play the audio and video signals from the accessory connected. The remote control will not operate the accessory components.

# LCM0681TV Jack Panel

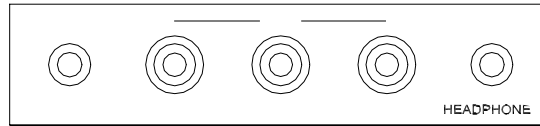

Revision C  
3/2001

Whenever the RF modulator is on, broadcast radio reception will be poor. Turning the remote mounted toggle switch off will allow for normal radio reception.

## **Video Output**

The LCM0681TV provides a video output for an optional video monitor(s). This output will provide a video signal that duplicates the signal displayed by the LCM0681TV to an additional monitor or video display. Please see your installer for more information.

## **Audiovox Video Cassette Player (Aux Video 1)**

In most installations a VCP will be connected to the "Video 1" input. To view a video cassette, turn the AVP7000/ AVP7285 on and press the source button on its control panel or the TV/Video button on the remote control unit until "Video 1" is displayed on the screen. The VCP may also be operated with the remote or the buttons on its face. Inserting a tape into the VCP will turn it on and automatically activate the play mode. If a rewind tape had been loaded into the VCP, prior to its activation press play on the VCP or the remote control to view the tape. For more information see the owner's manual accompanying your VCP.

# TYPICAL SYSTEM CONNECTIONS

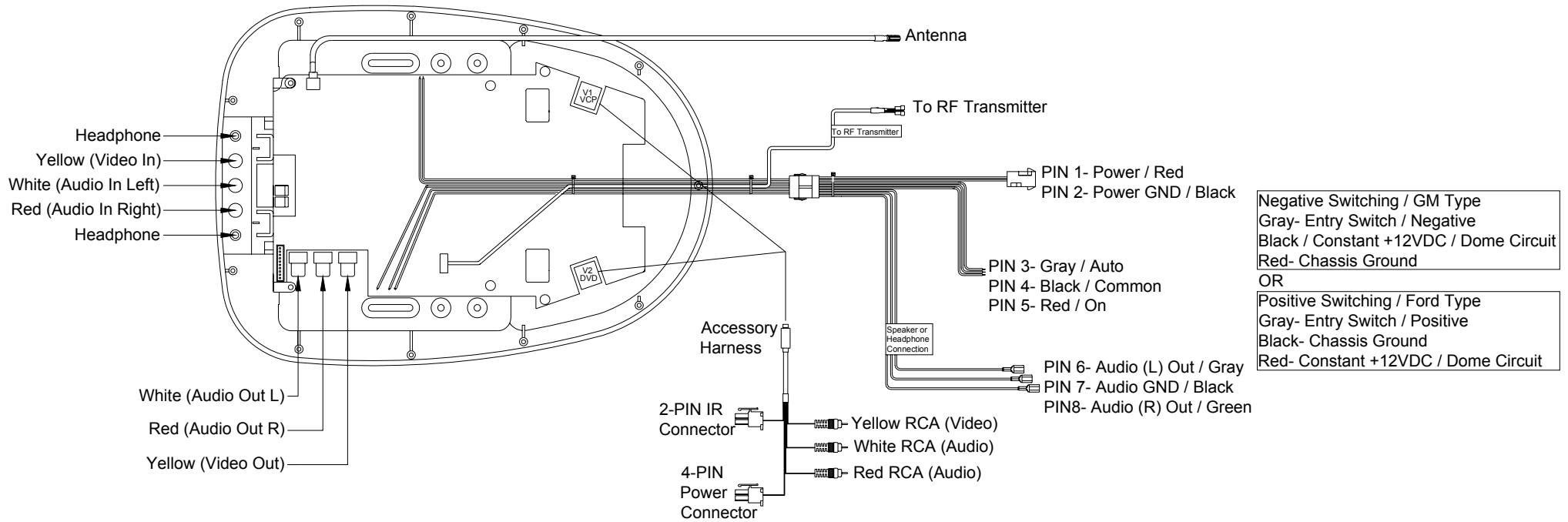

<b>Televisions</b>	
AVT-988 9" Color Television with Remote (12V)	AVT988
AVT-1498 13" Color Television with Remote (12V)	AVT1498
<b>VCP and DVD Players for use with TV's and LCD</b>	
AVP-7000 Video Cassette Player (12V)	AVP7000
AVP-7285 Video Cassette Player (12V)	AVP7285
Single Disc DVD Player	DVD2101
<b>Headphones</b>	
Wireless Headphones	WHRF01
Headphones with Pivoting Earcup	HP175
Headphones with volume Control on Cord	HP275
Studio Quality Headphones	HP375
<b>Miscellaneous</b>	
Remote Controls	Please Call
Wallmount Family Radio Service with 4 Handsets	FRS4WM
Replacement Handset	FRS100Y
12V Corded Vacuum	VAC21
Rechargeable Flashlight	AVF1
Window Mount TV Antenna	AN350
2-Amp Adapter for use with AVP7000 VCP	0891436
4-Amp Adapter for use with AVT988 9" and AVT1498 13" TV's	0891412
<b>Wallmount Radios</b>	
AM/FM Wallmount Manual Tune w/Cassette Player	AWM710
AM/FM Wallmount Electronic Tune w/Cassette Player	AWM820
AM/FM Wallmount Stereo w/CD Player	AWM930
<b>Marine</b>	
AM/FM Stereo w/CD Player	MS1000
AM/FM Weatherband Stereo w/Cassette Player	MS407
AM/FM Stereo w/Cassette Player (analog tune)	MS306

Revision C  
3/2001



AM/FM Stereo w/Cassette Player (analog tune)	MS220
Weatherproof Housing	MRH211
50 Watt 6 ½" Speakers (white/black)	AMS6
30 Watt 5" Speakers (white/black)	AMS5
30 Watt 4" Speakers	AMS4
Marine Radio Antenna	AN125

## Troubleshooting

-15-

## Specifications

PROBLEM	SOLUTION
Poor TV Reception	<ul style="list-style-type: none"> <li>• Perform auto programming of the tuner</li> <li>• Verify antenna condition.</li> <li>• NOTE: Due to the nature of TV signals, vehicle motion, direction the vehicle is facing, distance from the transmitter, nearby surroundings and weather may adversely affect TV reception. These conditions may result in the following: picture roll, "snowy" picture, or momentary loss of color. Please refer to page 2 for more information on TV reception.</li> </ul>
Poor radio reception (FM modulator installed)	<ul style="list-style-type: none"> <li>• Check the condition of the vehicle's radio antenna.</li> <li>• Verify that the antenna is fully raised</li> <li>• If a wired RF modulator has been installed, verify that it's switch is turned to the off position</li> </ul>
IR sensor inoperative	<ul style="list-style-type: none"> <li>• Verify that the batteries in the remote are fresh</li> <li>• Verify that the remote eye is not obstructed.</li> <li>• Verify that the infrared transmitter is affixed over the sensor eye of the component to be controlled</li> </ul>

LCD Back lighting	Edge Light Tube
Resolution	960 x 234
Pixels	224, 640
Operation Temperature	0 - 40° C
Storage Temperature	-20 - 80° C
Expected Back-light Life	10,000 Hours
Video Display System	NTSC
Audio Output	0.6W @ 16Ω



**A**UDIOVOX **S**PECIALIZED **A**PPPLICATIONS, L.L.C.

23319 Cooper Dr.

Elkhart, IN 46514

800-688-3135

[www.asaelectronics.com](http://www.asaelectronics.com)

Revision C  
3/2001

## Free Manuals Download Website

<http://myh66.com>

<http://usermanuals.us>

<http://www.somanuals.com>

<http://www.4manuals.cc>

<http://www.manual-lib.com>

<http://www.404manual.com>

<http://www.luxmanual.com>

<http://aubethermostatmanual.com>

Golf course search by state

<http://golfingnear.com>

Email search by domain

<http://emailbydomain.com>

Auto manuals search

<http://auto.somanuals.com>

TV manuals search

<http://tv.somanuals.com>